



High speed spindles for manual tool change

GMN Paul Müller Industrie GmbH & Co. KG
Äußere Bayreuther Str. 230 · D-90411 Nuremberg
Phone: +49 (0) 911-5691-0 · Fax: +49 (0) 911-5691-221
www.gmn.de

Spindle technology:

Phone: +49 (0) 911-56 91-240 · Fax: +49 (0) 911-5691-699
Mail: vertrieb.spi@gmn.de

Official GMN representative:

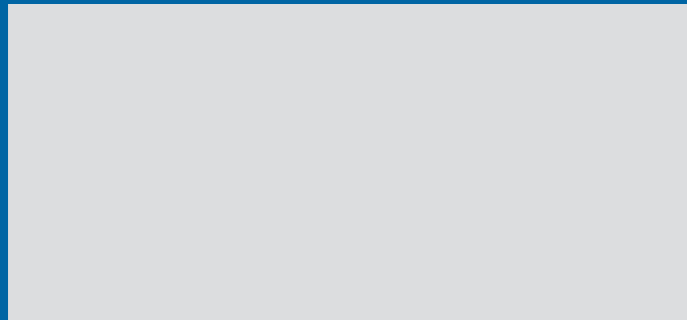

**Contents:****GMN spindle technology**

Years of experience ensure highest levels of precision
Page 4–5

GMN motor spindles

- High speed spindles
- for manual tool change
- for automatic tool change

Page 6

· High performance spindles

- Workpiece spindles
- Special designs

Page 7

Design features

Spindle bearing
Page 8–9

Lubrication
Page 10

Cooling
Page 11

Motors
Page 12–13

Drive systems
Page 14

Coolant supply through
the spindle shaft
Page 15

Maximum speeds
Page 16–17

Tool interfaces
Page 18–19

Legend and features
Page 20–21

**Technical data
Features****GMN**

High speed spindles
for manual
tool change
Page 22–69

- Tool interface:
GMN standard
- Series UHS
- Series HS
- Series HV-X
- Series HSX

Page 24–41

- Tool interface:
HSK interface
- Series HV-P
- Series HSP
- Series HSP.. g

Page 42–69

Dressing spindles
Page 70–71

GMN grinding quills

for GMN standard
· Grinding quills
· Semifinished products
· Shrink fit chucks
Page 72–75

for HSK interface
· Grinding quills
· Semifinished products
· Shrink fit chucks
Page 76

Accessories

Cables
Page 78

Plugs
Page 79

Lubrication units
Page 80–81

Cooling units
Page 82

Service

Page 83–85

Internet
Quality management
Page 86



GMN spindle technology

High speed spindles
for manual tool change

Based on its many years of experience in the development and production of high-quality machine components, GMN has chosen to specialize, within the field of spindle technology, in the production of long-life, high performance, high-speed spindles.

Emphasis is placed on the highest precision in the development and production of GMN high frequency spindles. This ensures their certification to international standards and produces consistent, outstanding quality characteristics with respect to stability and long service life in combination with high speed suitability.

The standardized model series offer a large selection of feature options to furnish effective spindle solutions for almost any field of application.

A myriad of special designs which have been successfully created by GMN confirm that optimal performance can be realized even for unusual structural specifications.

GMN Motor spindles

High speed spindles for manual tool change

Series: UHS, HS, HV-X, HSX, HV-P, HSP, HSP..g

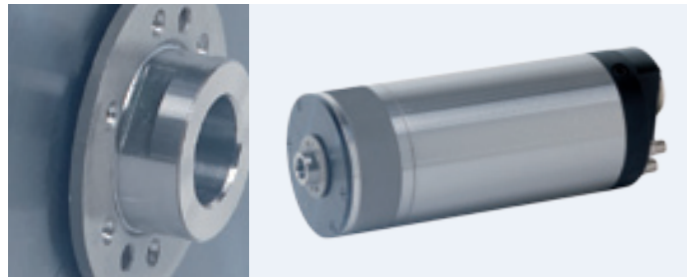

Housing Ø

- 80–230 mm

Speed

- max. 250,000 rpm

Power

- S1 max. 45 kW

Torque

- S1 max. 85 Nm

Motor

- Asynchronous motor
- Synchronous motor

Tool interface

- GMN standard
 - Internal taper with flat contact face
 - Fitting bores with flat contact face
- HSK-C

Tool change

- Manual

Lubrication

- Oil-air lubrication
- Permanent grease lubrication

Pages 22–69

High speed spindles for automatic tool change

Series: HC, HCS



Housing Ø

- 80–380 mm

Speed

- max. 90,000 rpm

Power

- S1 max. 120 kW

Torque

- S1 max. 450 Nm

Motor

- Asynchronous motor
- Synchronous motor

Tool interface

- HSK-A / B / E / T / F
- SK / BT
- PSC (Capto)

Tool change

- Automatic

Lubrication

- Oil-air lubrication
- Permanent grease lubrication

Catalog 2505

Special solutions on request

High performance spindles Tool spindles

Series: TSE, TSEV

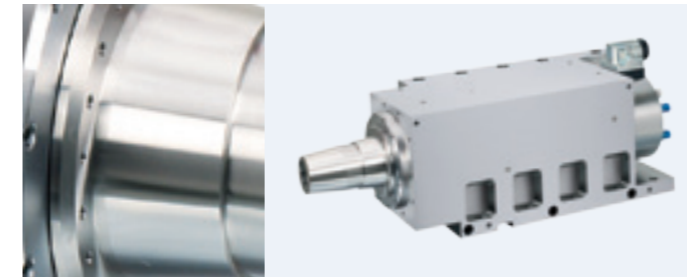

Housing Ø

- According to customer specification

Power

- S1 max. 350 kW

Torque

- S1 max. 1,750 Nm

Motor

- Asynchronous motor
- Synchronous motor

Tool interface

- Standardized tool interfaces
- According to customer specification

Tool change

- Manual
- Automatic

Lubrication

- Oil-air lubrication
- Permanent grease lubrication

Feature options

- Automatic balancing systems
- A/E sensor
- Shaft clamping for lathe work
- Vibration sensor
- Shaft growth sensor

Application examples

- Dressing spindles
- External-rotor motor grinding spindles
- Grinding spindles

GMN spindles in this series are fabricated on request to customer specifications

High performance spindles Special design

Series: ASE, HPD, WSE, ...

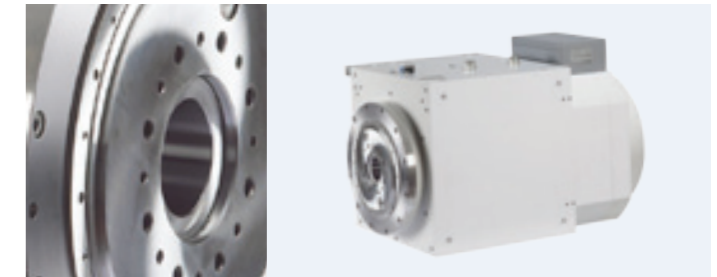

Housing Ø

- According to customer specification

Power

- S1 max. 350 kW

Torque

- S1 max. 1,750 Nm

Motor

- Asynchronous motor
- Synchronous motor

Tool interface

- Standardized tool interfaces
- According to customer specification

Tool change

- Manual
- Automatic

Lubrication

- Oil-air lubrication
- Permanent grease lubrication

Application examples

- Workpiece spindles
- Test stand motor
- High speed pump motor (helium, hydrogen)
- Energy-recovery generators
- Centrifuges

GMN spindles in this series are fabricated on request to customer specifications

Spindle bearing

GMN high precision ball bearings

Use of the highest quality components is the basis for the outstanding performance and long service life exhibited by GMN products.

Almost all spindles are equipped with GMN high precision ball bearings. These ensure reliable operation, smooth running and long service life.



Spindle technology from GMN is the result of the highest demands on quality – from development to production. Minimal tolerances for dimension, shape and running accuracy produce maximum performance capability, long service life and are defined by international (ISO 492) and national (DIN 620) standards.

GMN high precision ball bearings are produced in precision classes P4–P2 as well as ABEC 7–ABEC 9. GMN precision classes HG (high accurate) and UP (ultra precision) attain still greater levels of accuracy with even lower dimensional tolerances.

GMN hybrid ball bearings

Hybrid ball bearings are characterized by a combination of materials; bearing steel (inner and outer rings) and ceramic (balls).

The material-based characteristics of ceramic balls (in comparison to bearings with steel balls) offer clear performance improvements in machine operation, especially under critical conditions.



Material

Ceramic: Silicon nitride Si_3N_4

Material characteristics

- Low affinity to 100Cr6
- Low friction coefficient
- Low heat conductivity
- Corrosion resistance
- Non magnetic
- Electrically insulating

Characteristics of ceramics (silicon nitride) Si_3N_4 and bearing steel (chrome steel) 100Cr6

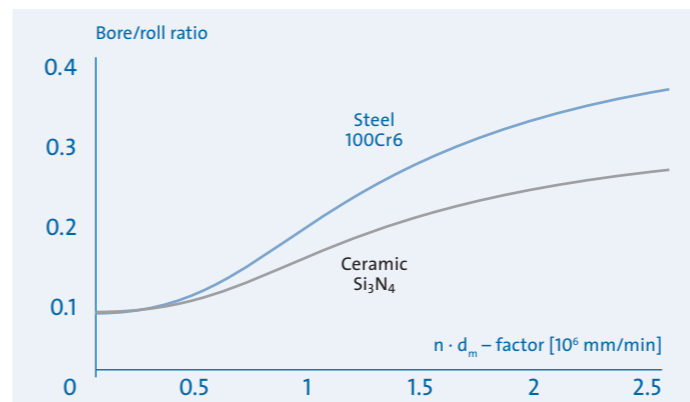
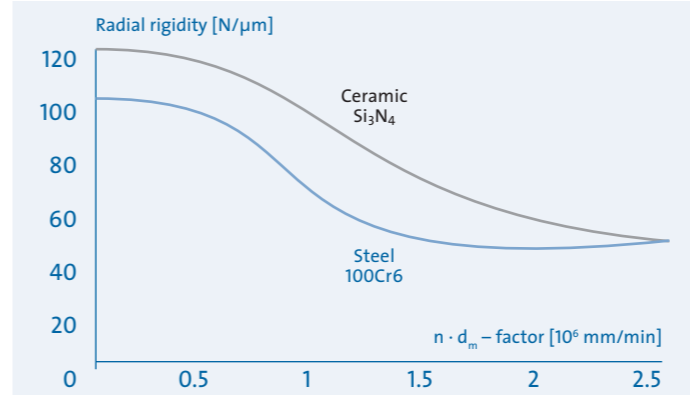
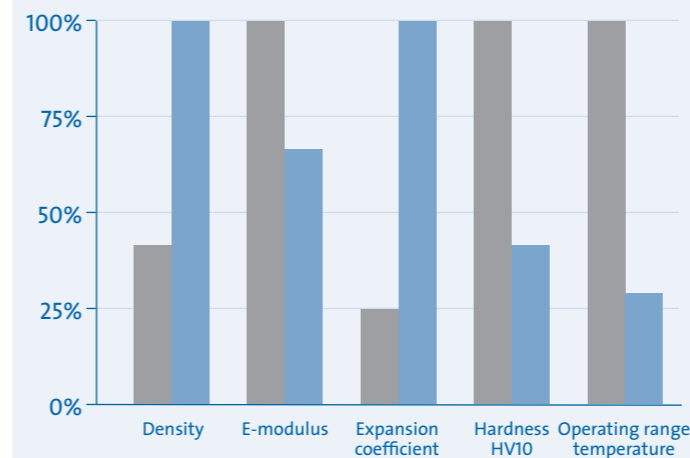

Advantages

Longer service life

Because of their material characteristics, hybrid bearings attain more than twice the service life of steel bearings. Machine operation time is significantly increased.

Higher speeds

Due to their tribological characteristics and lower mass forces, speed increases – in comparison to bearings with steel balls – of up to 30% can be attained.

Low-cost lubrication

The maximum speed for grease and oil lubrication is increased. Therefore grease lubrication can frequently be used instead of cost-intensive oil lubrication.

Higher rigidity

The characteristics of the materials improve both, radial and axial rigidity. The advantages are increased accuracy and a higher frequency for critical resonance.

Improved processing accuracy

Higher bearing rigidity, reduced thermal expansion and lower vibration excitation make it possible to achieve maximum processing accuracy.

Lubrication

Permanent grease lubrication with air purge

GMN grease-lubricated spindle bearings ensure reliable, maintenance free operation over the bearing's entire service lifetime.

The high-performance greases selected by GMN to lubricate bearings are optimized in quantity and quality for the service lifetimes of the installed GMN ball bearings.

A re-lubrication of the spindle bearing is not necessary.

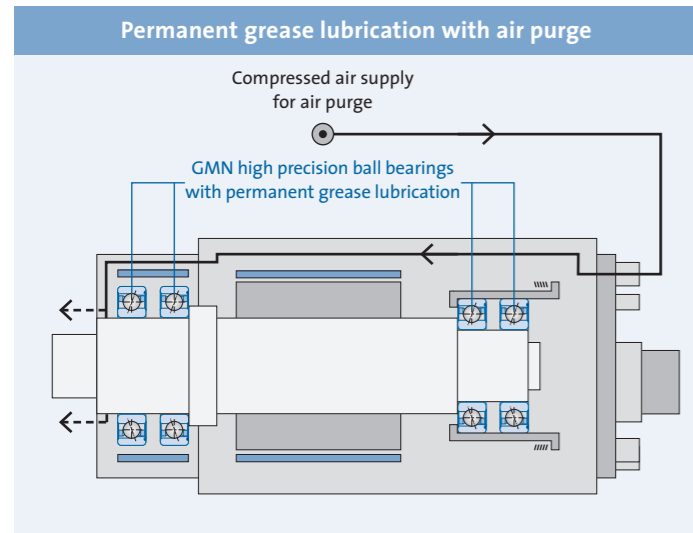

Permanent grease lubrication is characterized by low technical overhead and low life-cycle costs:

- Maintenance free
- Simplified system design
- Reduced operating costs (no oil consumption)
- No oil residues
- Environmentally friendly

Air purge (standard)

GMN standard series spindles with permanent grease lubrication are equipped with an air purge.

- Protection against spindle contamination

Air purge

A continuous supply of compressed air through the ring gap between shaft and housing seals the working side of the spindle against contamination by abrasive particles and liquids – and also ensures long service life even under harsh operating conditions.



Oil-air lubrication

Oil-air lubrication provides a specific supply of lubricant to the spindle bearing and is particularly well suited for very high speeds.

The lubricant is introduced at intervals and evenly dispersed to the lubrication points by a continuous stream of air.

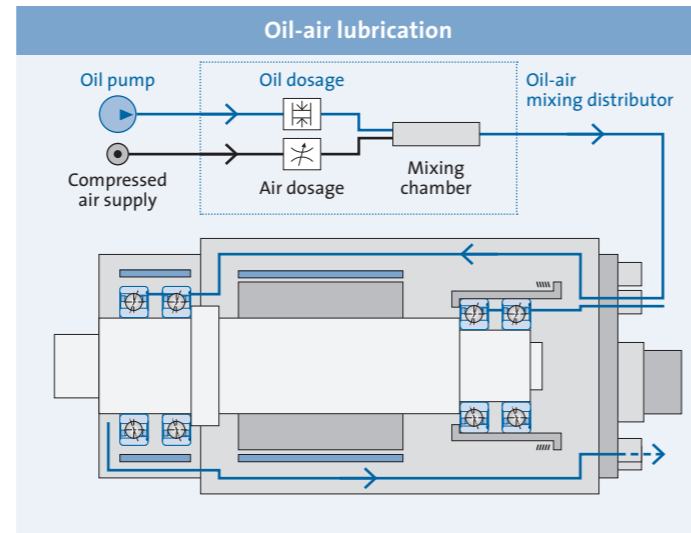

Oil-air lubrication guarantees utmost effectiveness with respect to consumption and lubricating effect at maximum speeds:

- Minimum friction losses
- Low heat development
- High operating security
- Quantity-regulated supply of lubricant
- Low oil consumption
- Low oil fog formation
- Low material and maintenance overhead (oil cooling and oil filtering not necessary)

Air purge (optional)

GMN spindles with oil-air lubrication are available with an optional air purge.

- Protection against spindle contamination
- Minimized oil escape

GMN lubrication units for simultaneous or separate regulation of the oil supply to as many as 4 spindles (page 80).

Cooling

Motor and bearing cooling

GMN high-speed spindles are equipped with an effective liquid cooling system.

Cooling jackets in the vicinity of shaft bearings and on the spindle motor minimize increases in operating temperature, especially those increases caused by bearing friction and motor energy losses.

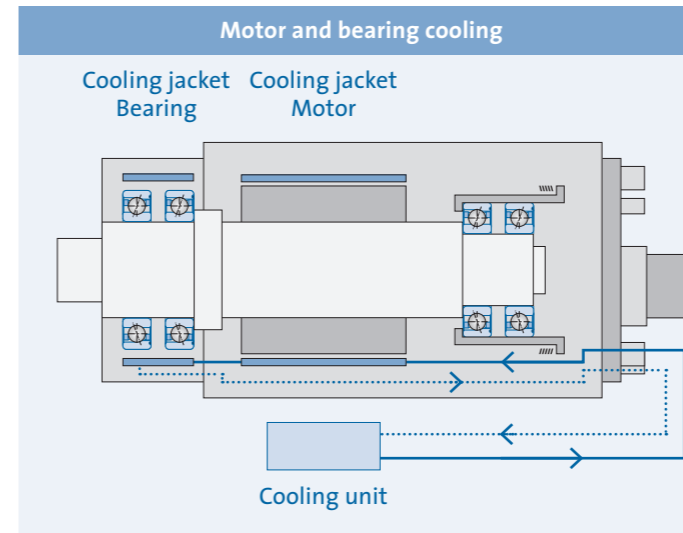

The reduction of operationally-induced heat development increases available spindle output performance, ensures maximum productivity and high processing quality.



Coolant temperature

The spindle's maximum output performance is reached within a specified coolant temperature range of 20 °C to 25 °C.

The actual performance attainable depends on the coolant's temperature and the medium used.

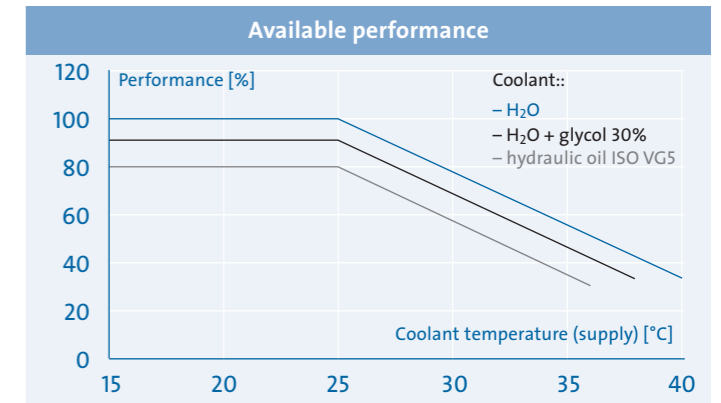

High processing accuracy

Keeping coolant temperature differences small reduces axial shaft displacement and improves processing accuracy.

GMN cooling units with high regulation accuracy are available as accessories (page 82).

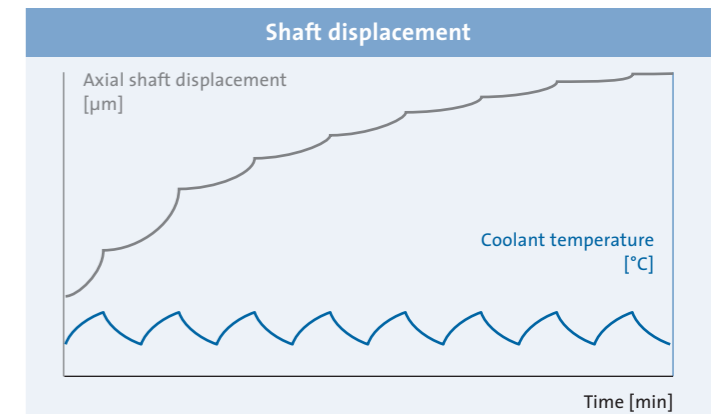

Motors

Requirements

Motor spindles with improved performance, rigidity and reliability are the essential prerequisites for economical milling production in many fields of application.

Depending on the processing task, it is important that a broad spectrum of different tools can be employed to the full extent of their performance capabilities:

Large tools demand high power at relatively low speeds, whereas a relatively low power demand is often sufficient for small tools.

These diverse requirements can be substantially covered by a single spindle model with GMN high-speed spindles. They provide – depending on model size – high torque and thus make it possible to achieve high processing performance even in the low speed range.

This is made possible by asynchronous and synchronous motors especially designed for this field of application as well as by efficient liquid cooling of the spindles. The motors have high power density and achieve a very good efficiency rating.

Power and torque characteristics

In this catalog, GMN offers high speed spindles in a broad spectrum of model sizes and power ratings.

Various motor performance characteristics are available to meet your requirements.

Models with a large weak-field area are an economical solution when the power demand in the upper speed range is not very high.

Example:

The HV-P 150 – 45000 spindle has two possible motor designs:

Power S6-60% [kW]		
at speed [min ⁻¹]	HV-P 150-45000/25	HV-P 150-45000/36
21,000	25	25
30,000	22	36
45,000	12	36
Input power S6-60% [kVA]		
	40	57

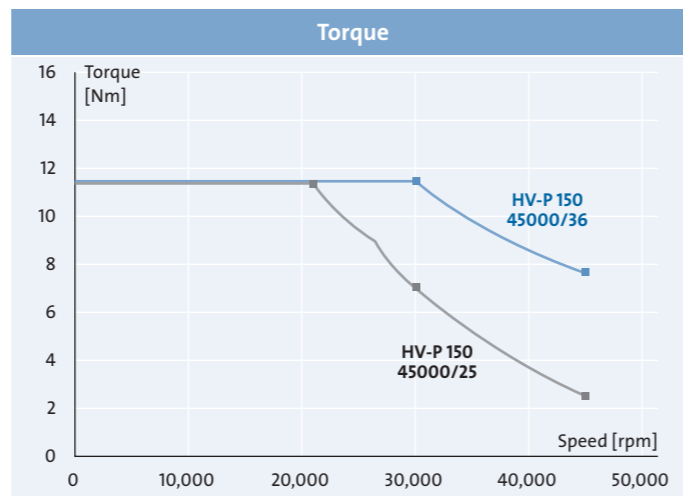
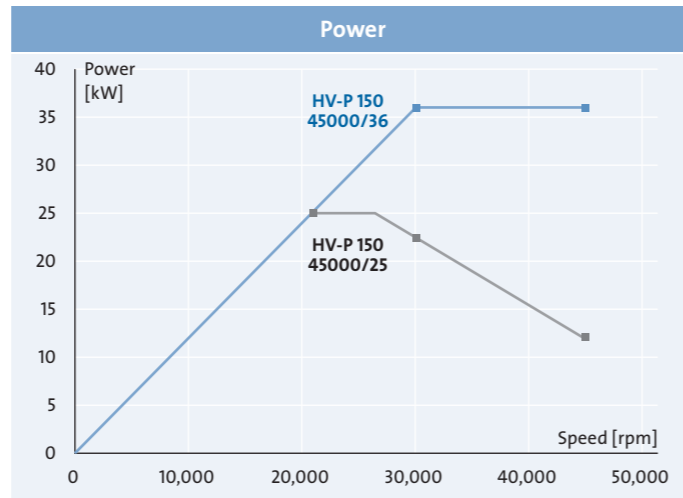

Synchronous motor with permanent magnet rotor

Where high demands are made on the spindle's performance capabilities, or for very high speeds (UHS spindles), GMN optionally employs synchronous motors with permanent magnet rotors.

- Very high power and torque density
- Low rotor losses (no slip) reduce load-dependent heat development in critical areas of the spindle.
- The permanent magnet rotor permits realization of very rigid spindle shafts with high critical speed.
- Appropriate CFRP bandaging make it possible to achieve very high rotor circumferential speeds (circumferential speed up to 260 m/s for UHS spindles).

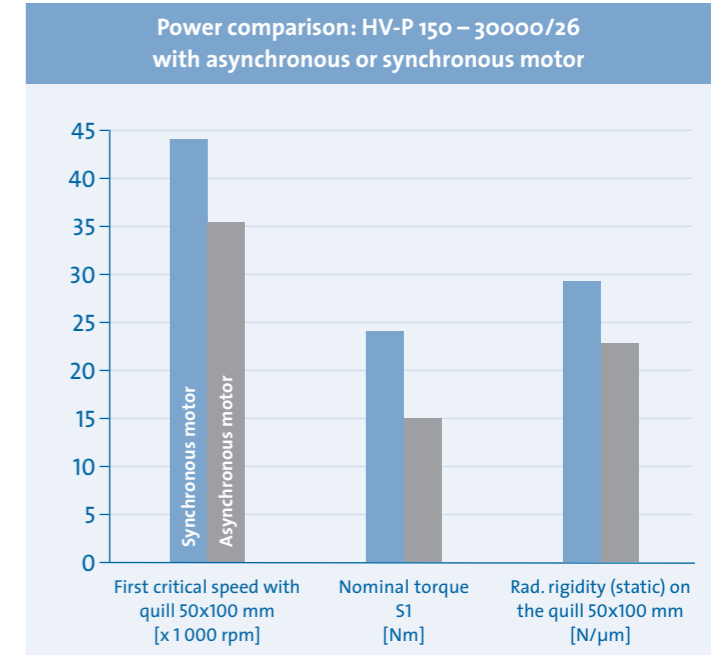

Power comparison: HV-P 150 – 30000/26 with asynchronous and synchronous motor				
Motor type		Asynchronous motor	Synchronous motor	Change
Radial rigidity (static)	Spindle nose [N/μm]	197.4	239.2	+21.2%
	on the mandrel 50 x 100 mm [N/μm]	23.1	29.1	+26.0%
Radial rigidity (30,000 rpm)	Spindle nose [N/μm]	129.4	151.6	+17.2%
	on the mandrel 50 x 100 mm [N/μm]	19.4	24.9	+28.4%
First critical speed with mandrel 50 x 100 mm	[rpm]	35,260	44,450	+26.1%
Nominal torque S1	[Nm]	15	24	+60.0%

Drive systems

Coolant supply through the spindle shaft

Drive without rotary encoder

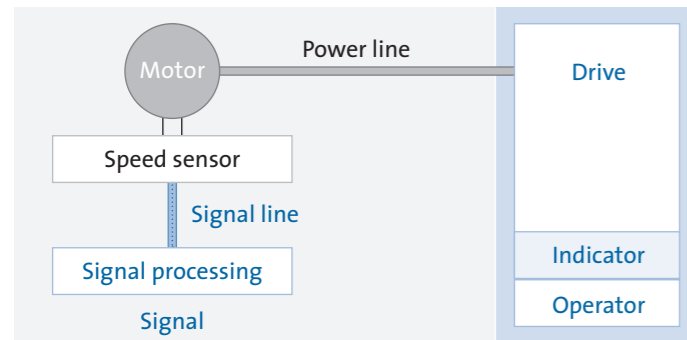

Drive without regulation: Frequency controller with prescribed voltage across the U/f characteristic

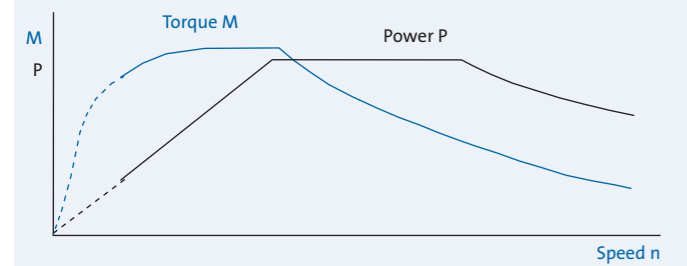

- Output frequency up to 3,000 Hz¹⁾
- Adjustment range to about 1 : 10
- Ramp up and brake time about 10 sec
- Shaft in a specified fixed position
- "Speed monitors" or "Tacho box" necessary
- "Sparking" and "Load limit" reports with "effective load tracker" option

Drive with regulation: Field oriented regulation

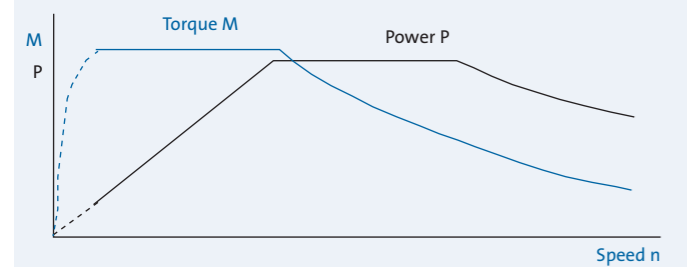

- Output frequency up to 1,400 Hz¹⁾
- Within adjustment range 1 : 10 speed stability about 0.5%
- Field oriented regulation algorithm
- Ramp up and brake time about 1 sec

Drive with rotary encoder (C-axis operation)

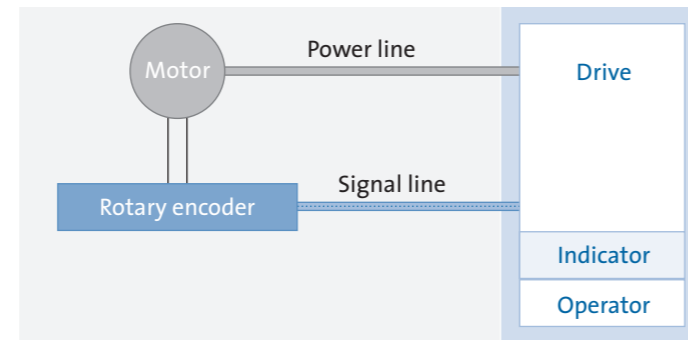

Field oriented regulation with rotary encoder, C-axis operation

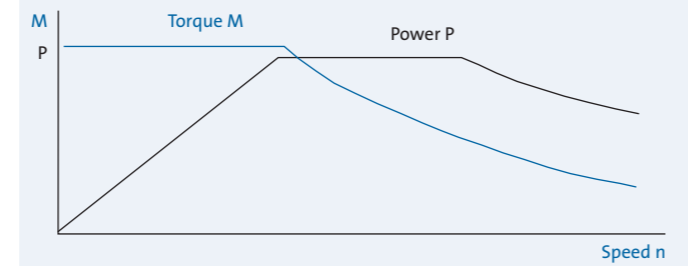

- Output frequency up to 1,400 Hz¹⁾
- Shaft positioning
- Ramp up and brake time about 1 sec

¹⁾ Various maximum output frequencies possible depending on manufacturer.

Equipping the spindle with a supplementary central coolant supply through the spindle's shaft is possible. This feature provides a substantial improvement in workpiece cooling when processing offset holes and blind holes.

- Cycle time reduction
- Improved surface quality
- Improved dimensional stability due to cooler finishing temperature
- Reduced risk of heat cracking for high performance grinding

In consideration for different processing requirements, GMN offers two different systems to supply coolant through the shaft:

Low pressure rotary union

Speed range up to: 120,000 rpm

- Seal: gap seal / air purge
- Maximum coolant pressure: 4 bar
- Dry run permissible
- Insensitive to pressure surges
- Necessary filter fineness: < 0.1 mm
- Installed spindle orientation: horizontal (other orientations on request)

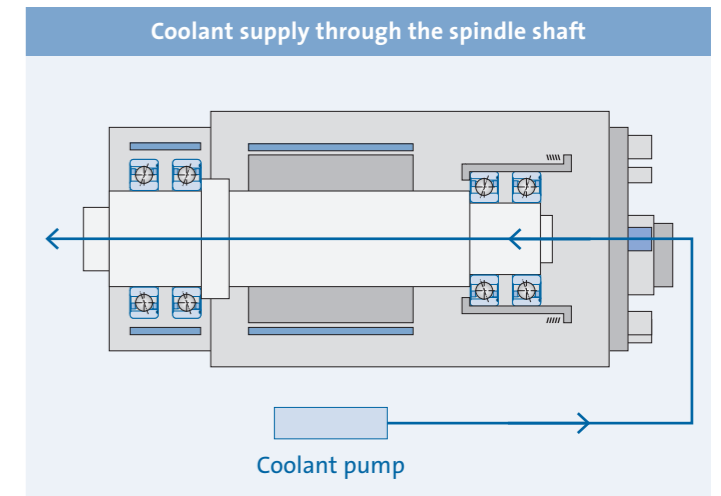

High pressure rotary union

Speed range up to: 75,000 rpm

- Seal: contact disc seal
- Maximum coolant pressure: dependent on spindle type, up to max. 50 bar (higher pressures on request)
- Minimum pressure 3 bar
- Dry run permissible
- Pressure surges must be avoided
- Necessary filter fineness: < 0.01 mm
- Installed spindle orientation: horizontal (other orientations on request)

Maximum speeds

GMN high-speed spindles are designed for processing procedures carried out at extremely high cutting speeds. Their performance profiles indicate the maximum speed values that can be achieved with consideration for the greatest possible running smoothness.



Imbalance spindle vibrations

Imbalanced mass distribution of rotating parts (spindle shaft, tool) with increasing speed induces sinusoidal imbalance vibrations which may be detrimental to machine operation and the quality of desired processing results.

Shaft

The highest processing quality in the production of GMN spindle shafts ensures a uniform mass distribution and minimum imbalance vibrations at maximum speeds.

Tool

Speed-intensive production processes demand particular attention to imbalance testing and may require the balancing of production-relevant tools in order to maintain vibration tolerances.

Long-term, comprehensive practical experience with precision milling has resulted in specific guidelines for maximum imbalance vibrations that still permit GMN spindles to provide optimal performance.

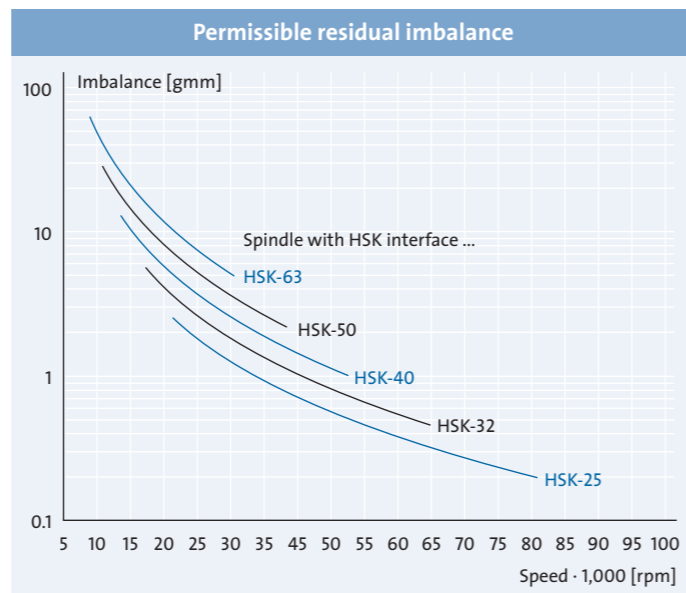

- Applicable for short tools.
- Even better balancing may be necessary for tools with a long overhang or where exceptionally high processing quality is required.
- Also applicable for spindles with grinding mandrel receiver (with comparable flat face diameter).

Spindle resonance vibrations

The resonance of rotating systems produces critical speed ranges in which extreme vibrations occur.

The use of tool attachments for machine operation can lower the critical speed range of the spindle/tool system and thus lead to a reduction of the maximum operating speed.

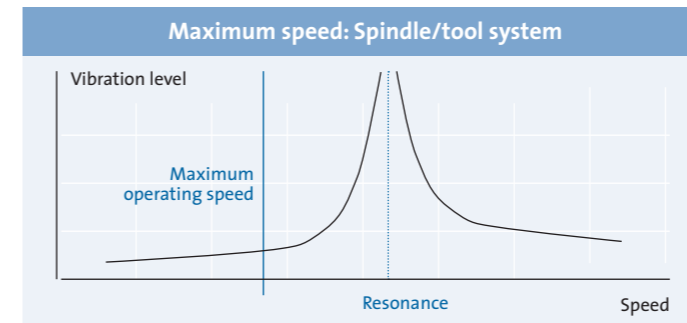
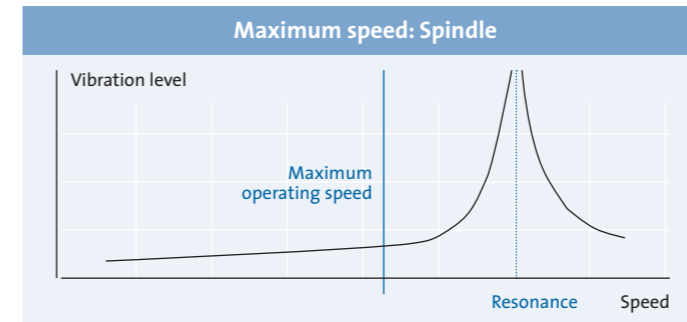

Vibration calculation

If tools with unusual dimensions or heavy weight are to be used, GMN offers to calculate the static and dynamic behavior of the envisioned spindle/tool system under operational conditions.

The proper analysis of calculation results delivers specific information about spindle selection and about tool optimization with consideration for load-dependent bending lines, rigidity, resonance and bearing loads.

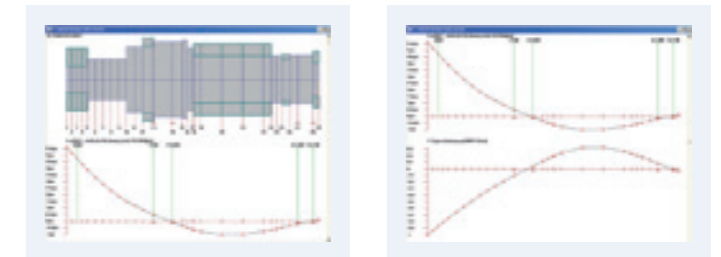

Vibration monitoring

Vibration monitoring devices detect the spindle's operational movements and initiate a fault shutdown if critical values are reached in order to maintain the system's mechanical safety. Detection of vibrations causing wear to the spindle's bearing indicates when additional preventative maintenance is necessary to ensure long machine service life.

The selection and layout of such devices should be done such that vibrations caused by other machine components are disregarded.

Tool interfaces

GMN standard: Internal taper with flat contact face

Because of the very high maximum speed ratings for type UHS, a GMN standard with internal taper/flat contact face and internal threads has been selected. This ensures a secure connection between shaft and tool over the entire speed range for the given spindle.



Internal taper with flat contact face

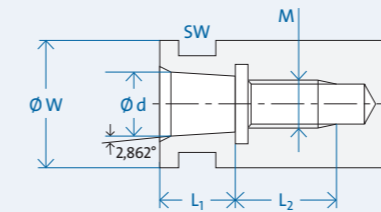

Series UHS (pages 24–25)

Interface	d [mm]	W [mm]	M	L ₁ [mm]	L ₂ [mm]	SW
U 07/10	7	10	M5	5	9	-
U 09/16	9	16	M8 (x 1.5)	7	16	14
U 12/18	12	18	M10 x 1.5	9	22	16
U 16/23	16	23	M14 x 1.25	12	22	20

GMN standard: Fitting bores with flat contact face

High-speed spindles in type series HS, HV-X and HSX are equipped with the GMN standard – fitting bore/flat contact face and internal threads – that has proven itself over many decades.

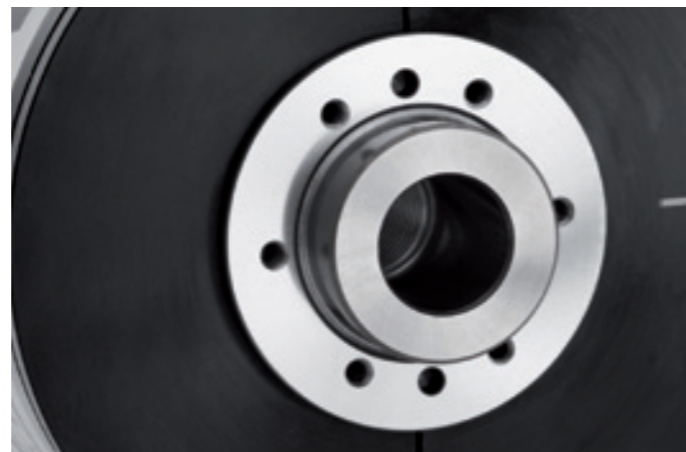

Fitting bore with flat contact face

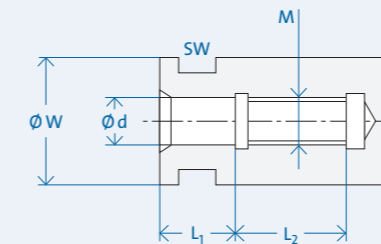

Series HS, HV-X, HSX (pages 26–41)

Interface	d [mm]	d Tolerance [μm]	W [mm]	M	L ₁ [mm]	L ₂ [mm]	SW
D 04/08	4	+ 5 / + 2	8	M4 (x 0.7)	6	8	7
D 06/12	6	+ 5 / + 2	12	M6 (x 1)	9	11	11
D 08/14	8	+ 5 / + 2	14	M8 (x 1.25)	12	14	13
D 09/16	9	+ 5 / + 2	16	M9 (x 1.25)	13	14	14
D 10/18	10	+ 5 / + 2	18	M10 (x 1.5)	15	19	16
D 14/23	14	+ 7 / + 2	23	M14 x 1.5	20	19	20
D 16/28	16	+ 7 / + 2	28	M16 x 1.5	24	19	24
D 22/38	22	+ 7 / + 2	38	M22 x 2	34	25	32
D 28/43	28	+ 8 / + 3	43	M28 x 2	42	25	38
D 32/53	32	+ 8 / + 3	53	M32 x 2	46	25	48
D 36/63	36	+ 8 / + 3	63	M36 x 2	50	30	55
D 36/68	36	+ 8 / + 3	68	M36 x 2	50	30	60

Taper hollow shaft with flat contact face: HSK-C

Taper hollow shafts (HSK) with flat contact faces are standardized per DIN 69893. The various shapes differ with respect to pusher dog recess and collar. Form C has been especially developed for use with manual tool change systems. Spindles in type series HV-P/HSP/HSP.g can accept tools with taper hollow shafts of form A and C. The HSK interface allows these spindles to be operated in both directions of rotation.

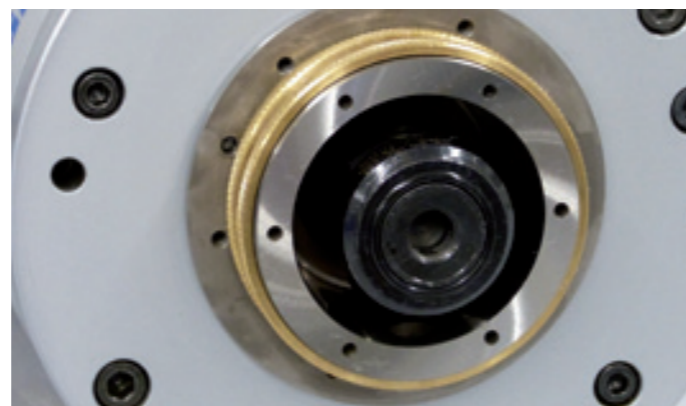

Taper hollow shaft with flat contact face

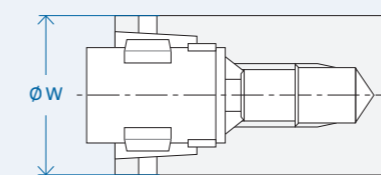

Series HV-P, HSP, HSP.. g (pages 42–69)

Interface	W [mm]	Dimensions
HSK-C25	25	remaining dimensions per DIN 69893-1
HSK-C32	32	
HSK-C40	40	
HSK-C50	50	
HSK-C63	63	
HSK-C80	80	
HSK-C100	100	

Legend and features

Legend

Dimensions:
 $\varnothing W$ = flat face \varnothing [mm]
 $\varnothing W_1$ = shaft \varnothing front [mm]
 $\varnothing A$ = spindle housing \varnothing [mm]

Rigidity (static):
 C_{ax} = axial rigidity [N/ μ m]
 C_{rad} = radial rigidity [N/ μ m]

Motor data:
 f = frequency max. [Hz]
 M = torque moment [Nm]
 n = speed [rpm]

Rated power:
 P = power [kW]
 I = current [A]

	GA	MAC/D500	B048/B049
Straight plug-in connection			
Angle plug-in connection			

Features	Standard	Option
Housing	Cylindrical housing Bushing- \varnothing : 80–230 mm	Cylindrical housing with flange housing Block housing
Motor	<i>Series: UHS</i> Motor voltage 200 V Synchronous motor Speed: max. 250,000 rpm Power: S1 max. 4.4 kW	
	<i>Series: HS</i> Motor voltage 200 V Asynchronous motor Speed: max. 180,000 rpm Power: S1 max. 0.95 kW	Synchronous motor ¹⁾
	<i>Series HV-X, HSX</i> Motor voltage 350 V Asynchronous motor Speed: max. 105,000 rpm Power: S1 max. 33 kW	Motor voltage 200 V / 460 V Synchronous motor ¹⁾
	<i>Series: HV-P, HSP</i> Motor voltage 350 V Asynchronous motor Speed: max. 60,000 rpm Power: S1 max. 45 kW	Motor voltage 200 V / 460 V Synchronous motor ¹⁾
Lubrication	Oil-air lubrication Permanent grease lubrication (HSP..g)	Air purge Permanent grease lubrication with air purge
Coolant supply through spindle shaft		Low pressure (du) (gap seal / air purge) High pressure (dh) (contact disc seal)
Sensor technology	Speed sensor beginning with housing \varnothing 100 mm	Rotary encoder only with HV-X and HV-P beginning with housing \varnothing 120 mm, remaining spindles on request

¹⁾ With the advantages from page 13

Technical data Features

GMN High speed spindles for manual tool change GMN standard tool interface

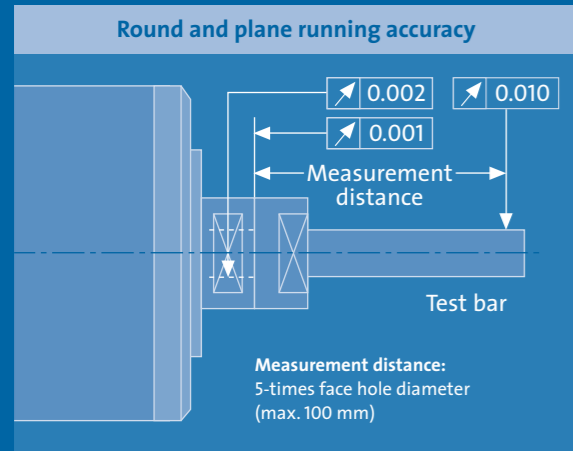

UHS

High-speed grinding spindles
Machining of small and very small bores
Delivery incl. frequency converter and lubricating device

- Housing \varnothing : 80 / 100 mm
- Speed: max. 250,000 rpm
- Power: S1 max. 4.4 kW
- Motor: Synchronous motor
- Tool interface: GMN standard
Internal taper with flat contact face
- Lubrication: Oil-air lubrication

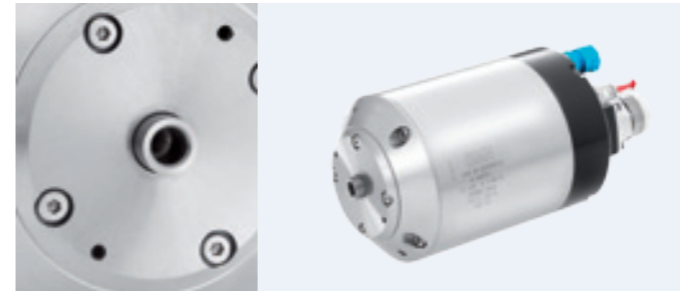

HV-X

High performance grinding spindles
Grinding applications
with high rigidity and power requirements

- Housing \varnothing : 100 / 120 / 150 mm
- Speed: max. 105,000 rpm
- Power: S1 max. 33 kW
- Motor: Asynchronous motor
- Tool interface: GMN standard
Fitting bore with flat contact face
- Lubrication: Oil-air lubrication



HS

High-speed grinding spindles
Machining of small bores

- Housing \varnothing : 80 mm
- Speed: max. 180,000 rpm
- Power: S1 max. 0.95 kW
- Motor: Asynchronous motor
- Tool interface: GMN standard
Fitting bore with flat contact face
- Lubrication: Oil-air lubrication

HSX

High performance grinding spindles
Universal grinding applications

- Housing \varnothing : 100 / 120 / 150 / 170 mm
- Speed: max. 105,000 rpm
- Power: S1 max. 32 kW
- Motor: Asynchronous motor
- Tool interface: GMN standard
Fitting bore with flat contact face
- Lubrication: Oil-air lubrication

Series: HS

Cylindrical housing:
Ø = 80 mm

Tool interface:
GMN standard

Motor:
Asynchronous motor

Bearing arrangement:
GMN high precision ball bearings

Lubrication:
Oil-air lubrication

TECHNICAL DATA	
Spindle housing Ø A	[mm]
Speed max. n _{max}	[rpm]
Bearing Ø front W ₁	[mm]
Tool interface	
Flat contact face Ø W	[mm]
Static rigidity	
axial C _{ax}	[N/µm]
radial C _{rad}	[N/µm]
Motor design	
Frequency max. f _{max}	[Hz]
Nominal converter voltage ¹⁾ [V]	
Power P _{s1}	[kW]
Torque M _{s1}	[Nm]
... at speed n	[rpm]
Current I _{s1}	[A]
Power P _{S6-60%}	[kW]
Torque M _{S6-60%}	[Nm]
... at speed n	[rpm]
Current I _{S6-60%}	[A]

Electrical connection	
Plug type	
Straight plug-in connection	
Angle plug-in connection	
Fixed cable XXm	
Coolant through the shaft	
Low pressure (du)	
High pressure (dh)	
Sensor technology	
Rotary encoder	
Speed sensor	
Housing	
Cylindrical housing	
Cylindrical housing with flange	
Block housing	
Air purge	

¹⁾ Minimum required output voltage of the frequency converter

- + Standard
- o Option
- x on request

HS 80 - 180000/0.4			
Spindle housing Ø A [mm]			
Speed max. n _{max} [rpm]			
Bearing Ø front W ₁ [mm]			
Tool interface			
Flat contact face Ø W [mm]			
Static rigidity			
axial C _{ax} [N/µm]			
radial C _{rad} [N/µm]			
Motor design			
Frequency max. f _{max} [Hz]			
Nominal converter voltage ¹⁾ [V]			
Power P _{s1} [kW]			
Torque M _{s1} [Nm]			
... at speed n [rpm]			
Current I _{s1} [A]			
Power P _{S6-60%} [kW]			
Torque M _{S6-60%} [Nm]			
... at speed n [rpm]			
Current I _{S6-60%} [A]			

Electrical connection			
Plug type			
Straight plug-in connection			
Angle plug-in connection			
Fixed cable XXm			
Coolant through the shaft			
Low pressure (du)			
High pressure (dh)			
Sensor technology			
Rotary encoder			
Speed sensor			
Housing			
Cylindrical housing			
Cylindrical housing with flange			
Block housing			
Air purge			

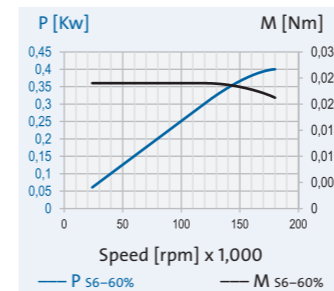

HS 80 - 150000/0.5			
Spindle housing Ø A [mm]			
Speed max. n _{max} [rpm]			
Bearing Ø front W ₁ [mm]			
Tool interface			
Flat contact face Ø W [mm]			
Static rigidity			
axial C _{ax} [N/µm]			
radial C _{rad} [N/µm]			
Motor design			
Frequency max. f _{max} [Hz]			
Nominal converter voltage ¹⁾ [V]			
Power P _{s1} [kW]			
Torque M _{s1} [Nm]			
... at speed n [rpm]			
Current I _{s1} [A]			
Power P _{S6-60%} [kW]			
Torque M _{S6-60%} [Nm]			
... at speed n [rpm]			
Current I _{S6-60%} [A]			

Electrical connection			
Plug type			
Straight plug-in connection			
Angle plug-in connection			
Fixed cable XXm			
Coolant through the shaft			
Low pressure (du)			
High pressure (dh)			
Sensor technology			
Rotary encoder			
Speed sensor			
Housing			
Cylindrical housing			
Cylindrical housing with flange			
Block housing			
Air purge			

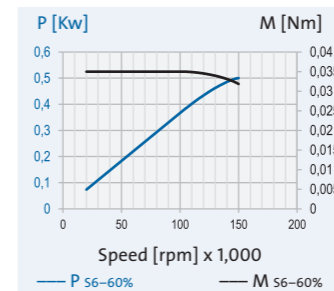

HS 80 - 120000/1.1			
Spindle housing Ø A [mm]			
Speed max. n _{max} [rpm]			
Bearing Ø front W ₁ [mm]			
Tool interface			
Flat contact face Ø W [mm]			
Static rigidity			
axial C _{ax} [N/µm]			
radial C _{rad} [N/µm]			
Motor design			
Frequency max. f _{max} [Hz]			
Nominal converter voltage ¹⁾ [V]			
Power P _{s1} [kW]			
Torque M _{s1} [Nm]			
... at speed n [rpm]			
Current I _{s1} [A]			
Power P _{S6-60%} [kW]			
Torque M _{S6-60%} [Nm]			
... at speed n [rpm]			
Current I _{S6-60%} [A]			

Electrical connection			
Plug type			
Straight plug-in connection			
Angle plug-in connection			
Fixed cable XXm			
Coolant through the shaft			
Low pressure (du)			
High pressure (dh)			
Sensor technology			
Rotary encoder			
Speed sensor			
Housing			
Cylindrical housing			
Cylindrical housing with flange			
Block housing			
Air purge			

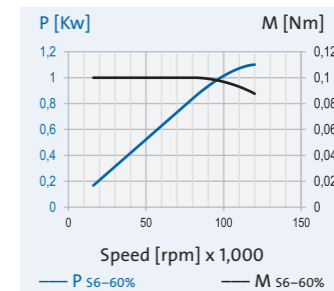

TECHNICAL DATA	
Spindle housing Ø A	[mm]
Speed max. n _{max}	[rpm]
Bearing Ø front W ₁	[mm]
Tool interface	
Flat contact face Ø W	[mm]
Static rigidity	
axial C _{ax}	[N/µm]
radial C _{rad}	[N/µm]
Motor design	
Frequency max. f _{max}	[Hz]
Nominal converter voltage ¹⁾ [V]	
Power P _{s1}	[kW]
Torque M _{s1}	[Nm]
... at speed n	[rpm]
Current I _{s1}	[A]
Power P _{S6-60%}	[kW]
Torque M _{S6-60%}	[Nm]
... at speed n	[rpm]
Current I _{S6-60%}	[A]

Electrical connection	
Plug type	
Straight plug-in connection	
Angle plug-in connection	
Fixed cable XXm	
Coolant through the shaft	
Low pressure (du)	
High pressure (dh)	
Sensor technology	
Rotary encoder	
Speed sensor	
Housing	
Cylindrical housing	
Cylindrical housing with flange	
Block housing	
Air purge	

¹⁾ Minimum required output voltage of the frequency converter

- + Standard
- o Option
- x on request

Series: HV-X

Cylindrical housing:
Ø = 100 mm

Tool interface:
GMN standard

Motor:
Asynchronous motor

Bearing arrangement:
GMN high precision
ball bearings

Lubrication:
Oil-air lubrication

TECHNICAL DATA	
Spindle housing Ø A	[mm]
Speed max.	n _{max} [rpm]
Bearing Ø front	W ₁ [mm]
Tool interface	
Flat contact face Ø W	[mm]
Static rigidity	
axial	C _{ax} [N/µm]
radial	C _{rad} [N/µm]
Motor design	
Frequency max.	f _{max} [Hz]
Nominal converter voltage ¹⁾	[V]
Power	P _{S1} [kW]
Torque	M _{S1} [Nm]
... at speed	n [rpm]
Current	I _{S1} [A]
Power	P _{S6-60%} [kW]
Torque	M _{S6-60%} [Nm]
... at speed	n [rpm]
Current	I _{S6-60%} [A]

Electrical connection	
Plug type	
Straight plug-in connection	
Angle plug-in connection	
Fixed cable XXm	
Coolant through the shaft	
Low pressure (du)	
High pressure (dh)	
Sensor technology	
Rotary encoder	
Speed sensor	
Housing	
Cylindrical housing	
Cylindrical housing with flange	
Block housing	
Air purge	

¹⁾ Minimum required output voltage of the frequency converter

- + Standard
- o Option
- x on request

HV-X 100 - 105000/2			
100			
105,000			
17			
D 09/16			
16			
33			
35			
200 V	350 V	460 V	
1,750			
200	350	460	
1.8			
0.16			
105,000			
9.6	5.5	4.2	
2			
0.18			
105,000			
11	6	4.6	

HV-X 100 - 105000/2			
GA	GA	GA	
+	+	+	
o	o	o	
o	o	o	
o			
o			
x			
-			
+			
+			
o			
x			
o			

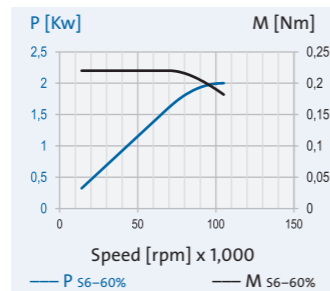

HV-X 100 - 90000/3			
100			
90,000			
20			
D 10/18			
18			
37			
40			
200 V	350 V	460 V	
1,500			
200	350	460	
2.5			
0.27			
90,000			
13	7.5	5.7	
3			
0.32			
90,000			
16	9	6.8	

HV-X 100 - 90000/3			
GA	GA	GA	
+	+	+	
o	o	o	
o	o	o	
o			
o			
x			
-			
+			
+			
o			
x			
o			

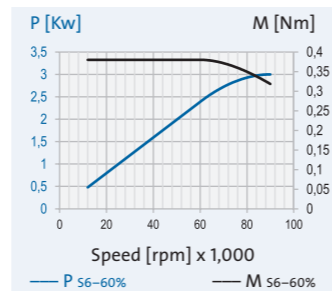

HV-X 100 - 75000/5			
100			
75,000			
25			
D 14/23			
23			
53			
56			
200 V	350 V	460 V	
1,250			
200	350	460	
4			
0.51			
75,000			
18	11	8	
5			
0.64			
75,000			
23	13	9.9	

HV-X 100 - 75000/5			
GA	GA	GA	
+	+	+	
o	o	o	
o	o	o	
o			
o			
x			
-			
+			
+			
o			
x			
o			

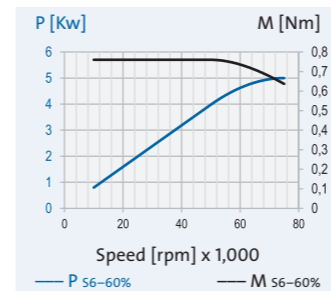

HV-X 100 - 60000/9			
100			
60,000			
30			
D 16/28			
28			
62			
73			
200 V	350 V	460 V	
2,000			
200	350	460	
7.5			
1.4			
51,000			
42	24	18	
9			
1.69			
51,000			
49	28	21	

HV-X 100 - 60000/9			
GA	GA	GA	
+	+	+	
o	o	o	
o	o	o	
o			
o			
x			
-			
+			
+			
o			
x			
o			

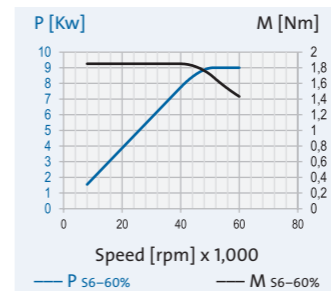

HV-X 100 - 45000/9			
100			
45,000			
40			
D 22/38			
38			
76			
85			
200 V	350 V	460 V	
1,500			
200	350	460	
7.5			
2.39			
30,000			
42	24	18	
9			
2.86			
30,000			
49	28	21	

HV-X 100 - 45000/9			
GA	GA	GA	
+	+	+	
o	o	o	
o	o	o	
o			
o			
x			
-			
+			
+			
o			
x			
o			

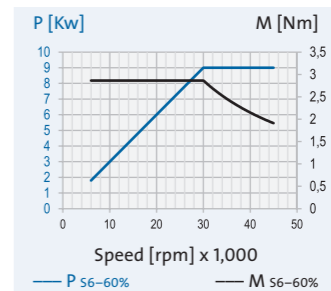

HV-X 100 - 30000/9			
100			
30,000			
45			
D 28/43			
43			
80			
74			
200 V	350 V	460 V	
1,000			
200	350	460	
7.5			
3.41			
21,000			
49	28	21	
9			
4.09			
21,000			
53	30	23	

HV-X 100 - 30000/9			
MAC	GA	GA	
+	+	+	
o	o	o	
o	o	o	
o			
o			
x			
-			
+			
+			
o			
x			
o			

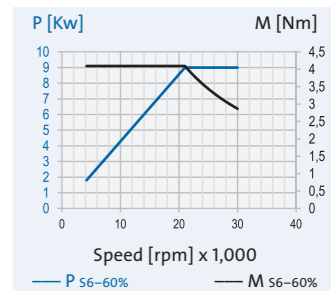

Series: HV-X

Cylindrical housing:
Ø = 150 mm

Tool interface:
GMN standard

Motor:
Asynchronous motor

Bearing arrangement:
GMN high precision ball bearings

Lubrication:
Oil-air lubrication

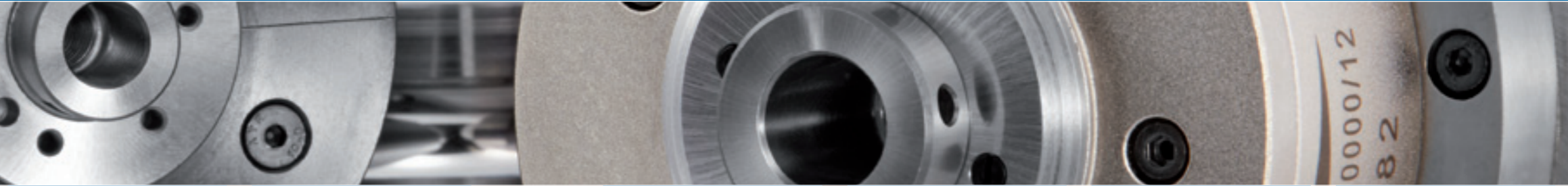

TECHNICAL DATA	
Spindle housing Ø A	[mm]
Speed max. n _{max}	[rpm]
Bearing Ø front W ₁	[mm]
Tool interface	
Flat contact face Ø W	[mm]
Static rigidity	
axial C _{ax}	[N/µm]
radial C _{rad}	[N/µm]
Motor design	
Frequency max. f _{max}	[Hz]
Nominal converter voltage ¹⁾	[V]
Power P _{S1}	[kW]
Torque M _{S1}	[Nm]
... at speed n	[rpm]
Current I _{S1}	[A]
Power P _{S6-60%}	[kW]
Torque M _{S6-60%}	[Nm]
... at speed n	[rpm]
Current I _{S6-60%}	[A]

HV-X 150 - 45000/36			
150			
45,000			
45			
D 28/43			
43			
91			
150			
200 V	350 V	460 V	
1,500			
200	350	460	
32			
10.2			
30,000			
152	87	66	
36			
11.5			
30,000			
166	95	72	

HV-X 150 - 45000/25			
150			
45,000			
45			
D 28/43			
43			
91			
150			
200 V	350 V	460 V	
1,500			
200	350	460	
22			
10			
21,000			
105	60	46	
25			
11.4			
21,000			
117	67	51	

HV-X 150 - 30000/37			
150			
30,000			
65			
D 36/63			
63			
121			
197			
200 V	350 V	460 V	
1,000			
200	350	460	
33			
15			
21,000			
147	84	64	
37			
16.8			
21,000			
161	92	70	

HV-X 150 - 30000/26			
150			
30,000			
65			
D 36/63			
63			
121			
197			
200 V	350 V	460 V	
1,000			
200	350	460	
23			
14.6			
15,000			
105	60	46	
26			
16.6			
15,000			
117	67	51	

TECHNICAL DATA	
Spindle housing Ø A	[mm]
Speed max. n _{max}	[rpm]
Bearing Ø front W ₁	[mm]
Tool interface	
Flat contact face Ø W	[mm]
Static rigidity	
axial C _{ax}	[N/µm]
radial C _{rad}	[N/µm]
Motor design	
Frequency max. f _{max}	[Hz]
Nominal converter voltage ¹⁾	[V]
Power P _{S1}	[kW]
Torque M _{S1}	[Nm]
... at speed n	[rpm]
Current I _{S1}	[A]
Power P _{S6-60%}	[kW]
Torque M _{S6-60%}	[Nm]
... at speed n	[rpm]
Current I _{S6-60%}	[A]

Electrical connection	
Plug type	
Straight plug-in connection	
Angle plug-in connection	
Fixed cable XXm	
Coolant through the shaft	
Low pressure (du)	
High pressure (dh)	
Sensor technology	
Rotary encoder	
Speed sensor	
Housing	
Cylindrical housing	
Cylindrical housing with flange	
Block housing	
Air purge	

HV-X 150 - 45000/36			
D500	D500	MAC	
+	+	+	
o	o	o	
o	o	o	
x			
o			
o			
+			
+			
o			
x			
o			

HV-X 150 - 45000/25			
D500	MAC	MAC	
+	+	+	
o	o	o	
o	o	o	
x			
o			
o			
+			
+			
o			
x			
o			

HV-X 150 - 30000/37			
D500	D500	MAC	
+	+	+	
o	o	o	
o	o	o	
x			
o			
o			
+			
+			
o			
x			
o			

HV-X 150 - 30000/26			
D500	MAC	MAC	
+	+	+	
o	o	o	
o	o	o	
x			
o			
o			
+			
+			
o			
x			
o			

Electrical connection	
Plug type	
Straight plug-in connection	
Angle plug-in connection	
Fixed cable XXm	
Coolant through the shaft	
Low pressure (du)	
High pressure (dh)	
Sensor technology	
Rotary encoder	
Speed sensor	
Housing	
Cylindrical housing	
Cylindrical housing with flange	
Block housing	
Air purge	

¹⁾ Minimum required output voltage of the frequency converter

- + Standard
- o Option
- x on request

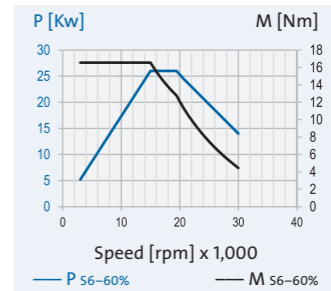
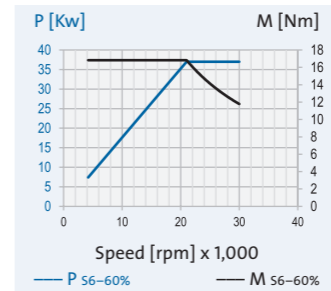
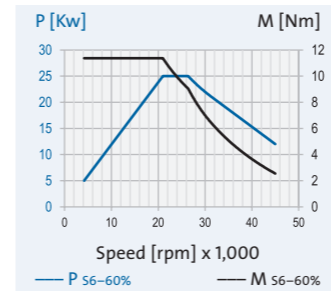
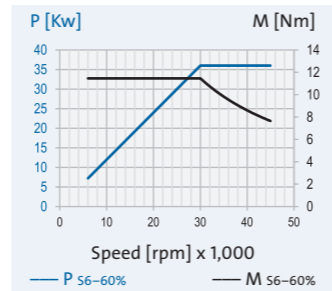

¹⁾ Minimum required output voltage of the frequency converter

- + Standard
- o Option
- x on request

Series: HSX

Cylindrical housing:
Ø = 100 mm

Tool interface:
GMN standard

Motor:
Asynchronous motor

Bearing arrangement:
GMN high precision ball bearings

Lubrication:
Oil-air lubrication

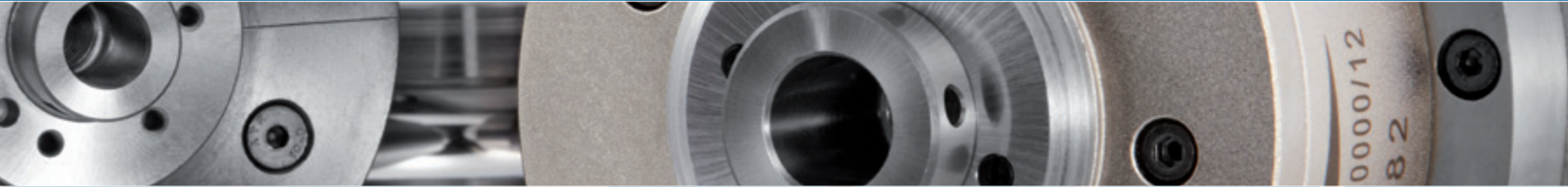

TECHNICAL DATA	
Spindle housing Ø A [mm]	100
Speed max. n _{max} [rpm]	105,000
Bearing Ø front W ₁ [mm]	15
Tool interface	D 08/14
Flat contact face Ø W [mm]	14
Static rigidity	
axial C _{ax} [N/µm]	26
radial C _{rad} [N/µm]	29
Motor design	
Frequency max. f _{max} [Hz]	1,750
Nominal converter voltage ¹⁾ [V]	200
Power P _{S1} [kW]	1.7
Torque M _{S1} [Nm]	0.16
... at speed n [rpm]	105,000
Current I _{S1} [A]	8,8
Power P _{S6-60%} [kW]	2
Torque M _{S6-60%} [Nm]	0.18
... at speed n [rpm]	105,000
Current I _{S6-60%} [A]	11

Electrical connection	
Plug type	GA
Straight plug-in connection	+
Angle plug-in connection	o
Fixed cable XXm	o
Coolant through the shaft	
Low pressure (du)	o
High pressure (dh)	-
Sensor technology	
Rotary encoder	-
Speed sensor	+
Housing	
Cylindrical housing	+
Cylindrical housing with flange	o
Block housing	x
Air purge	o

¹⁾ Minimum required output voltage of the frequency converter

- + Standard
- o Option
- x on request

HSX 100 - 105000/2			
200 V			
350 V			
-			
200	350	-	
11			

GA	GA	-	
+	+	-	
o	o	-	
o	o	-	
o			
o			
-			
-			
-			
+			
+			
o			
o			
x			
o			

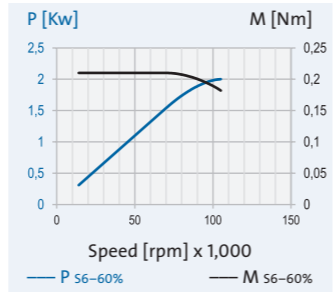

HSX 100 - 90000/3			
200 V			
350 V			
-			
200	350	-	
16			

GA	GA	-	
+	+	-	
o	o	-	
o	o	-	
o			
o			
-			
-			
-			
+			
+			
o			
o			
x			
o			

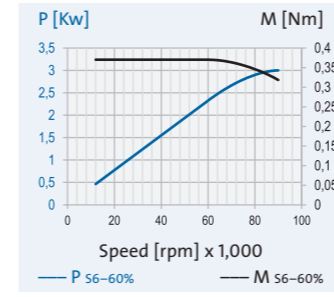

HSX 100 - 75000/5			
200 V			
350 V			
-			
200	350	-	
23			

GA	GA	-	
+	+	-	
o	o	-	
o	o	-	
o			
o			
-			
-			
-			
+			
+			
o			
o			
x			
o			

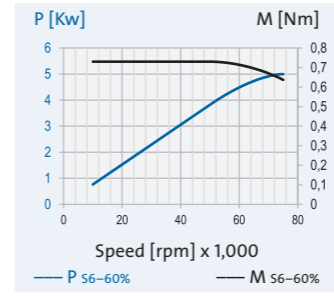

HSX 100 - 60000/5			
200 V			
350 V			
-			
200	350	-	
23			

GA	GA	-	
+	+	-	
o	o	-	
o	o	-	
o			
o			
-			
-			
-			
+			
+			
o			
o			
x			
o			

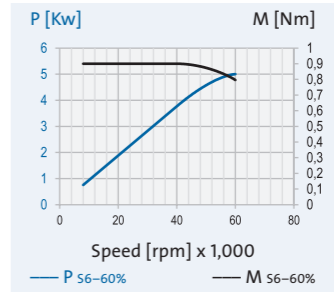

TECHNICAL DATA	
Spindle housing Ø A [mm]	100
Speed max. n _{max} [rpm]	60,000
Bearing Ø front W ₁ [mm]	25
Tool interface	D 14/23
Flat contact face Ø W [mm]	23
Static rigidity	
axial C _{ax} [N/µm]	53
radial C _{rad} [N/µm]	53
Motor design	
Frequency max. f _{max} [Hz]	1,000
Nominal converter voltage ¹⁾ [V]	200
Power P _{S1} [kW]	4.2
Torque M _{S1} [Nm]	0.67
... at speed n [rpm]	60,000
Current I _{S1} [A]	18
Power P _{S6-60%} [kW]	5
Torque M _{S6-60%} [Nm]	0.8
... at speed n [rpm]	60,000
Current I _{S6-60%} [A]	23

Electrical connection	
Plug type	GA
Straight plug-in connection	+
Angle plug-in connection	o
Fixed cable XXm	o
Coolant through the shaft	
Low pressure (du)	o
High pressure (dh)	-
Sensor technology	
Rotary encoder	-
Speed sensor	+
Housing	
Cylindrical housing	+
Cylindrical housing with flange	o
Block housing	x
Air purge	o

¹⁾ Minimum required output voltage of the frequency converter

- + Standard
- o Option
- x on request

Series: HSX

Cylindrical housing:
Ø = 120 mm

Tool interface:
GMN standard

Motor:
Asynchronous motor

Bearing arrangement:
GMN high precision ball bearings

Lubrication:
Oil-air lubrication

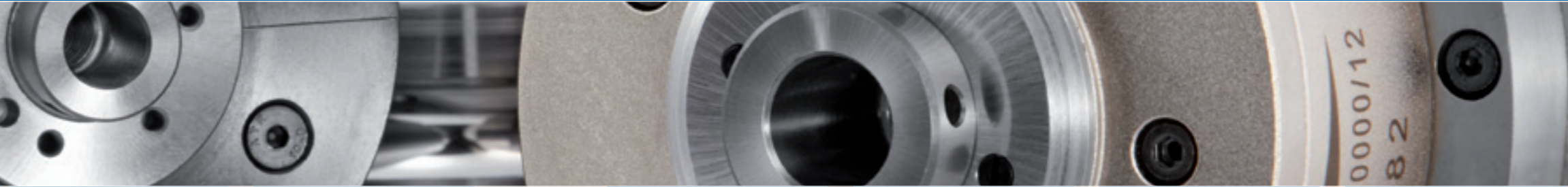

TECHNICAL DATA	
Spindle housing Ø A [mm]	120
Speed max. n _{max} [rpm]	60,000
Bearing Ø front W ₁ [mm]	25
Tool interface	D 14/23
Flat contact face Ø W [mm]	23
Static rigidity	
axial C _{ax} [N/µm]	54
radial C _{rad} [N/µm]	57
Motor design	
Frequency max. f _{max} [Hz]	1,000
Nominal converter voltage ¹⁾ [V]	200 350 460
Power P _{S1} [kW]	6
Torque M _{S1} [Nm]	0.96
... at speed n [rpm]	60,000
Current I _{S1} [A]	28 16 12
Power P _{S6-60%} [kW]	7
Torque M _{S6-60%} [Nm]	1.11
... at speed n [rpm]	60,000
Current I _{S6-60%} [A]	32 18 14

Electrical connection	
Plug type	GA GA GA
Straight plug-in connection	+ + +
Angle plug-in connection	o o o
Fixed cable XXm	o o o
Coolant through the shaft	
Low pressure (du)	o
High pressure (dh)	x
Sensor technology	
Rotary encoder	x
Speed sensor	+
Housing	
Cylindrical housing	+
Cylindrical housing with flange	o
Block housing	x
Air purge	o

¹⁾ Minimum required output voltage of the frequency converter

- + Standard
- o Option
- x on request

HSX 120 - 60000/7			
120			
60,000			
25			
D 14/23			
23			
54			
57			
200 V	350 V	460 V	
1,000			
200	350	460	
6			
0.96			
60,000			
28	16	12	
7			
1.11			
60,000			
32	18	14	

Electrical connection			
GA	GA	GA	
+	+	+	
o	o	o	
o	o	o	
o			
o			
x			
x			
+			
+			
o			
x			
o			

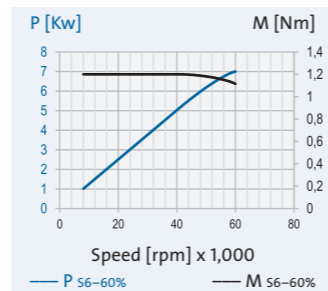

HSX 120 - 51000/12			
120			
51,000			
30			
D 16/28			
28			
70			
102			
200 V	350 V	460 V	
1,700			
200	350	460	
11			
3.5			
30,000			
63	36	27	
12			
3.82			
30,000			
67	38	29	

Electrical connection			
MAC	GA	GA	
+	+	+	
o	o	o	
o	o	o	
o			
o			
x			
x			
+			
+			
o			
x			
o			

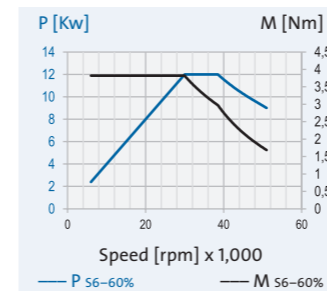

HSX 120 - 42000/12			
120			
42,000			
40			
D 22/38			
38			
90			
121			
200 V	350 V	460 V	
1,400			
200	350	460	
11			
3.5			
30,000			
63	36	27	
12			
3.82			
30,000			
67	38	29	

Electrical connection			
MAC	GA	GA	
+	+	+	
o	o	o	
o	o	o	
o			
o			
x			
x			
+			
+			
o			
x			
o			

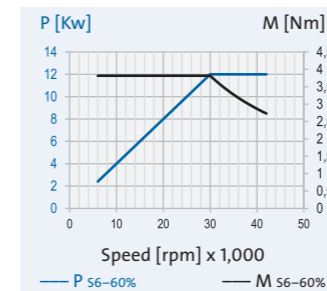

HSX 120 - 30000/13			
120			
30,000			
45			
D 28/43			
43			
98			
131			
200 V	350 V	460 V	
1,500			
200	350	460	
11			
5.84			
18,000			
72	41	31	
13			
6.9			
18,000			
84	48	37	

Electrical connection			
MAC	GA	GA	
+	+	+	
o	o	o	
o	o	o	
o			
o			
x			
x			
+			
+			
o			
x			
o			

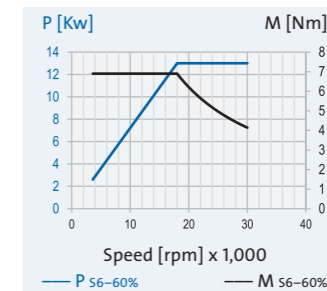

TECHNICAL DATA	
Spindle housing Ø A [mm]	120
Speed max. n _{max} [rpm]	30,000
Bearing Ø front W ₁ [mm]	45
Tool interface	D 28/43
Flat contact face Ø W [mm]	43
Static rigidity	
axial C _{ax} [N/µm]	98
radial C _{rad} [N/µm]	131
Motor design	
Frequency max. f _{max} [Hz]	1,500
Nominal converter voltage ¹⁾ [V]	200 350 460
Power P _{S1} [kW]	11
Torque M _{S1} [Nm]	5.84
... at speed n [rpm]	18,000
Current I _{S1} [A]	72 41 31
Power P _{S6-60%} [kW]	13
Torque M _{S6-60%} [Nm]	6.9
... at speed n [rpm]	18,000
Current I _{S6-60%} [A]	84 48 37

Electrical connection	
Plug type	MAC GA GA
Straight plug-in connection	+ + +
Angle plug-in connection	o o o
Fixed cable XXm	o o o
Coolant through the shaft	
Low pressure (du)	o
High pressure (dh)	x
Sensor technology	
Rotary encoder	x
Speed sensor	+
Housing	
Cylindrical housing	+
Cylindrical housing with flange	o
Block housing	x
Air purge	o

¹⁾ Minimum required output voltage of the frequency converter

- + Standard
- o Option
- x on request

Series: HSX

Cylindrical housing:
Ø = 150 mm

Tool interface:
GMN standard

Motor:
Asynchronous motor

Bearing arrangement:
GMN high precision
ball bearings

Lubrication:
Oil-air lubrication

TECHNICAL DATA		HSX 150 - 42000/16			HSX 150 - 42000/11			HSX 150 - 30000/23			HSX 150 - 30000/16			HSX 150 - 24000/23			HSX 150 - 24000/17		
Spindle housing Ø A	[mm]	150			150			150			150			150			150		
Speed max.	n _{max} [rpm]	42,000			42,000			30,000			30,000			24,000			24,000		
Bearing Ø front	W ₁ [mm]	40			40			55			55			65			65		
Tool interface		D 22/38			D 22/38			D 32/53			D 32/53			D 36/63			D 36/63		
Flat contact face Ø W	[mm]	38			38			53			53			63			63		
Static rigidity																			
axial	C _{ax} [N/µm]	90			90			111			111			130			130		
radial	C _{rad} [N/µm]	147			147			177			177			147			147		
Motor design		200 V	350 V	460 V	200 V	350 V	460 V	200 V	350 V	460 V	200 V	350 V	460 V	200 V	350 V	460 V	200 V	350 V	460 V
Frequency max.	f _{max} [Hz]	1,400			1,400			1,000			1,000			800			800		
Nominal converter voltage ¹⁾	[V]	200	350	460	200	350	460	200	350	460	200	350	460	200	350	460	200	350	460
Power	P _{S1} [kW]	14			9.5			18			14			18			14		
Torque	M _{S1} [Nm]	4.95			5.04			9.55			9.9			9.55			12.2		
... at speed	n [rpm]	27,000			18,000			18,000			13,500			18,000			11,000		
Current	I _{S1} [A]	86	49	37	47	27	21	86	49	37	63	36	27	86	49	37	65	37	28
Power	P _{S6-60%} [kW]	16			11			23			16			23			17		
Torque	M _{S6-60%} [Nm]	5.66			5.84			12.2			11.3			12.2			14.8		
... at speed	n [rpm]	27,000			18,000			18,000			13,500			18,000			11,000		
Current	I _{S6-60%} [A]	102	58	44	54	31	24	110	63	48	70	40	30	110	63	48	79	45	34

Electrical connection	HSX 150 - 42000/16			HSX 150 - 42000/11			HSX 150 - 30000/23			HSX 150 - 30000/16			HSX 150 - 24000/23			HSX 150 - 24000/17			
Plug type	MAC	MAC	GA	MAC	GA	GA	MAC	MAC	GA	MAC	GA	GA	MAC	MAC	GA	MAC	GA	GA	
Straight plug-in connection	+	+	+	+	+	+	+	+	+	+	+	+	+	+	+	+	+	+	
Angle plug-in connection	o	o	o	o	o	o	o	o	o	o	o	o	o	o	o	o	o	o	
Fixed cable XXm	o	o	o	o	o	o	o	o	o	o	o	o	o	o	o	o	o	o	
Coolant through the shaft																			
Low pressure (du)	o			o			x			x			-			-			
High pressure (dh)	x			x			x			x			x			x			
Sensor technology																			
Rotary encoder	x			x			x			x			x			x			
Speed sensor	+			+			+			+			+			+			
Housing																			
Cylindrical housing	+			+			+			+			+			+			
Cylindrical housing with flange	o			o			o			o			o			o			
Block housing	x			x			x			x			x			x			
Air purge	o			o			o			o			o			o			

¹⁾ Minimum required output voltage of the frequency converter

- + Standard
- o Option
- x on request

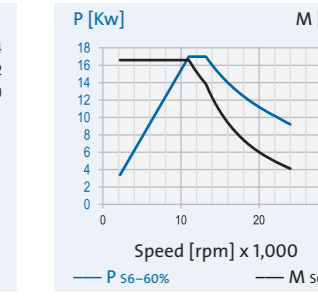
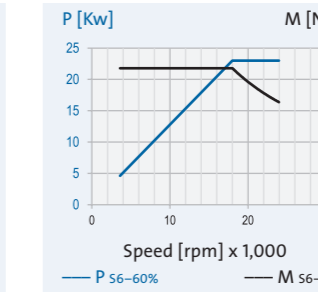
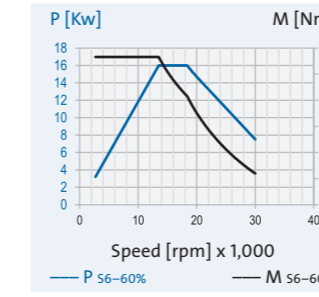
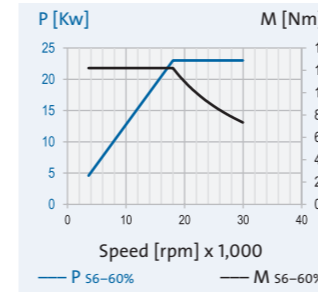
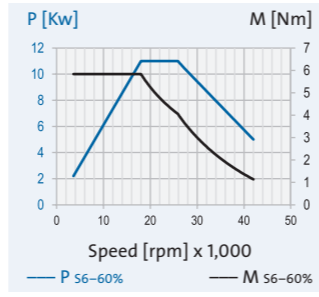
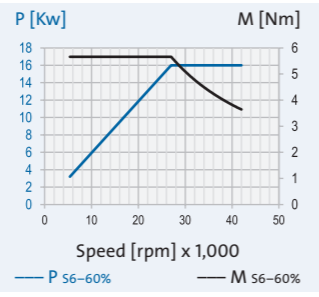

Series: HSX

Cylindrical housing:
Ø = 170 mm

Tool interface:
GMN standard

Motor:
Asynchronous motor

Bearing arrangement:
GMN high precision
ball bearings

Lubrication:
Oil-air lubrication

TECHNICAL DATA	
Spindle housing Ø A	[mm]
Speed max. n_{max}	[rpm]
Bearing Ø front W_1	[mm]
Tool interface	
Flat contact face Ø W	[mm]
Static rigidity	
axial C_{ax}	[N/µm]
radial C_{rad}	[N/µm]
Motor design	
Frequency max. f_{max}	[Hz]
Nominal converter voltage ¹⁾	[V]
Power P_{S1}	[kW]
Torque M_{S1}	[Nm]
... at speed n	[rpm]
Current I_{S1}	[A]
Power $P_{S6-60\%}$	[kW]
Torque $M_{S6-60\%}$	[Nm]
... at speed n	[rpm]
Current $I_{S6-60\%}$	[A]

Electrical connection	
Plug type	
Straight plug-in connection	
Angle plug-in connection	
Fixed cable XXm	
Coolant through the shaft	
Low pressure (du)	
High pressure (dh)	
Sensor technology	
Rotary encoder	
Speed sensor	
Housing	
Cylindrical housing	
Cylindrical housing with flange	
Block housing	
Air purge	

¹⁾ Minimum required output voltage of the frequency converter

+ Standard
o Option
x on request

HSX 170 - 30000/35			
170			
30,000			
55			
D 32/53			
53			
111			
203			
200 V	350 V	460 V	
1,000			
200	350	460	
32			
20.4			
15,000			
140	80	61	
35			
22.3			
15,000			
151	86	65	

HSX 170 - 30000/21			
170			
30,000			
55			
D 32/53			
53			
111			
203			
200 V	350 V	460 V	
1,000			
200	350	460	
19			
20.2			
9,000			
82	47	36	
21			
22.3			
9,000			
93	53	40	

HSX 170 - 24000/35			
170			
24,000			
65			
D 36/63			
63			
130			
231			
200 V	350 V	460 V	
800			
200	350	460	
32			
20.4			
15,000			
140	80	61	
35			
22.3			
15,000			
151	86	65	

HSX 170 - 24000/21			
170			
24,000			
65			
D 36/63			
63			
130			
231			
200 V	350 V	460 V	
800			
200	350	460	
19			
20.2			
9,000			
82	47	36	
21			
22.3			
9,000			
93	53	40	

HSX 170 - 18000/34			
170			
18,000			
70			
D 36/68			
68			
201			
325			
200 V	350 V	460 V	
600			
200	350	460	
29			
25.2			
11,000			
117	67	51	
34			
29.5			
11,000			
137	78	59	

HSX 170 - 18000/23			
170			
18,000			
70			
D 36/68			
68			
201			
325			
200 V	350 V	460 V	
600			
200	350	460	
20			
25.5			
7,500			
89	51	39	
23			
29.3			
7,500			
102	58	44	

D500		
+	+	+
o	o	o
o	o	o
-		
x		
-		
x		
+		
-		
+		
o		
x		
o		

MAC		
+	+	+
o	o	o
o	o	o
-		
x		
-		
x		
+		
-		
+		
o		
x		
o		

D500		
+	+	+
o	o	o
o	o	o
-		
x		
-		
x		
+		
-		
+		
o		
x		
o		

MAC		
+	+	+
o	o	o
o	o	o
-		
x		
-		
x		
+		
-		
+		
o		
x		
o		

D500		
+	+	+
o	o	o
o	o	o
-		
x		
-		
x		
+		
-		
+		
o		
x		
o		

D500		
+	+	+
o	o	o
o	o	o
-		
x		
-		
x		
+		
-		
+		
o		
x		
o		

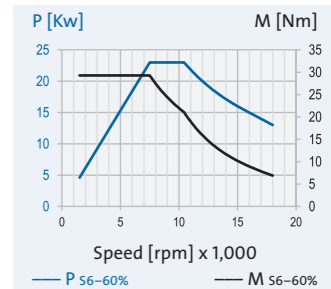
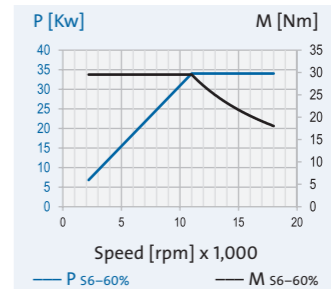
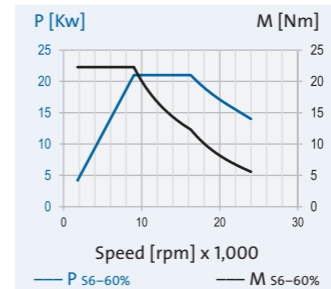
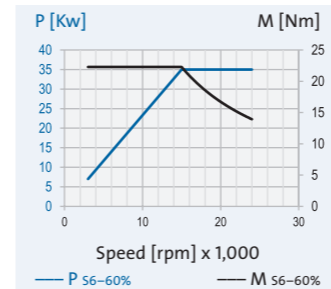
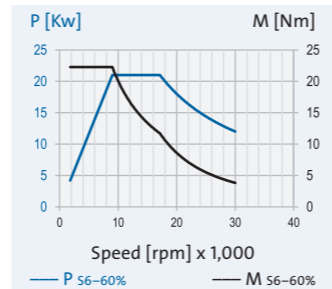
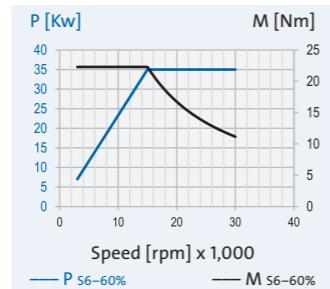

Technical data Features

GMN High speed spindles for manual tool change HSK interface

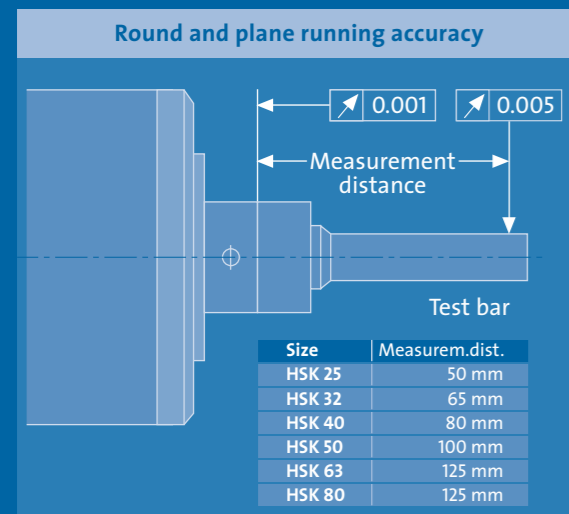

HV-P

High-performance all-round spindles
Grinding, milling and drilling applications
with high rigidity and performance requirements

- Housing Ø: 100 / 120 / 150 mm
- Speed: max. 60,000 rpm
- Power: S1 max. 33 kW
- Motor: Asynchronous motor
- Tool interface: HSK-C
- Lubrication: Oil-air lubrication

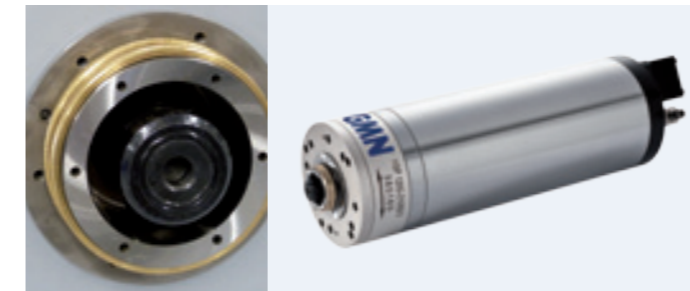

HSP

High-performance all-round spindles
Universal grinding, milling and drilling applications

- Housing Ø: 100 / 120 / 150 / 170 / 230 mm
- Speed: max. 51,000 rpm
- Power: S1 max. 45 kW
- Motor: Asynchronous motor
- Tool interface: HSK-C
- Lubrication: Oil-air lubrication

HSP..g

High-performance all-round spindles
Universal grinding, milling and drilling applications

- Housing Ø: 100 / 120 / 150 / 170 / 230 mm
- Speed: max. 30,000 rpm
- Power: S1 max. 45 kW
- Motor: Asynchronous motor
- Tool interface: HSK-C
- Lubrication: Permanent grease lubrication

Series: HV-P

Cylindrical housing:
Ø = 100 mm

Tool interface:
HSK-C

Motor:
Asynchronous motor

Bearing arrangement:
GMN high precision ball bearings

Lubrication:
Oil-air lubrication

TECHNICAL DATA	
Spindle housing Ø A	[mm]
Speed max. n_{max}	[rpm]
Bearing Ø front W_1	[mm]
Tool interface	
Flat contact face Ø W	[mm]
Static rigidity	
axial C_{ax}	[N/µm]
radial C_{rad}	[N/µm]
Motor design	
Frequency max. f_{max}	[Hz]
Nominal converter voltage ¹⁾	[V]
Power P_{S1}	[kW]
Torque M_{S1}	[Nm]
... at speed n	[rpm]
Current I_{S1}	[A]
Power $P_{S6-60\%}$	[kW]
Torque $M_{S6-60\%}$	[Nm]
... at speed n	[rpm]
Current $I_{S6-60\%}$	[A]

Electrical connection	
Plug type	
Straight plug-in connection	
Angle plug-in connection	
Fixed cable XXm	
Coolant through the shaft	
Low pressure (du)	
High pressure (dh)	
Sensor technology	
Rotary encoder	
Speed sensor	
Housing	
Cylindrical housing	
Cylindrical housing with flange	
Block housing	
Air purge	

¹⁾ Minimum required output voltage of the frequency converter

- + Standard
- o Option
- x on request

HV-P 100 - 60000/9			
100			
60,000			
30			
HSK-C 25			
25			
62			
73			
200 V	350 V	460 V	
2,000			
200	350	460	
7.5			
1.4			
51,000			
42	24	18	
9			
1.69			
51,000			
49	28	21	

Electrical connection			
GA	GA	GA	
+	+	+	
o	o	o	
o	o	o	
Coolant through the shaft			
-			
x			
-			
+			
+			
o			
x			
o			

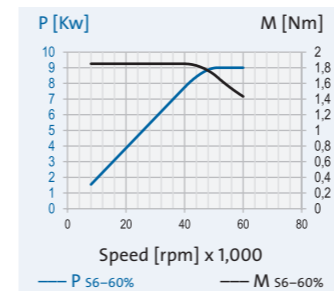

HV-P 100 - 45000/9			
100			
45,000			
40			
HSK-C 32			
32			
76			
85			
200 V	350 V	460 V	
1,500			
200	350	460	
7.5			
2.39			
30,000			
42	24	18	
9			
2.86			
30,000			
49	28	21	

Electrical connection			
GA	GA	GA	
+	+	+	
o	o	o	
o	o	o	
Coolant through the shaft			
-			
x			
-			
+			
+			
o			
x			
o			

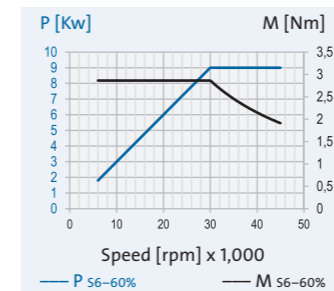

HV-P 100 - 30000/9			
100			
30,000			
45			
HSK-C 40			
40			
80			
74			
200 V	350 V	460 V	
1,000			
200	350	460	
7.5			
3.41			
21,000			
49	28	21	
9			
4.09			
21,000			
53	30	23	

Electrical connection			
MAC	GA	GA	
+	+	+	
x	x	x	
o	o	o	
Coolant through the shaft			
-			
x			
-			
+			
+			
o			
x			
o			

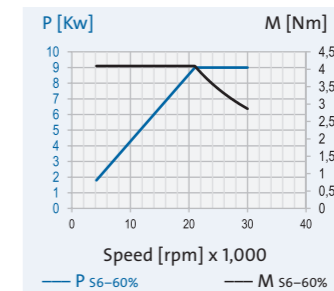

TECHNICAL DATA	
Spindle housing Ø A	[mm]
Speed max. n_{max}	[rpm]
Bearing Ø front W_1	[mm]
Tool interface	
Flat contact face Ø W	[mm]
Static rigidity	
axial C_{ax}	[N/µm]
radial C_{rad}	[N/µm]
Motor design	
Frequency max. f_{max}	[Hz]
Nominal converter voltage ¹⁾	[V]
Power P_{S1}	[kW]
Torque M_{S1}	[Nm]
... at speed n	[rpm]
Current I_{S1}	[A]
Power $P_{S6-60\%}$	[kW]
Torque $M_{S6-60\%}$	[Nm]
... at speed n	[rpm]
Current $I_{S6-60\%}$	[A]

Electrical connection	
Plug type	
Straight plug-in connection	
Angle plug-in connection	
Fixed cable XXm	
Coolant through the shaft	
Low pressure (du)	
High pressure (dh)	
Sensor technology	
Rotary encoder	
Speed sensor	
Housing	
Cylindrical housing	
Cylindrical housing with flange	
Block housing	
Air purge	

¹⁾ Minimum required output voltage of the frequency converter

- + Standard
- o Option
- x on request

Series: HV-P

Cylindrical housing:
Ø = 120 mm

Tool interface:
HSK-C

Motor:
Asynchronous motor

Bearing arrangement:
GMN high precision ball bearings

Lubrication:
Oil-air lubrication

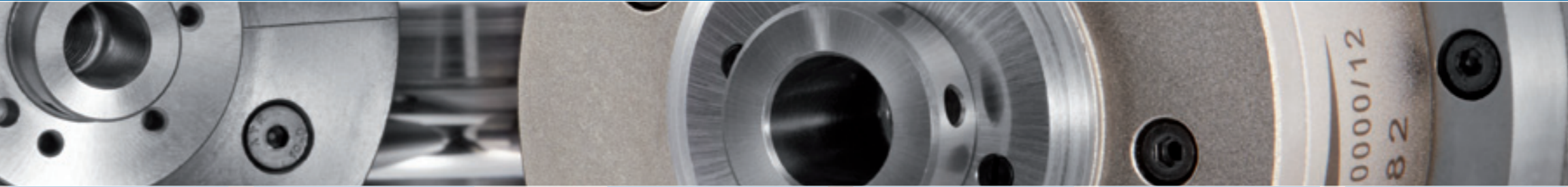

TECHNICAL DATA	
Spindle housing Ø A [mm]	120
Speed max. n _{max} [rpm]	60,000
Bearing Ø front W ₁ [mm]	30
Tool interface	HSK-C 25
Flat contact face Ø W [mm]	25
Static rigidity	
axial C _{ax} [N/µm]	69
radial C _{rad} [N/µm]	97
Motor design	
Frequency max. f _{max} [Hz]	2,000
Nominal converter voltage ¹⁾ [V]	200 350 460
Power P _{S1} [kW]	11
Torque M _{S1} [Nm]	3.5
... at speed n [rpm]	30,000
Current I _{S1} [A]	58 33 25
Power P _{S6-60%} [kW]	13
Torque M _{S6-60%} [Nm]	4.14
... at speed n [rpm]	30,000
Current I _{S6-60%} [A]	65 37 28

Electrical connection	
Plug type	MAC GA GA
Straight plug-in connection	+ + +
Angle plug-in connection	x x x
Fixed cable XXm	o o o
Coolant through the shaft	
Low pressure (du)	-
High pressure (dh)	o
Sensor technology	
Rotary encoder	o
Speed sensor	+
Housing	
Cylindrical housing	+
Cylindrical housing with flange	o
Block housing	x
Air purge	o

¹⁾ Minimum required output voltage of the frequency converter

- + Standard
- o Option
- x on request

HV-P 120 - 60000/13			
120			
60,000			
30			
HSK-C 25			
25			
69			
97			
200 V	350 V	460 V	
2,000			
200	350	460	
11			
3.5			
30,000			
58	33	25	
13			
4.14			
30,000			
65	37	28	

Electrical connection			
MAC	GA	GA	
+	+	+	
x	x	x	
o	o	o	
Coolant through the shaft			
-			
o			
o			
+			
+			
o			
x			
o			

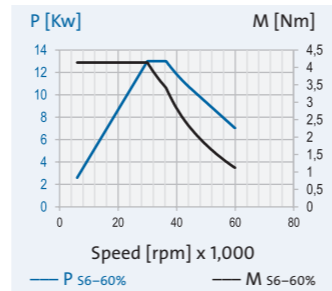

HV-P 120 - 60000/12			
120			
60,000			
30			
HSK-C 25			
25			
69			
97			
200 V	350 V	460 V	
1,000			
200	350	460	
10.5			
1.97			
51,000			
44	25	19	
12			
2.25			
51,000			
51	29	22	

Electrical connection			
GA	GA	GA	
+	+	+	
o	o	o	
o	o	o	
Coolant through the shaft			
-			
o			
o			
+			
+			
o			
x			
o			

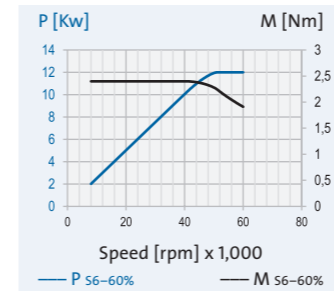

HV-P 120 - 45000/18			
120			
45,000			
45			
HSK-C 40			
40			
91			
125			
200 V	350 V	460 V	
1,500			
200	350	460	
15			
4.77			
30,000			
72	41	31	
18			
5.73			
30,000			
89	51	39	

Electrical connection			
MAC	GA	GA	
+	+	+	
o	o	o	
o	o	o	
Coolant through the shaft			
-			
o			
o			
+			
+			
o			
x			
o			

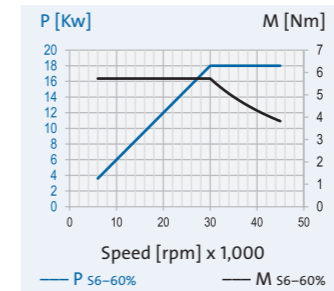

HV-P 120 - 30000/18			
120			
30,000			
55			
HSK-C 50			
50			
99			
145			
200 V	350 V	460 V	
1,000			
200	350	460	
15			
5.97			
24,000			
72	41	31	
18			
7.16			
24,000			
89	51	39	

Electrical connection			
MAC	GA	GA	
+	+	+	
o	o	o	
o	o	o	
Coolant through the shaft			
-			
o			
o			
+			
+			
o			
x			
o			

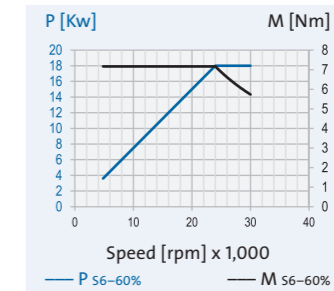

TECHNICAL DATA	
Spindle housing Ø A [mm]	120
Speed max. n _{max} [rpm]	30,000
Bearing Ø front W ₁ [mm]	55
Tool interface	HSK-C 50
Flat contact face Ø W [mm]	50
Static rigidity	
axial C _{ax} [N/µm]	99
radial C _{rad} [N/µm]	145
Motor design	
Frequency max. f _{max} [Hz]	1,000
Nominal converter voltage ¹⁾ [V]	200 350 460
Power P _{S1} [kW]	15
Torque M _{S1} [Nm]	5.97
... at speed n [rpm]	24,000
Current I _{S1} [A]	72 41 31
Power P _{S6-60%} [kW]	18
Torque M _{S6-60%} [Nm]	7.16
... at speed n [rpm]	24,000
Current I _{S6-60%} [A]	89 51 39

Electrical connection	
Plug type	MAC GA GA
Straight plug-in connection	+ + +
Angle plug-in connection	x x x
Fixed cable XXm	o o o
Coolant through the shaft	
Low pressure (du)	-
High pressure (dh)	o
Sensor technology	
Rotary encoder	o
Speed sensor	+
Housing	
Cylindrical housing	+
Cylindrical housing with flange	o
Block housing	x
Air purge	o

¹⁾ Minimum required output voltage of the frequency converter

- + Standard
- o Option
- x on request

Series: HV-P

Cylindrical housing:
Ø = 150 mm

Tool interface:
HSK-C

Motor:
Asynchronous motor

Bearing arrangement:
GMN high precision ball bearings

Lubrication:
Oil-air lubrication

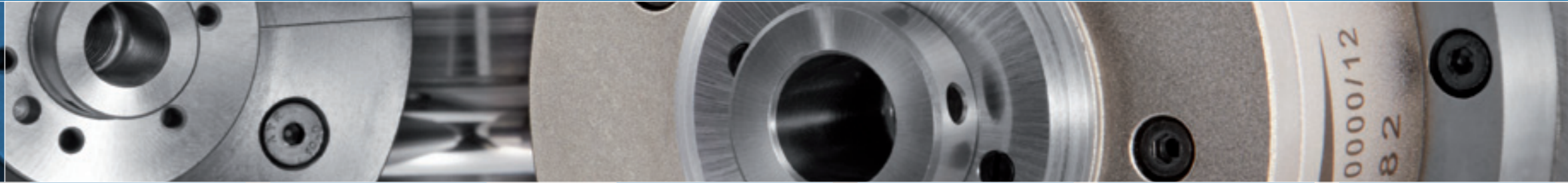

TECHNICAL DATA	
Spindle housing Ø A	[mm]
Speed max. n _{max}	[rpm]
Bearing Ø front W ₁	[mm]
Tool interface	
Flat contact face Ø W	[mm]
Static rigidity	
axial C _{ax}	[N/µm]
radial C _{rad}	[N/µm]
Motor design	
Frequency max. f _{max}	[Hz]
Nominal converter voltage ¹⁾	[V]
Power P _{S1}	[kW]
Torque M _{S1}	[Nm]
... at speed n	[rpm]
Current I _{S1}	[A]
Power P _{S6-60%}	[kW]
Torque M _{S6-60%}	[Nm]
... at speed n	[rpm]
Current I _{S6-60%}	[A]

HV-P 150 - 45000/36			
150			
45,000			
45			
HSK-C 40			
40			
91			
150			
200 V	350 V	460 V	
1,500			
200	350	460	
32			
10.2			
30,000			
152	87	66	
36			
11.5			
30,000			
166	95	72	

HV-P 150 - 45000/25			
150			
45,000			
45			
HSK-C 40			
40			
91			
150			
200 V	350 V	460 V	
1,500			
200	350	460	
22			
10			
21,000			
105	60	46	
25			
11.4			
21,000			
117	67	51	

HV-P 150 - 30000/37			
150			
30,000			
65			
HSK-C 63			
63			
121			
197			
200 V	350 V	460 V	
1,000			
200	350	460	
33			
15			
21,000			
147	84	64	
37			
16.8			
21,000			
161	92	70	

HV-P 150 - 30000/26			
150			
30,000			
65			
HSK-C 63			
63			
121			
197			
200 V	350 V	460 V	
1,000			
200	350	460	
23			
14.6			
15,000			
105	60	46	
26			
16.6			
15,000			
117	67	51	

TECHNICAL DATA	
Spindle housing Ø A	[mm]
Speed max. n _{max}	[rpm]
Bearing Ø front W ₁	[mm]
Tool interface	
Flat contact face Ø W	[mm]
Static rigidity	
axial C _{ax}	[N/µm]
radial C _{rad}	[N/µm]
Motor design	
Frequency max. f _{max}	[Hz]
Nominal converter voltage ¹⁾	[V]
Power P _{S1}	[kW]
Torque M _{S1}	[Nm]
... at speed n	[rpm]
Current I _{S1}	[A]
Power P _{S6-60%}	[kW]
Torque M _{S6-60%}	[Nm]
... at speed n	[rpm]
Current I _{S6-60%}	[A]

Electrical connection	
Plug type	
Straight plug-in connection	
Angle plug-in connection	
Fixed cable XXm	
Coolant through the shaft	
Low pressure (du)	
High pressure (dh)	
Sensor technology	
Rotary encoder	
Speed sensor	
Housing	
Cylindrical housing	
Cylindrical housing with flange	
Block housing	
Air purge	

D500	D500	MAC
+	+	+
o	o	o
o	o	o
-		
o		
o		
+		
+		
o		
x		
o		

D500	MAC	MAC
+	+	+
o	o	o
o	o	o
-		
o		
o		
+		
+		
o		
x		
o		

D500	MAC	MAC
+	+	+
o	o	o
o	o	o
-		
o		
o		
+		
+		
o		
x		
o		

D500	MAC	MAC
+	+	+
o	o	o
o	o	o
-		
o		
o		
+		
+		
o		
x		
o		

Electrical connection	
Plug type	
Straight plug-in connection	
Angle plug-in connection	
Fixed cable XXm	
Coolant through the shaft	
Low pressure (du)	
High pressure (dh)	
Sensor technology	
Rotary encoder	
Speed sensor	
Housing	
Cylindrical housing	
Cylindrical housing with flange	
Block housing	
Air purge	

¹⁾ Minimum required output voltage of the frequency converter

- + Standard
- o Option
- x on request

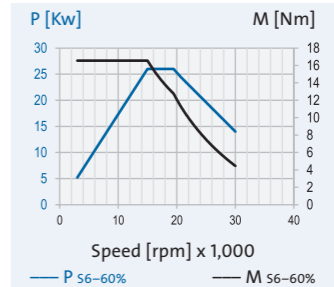
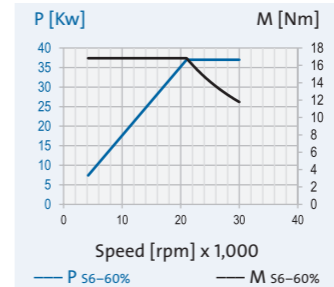
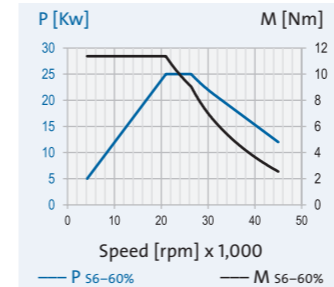
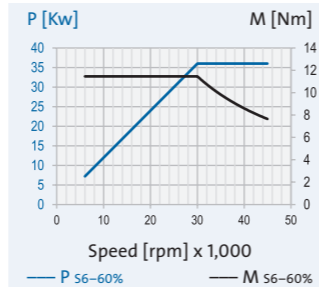

¹⁾ Minimum required output voltage of the frequency converter

- + Standard
- o Option
- x on request

Series: HSP

Cylindrical housing:
Ø = 100 mm

Tool interface:
HSK-C

Motor:
Asynchronous motor

Bearing arrangement:
GMN high precision ball bearings

Lubrication:
Oil-air lubrication

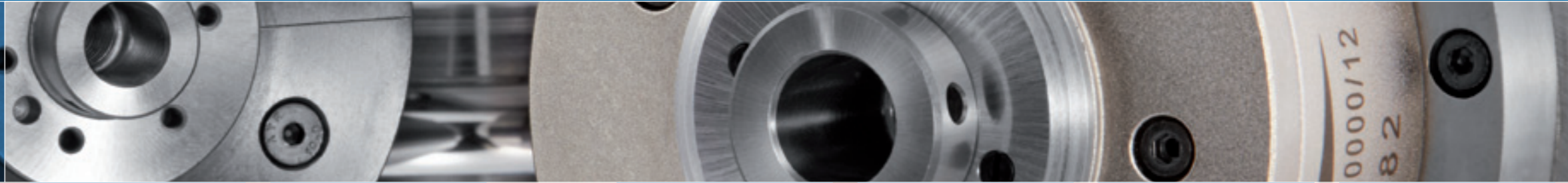

TECHNICAL DATA	
Spindle housing Ø A	[mm]
Speed max. n_{max}	[rpm]
Bearing Ø front W_1	[mm]
Tool interface	
Flat contact face Ø W	[mm]
Static rigidity	
axial C_{ax}	[N/µm]
radial C_{rad}	[N/µm]
Motor design	
Frequency max. f_{max}	[Hz]
Nominal converter voltage ¹⁾	[V]
Power P_{S1}	[kW]
Torque M_{S1}	[Nm]
... at speed n	[rpm]
Current I_{S1}	[A]
Power $P_{S6-60\%}$	[kW]
Torque $M_{S6-60\%}$	[Nm]
... at speed n	[rpm]
Current $I_{S6-60\%}$	[A]

HSP 100 - 51000/5			
100			
51,000			
30			
HSK-C 25			
25			
63			
77			
200 V	350 V	460 V	
1,700			
200	350	460	
5			
1.33			
36,000			
26	15	11	
6			
1.59			
36,000			
32	18	14	

HSP 100 - 51000/3			
100			
51,000			
30			
HSK-C 25			
25			
63			
77			
200 V	350 V	460 V	
1,700			
200	350	460	
3			
1.36			
21,000			
18	10	7,6	
4			
1.59			
24,000			
21	12	9.1	

HSP 100 - 42000/5			
100			
42,000			
35			
HSK-C 32			
32			
69			
81			
200 V	350 V	460 V	
1,400			
200	350	460	
5			
1.33			
36,000			
26	15	11	
6			
1.59			
36,000			
32	18	14	

HSP 100 - 42000/3			
100			
42,000			
35			
HSK-C 32			
32			
69			
81			
200 V	350 V	460 V	
1,400			
200	350	460	
3			
1.36			
21,000			
18	10	7.6	
4			
1.59			
24,000			
21	12	9.1	

TECHNICAL DATA	
Spindle housing Ø A	[mm]
Speed max. n_{max}	[rpm]
Bearing Ø front W_1	[mm]
Tool interface	
Flat contact face Ø W	[mm]
Static rigidity	
axial C_{ax}	[N/µm]
radial C_{rad}	[N/µm]
Motor design	
Frequency max. f_{max}	[Hz]
Nominal converter voltage ¹⁾	[V]
Power P_{S1}	[kW]
Torque M_{S1}	[Nm]
... at speed n	[rpm]
Current I_{S1}	[A]
Power $P_{S6-60\%}$	[kW]
Torque $M_{S6-60\%}$	[Nm]
... at speed n	[rpm]
Current $I_{S6-60\%}$	[A]

Electrical connection	
Plug type	
Straight plug-in connection	
Angle plug-in connection	
Fixed cable XXm	
Coolant through the shaft	
Low pressure (du)	
High pressure (dh)	
Sensor technology	
Rotary encoder	
Speed sensor	
Housing	
Cylindrical housing	
Cylindrical housing with flange	
Block housing	
Air purge	

GA	GA	GA
+	+	+
o	o	o
o	o	o
-		
x		
-		
+		
+		
o		
x		
o		

GA	GA	GA
+	+	+
o	o	o
o	o	o
-		
x		
-		
+		
+		
o		
x		
o		

GA	GA	GA
+	+	+
o	o	o
o	o	o
-		
x		
-		
+		
+		
o		
x		
o		

GA	GA	GA
+	+	+
o	o	o
o	o	o
-		
x		
-		
+		
+		
o		
x		
o		

Electrical connection	
Plug type	
Straight plug-in connection	
Angle plug-in connection	
Fixed cable XXm	
Coolant through the shaft	
Low pressure (du)	
High pressure (dh)	
Sensor technology	
Rotary encoder	
Speed sensor	
Housing	
Cylindrical housing	
Cylindrical housing with flange	
Block housing	
Air purge	

¹⁾ Minimum required output voltage of the frequency converter

- + Standard
- o Option
- x on request

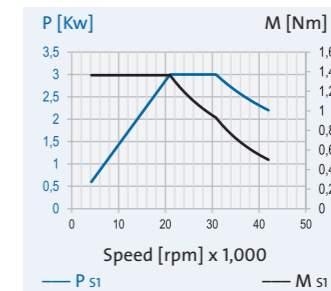
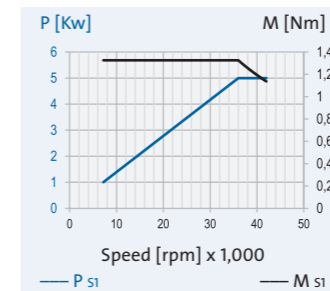
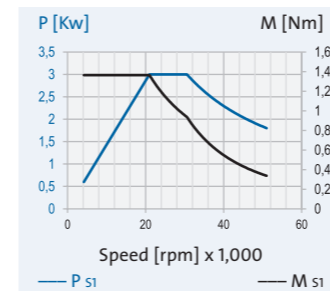
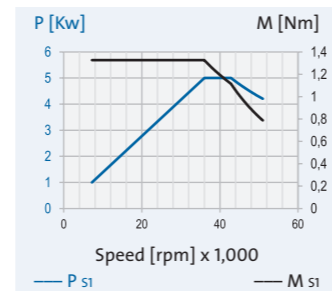

¹⁾ Minimum required output voltage of the frequency converter

- + Standard
- o Option
- x on request

Series: HSP

Cylindrical housing:
Ø = 120 mm

Tool interface:
HSK-C

Motor:
Asynchronous motor

Bearing arrangement:
GMN high precision
ball bearings

Lubrication:
Oil-air lubrication

TECHNICAL DATA	
Spindle housing Ø A	[mm]
Speed max. n_{max}	[rpm]
Bearing Ø front W_1	[mm]
Tool interface	
Flat contact face Ø W	[mm]
Static rigidity	
axial C_{ax}	[N/µm]
radial C_{rad}	[N/µm]
Motor design	
Frequency max. f_{max}	[Hz]
Nominal converter voltage ¹⁾	[V]
Power P_{S1}	[kW]
Torque M_{S1}	[Nm]
... at speed n	[rpm]
Current I_{S1}	[A]
Power $P_{S6-60\%}$	[kW]
Torque $M_{S6-60\%}$	[Nm]
... at speed n	[rpm]
Current $I_{S6-60\%}$	[A]

Electrical connection	
Plug type	
Straight plug-in connection	
Angle plug-in connection	
Fixed cable XXm	
Coolant through the shaft	
Low pressure (du)	
High pressure (dh)	
Sensor technology	
Rotary encoder	
Speed sensor	
Housing	
Cylindrical housing	
Cylindrical housing with flange	
Block housing	
Air purge	

¹⁾ Minimum required output voltage of the frequency converter

- + Standard
- o Option
- x on request

HSP 120 - 51000/11			
120			
51,000			
30			
HSK-C 25			
25			
70			
102			
200 V	350 V	460 V	
1,700			
200	350	460	
11			
3.5			
30,000			
63	36	27	
12			
3.82			
30,000			
67	38	29	

MAC	GA	GA
+	+	+
o	o	o
o	o	o
-		
o		
-		
o		
-		
x		
+		
-		
+		
o		
o		
x		
o		

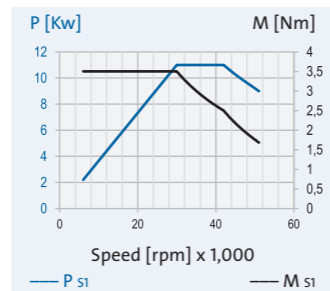

HSP 120 - 51000/6			
120			
51,000			
30			
HSK-C 25			
25			
70			
102			
200 V	350 V	460 V	
1,700			
200	350	460	
6			
3.18			
18,000			
30	17	13	
7			
3.71			
18,000			
35	20	15	

MAC	GA	GA
+	+	+
o	o	o
o	o	o
-		
o		
-		
o		
-		
x		
+		
-		
+		
o		
o		
x		
o		

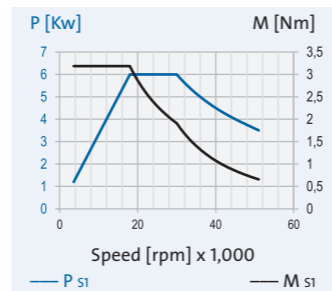

HSP 120 - 42000/11			
120			
42,000			
40			
HSK-C 32			
32			
90			
121			
200 V	350 V	460 V	
1,400			
200	350	460	
11			
3.5			
30,000			
63	36	27	
12			
3.82			
30,000			
67	38	29	

MAC	GA	GA
+	+	+
o	o	o
o	o	o
-		
o		
-		
o		
-		
x		
+		
-		
+		
o		
o		
x		
o		

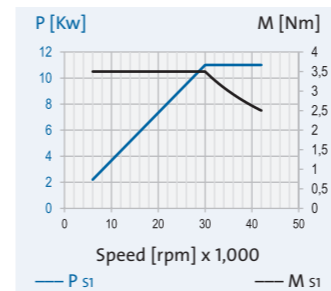

HSP 120 - 42000/6			
120			
42,000			
40			
HSK-C 32			
32			
90			
121			
200 V	350 V	460 V	
1,400			
200	350	460	
6			
3.18			
18,000			
30	17	13	
7			
3.71			
18,000			
35	20	15	

MAC	GA	GA
+	+	+
o	o	o
o	o	o
-		
o		
-		
o		
-		
x		
+		
-		
+		
o		
o		
x		
o		

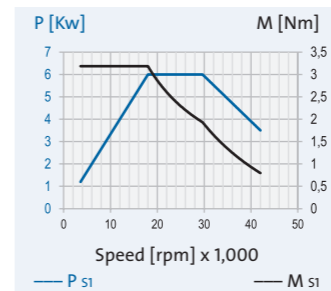

HSP 120 - 30000/11			
120			
30,000			
45			
HSK-C 40			
40			
98			
131			
200 V	350 V	460 V	
1,500			
200	350	460	
11			
5.84			
18,000			
72	41	31	
13			
6.9			
18,000			
84	48	37	

MAC	GA	GA
+	+	+
o	o	o
o	o	o
-		
o		
-		
o		
-		
x		
+		
-		
+		
o		
o		
x		
o		

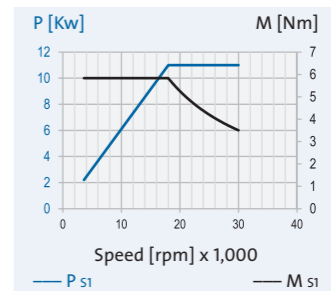

HSP 120 - 30000/9			
120			
30,000			
45			
HSK-C 40			
40			
98			
131			
200 V	350 V	460 V	
1,500			
200	350	460	
9			
5.73			
15,000			
58	33	25	
11			
7			
15,000			
68	39	30	

MAC	GA	GA
+	+	+
o	o	o
o	o	o
-		
o		
-		
o		
-		
x		
+		
-		
+		
o		
o		
x		
o		

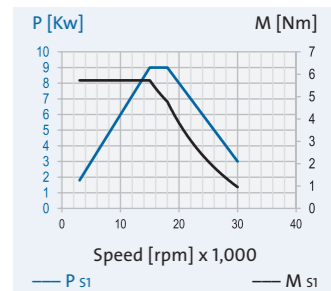

Series: HSP

Cylindrical housing:
Ø = 150 mm

Tool interface:
HSK-C

Motor:
Asynchronous motor

Bearing arrangement:
GMN high precision
ball bearings

Lubrication:
Oil-air lubrication

TECHNICAL DATA	
Spindle housing Ø A	[mm]
Speed max. n_{max}	[rpm]
Bearing Ø front W_1	[mm]
Tool interface	
Flat contact face Ø W	[mm]
Static rigidity	
axial C_{ax}	[N/µm]
radial C_{rad}	[N/µm]
Motor design	
Frequency max. f_{max}	[Hz]
Nominal converter voltage ¹⁾	[V]
Power P_{S1}	[kW]
Torque M_{S1}	[Nm]
... at speed n	[rpm]
Current I_{S1}	[A]
Power $P_{S6-60\%}$	[kW]
Torque $M_{S6-60\%}$	[Nm]
... at speed n	[rpm]
Current $I_{S6-60\%}$	[A]

Electrical connection	
Plug type	
Straight plug-in connection	
Angle plug-in connection	
Fixed cable XXm	
Coolant through the shaft	
Low pressure (du)	
High pressure (dh)	
Sensor technology	
Rotary encoder	
Speed sensor	
Housing	
Cylindrical housing	
Cylindrical housing with flange	
Block housing	
Air purge	

¹⁾ Minimum required output voltage of the frequency converter

- + Standard
- o Option
- x on request

HSP 150 - 42000/14			
150			
42,000			
40			
HSK-C 32			
32			
90			
147			
200 V	350 V	460 V	
1,400			
200	350	460	
14			
4.95			
27,000			
86	49	37	
16			
5.66			
27,000			
102	58	44	

MAC			GA		
+	+	+	+	+	+
o	o	o	o	o	o
o	o	o	o	o	o
-					
o					
x					
+					
+					
o					
o					
o					

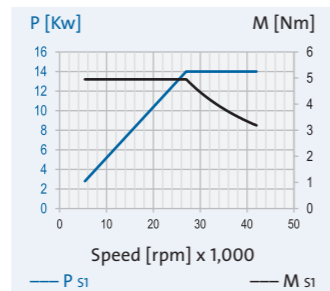

HSP 150 - 42000/9.5			
150			
42,000			
40			
HSK-C 32			
32			
90			
147			
200 V	350 V	460 V	
1,400			
200	350	460	
9.5			
5.04			
18,000			
47	27	21	
11			
5.84			
18,000			
54	31	24	

MAC		GA		GA	
+	+	+	+	+	+
o	o	o	o	o	o
o	o	o	o	o	o
-					
o					
x					
+					
+					
o					
o					
o					

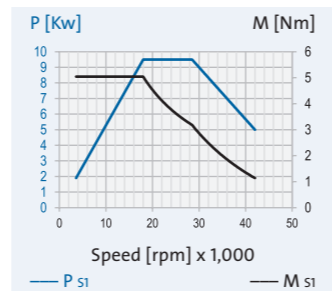

HSP 150 - 30000/18			
150			
30,000			
55			
HSK-C 50			
50			
111			
177			
200 V	350 V	460 V	
1,000			
200	350	460	
18			
9.55			
18,000			
86	49	37	
23			
12.2			
18,000			
110	63	48	

MAC			GA		
+	+	+	+	+	+
o	o	o	o	o	o
o	o	o	o	o	o
-					
o					
x					
+					
+					
o					
o					
o					

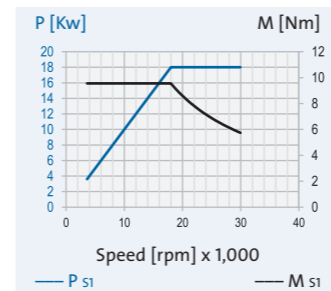

HSP 150 - 30000/14			
150			
30,000			
55			
HSK-C 50			
50			
111			
177			
200 V	350 V	460 V	
1,000			
200	350	460	
14			
9.9			
13,500			
63	36	27	
16			
11.3			
13,500			
70	40	30	

MAC			GA		
+	+	+	+	+	+
o	o	o	o	o	o
o	o	o	o	o	o
-					
o					
x					
+					
+					
o					
o					
o					

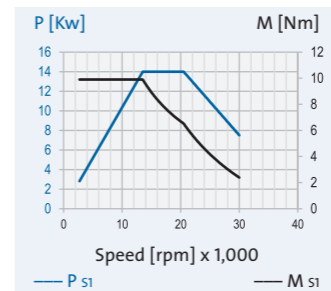

HSP 150 - 24000/18			
150			
24,000			
65			
HSK-C 63			
63			
130			
196			
200 V	350 V	460 V	
800			
200	350	460	
18			
9.55			
18,000			
86	49	37	
23			
12.2			
18,000			
110	63	48	

MAC			GA		
+	+	+	+	+	+
o	o	o	o	o	o
o	o	o	o	o	o
-					
o					
x					
+					
+					
o					
o					
o					

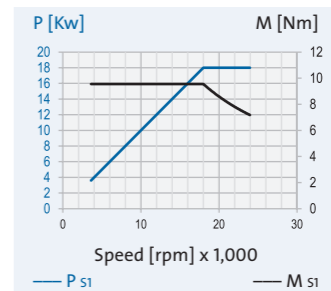

HSP 150 - 24000/14			
150			
24,000			
65			
HSK-C 63			
63			
130			
196			
200 V	350 V	460 V	
800			
200	350	460	
14			
12.2			
11,000			
65	37	28	
17			
14.8			
11,000			
79	45	34	

MAC			GA		
+	+	+	+	+	+
o	o	o	o	o	o
o	o	o	o	o	o
-					
o					
x					
+					
+					
o					
o					
o					

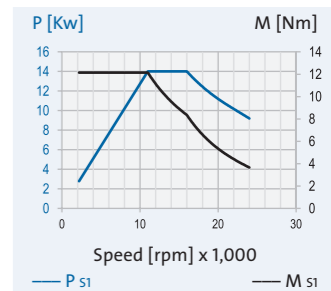

Series: HSP

Cylindrical housing:
Ø = 170 mm

Tool interface:
HSK-C

Motor:
Asynchronous motor

Bearing arrangement:
GMN high precision
ball bearings

Lubrication:
Oil-air lubrication

TECHNICAL DATA	
Spindle housing Ø A	[mm]
Speed max. n_{max}	[rpm]
Bearing Ø front W_1	[mm]
Tool interface	
Flat contact face Ø W	[mm]
Static rigidity	
axial C_{ax}	[N/µm]
radial C_{rad}	[N/µm]
Motor design	
Frequency max. f_{max}	[Hz]
Nominal converter voltage ¹⁾	[V]
Power P_{S1}	[kW]
Torque M_{S1}	[Nm]
... at speed n	[rpm]
Current I_{S1}	[A]
Power $P_{S6-60\%}$	[kW]
Torque $M_{S6-60\%}$	[Nm]
... at speed n	[rpm]
Current $I_{S6-60\%}$	[A]

Electrical connection	
Plug type	
Straight plug-in connection	
Angle plug-in connection	
Fixed cable XXm	
Coolant through the shaft	
Low pressure (du)	
High pressure (dh)	
Sensor technology	
Rotary encoder	
Speed sensor	
Housing	
Cylindrical housing	
Cylindrical housing with flange	
Block housing	
Air purge	

¹⁾ Minimum required output voltage of the frequency converter

- + Standard
- o Option
- x on request

HSP 170 - 30000/32			
170			
30,000			
55			
HSK-C 50			
50			
111			
203			
200 V	350 V	460 V	
1,000			
200	350	460	
32			
20.4			
15,000			
140	80	61	
35			
22.3			
15,000			
151	86	65	

D500	MAC	MAC
+	+	+
o	o	o
o	o	o
-		
o		
-		
o		
-		
x		
+		
+		
o		
o		
o		

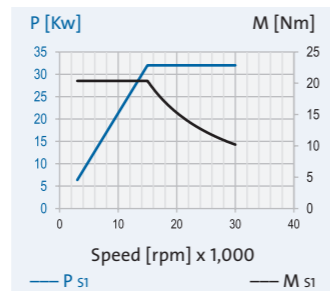

HSP 170 - 30000/19			
170			
30,000			
55			
HSK-C 50			
50			
111			
203			
200 V	350 V	460 V	
1,000			
200	350	460	
19			
20.2			
9,000			
82	47	36	
21			
22.3			
9,000			
93	53	40	

MAC	MAC	GA
+	+	+
o	o	o
o	o	o
-		
o		
-		
x		
+		
+		
o		
o		
o		

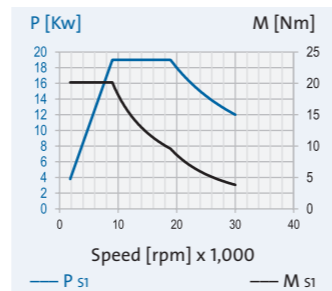

HSP 170 - 24000/32			
170			
24,000			
65			
HSK-C 63			
63			
130			
231			
200 V	350 V	460 V	
800			
200	350	460	
32			
20.4			
15,000			
140	80	61	
35			
22.3			
15,000			
151	86	65	

D500	MAC	MAC
+	+	+
o	o	o
o	o	o
-		
o		
-		
x		
+		
+		
o		
o		
o		

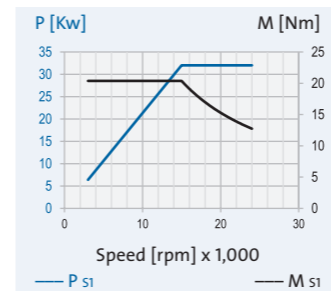

HSP 170 - 24000/19			
170			
24,000			
65			
HSK-C 63			
63			
130			
231			
200 V	350 V	460 V	
800			
200	350	460	
19			
20.2			
9,000			
82	47	36	
21			
22.3			
9,000			
93	53	40	

MAC	MAC	GA
+	+	+
o	o	o
o	o	o
-		
o		
-		
x		
+		
+		
o		
o		
o		

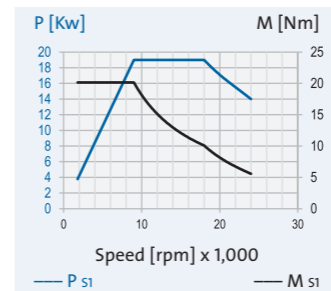

HSP 170 - 18000/29			
170			
18,000			
70			
HSK-C 63			
63			
201			
325			
200 V	350 V	460 V	
600			
200	350	460	
29			
25.2			
11,000			
117	67	51	
34			
29.5			
11,000			
137	78	59	

D500	MAC	MAC
+	+	+
o	o	o
o	o	o
-		
o		
-		
x		
+		
+		
o		
o		
o		

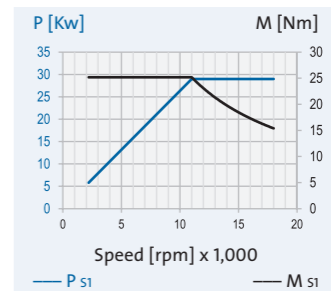

HSP 170 - 18000/20			
170			
18,000			
70			
HSK-C 63			
63			
201			
325			
200 V	350 V	460 V	
600			
200	350	460	
20			
25.5			
7,500			
89	51	39	
23			
29.3			
7,500			
102	58	44	

D500	MAC	GA
+	+	+
o	o	o
o	o	o
-		
o		
-		
x		
+		
+		
o		
o		
o		

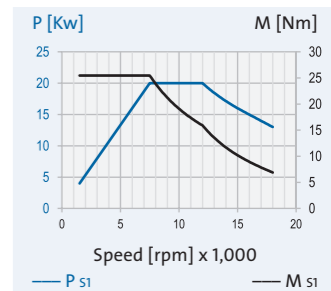

Series: HSP

Cylindrical housing:
Ø = 230 mm

Tool interface:
HSK-C

Motor:
Asynchronous motor

Bearing arrangement:
GMN high precision ball bearings

Lubrication:
Oil-air lubrication

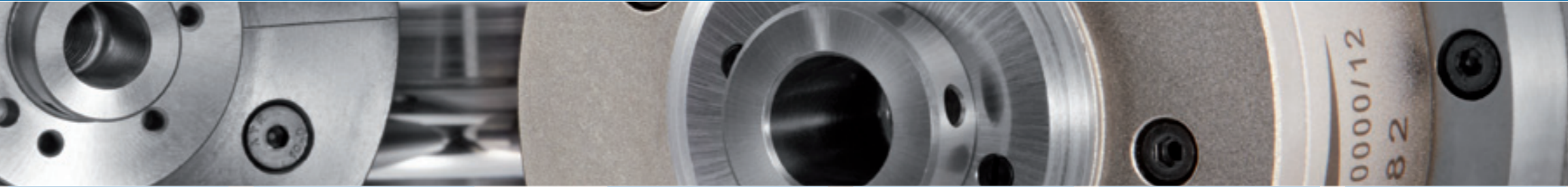

TECHNICAL DATA	
Spindle housing Ø A [mm]	230
Speed max. n _{max} [rpm]	18,000
Bearing Ø front W ₁ [mm]	70
Tool interface	HSK-C 63
Flat contact face Ø W [mm]	63
Static rigidity	
axial C _{ax} [N/µm]	196
radial C _{rad} [N/µm]	375
Motor design	
Frequency max. f _{max} [Hz]	600
Nominal converter voltage ¹⁾ [V]	200
Power P _{S1} [kW]	45
Torque M _{S1} [Nm]	58.9
... at speed n [rpm]	7,300
Current I _{S1} [A]	172
Power P _{S6-60%} [kW]	50
Torque M _{S6-60%} [Nm]	65.4
... at speed n [rpm]	7,300
Current I _{S6-60%} [A]	189

Electrical connection	
Plug type	-
Straight plug-in connection	-
Angle plug-in connection	-
Fixed cable XXm	+
Coolant through the shaft	
Low pressure (du)	-
High pressure (dh)	o
Sensor technology	
Rotary encoder	x
Speed sensor	+
Housing	
Cylindrical housing	+
Cylindrical housing with flange	o
Block housing	x
Air purge	o

¹⁾ Minimum required output voltage of the frequency converter

- + Standard
- o Option
- x on request

HSP 230 - 18000/45			
200 V	350 V	-	
200	350	-	
172	98	-	
189	108	-	

-	D500	-
-	+	-
-	o	-
+	o	-
-	-	-
o	o	-
-	-	-
o	o	-
-	-	-
x	x	-
+	+	-
-	-	-
+	+	-
o	o	-
x	x	-
o	o	-

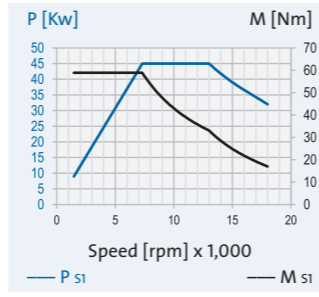

HSP 230 - 18000/18			
200 V	350 V	-	
200	350	-	
100	57	-	
112	64	-	

D500	MAC	-
+	+	-
o	o	-
o	o	-
-	-	-
-	-	-
-	-	-
+	o	-
-	-	-
-	-	-
x	x	-
+	+	-
-	-	-
+	+	-
o	o	-
x	x	-
o	o	-

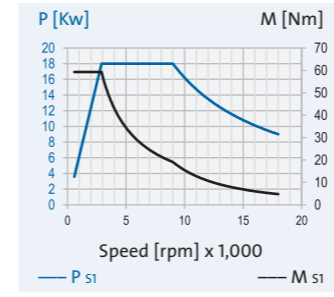

HSP 230 - 15000/42			
200 V	350 V	-	
200	350	-	
168	96	-	
187	107	-	

-	D500	-
-	+	-
-	o	-
+	o	-
-	-	-
-	-	-
-	-	-
+	o	-
-	-	-
-	-	-
x	x	-
+	+	-
-	-	-
+	+	-
o	o	-
x	x	-
o	o	-

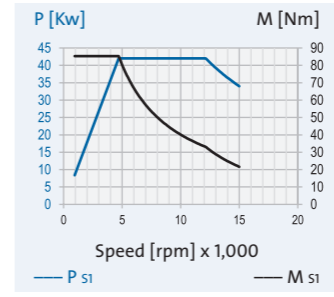

HSP 230 - 15000/25			
200 V	350 V	-	
200	350	-	
121	69	-	
135	77	-	

D500	MAC	-
+	+	-
o	o	-
o	o	-
-	-	-
-	-	-
-	-	-
o	o	-
-	-	-
-	-	-
x	x	-
+	+	-
-	-	-
+	+	-
o	o	-
x	x	-
o	o	-

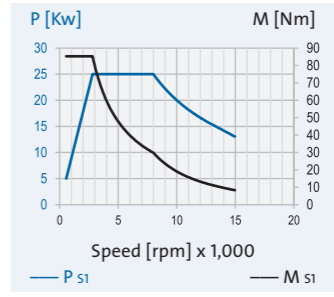

TECHNICAL DATA	
Spindle housing Ø A [mm]	230
Speed max. n _{max} [rpm]	15,000
Bearing Ø front W ₁ [mm]	90
Tool interface	HSK-C 80
Flat contact face Ø W [mm]	80
Static rigidity	
axial C _{ax} [N/µm]	461
radial C _{rad} [N/µm]	483
Motor design	
Frequency max. f _{max} [Hz]	500
Nominal converter voltage ¹⁾ [V]	200
Power P _{S1} [kW]	25
Torque M _{S1} [Nm]	85.3
... at speed n [rpm]	2,800
Current I _{S1} [A]	121
Power P _{S6-60%} [kW]	28
Torque M _{S6-60%} [Nm]	95.5
... at speed n [rpm]	2,800
Current I _{S6-60%} [A]	135

Electrical connection	
Plug type	-
Straight plug-in connection	-
Angle plug-in connection	-
Fixed cable XXm	+
Coolant through the shaft	
Low pressure (du)	-
High pressure (dh)	o
Sensor technology	
Rotary encoder	x
Speed sensor	+
Housing	
Cylindrical housing	+
Cylindrical housing with flange	o
Block housing	x
Air purge	o

¹⁾ Minimum required output voltage of the frequency converter

- + Standard
- o Option
- x on request

Series: HSP..g

Cylindrical housing:
Ø = 100 mm

Tool interface:
HSK-C

Motor:
Asynchronous motor

Bearing arrangement:
GMN high precision ball bearings

Lubrication:
Permanent grease lubrication

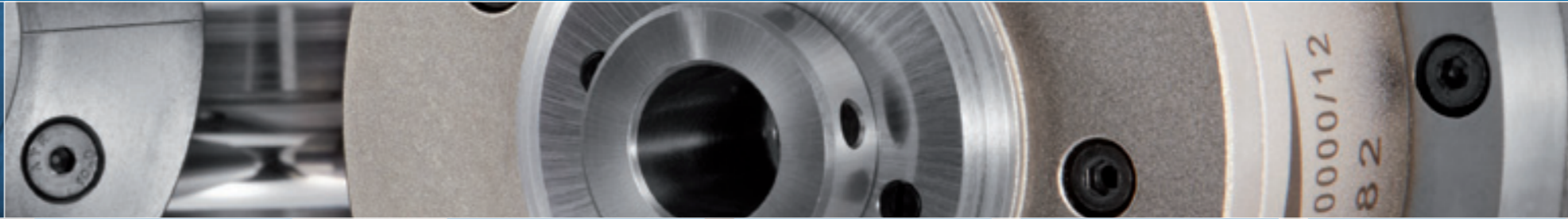

TECHNICAL DATA	
Spindle housing Ø A	[mm]
Speed max. n _{max}	[rpm]
Bearing Ø front W ₁	[mm]
Tool interface	
Flat contact face Ø W	[mm]
Static rigidity	
axial C _{ax}	[N/µm]
radial C _{rad}	[N/µm]
Motor design	
Frequency max. f _{max}	[Hz]
Nominal converter voltage ¹⁾ [V]	
Power P _{s1}	[kW]
Torque M _{s1}	[Nm]
... at speed n	[rpm]
Current I _{s1}	[A]
Power P _{S6-60%}	[kW]
Torque M _{S6-60%}	[Nm]
... at speed n	[rpm]
Current I _{S6-60%}	[A]

Electrical connection	
Plug type	
Straight plug-in connection	
Angle plug-in connection	
Fixed cable XXm	
Coolant through the shaft	
Low pressure (du)	
High pressure (dh)	
Sensor technology	
Rotary encoder	
Speed sensor	
Housing	
Cylindrical housing	
Cylindrical housing with flange	
Block housing	
Air purge	

¹⁾ Minimum required output voltage of the frequency converter

- + Standard
- o Option
- x on request

HSP 100g - 30000/3		
100		
30,000		
30		
HSK-C 25		
25		
63		
77		
200 V	350 V	-
1,000		
200	350	-
3		
1.36		
21,000		
18	10	-
4		
1.59		
24,000		
21	12	-

GA	GA	-
+	+	-
o	o	-
o	o	-
-		
x		
-		
+		
-		
+		
o		
x		
+		

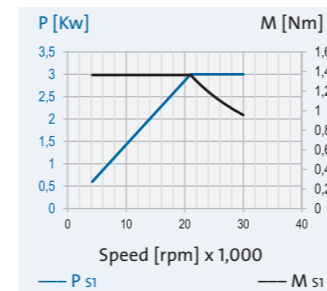

HSP 100g - 27000/3		
100		
27,000		
35		
HSK-C 32		
32		
69		
81		
200 V	350 V	-
900		
200	350	-
3		
1.36		
21,000		
18	10	-
4		
1.59		
24,000		
21	12	-

GA	GA	-
+	+	-
o	o	-
o	o	-
-		
x		
-		
+		
-		
+		
o		
x		
+		

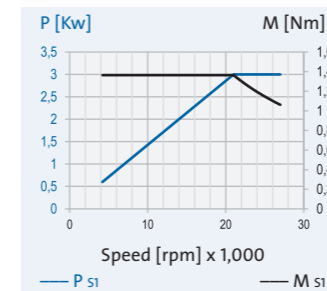

HSP 100g - 21000/3		
100		
21,000		
45		
HSK-C 40		
40		
91		
80		
200 V	350 V	-
700		
200	350	-
3		
2.39		
12,000		
18	10	-
4.5		
2.86		
15,000		
21	12	-

GA	GA	-
+	+	-
o	o	-
o	o	-
-		
x		
-		
+		
-		
+		
o		
x		
+		

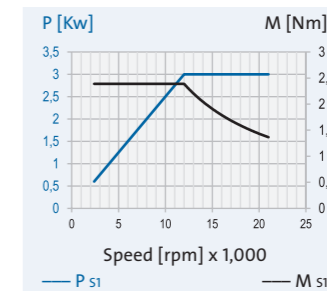

TECHNICAL DATA	
Spindle housing Ø A	[mm]
Speed max. n _{max}	[rpm]
Bearing Ø front W ₁	[mm]
Tool interface	
Flat contact face Ø W	[mm]
Static rigidity	
axial C _{ax}	[N/µm]
radial C _{rad}	[N/µm]
Motor design	
Frequency max. f _{max}	[Hz]
Nominal converter voltage ¹⁾ [V]	
Power P _{s1}	[kW]
Torque M _{s1}	[Nm]
... at speed n	[rpm]
Current I _{s1}	[A]
Power P _{S6-60%}	[kW]
Torque M _{S6-60%}	[Nm]
... at speed n	[rpm]
Current I _{S6-60%}	[A]

Electrical connection	
Plug type	
Straight plug-in connection	
Angle plug-in connection	
Fixed cable XXm	
Coolant through the shaft	
Low pressure (du)	
High pressure (dh)	
Sensor technology	
Rotary encoder	
Speed sensor	
Housing	
Cylindrical housing	
Cylindrical housing with flange	
Block housing	
Air purge	

¹⁾ Minimum required output voltage of the frequency converter

- + Standard
- o Option
- x on request

Series: HSP..g

Cylindrical housing:
Ø = 120 mm

Tool interface:
HSK-C

Motor:
Asynchronous motor

Bearing arrangement:
GMN high precision ball bearings

Lubrication:
Permanent grease lubrication

TECHNICAL DATA	
Spindle housing Ø A	[mm]
Speed max. n_{max}	[rpm]
Bearing Ø front W_1	[mm]
Tool interface	
Flat contact face Ø W	[mm]
Static rigidity	
axial C_{ax}	[N/µm]
radial C_{rad}	[N/µm]
Motor design	
Frequency max. f_{max}	[Hz]
Nominal converter voltage ¹⁾ [V]	
Power P_{S1}	[kW]
Torque M_{S1}	[Nm]
... at speed n	[rpm]
Current I_{S1}	[A]
Power $P_{S6-60\%}$	[kW]
Torque $M_{S6-60\%}$	[Nm]
... at speed n	[rpm]
Current $I_{S6-60\%}$	[A]

Electrical connection	
Plug type	
Straight plug-in connection	
Angle plug-in connection	
Fixed cable XXm	
Coolant through the shaft	
Low pressure (du)	
High pressure (dh)	
Sensor technology	
Rotary encoder	
Speed sensor	
Housing	
Cylindrical housing	
Cylindrical housing with flange	
Block housing	
Air purge	

¹⁾ Minimum required output voltage of the frequency converter

- + Standard
- o Option
- x on request

HSP 120g - 30000/6		
Spindle housing Ø A	120	
Speed max. n_{max}	30,000	
Bearing Ø front W_1	30	
Tool interface		
Flat contact face Ø W	25	
Static rigidity		
axial C_{ax}	70	
radial C_{rad}	102	
Motor design		
Frequency max. f_{max}	1,000	
Nominal converter voltage ¹⁾ [V]		
Power P_{S1}	6	
Torque M_{S1}	3.18	
... at speed n	18,000	
Current I_{S1}	17	13
Power $P_{S6-60\%}$	7	
Torque $M_{S6-60\%}$	3.71	
... at speed n	18,000	
Current $I_{S6-60\%}$	20	15

Electrical connection		
Plug type	GA	GA
Straight plug-in connection	+	+
Angle plug-in connection	o	o
Fixed cable XXm	o	o
Coolant through the shaft		
Low pressure (du)	-	-
High pressure (dh)	x	x
Sensor technology		
Rotary encoder	-	-
Speed sensor	+	+
Housing		
Cylindrical housing	+	+
Cylindrical housing with flange	o	o
Block housing	x	x
Air purge	+	+

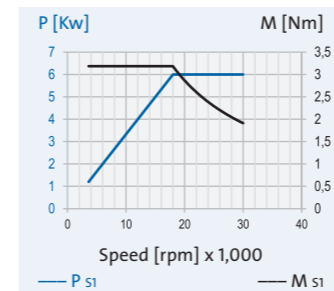

HSP 120g - 24000/6		
Spindle housing Ø A	120	
Speed max. n_{max}	24,000	
Bearing Ø front W_1	40	
Tool interface		
Flat contact face Ø W	32	
Static rigidity		
axial C_{ax}	90	
radial C_{rad}	121	
Motor design		
Frequency max. f_{max}	800	
Nominal converter voltage ¹⁾ [V]		
Power P_{S1}	6	
Torque M_{S1}	3.18	
... at speed n	18,000	
Current I_{S1}	17	13
Power $P_{S6-60\%}$	7	
Torque $M_{S6-60\%}$	3.71	
... at speed n	18,000	
Current $I_{S6-60\%}$	20	15

Electrical connection		
Plug type	GA	GA
Straight plug-in connection	+	+
Angle plug-in connection	o	o
Fixed cable XXm	o	o
Coolant through the shaft		
Low pressure (du)	-	-
High pressure (dh)	x	x
Sensor technology		
Rotary encoder	-	-
Speed sensor	+	+
Housing		
Cylindrical housing	+	+
Cylindrical housing with flange	o	o
Block housing	x	x
Air purge	+	+

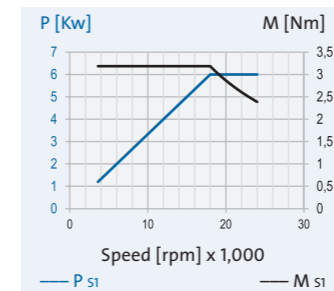

HSP 120g - 21000/9		
Spindle housing Ø A	120	
Speed max. n_{max}	21,000	
Bearing Ø front W_1	45	
Tool interface		
Flat contact face Ø W	40	
Static rigidity		
axial C_{ax}	98	
radial C_{rad}	131	
Motor design		
Frequency max. f_{max}	1,050	
Nominal converter voltage ¹⁾ [V]		
Power P_{S1}	9	
Torque M_{S1}	5.73	
... at speed n	15,000	
Current I_{S1}	70	40
Power $P_{S6-60\%}$	13	30
Torque $M_{S6-60\%}$	6.9	
... at speed n	18,000	
Current $I_{S6-60\%}$	84	37

Electrical connection		
Plug type	MAC	GA
Straight plug-in connection	+	+
Angle plug-in connection	o	o
Fixed cable XXm	o	o
Coolant through the shaft		
Low pressure (du)	-	-
High pressure (dh)	x	x
Sensor technology		
Rotary encoder	-	-
Speed sensor	+	+
Housing		
Cylindrical housing	+	+
Cylindrical housing with flange	o	o
Block housing	x	x
Air purge	+	+

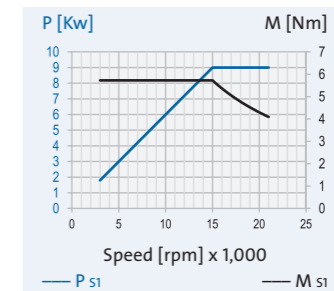

TECHNICAL DATA	
Spindle housing Ø A	[mm]
Speed max. n_{max}	[rpm]
Bearing Ø front W_1	[mm]
Tool interface	
Flat contact face Ø W	[mm]
Static rigidity	
axial C_{ax}	[N/µm]
radial C_{rad}	[N/µm]
Motor design	
Frequency max. f_{max}	[Hz]
Nominal converter voltage ¹⁾ [V]	
Power P_{S1}	[kW]
Torque M_{S1}	[Nm]
... at speed n	[rpm]
Current I_{S1}	[A]
Power $P_{S6-60\%}$	[kW]
Torque $M_{S6-60\%}$	[Nm]
... at speed n	[rpm]
Current $I_{S6-60\%}$	[A]

Electrical connection	
Plug type	
Straight plug-in connection	
Angle plug-in connection	
Fixed cable XXm	
Coolant through the shaft	
Low pressure (du)	
High pressure (dh)	
Sensor technology	
Rotary encoder	
Speed sensor	
Housing	
Cylindrical housing	
Cylindrical housing with flange	
Block housing	
Air purge	

¹⁾ Minimum required output voltage of the frequency converter

- + Standard
- o Option
- x on request

Series: HSP..g

Cylindrical housing:
Ø = 150 mm

Tool interface:
HSK-C

Motor:
Asynchronous motor

Bearing arrangement:
GMN high precision ball bearings

Lubrication:
Permanent grease lubrication

TECHNICAL DATA	
Spindle housing Ø A	[mm]
Speed max. n _{max}	[rpm]
Bearing Ø front W ₁	[mm]
Tool interface	
Flat contact face Ø W	[mm]
Static rigidity	
axial C _{ax}	[N/µm]
radial C _{rad}	[N/µm]
Motor design	
Frequency max. f _{max}	[Hz]
Nominal converter voltage ¹⁾ [V]	
Power P _{s1}	[kW]
Torque M _{s1}	[Nm]
... at speed n	[rpm]
Current I _{s1}	[A]
Power P _{S6-60%}	[kW]
Torque M _{S6-60%}	[Nm]
... at speed n	[rpm]
Current I _{S6-60%}	[A]

Electrical connection	
Plug type	
Straight plug-in connection	
Angle plug-in connection	
Fixed cable XXm	
Coolant through the shaft	
Low pressure (du)	
High pressure (dh)	
Sensor technology	
Rotary encoder	
Speed sensor	
Housing	
Cylindrical housing	
Cylindrical housing with flange	
Block housing	
Air purge	

¹⁾ Minimum required output voltage of the frequency converter

+ Standard
o Option
x on request

HSP 150g - 24000/9.5			
150			
24,000			
40			
HSK-C 32			
32			
90			
147			
200 V	350 V	460 V	
800			
200	350	460	
9.5			
5.04			
18,000			
47	27	21	
11			
5.84			
18,000			
54	31	24	

Electrical connection			
MAC	GA	GA	
+	+	+	
o	o	o	
o	o	o	
Coolant through the shaft			
-			
x			
Sensor technology			
x			
+			
Housing			
+			
o			
x			
+			

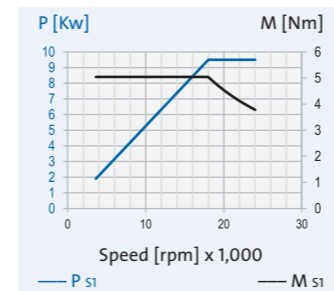

HSP 150g - 18000/14			
150			
18,000			
55			
HSK-C 50			
50			
111			
177			
200 V	350 V	460 V	
600			
200	350	460	
14			
9.9			
13,500			
63	36	27	
16			
11.3			
13,500			
70	40	30	

Electrical connection			
MAC	GA	GA	
+	+	+	
o	o	o	
o	o	o	
Coolant through the shaft			
-			
x			
Sensor technology			
x			
+			
Housing			
+			
o			
x			
+			

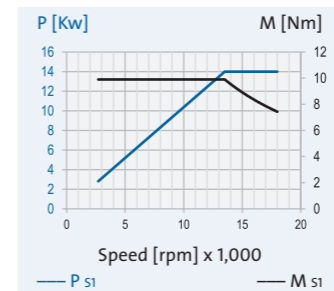

HSP 150g - 15000/14			
150			
15,000			
65			
HSK-C 63			
63			
130			
196			
200 V	350 V	460 V	
500			
200	350	460	
14			
12.2			
11,000			
65	37	28	
17			
14.8			
11,000			
79	45	34	

Electrical connection			
MAC	GA	GA	
+	+	+	
o	o	o	
o	o	o	
Coolant through the shaft			
-			
x			
Sensor technology			
x			
+			
Housing			
+			
o			
x			
+			

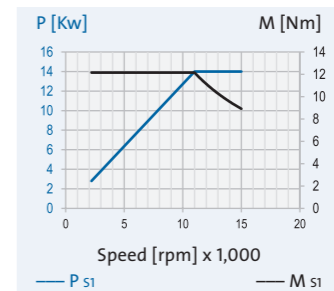

TECHNICAL DATA	
Spindle housing Ø A	[mm]
Speed max. n _{max}	[rpm]
Bearing Ø front W ₁	[mm]
Tool interface	
Flat contact face Ø W	[mm]
Static rigidity	
axial C _{ax}	[N/µm]
radial C _{rad}	[N/µm]
Motor design	
Frequency max. f _{max}	[Hz]
Nominal converter voltage ¹⁾ [V]	
Power P _{s1}	[kW]
Torque M _{s1}	[Nm]
... at speed n	[rpm]
Current I _{s1}	[A]
Power P _{S6-60%}	[kW]
Torque M _{S6-60%}	[Nm]
... at speed n	[rpm]
Current I _{S6-60%}	[A]

Electrical connection	
Plug type	
Straight plug-in connection	
Angle plug-in connection	
Fixed cable XXm	
Coolant through the shaft	
Low pressure (du)	
High pressure (dh)	
Sensor technology	
Rotary encoder	
Speed sensor	
Housing	
Cylindrical housing	
Cylindrical housing with flange	
Block housing	
Air purge	

¹⁾ Minimum required output voltage of the frequency converter

+ Standard
o Option
x on request

Series: HSP..g

Cylindrical housing:
Ø = 170 mm

Tool interface:
HSK-C

Motor:
Asynchronous motor

Bearing arrangement:
GMN high precision ball bearings

Lubrication:
Permanent grease lubrication

TECHNICAL DATA	
Spindle housing Ø A	[mm]
Speed max. n_{max}	[rpm]
Bearing Ø front W_1	[mm]
Tool interface	
Flat contact face Ø W	[mm]
Static rigidity	
axial C_{ax}	[N/µm]
radial C_{rad}	[N/µm]
Motor design	
Frequency max. f_{max}	[Hz]
Nominal converter voltage ¹⁾ [V]	
Power P_{S1}	[kW]
Torque M_{S1}	[Nm]
... at speed n	[rpm]
Current I_{S1}	[A]
Power $P_{S6-60\%}$	[kW]
Torque $M_{S6-60\%}$	[Nm]
... at speed n	[rpm]
Current $I_{S6-60\%}$	[A]

Electrical connection	
Plug type	
Straight plug-in connection	
Angle plug-in connection	
Fixed cable XXm	
Coolant through the shaft	
Low pressure (du)	
High pressure (dh)	
Sensor technology	
Rotary encoder	
Speed sensor	
Housing	
Cylindrical housing	
Cylindrical housing with flange	
Block housing	
Air purge	

¹⁾ Minimum required output voltage of the frequency converter

- + Standard
- o Option
- x on request

HSP 170g - 18000/19			
170			
18,000			
55			
HSK-C 50			
50			
111			
203			
200 V	350 V	460 V	
600			
200	350	460	
19			
20.2			
9,000			
82	47	36	
22			
21			
10,000			
93	53	40	

Electrical connection			
MAC	MAC	GA	
+	+	+	
o	o	o	
o	o	o	
Coolant through the shaft			
Low pressure (du)			
High pressure (dh)			
Sensor technology			
Rotary encoder			
Speed sensor			
Housing			
Cylindrical housing			
Cylindrical housing with flange			
Block housing			
Air purge			

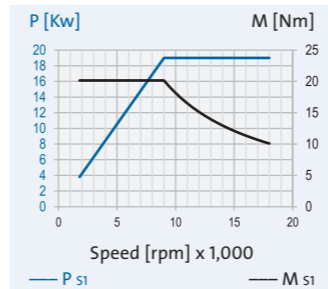

HSP 170g - 15000/19			
170			
15,000			
65			
HSK-C 63			
63			
130			
231			
200 V	350 V	460 V	
500			
200	350	460	
19			
20.2			
9,000			
82	47	36	
22			
21			
10,000			
93	53	40	

Electrical connection			
MAC	MAC	GA	
+	+	+	
o	o	o	
o	o	o	
Coolant through the shaft			
Low pressure (du)			
High pressure (dh)			
Sensor technology			
Rotary encoder			
Speed sensor			
Housing			
Cylindrical housing			
Cylindrical housing with flange			
Block housing			
Air purge			

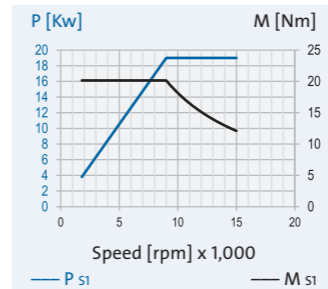

HSP 170g - 12000/20			
170			
12,000			
70			
HSK-C 63			
63			
201			
325			
200 V	350 V	460 V	
400			
200	350	460	
20			
25.5			
7,500			
89	51	39	
23			
29.3			
7,500			
102	58	44	

Electrical connection			
D500	MAC	GA	
+	+	+	
o	o	o	
o	o	o	
Coolant through the shaft			
Low pressure (du)			
High pressure (dh)			
Sensor technology			
Rotary encoder			
Speed sensor			
Housing			
Cylindrical housing			
Cylindrical housing with flange			
Block housing			
Air purge			

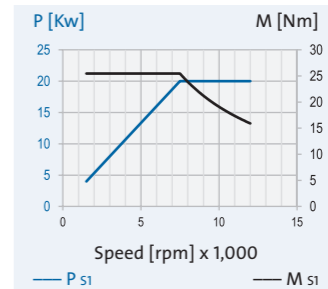

TECHNICAL DATA	
Spindle housing Ø A	[mm]
Speed max. n_{max}	[rpm]
Bearing Ø front W_1	[mm]
Tool interface	
Flat contact face Ø W	[mm]
Static rigidity	
axial C_{ax}	[N/µm]
radial C_{rad}	[N/µm]
Motor design	
Frequency max. f_{max}	[Hz]
Nominal converter voltage ¹⁾ [V]	
Power P_{S1}	[kW]
Torque M_{S1}	[Nm]
... at speed n	[rpm]
Current I_{S1}	[A]
Power $P_{S6-60\%}$	[kW]
Torque $M_{S6-60\%}$	[Nm]
... at speed n	[rpm]
Current $I_{S6-60\%}$	[A]

Electrical connection	
Plug type	
Straight plug-in connection	
Angle plug-in connection	
Fixed cable XXm	
Coolant through the shaft	
Low pressure (du)	
High pressure (dh)	
Sensor technology	
Rotary encoder	
Speed sensor	
Housing	
Cylindrical housing	
Cylindrical housing with flange	
Block housing	
Air purge	

¹⁾ Minimum required output voltage of the frequency converter

- + Standard
- o Option
- x on request

Series: HSP..g

Cylindrical housing:
Ø = 230 mm

Tool interface:
HSK-C

Motor:
Asynchronous motor

Bearing arrangement:
GMN high precision ball bearings

Lubrication:
Permanent grease lubrication

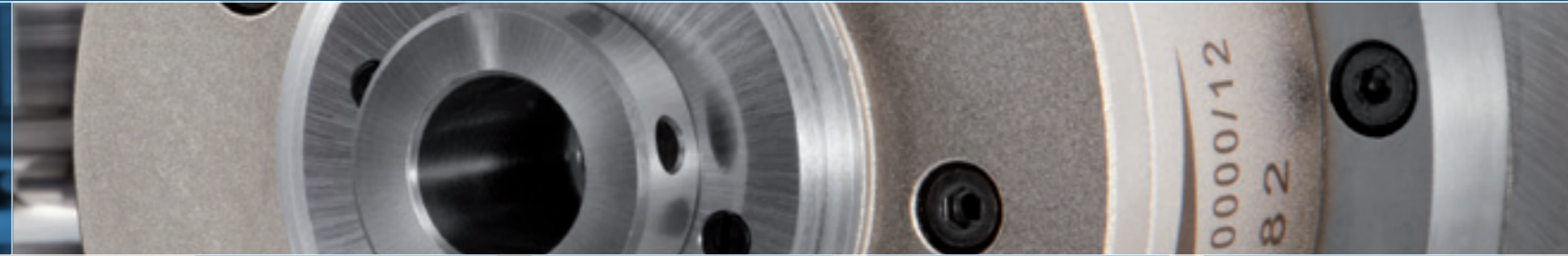

TECHNICAL DATA	
Spindle housing Ø A	[mm]
Speed max. n _{max}	[rpm]
Bearing Ø front W ₁	[mm]
Tool interface	
Flat contact face Ø W	[mm]
Static rigidity	
axial C _{ax}	[N/µm]
radial C _{rad}	[N/µm]
Motor design	
Frequency max. f _{max}	[Hz]
Nominal converter voltage ¹⁾	[V]
Power P _{S1}	[kW]
Torque M _{S1}	[Nm]
... at speed n	[rpm]
Current I _{S1}	[A]
Power P _{S6-60%}	[kW]
Torque M _{S6-60%}	[Nm]
... at speed n	[rpm]
Current I _{S6-60%}	[A]

HSP 230g - 12000/18			
230			
12,000			
70			
HSK-C 63			
63			
196			
375			
200 V	350 V	460 V	
400			
200	350	460	
18			
59.3			
2,900			
100	57	43	
20			
65.9			
2,900			
112	64	49	

HSP 230g - 10000/25			
230			
10,000			
90			
HSK-C 80			
80			
461			
483			
200 V	350 V	460 V	
333			
200	350	460	
25			
85.3			
2,800			
121	69	53	
28			
95.5			
2,800			
187	107	81	

TECHNICAL DATA	
Spindle housing Ø A	[mm]
Speed max. n _{max}	[rpm]
Bearing Ø front W ₁	[mm]
Tool interface	
Flat contact face Ø W	[mm]
Static rigidity	
axial C _{ax}	[N/µm]
radial C _{rad}	[N/µm]
Motor design	
Frequency max. f _{max}	[Hz]
Nominal converter voltage ¹⁾	[V]
Power P _{S1}	[kW]
Torque M _{S1}	[Nm]
... at speed n	[rpm]
Current I _{S1}	[A]
Power P _{S6-60%}	[kW]
Torque M _{S6-60%}	[Nm]
... at speed n	[rpm]
Current I _{S6-60%}	[A]

Electrical connection			
Plug type			
Straight plug-in connection			
Angle plug-in connection			
Fixed cable XXm			
Coolant through the shaft			
Low pressure (du)			
High pressure (dh)			
Sensor technology			
Rotary encoder			
Speed sensor			
Housing			
Cylindrical housing			
Cylindrical housing with flange			
Block housing			
Air purge			

D500	MAC	GA
+	+	+
o	o	o
o	o	o
-		
x		
x		
+		
+		
o		
x		
+		

D500	MAC	MAC
+	+	+
o	o	o
o	o	o
-		
x		
x		
+		
+		
o		
x		
+		

Electrical connection	
Plug type	
Straight plug-in connection	
Angle plug-in connection	
Fixed cable XXm	
Coolant through the shaft	
Low pressure (du)	
High pressure (dh)	
Sensor technology	
Rotary encoder	
Speed sensor	
Housing	
Cylindrical housing	
Cylindrical housing with flange	
Block housing	
Air purge	

¹⁾ Minimum required output voltage of the frequency converter

- + Standard
- o Option
- x on request

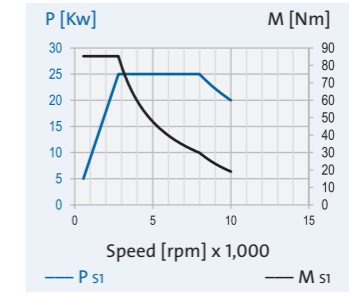
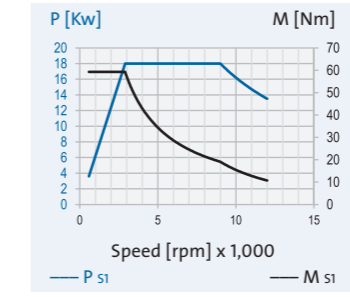

¹⁾ Minimum required output voltage of the frequency converter

- + Standard
- o Option
- x on request

Technical data Features

GMN High speed spindles for manual tool change Dressing spindles

GMN dressing spindles

GMN offers highly effective dressing spindles for precisely shaping and dressing grinding disks.

GMN series TSE dressing spindles are equipped with a permanent grease-lubricated bearing that ensures great running smoothness and offers outstanding rigidity.

With a choice of horizontal or vertical installation orientation as well as optional left or right spindle shaft rotation, GMN dressing spindles can be compactly integrated into existing machine systems.



TECHNICAL DATA		TSE 80 - 10000/1.37	TSE 80cg - 16000/0.85
Spindle housing ϕ	A [mm]	80	80
Speed max.	[rpm]	10,000	16,000
Bearing ϕ front	W ₁ [mm]	35	35
Tool interface			
Flat contact face ϕ	W [mm]	71.8	71.8
Centering diameter		D40h2	D40h2
Static rigidity			
axial	C _{ax} [N/ μ m]	88	89
radial	C _{rad} [N/ μ m]	35	40
Motor design			
Frequency max.	[Hz]	334	533
Converter voltage	[V]	230	230
Power	P _{S2} [kW]	1.37	0.85
Torque	M _{S2} [Nm]	1.31	0.51
... at speed	n [rpm]	10,000	16,000

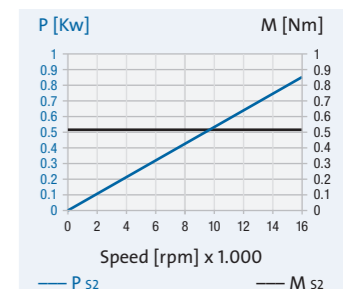
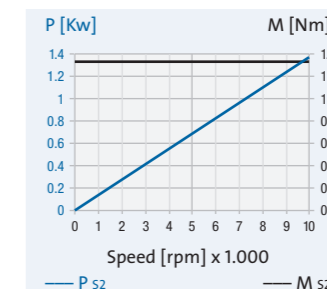

GMN A/E sensor

GMN dressing spindles equipped with an optional acoustic emission sensor improve processing quality and extend the service life of grinding disks.

- Improved tool usage-period
- Reduced maintenance overhead
- High processing accuracy

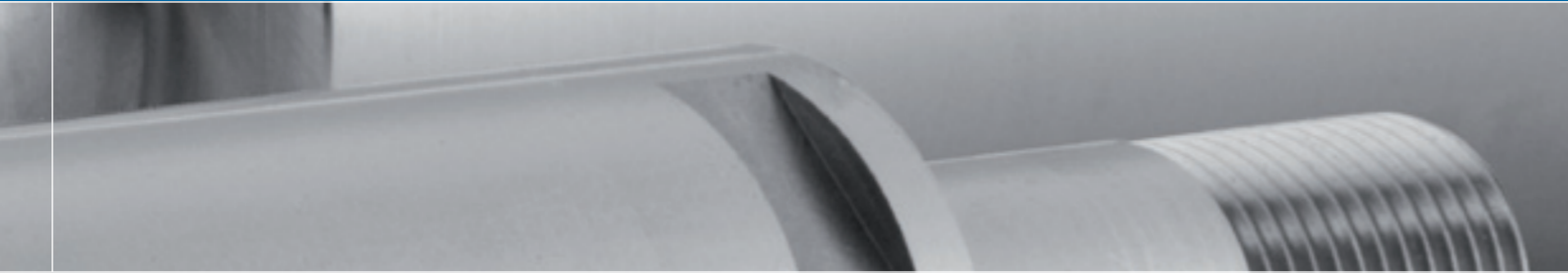

GMN High speed spindles for manual tool change Grinding quills

Grinding quill and grinding wheel dimensions

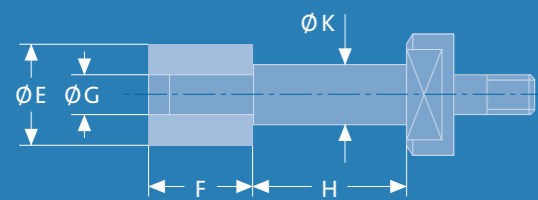

Spindle/grinding quill selection for GMN standard tool interface

GMN spindle		Cutting speed for spindle speed [m/s]													
HS 80c - 180000/...	56														
HS 80c - 150000/...	47														
HSX 80 - 120000/...	38														
HS 80c - 120000/...	38														
HSX 100 - 105000/...		44	55	71											
HS 80c - 90000/...		38	47	61											
HV-X 100 - 105000/...		44	55	71											
HSX 100 - 90000/...		38	47	61	75										
HV-X 100 - 90000/...		38	47	61	75										
HSX 100 - 75000/...			39	51	63	79									
HV-X 100 - 75000/...			39	51	63	79									
HV-X 120 - 75000/...			39	51	63	79									
HSX 100 - 60000/...				41	50	63	79								
HSX 120 - 60000/...				41	50	63	79								
HV-X 100 - 60000/...				41	50	63	79								
HV-X 120 - 60000/...				41	50	63	79								
HSX 120 - 51000/...					43	53	67	85							
HV-X 100 - 45000/...					37	47	59	75							
HSX 120 - 42000/...						44	55	70	88						
HSX 150 - 42000/...						44	55	70	88						
HV-X 120 - 45000/...						47	59	75	94						
HV-X 150 - 45000/...						47	59	75	94						
HV-X 100 - 30000/...							39	50	63	79					
HSX 120 - 30000/...							39	50	63	79					
HV-X 120 - 30000/...							39	50	63	79					
HSX 150 - 30000/...							39	50	63	79	99				
HSX 170 - 30000/...							39	50	63	79	99				
HV-X 150 - 30000/...								50	63	79	99	125			
HSX 150 - 24000/...								40	50	63	79	101			
HSX 170 - 24000/...								40	50	63	79	101			
HSX 150 - 18000/...								30	38	47	59	75			
HSX 170 - 18000/...									38	47	59	75	94		

Grinding wheel dimensions [mm]	E	6	8	10	13	16	20	25	32	40	50	63	80	100
	F	8	10	10	13	16	20	25	25	32	40	40	40	40
	G	2	3	3	4	6	8	10	13	16	20	25	32	36
Grinding disk fixation		KI	KI	KI	PS/PL	PS/PL	PS/PL	PS/PL	PS/PL	MU	MU	MU	MU	MU
see illustrations page 74		1	1	1	2+3	2+3	2+3	2+3	2+3	4	4	4	4	4
Grinding mandrel diameter [mm]	K	4	5	6	8	10	13	16	20	25	32	40	50	56

Grinding mandrel length H [mm]	Grinding quill rigidity [N/µm]														
	16	1.8	4.7	9.8											
20	1	2.4	5	15.8	38.7										
25		1.2	2.6	8.1	19.8	56.5									
32				3.9	9.4	27	61.9	151							
40					4.8	13.8	31.7	77.3	189						
50						7.1	16.2	39.6	96.6	259					
63							3.5	8.1	19.8	48.3	130	317	773	1216	
80											23.6	63.3	155	378	594
100												32.4	79.2	193	304
125													40.5	99	156
160														47.2	74.3

GMN Grinding quills for GMN standard tool interface

Grinding quills

GMN produces grinding quills having high round and flat contact face accuracy for all available GMN standard tool interfaces.

- **GMN quills** for interfaces D14/23 ... D36/68;
Right-hand direction of rotation available at short notice
- Other dimensions and left-hand direction of rotation on request

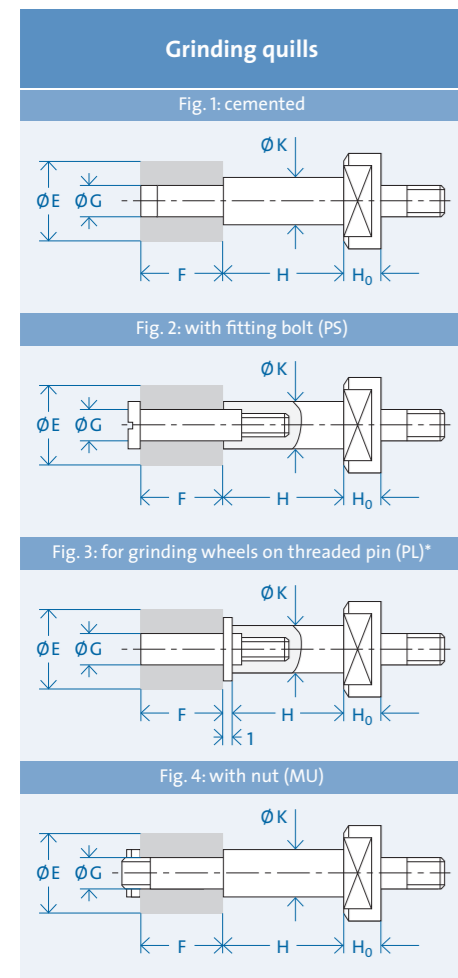

* Fig. 3: Threaded pin not in delivery complement

Interface	K [mm]	H [mm]	Grinding wheel E x F [mm]	G [mm]	Grinding wheel fixation	H ₀ [mm]
D 14/23	6	20	10 x 10	4	KI	8
	10	25	16 x 16	6	PS/PL	
	16	32	25 x 25	10	PS/PL	
D 16/28	10	25	16 x 16	6	PS/PL	10
	13	32	20 x 20	8	PS/PL	
D 22/38	16	40	25 x 25	10	PS/PL	12
	13	32	20 x 20	8	PS/PL	
D 28/43	20	40	32 x 25	13	PS/PL	12
	25	50	40 x 32	16	MU	
D 32/53	20	50	32 x 25	13	PS/PL	12
	32	63	50 x 40	20	MU	
D 36/63	40	80	63 x 40	25	MU	15
	25	50	40 x 32	16	MU	
D 36/68	32	63	50 x 40	20	MU	15
	40	80	63 x 40	25	MU	
	56	125	100 x 40	36	MU	

Fitting hole for fig. 2 and 3

d ₁	M	L ₅	L ₆
4	M3	5	8
6	M5	7	11
8	M6	9	12
10	M8	12	14
13	M12	13	17

Ordering designation:
[quill Ø K] x [quill length H] - [grinding wheel Ø G] x [grinding wheel width F] [interface] [quill fixation]
Example: Grinding quill 16 x 40 - 10 x 25 D16/28 PS

Semifinished products

GMN semifinished products allow individual adaptation of the tool receiver for any type of connection.

- **GMN semifinished products** for interfaces D08/14 ... D36/63;
Right-hand direction of rotation available at short notice
- Other dimensions and left-hand direction of rotation on request

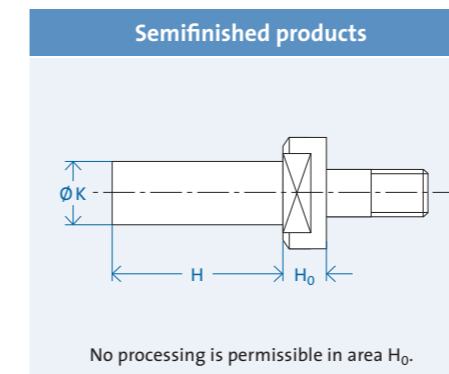

Interface	K [mm]	H [mm]	GMN semifinished products
D 08/14	14	70	
D 09/16	16	84	
D 10/18	18	90	
D 14/23	23	135	
D 16/28	28	229	
D 16/33	33	180	
D 22/38	38	174	
D 28/43	43	240	
D 32/53	53	235	
D 36/63	63	150	

Shrink fit chucks

GMN shrink fit chucks have substantially more clamping force than hydro-expansion or collet chucks and they achieve maximum smooth running at the highest speeds as a consequence of the best possible roundness accuracy.

- **GMN shrink fit chucks** for interfaces D04/08 ... D16/28 and U07/10 ... U16/23;
Right-hand direction of rotation available at short notice
- Other dimensions and left-hand direction of rotation on request

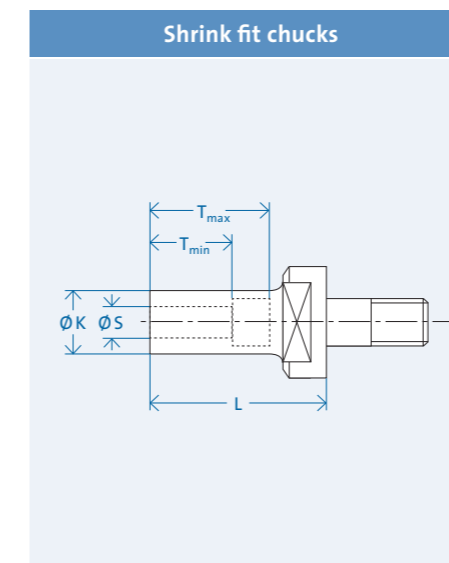

Interface	S [mm]	T _{min} [mm]	T _{max} [mm]	K [mm]	L [mm]	
D 04/08	-	3	10	11	7,5	14
D 06/12	U 07/10	3	10	11	7,5	14
D 08/14	-	3	10	15	7,5	24
D 09/16	U 09/16	3	10	15	7,5	24
D 10/18	-	3	10	15	7,5	24
D 10/18	U 12/18	4	13	21	10	25
D 10/18	U 12/18	5	16	26	11	30
D 10/18	U 12/18	6	19	26	12	30
D 14/23	U 16/23	3	10	15	7,5	24
D 14/23	U 16/23	4	13	21	10	25
D 14/23	U 16/23	5	16	23	11	27
D 14/23	U 16/23	6	19	26	12	30
D 16/28	-	3	10	15	7,5	24
D 16/28	-	4	13	21	10	25
D 16/28	-	5	16	23	11	27
D 16/28	-	6	19	26	12	30

Ordering designation: "Shrink fit chucks" [chucking Ø S] x [max. chucking depth T_{max}] / [chuck length L] [interface]
Example: Shrink fit chucks 6 x 26 / 30 D10/18

GMN Grinding quills for HSK interface

Grinding quills

GMN produces grinding quills having high round and flat contact face accuracy for all available HSK-C interfaces.

- **GMN grinding quills** for interfaces HSK-C25 ... HSK-C100 per DIN 69893-1 are available at short notice
- Other dimensions are available on request

Semifinished products

GMN semifinished products allow individual adaptation of the tool receiver for any type of connection.

- **GMN semifinished products** for interfaces HSK-C25 ... HSK-C100 per DIN 69893-1 are available at short notice
- Other dimensions are available on request

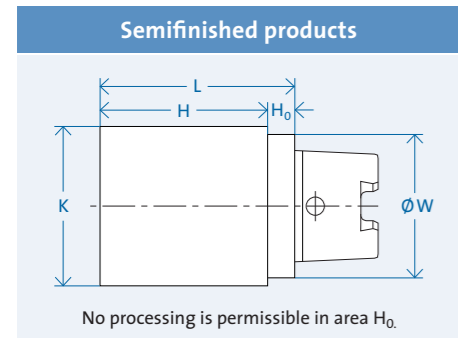

Interface	W [mm]	K [mm]	H [mm]	L [mm]	H ₀ [mm]	Wt. [kg]
HSK-C25	25	30	90	100	10	1
HSK-C32	32	41	139	150	11	1,50
HSK-C40	40	51	169	180	11	2,81
HSK-C50	50	64	186	200	14	4,92
HSK-C50	50	64	76	90	14	2,15
HSK-C63	63	81	186	200	14	7,90
HSK-C63	63	81	86	100	14	3,89
HSK-C80	80	101	193	210	17	12,90
HSK-C100	100	124	208	225	17	21,70

Ordering designation: "Semifinished product" [shaft Ø K] x [shaft length H] [interface]
 Example: Semifinished product 81 x 186 HSK-C63

Shrink fit chucks

GMN shrink fit chucks have substantially more clamping force than hydro-expansion or collet chucks. They achieve maximum smooth running at the highest speeds as a consequence of the best possible roundness accuracy.

- **GMN shrink fit chucks** for interfaces HSK-C25 ... HSK-C40 per DIN 69893-1 are available at short notice
- Other dimensions are available on request

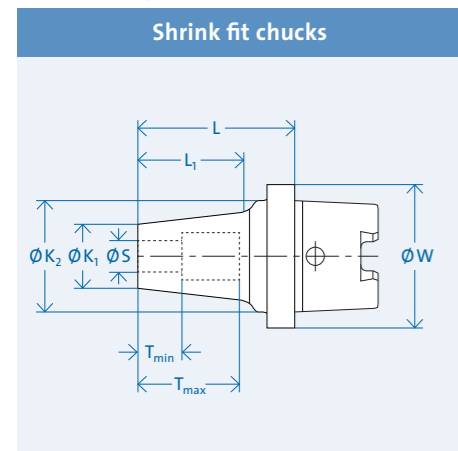

Interface	S [mm]	T _{min} [mm]	T _{max} [mm]	K ₁ [mm]	K ₂ [mm]	L ₁ [mm]	L [mm]	W [mm]
HSK-C25	3	10	27	7,5	18	17	35	25
HSK-C25	4	13	24	10	18	17	35	25
HSK-C25	5	16	25	11	18	17	35	25
HSK-C25	6	19	25	12	18	17	35	25
HSK-C32	3	10	30	7,5	20	22	40	32
HSK-C32	4	13	24	10	20	22	40	32
HSK-C32	5	16	26	11	26	22	40	32
HSK-C32	6	19	28	12	26	22	40	32
HSK-C40	3	10	30	7,5	26	22	40	40
HSK-C40	4	13	30	10	26	22	40	40
HSK-C40	5	16	26	11	26	22	40	40
HSK-C40	6	19	28	12	26	22	40	40

Ordering designation: "Shrink fit chucks" [chucking Ø S] x [max. chucking depth Tmax] / [chuck length L] [interface]
 Example: Shrink fit chucks 6 x 28 / 40 HSK-C32

GMN
 High speed spindles
 for manual tool change
 Accessories

Cables

Spindle/converter connection

For the spindle/converter connection, GMN supplies UL/CSA approved electrical cables suitable for use in drag chains.

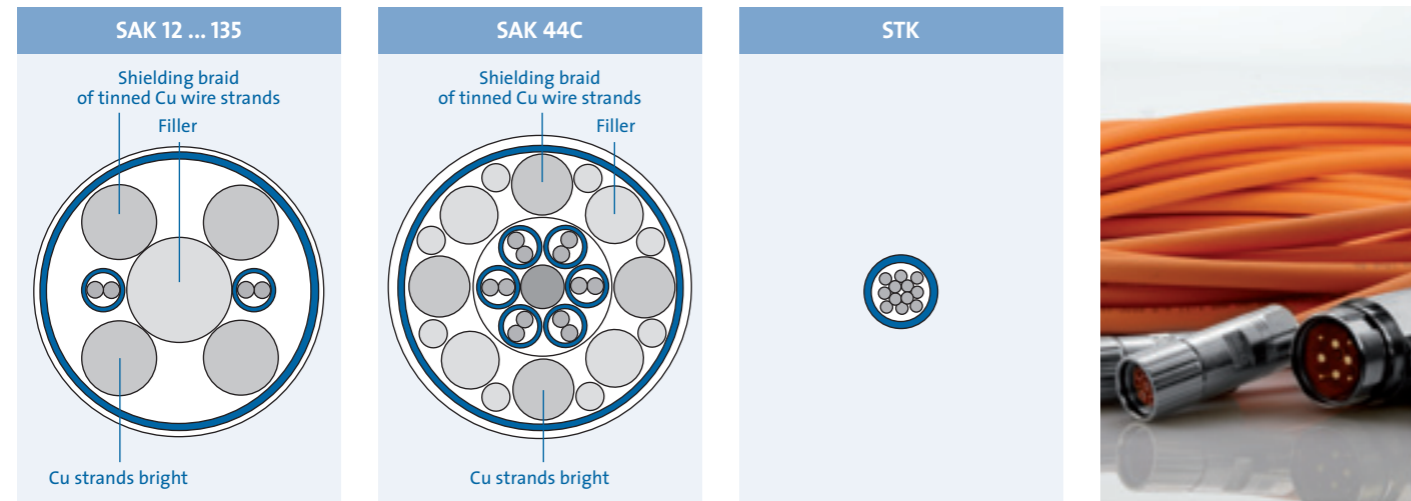

Cable type SAK 12 ... 135

Cable type	Nom. current [A]	Energy transfer Copper strands shielded	Signal transfer Control pair shielded	Jacket Insulation TPE/PUR	Bending radius min. static	Bending radius min. dynamic
SAK 12	12	4 x 0,5 mm ²	2	AD 12,5 mm	5 x AD	10 x AD
SAK 18	18	4 x 1.5 mm ²	3	AD 16 mm	5 x AD	10 x AD
SAK 26	26	4 x 2.5 mm ²	2	AD 16 mm	5 x AD	10 x AD
SAK 34	34	4 x 4 mm ²	2	AD 17 mm	5 x AD	12 x AD
SAK 44	44	4 x 6 mm ²	2	AD 23.8 mm	5 x AD	12 x AD
SAK 44 C	44	4 x 6 mm ²	6	AD 23.8 mm	5 x AD	12 x AD
SAK 61	61	4 x 10 mm ²	2	AD 23.8 mm	5 x AD	12 x AD
SAK 90	90	4 x 16 mm ²	2	AD 32 mm	5 x AD	12 x AD
SAK 108	108	4 x 25 mm ²	2	AD 32 mm	5 x AD	12 x AD
SAK 135	135	4 x 35 mm ²	2	AD 32 mm	5 x AD	12 x AD

Cable type STK abrasion resistant, oil and gasoline resistant

STK			12 x 0,22 mm ²	PUR AD 6.2 mm	5 x AD	20 x AD
-----	--	--	---------------------------	------------------	--------	---------

Conductor lengths must be limited to meet the legally prescribed electromagnetic compatibility requirements. The layout and operation must be in compliance with applicable EMC laws and directives.

Spindle/converter connection

GMN high speed spindles are equipped with plug-in connectors - with flanged socket and plug - which differ according to nominal current (page 20).

Ready-made cables with B048, B049, GA, MAC, D500 and STK plugs are available on request.

Power conductors

B048 plug-in connection: up to 30 A; cable cross section 4 mm²



B049 plug-in connection: up to 30 A; cable cross section 4 mm²



GA plug-in connection: up to 44 A; cable cross section 6 mm²



MAC plug-in connection: up to 100 A; cable cross section 25 mm²



D500 plug-in connection: up to 150 A; cable cross section 50 mm²



Signal lines

STK plug-in connection: Cable cross section 1 mm²



Rotary encoder flanged socket: Cable cross section 1.5 mm²

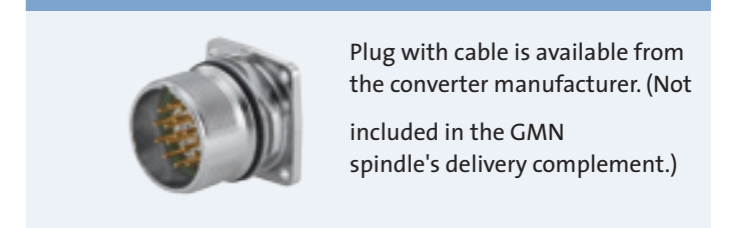

GMN Lubrication units

PRELUB

PRELUB, the electronically controlled lubrication unit, is optimally matched to oil-air lubricated GMN spindles and a guarantor for long service life (page 10).

The precisely regulated dosage of lubricant ensures effective bearing lubrication and maximum operational reliability during start-up and shut-down phases.

With its 4 connections (maximum), this lubrication unit is capable of simultaneously providing individual supplies to a maximum of 2 spindles while requiring only a minimum amount of space.

Connection to a conventional PC computer supports clearly comprehensible operation with a multi-lingual menu structure.

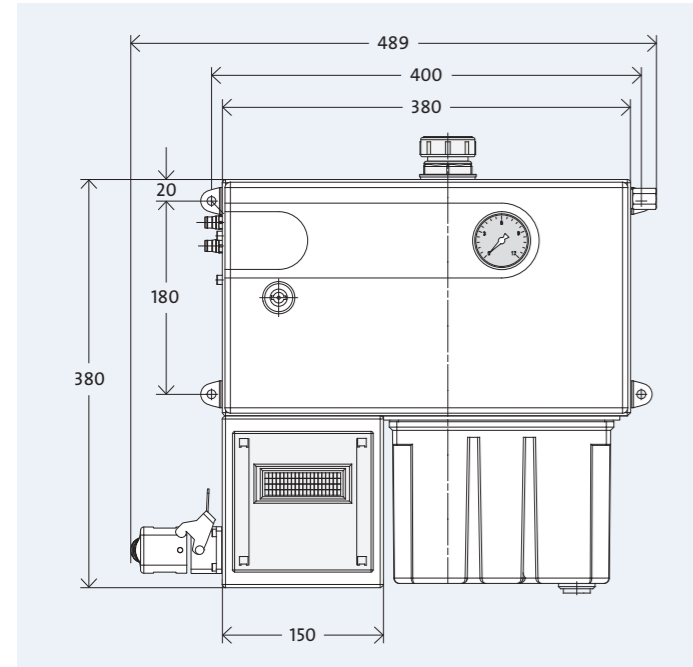

PRELUB GP

- Up to 4 internal or external (GP 0: e.g. 1 x 4-fold mixing distributors) lubrication point connections

- Separate evaluation of fill-level

- Electronic control with display

- Very convenient to operate

- Menu languages: DE, ENG, ES, FR, IT, JP, CN

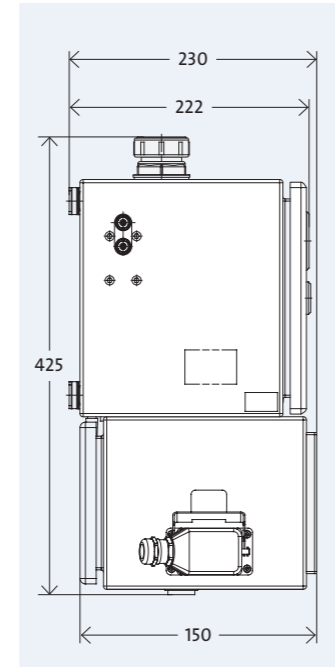

Device types

PRELUB GP 2 (standard)
2 lubrication point connections

PRELUB GP 4
4 lubrication point connections

PRELUB GP 0
for external mixing distributors
(max. 4 lubrication point connections)

Features

- Compressed air filter/regulator with manometer: Filter unit, 5 μ m

- Enable signal for the machine controller following checks on:

- Oil level
- Oil pressure rise and drop
- Air pressure
- Pre-lub cycle

- Timer:

for adapting the cycle time to oil viscosity and spindle data

- Lubrication point connections:

for PVC pipe 6 x 1

- Line voltage:

90 ... 260 V AC, 50/60 Hz

- Air supply G1/4":

$p_{min} = 5$ bar, $p_{max} = 10$ bar

- Plug-in connection for power and signal transfers

- Dimensions:

about 484 x 432 x 222 mm (W x H x D);
Protection class IP 55

- Color:

RAL 7032 textured (pebble gray);
other colors on request

- Max. fuse protection:

6 A

Accessories

Accessory parts necessary for assembly, e.g. lubrication hoses, hydraulic and compressed air hoses, monitor manometer and filtered lubrication oil, are available from GMN.

Pre-lubrication

Automatic time lapse

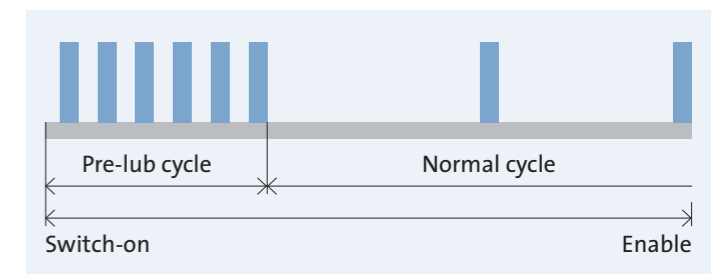

- Start pre-lubrication (enable signal to operate the spindle not issued)
- Multiple lubrication pulses within short time, depending on the length of line between spindle and mixing distributor (pre-lub cycle)
- Enable signal following expiration of the pre-lub time
- Transition to normal cycle (cycle time) according to GMN operating instructions

The length of the pre-lub period depends on the length of connected lubrication lines.

(For details: see operating instructions)

Maintenance

Filtration of the oil and air supplies are necessary to ensure the unit provides a long-term, consistent lubricating function. The cartridges intended for a routine maintenance filter change are available from GMN.

Lubricant selection

The use of filtered oils with friction and wear reducing additives ensures long-term reliable operation of the spindle at maximum speeds.

Detailed specifications for the necessary lubricants as well as rules for cycle times and lubrication pressures are provided in the operating instructions included in the delivery complement.

GMN Cooling units

Coolant supply

Reducing the heat caused by operation and obtaining maximum spindle performance depend on a reliable supply of coolant in the necessary quantity and at the proper temperature (page 11).

GMN cooling units ensure the precise coolant temperature and volume regulation necessary to obtain constant low operating temperatures.

Highly precise regulation accuracy reduces axial shaft elongations caused by temperature fluctuations of the coolant.

- **Coolant:**
R407c (FCKW free)
- **Coolant temperature:**
20 °C – 25 °C
- **Regulation accuracy:**
 - Model T: ± 2 °K
 - Model F: ± 1 °K
- **High-precision regulation accuracy (on request):**
(for minimal axial spindle shaft elongation)
 - Model T: ± 1.2 °K
 - Model F: ± 0.5 °K
- **Permissible ambient temperature:**
+ 42 °C
- **Connections for multiple spindles (on request)**
(parallel or series connection)
- **Coolant sensor:**
Level and flow volume monitoring with fault alert contact
- **Color:**
 - Model F: RAL 5019 (capri blue)
 - Model T: RAL 9005 (deep black)
 - Other RAL colors (on request)



Cooling unit model	Cooling perform. ²⁾ [kW]	for spindle power [kW]		Tank capacity [l]	Supply voltage ³⁾	Dimensions L x W x H [mm]
		S6-60%	S1			
K 0.9-T/3	0.9	6	4.5	6.4	1 x 230 V, 50 Hz	560 x 475 x 355
K 1.4-T/3	1.4	9	7	20	1 x 230 V, 50 Hz	710 x 545 x 450
K 2.5-T/3	2.5	16.5	12.5	20	1 x 230 V, 50 Hz	710 x 545 x 450
K 3.9-T/3	3.9	26	19.5	26	1 x 230 V, 50 Hz	760 x 610 x 500
K 5.3-T/3	5.3	35	26.5	26	1 x 230 V, 50 Hz	760 x 610 x 500
K 4.1-F ¹⁾	4.1	27	20.5	120	3 x 400 V, 50 Hz	715 x 715 x 1545
K 6.7-F ¹⁾	6.7	44.5	33.5	120	3 x 400 V, 50 Hz	715 x 715 x 1545
K 7.9-F ¹⁾	7.9	52.5	39.5	120	3 x 400 V, 50 Hz	715 x 715 x 1545
K 11.8-F ¹⁾	11.8	98.5 ⁴⁾	59	120	3 x 400 V, 50 Hz	715 x 715 x 1545

¹⁾ In addition to high pressure monitoring, also low pressure monitoring of the coolant circuit.

²⁾ At 37 °C ambient temperature and 20 °C water temperature. Performance drops at higher ambient temperatures.

³⁾ Other voltages and frequencies possible on request.

⁴⁾ Assumption: Spindle power ≥ 80 kW leads to reduced cooling efficiency from 12% respectively 10% in relation to the spindle power.

GMN
High speed spindles
for manual tool change
Service

Service

GMN Spindle service

On the basis of long experience in the practical application of machine components, GMN provides comprehensive consultation and competent services in the field of spindle technology in order to support successful design and long-term economic operation of machine systems.

GMN's service network, available around the world and through authorized GMN affiliates, assures quick, professional, on-site services.

Consultation

GMN is able to support its customers with technically-oriented knowhow and comprehensive expertise during the planning phase of machine systems as well as in the necessary selection of spindles.

- Analysis of performance requirements
- Spindle selection, service life calculation, characteristic values, installation dimensions ...
- Interfaces, tool selection, grinding mandrels
- Recoding of competitive products
- Special solutions
- Cooling units, lubrication units

Assembly

Upon customer request, GMN will provide GMN professionals to support the commissioning of spindles and spindle systems – in foreign countries this support can be provided by authorized affiliates.

- Inspection of setup data on lubrication and cooling systems
- Availability of necessary accessory products
- Conducting tests for spindle operation (test protocol)

Spindle analysis

In the event of degraded spindle functionality or the occurrence of reduced processing quality, GMN offers comprehensive testing techniques which allow the causes of problems to be determined.

- Spindle bearing noise testing (bearing frequencies)
- Microscopic and measured bearing inspection
- Lubricant investigation
- Calculation review (e.g. check of preload)
- Weak-point analysis

Repair

The sophisticated spindle analysis results and the availability of special technical facilities enable reliable repair solutions to be identified.

- Investigation of causes for spindle damage or inadequate processing results
- Repair
- Prevention of identical or similar damage
- Spindle optimization with respect to processing requirements

Training courses

GMN provides qualified training courses in theory and practice for high frequency spindles and their applications, both at customer locations and also on our premises.

Subjects and contents of training courses are focused on individual customer requirements.

- Essentials: products, designs, materials, accuracies and tolerances
- Engineering: nomenclature, spindle selection, spindle installation, preload, matching, lubrication, calculation
- Maintenance: workplace layout, tools, control measurements, lubrication, installation, grease distribution run

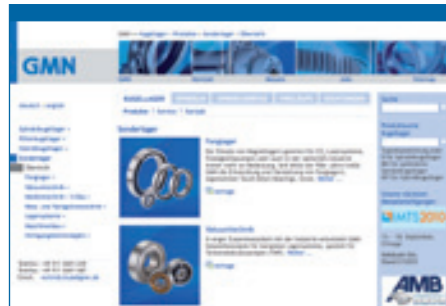

Internet

Our Internet website www.gmn.de contains comprehensive product information for downloading.

GMN

GMN Paul Müller Industrie GmbH & Co. KG manufactures high precision ball bearings, machine spindles, freewheel clutches and seals for a broad spectrum of applications at its Nuremberg, Germany plant.

Based on many years of experience in the development and production of machine components, GMN specializes in the production of high quality products in the field of spindle technology and is therefore not only able to offer an extensive standard program but also customer-oriented special solutions.

A world-wide GMN service network offers competent customer advice as well as individual solutions.



GMN quality management – audited and awarded.

GMN guarantees the highest quality products and services based on long-term reliability. Modern development and production processes ensure products are always at the leading edge of state-of-the-art engineering.

The transparent structure of all GMN company divisions and the clarity of organization flows ensure customer-oriented services and economic security.

All GMN company divisions are certified to DIN ISO 9001:2008.



GMN – safeguarding the future.

At GMN, progress means the best possible customer support and the performance optimization of technical products.

This aspiration is turned into reality at GMN, particularly by conforming to national and international environmental standards for efficient and responsible use of ecological resources.



GMN

- High Precision Ball Bearings
- Spindle Technology
- Sprag Type Freewheel Clutches
- Non Contact Seals