



AUTOMATIONBOOK

Your ifm customer no.





<i>ifm – the company</i>	6 - 7	
<i>General information</i>	8 - 11	
<i>Standards and approvals / list of articles</i>	12 - 63	
<i>Sensors for special applications</i>	64 - 67	
<i>Position sensors</i>	68 - 341	
<i>Sensors for motion control</i>	342 - 379	
<i>Industrial imaging</i>	380 - 400	
<i>Safety technology</i>	402 - 445	
<i>Process sensors</i>	446 - 599	
<i>Industrial communication</i>	600 - 656	
<i>Identification systems</i>	658 - 683	
<i>Condition monitoring systems</i>	684 - 694	
<i>Systems for mobile machines</i>	696 - 751	
<i>Connection technology</i>	752 - 860	
<i>Power supplies</i>	862 - 872	
<i>ifm – worldwide addresses</i>	874 - 877	

ifm – the company matching your requirements

close to you:

Our worldwide sales and service team is here to help you at any time.

Engineering „Made in Germany“:

German engineering available worldwide.

Flexible:

Not only our service but our broad product portfolio perfectly suit the most varying requirements.

Innovative:

More than 750 patents and in 2016 about 60 patent applications.

Reliable:

5-year warranty on ifm products.



System instead of just components
ifm provides you with a broad portfolio for flexible automation of your production.

Our range of more than 7,800 articles guarantees flexibility and compatibility.



Quality as part of our philosophy

Quality is an inherent part of our philosophy.

We use our customers' feedback to continuously improve the quality of our products.

Our sensors are tested with values far beyond the indicated limits using special procedures.

We are there for you

Close contact with our customers is part of our success. We have consistently developed our sales network right from the start.

Today the ifm group of companies is represented in more than 70 countries – according to the motto “ifm – close to you!” Your personal application support and service are at the heart of our operation.

For the introduction of new products and technologies we support you with workshops and seminars in our training centres or in your plant.

Security by success

Since its foundation in 1969 ifm electronic has constantly grown, now having more than 6500 employees worldwide, and achieved a turnover of over EUR 810 million in 2016. This success gives you the security of having a reliable partner for the implementation of your automation projects. Comprehensive service and a warranty of up to 5 years on standard units are just two examples in this context.

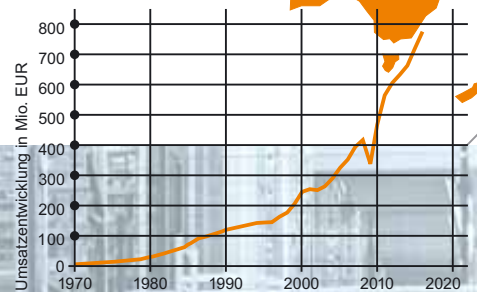
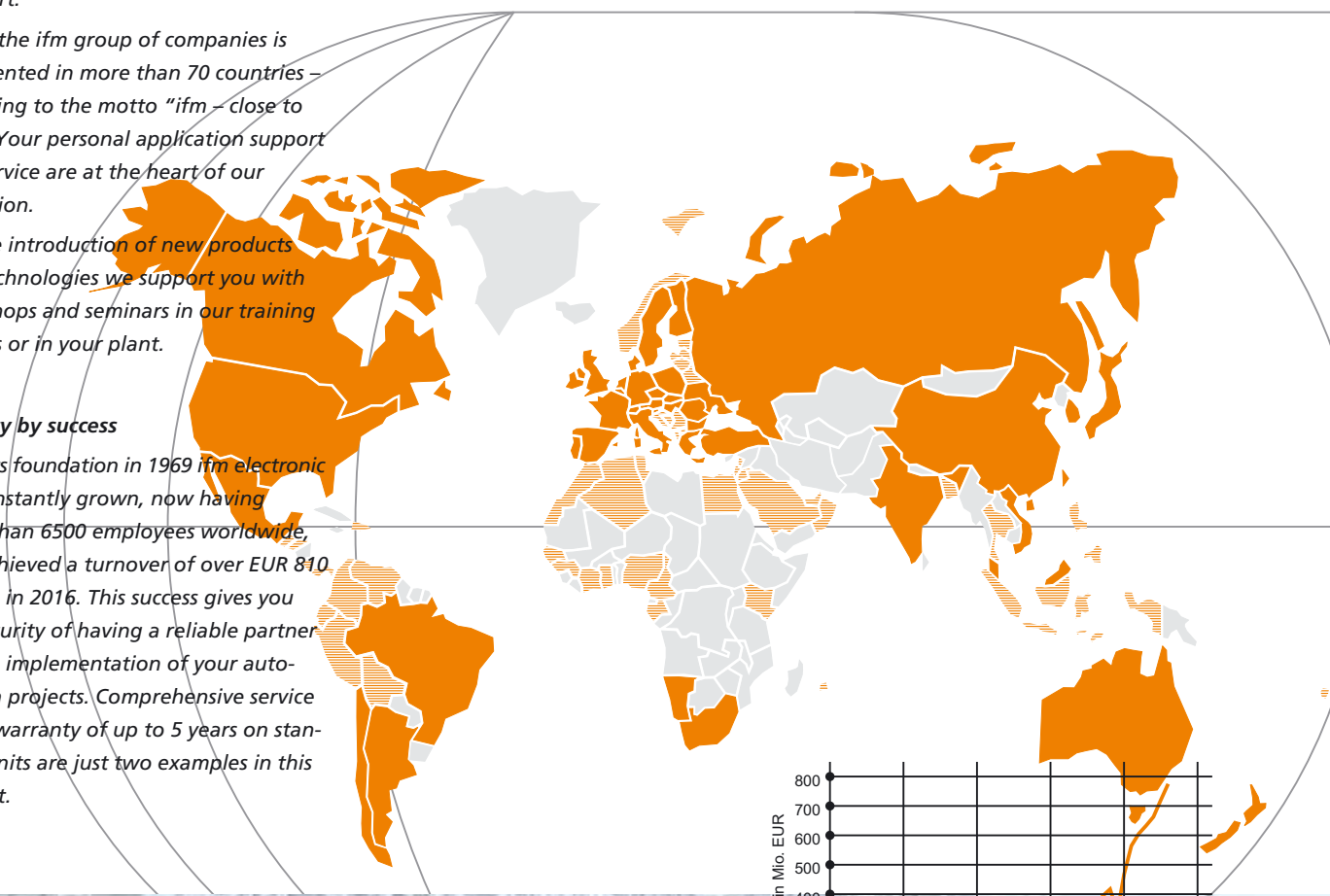

Product availability
 Your deadlines matter to us. That is why we are constantly optimising our production processes. In order to be able to quickly and flexibly produce large quantities at a constantly high quality – and to continue to shorten delivery times.

See the current ifm company film to get to know us better:
www.ifm.com/gb/close-to-you



The ifm sales platform



Overview:

The ifm product range is clearly structured and the individual product platforms ensure quick orientation.

Selectors:

Choose between the most important technical data and you will get the product selection suitable for your requirements.

Compare:

You can compare the technical data of up to 3 products. Differences are marked in colour.

Search and find:

Enter the search term in the full text search and get suggestions for products, topics and product groups.

Order:

We provide a quick-order and csv import function for the shopping basket on the product pages.



More clarity

For each product group you can make a first selection via the platforms.

A clear visual language and explanatory texts give you a first impression of the products.



Compare products with each other

The selectors are the heart of the product search.

The displayed selection criteria are adapted to each product range and the technical features of the products.

The results can be displayed as tiles or lists.

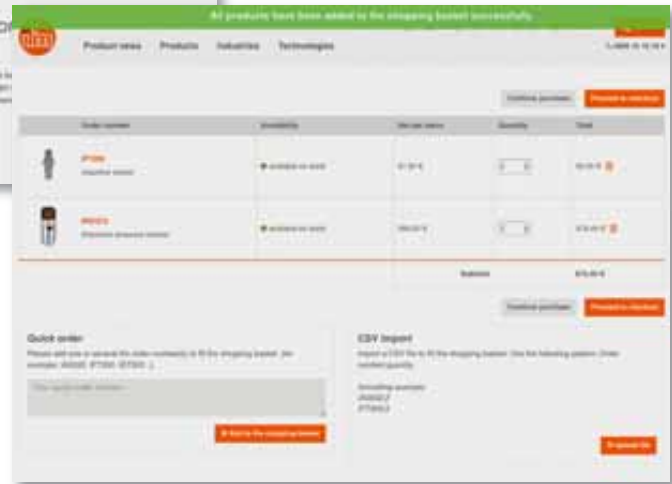

Easy purchasing

You are in control of everything in the shopping basket: quantity, modes of shipment and payment. We provide you with everything you can expect from a modern shop.

Customers relying on long-standing tried-and-tested articles can quickly order by entering the article number in the shopping basket. This saves time, in particular when a product has to be quickly reordered.

Navigation in the menu structure is no longer necessary.



For all types of display

Whether PC, laptop, tablet or smart-phone – the design of the sales platform adapts to any screen size thus increasing user-friendliness. This also makes it possible to buy products using mobile equipment such as a smartphone.

Try us. Click here to directly get to our homepage:
www.ifm.com



Your start into the industrial revolution. IO-Link solutions from ifm.



Simple:

The sensor parameters can be set from the controller or the master. No crawling or climbing required to set the sensor.

Transparent:

Many sensors supply measured values to the switching signals via IO-Link. The goal is a constant product quality with less energy and raw material consumption.

Reliable:

Transmission that is prone to errors and conversion of analogue signals is replaced with digital measured value transmission.

Low-cost:

Process information, switching status, diagnostic functions are transmitted without loss via a single port to the controller. Expensive analogue signal processing is no longer needed.

Fascination IO-Link

In the past binary switches usually provided simple switching signals or analogue values. Today the data from intelligent sensors is the basis for the next industrial revolution.

Sensors that extract all the information from your machines and equipment using the key technology IO-Link.

Leading manufacturers from the fields of sensors, actuators and control technology have developed IO-Link.

Together they developed a standardised and field-bus independent interface for automation providing the user with a point-to-point connection without complex addressing.

Benefit from the appeal of IO-Link, talk to us and stay as productive and competitive for your manufacturing processes of tomorrow.



Head start with IO-Link

Use the advantages! Today IO-Link sensors from ifm give the user completely new options.

Additional sensor data, for example, is generated to achieve maximum efficiency and cost saving.

This allows process transparency from the machine to ERP to optimise your existing automation. Furthermore IO-Link has a lot more to offer:



No external influence of the signal
Data transfer is based on a 24 V signal. Screened cables and associated grounding are no longer necessary.



Tamper free
No wrong settings by operators.



No measured value losses
The entire measured value transmission is digital. Transmission that is prone to errors and conversion of analogue signals is replaced.



Identification
Only like for like replacement.
No wrong sensors accepted.



Easy sensor replacement
All sensor parameters are stored in the master and transferred to the replaced unit.



Wire-break detection / diagnostics
Wire-break or short-circuit is immediately detected.



Point-to-point communication: more details in our IO-Link video:
www.io-link.ifm



3A



3A Sanitary Standards, Inc. (3-A SSI) is an independent, not-for-profit corporation dedicated to advancing hygienic equipment design for the food, beverage, and pharmaceutical industries.

AS-i



Actuator-Sensor Interface. Bus system for the first binary field level.

ATEX



Atmosphère Explosible. ATEX comprises the directives of the European Union in the field of explosion protection. On the one hand there is the 94/9/EC ATEX product directive and on the other hand the 1999/92/EC ATEX operation directive.

CCC



CCC (China Compulsory Certification) is a compulsory Chinese certification for certain products put on the market in China. Which products are concerned is specified in a catalogue created by the Chinese authorities.

cCSAus



Testing of a product by CSA according to the safety standards applicable in Canada and the USA.

CE



Conformité Européenne. By affixing the CE marking to a product, the manufacturer declares that it meets EU safety, health and environmental requirements.

cRUus



Testing of components by UL according to the safety standards applicable in Canada and the USA. Components can be used when the "condition of acceptability" is complied with for the final product.

CSA



Canadian Standards Association. A non-governmental Canadian organisation that sets standards and tests and certifies products for their reliability. By now it is active worldwide.

cULus



Testing of components by UL according to the safety standards applicable in Canada and the USA.

DIBt (WHG)



Deutsches Institut für Bautechnik (Federal Water Act). The Federal Water Act (WHG) is the essential part of the German law relating to water. It contains provisions for the protection and use of surface water and ground water and also regulations about the expansion of waters, water planning and flood protection.

DKD



The Deutscher Kalibrierdienst (DKD) is an association of calibration laboratories of industrial firms, research institutes, technical authorities, inspection and testing institutes. The DKD calibration certificates prove traceability to national standards as required in ISO 9000 and ISO / IEC 17025. They also serve as a metrological basis for the control of measurement and test equipment within the framework of quality management.

E1



Approval by the Kraftfahrt-Bundesamt (German Federal Motor Transport Authority). The E1 type approval by the German Federal Motor Transport Authority certifies that the units comply with the automotive standards. Units with this marking are allowed to be mounted on vehicles without expiry of their operating permit.

EG 1935/2004

The Regulation EC 1935/2004 has been taken into account for process sensors from ifm which are intended for use in contact with food. You can obtain a list of the corresponding products and detailed information on request.

EHEDG



European Hygienic Engineering & Design Group. European supervisory authority for food and drugs. This authority grants approvals for products and materials used in the food and pharmaceutical industries.

FDA



Food and Drug Administration. US-American supervisory authority for food and drugs. This authority grants approvals for products and materials used in the food and pharmaceutical industries.

FM



Factory Mutual Research. A US-based insurance company that specializes in loss prevention services in the property insurance market sector. They provide material research, material testing and certifications in the field of fire and explosion protection.

PROFIBUS



Process Field Bus. Fieldbus system for important data quantities. It is available in several versions such as Profibus FMS, DP or PA. Profibus DP can be used over longer distances, e.g. as fieldbus for AS-i.

TÜV



Technischer Überwachungs Verein (technical inspection association). The German TÜV is a private-sector body carrying out technical safety tests that are stipulated by government laws or instructions.

UL



Underwriters Laboratories. An organisation founded in the USA for testing and certifying products and their safety.

Standards and approvals / list of articles

Order no.	Approvals	Catalogue page	Order no.	Approvals	Catalogue page
AC0017	CE	330, 591	AC1422	CE, CUL, EAC	603
AC0019	CE	330, 591	AC1423	CE, CUL	604
AC0015	CE, CUL	440, 644	AC1424	CE, CUL	604
AC0020	CE	330, 591	AC1433	CE, CUL	604
AC0021	CE	330, 592	AC1434	CE, CUL	604
AC0022	CE	330, 592	AC2032	CE	618
AC0023	CE	330, 592	AC2035	CE, CUL, EAC	618
AC0025	CE, CUL	440, 644	AC2055	CE, CUL	632
AC0035	CE, CUL	440, 644	AC2057	CE	632
AC0045	CE, CUL	440, 644	AC2086	CE	614
AC0095	CE, CRUUS	440, 644	AC2088	CE	614
AC0105	CE, CUL	441, 645	AC2211	CE	608
AC0115		442, 604	AC2212	CE	608
AC0116		442, 604	AC2250	CE, CRUUS, EAC	610
AC0115	CE, CUL	441, 645	AC2251	CE, CRUUS, EAC	611
AC0125	CE, CUL	441, 645	AC2252	CE, CRUUS, EAC	610
AC0155	CE, CRUUS	441, 645	AC2254	CE, CRUUS, EAC	610
AC0305	CE, CUL	440, 644	AC2255	CE, CRUUS, EAC	610
AC0325	CE, CUL	440, 644	AC2256	CE, CRUUS, EAC	610
AC0415	CE, CUL, TÜV Nord	440, 644	AC2257	CE, CRUUS, EAC	611
AC1145	CE	642	AC2258	CE, CRUUS, EAC	611
AC1146	CE, CUL	642	AC2259	CE, CRUUS, EAC	611
AC1147	CE, CUL	642	AC2264	CE, CRUUS, EAC	611
AC1154	CE	622	AC2267	CE, CRUUS, EAC	611
AC1221	CE, CRUUS, CUL	870	AC2310	CE, CUL	638
AC1250	CE, CRUUS, EAC	603	AC2315	CE, CUL	327, 589
AC1253	CE, CRUUS, CUL	608, 871	AC2316	CE, CUL	327, 589
AC1254	CE, CRUUS, CUL	608, 870	AC2317	CE, CUL	327, 589
AC1256	CE, CRUUS, CUL	608, 870	AC2402	CE, CUL	616
AC1257	CE, CUL	608, 871	AC2403	CE, CUL	616
AC1258	CE, CRUUS, CUL	608, 870	AC2410	CE, CUL	616
AC1318	CE, CUL, EAC	602	AC2411	CE, CUL	616
AC1324	CE, CUL, EAC	602	AC2412	CE, CUL	616
AC1331	CE, CUL, EAC	602	AC2413	CE, CUL	616
AC1332	CE, CUL, EAC	602	AC2417	CE, CUL	616
AC1355	CE, CUL, EAC	602	AC2451	CE, CUL	616
AC1356	CE, CUL, EAC	602	AC2452	CE, CUL	617
AC1357	CE, CUL, EAC	602	AC2453	CE, CUL	617
AC1358	CE, CUL, EAC	603	AC2454	CE, CUL	617
AC1365	CE, CUL, EAC	602	AC2455	CE, CUL	617
AC1366	CE, CUL, EAC	602	AC2456	CE, CUL	617
AC1375	CE, CUL, EAC	603	AC2457	CE, CUL	616
AC1376	CE, CUL, EAC	603	AC2458	CE, CUL	616
AC1401	CE, CUL, Profinet, EAC	603	AC2459	CE, CUL	616
AC1402	CE, CUL, Profinet, EAC	603	AC2464	CE, CUL	617
AC1403	CE, CUL, Profinet	604	AC2465	CE, CUL	617
AC1404	CE, CUL, Profinet	604	AC2466	CE, CUL	617
AC1411	CE, CUL, EAC, PI	603	AC246A	CE	631
AC1412	CE, CUL, EAC, PI	603	AC2471	CE, CUL	617
AC1421	CE, CUL, EAC	603	AC2482	CE, CUL	617

Order no.	Approvals	Catalogue page
AC2484	CE, CUL	617
AC2485	CE, CUL	618
AC2486	CE, CUL	618
AC2487	CE, CUL	618
AC2488	CE, CUL	617
AC2516	CE, CUL	614
AC2517	CE, CUL	614
AC2616	CE	618
AC2617	CE	618
AC2618	CE	618
AC2619	CE	618
AC2620	CE	618
AC2709	CE, CRUUS, EAC	611
AC2729	CE, CRUUS, EAC	611
AC2731	CE	611
AC2739	CE, CRUUS	611
AC2750	CE, CRUUS, EAC	611
AC2751	CE, CRUUS, EAC	611
AC2752	CE, CRUUS, EAC	611
AC2753	CE, CRUUS, EAC	611
AC2900	CE, CUL, EAC	619
AC2904	CE, CUL, EAC	618
AC2910	CE, CUL, EAC	619
AC2916	CE, CUL, EAC	619
AC2923	CE, CUL	619
AC3000		623
AC3200	CE, CUL, EAC	611
AC3201	CE, CUL, EAC	611
AC3202	CE, CUL, EAC	611
AC3203	CE, CUL, EAC	612
AC3204	CE, CUL, EAC	612
AC3216	CE	612
AC3217	CE	612
AC3218	CE	612
AC3219	CE	612
AC3220	CE, CUL, EAC	612
AC3221	CE, CUL, EAC	612
AC3222	CE	612
AC3225	CE	642
AC326A	CE, (CCC)	329, 590
AC327A	CE	328, 638
AC336A	CE	328, 638
AC402S	CE, CUL, EAC, Profinet	645
AC412S	CE, CUL, EAC, PI	645
AC422S	CE, CUL	645
AC5000	CUL	619
AC5003	CUL	619
AC5005	CUL	621
AC5007		623
AC5010	CUL	619

Order no.	Approvals	Catalogue page
AC5011	CUL	619
AC5014	CUL	619
AC5015		619
AC505A	CE	615
AC505S	CE, CUL, EAC	440, 644
AC506S	CE, CUL, EAC	441, 645
AC507A	CE	615
AC507S	CE, CUL, EAC	441, 645
AC508A	CE	615
AC509S	CE, CUL, EAC	441, 645
AC514A	CE	615
AC515A	CE	615
AC5200	CE, CUL, EAC	612
AC5203	CE, CUL, EAC	613
AC5204	CE, CUL, EAC	613
AC5205	CE, CUL, EAC	612
AC5208	CE, CUL, EAC	613
AC5209	CE, CUL, EAC	613
AC5210	CE, CUL, EAC	613
AC5211	CE, CUL, EAC	613
AC5212	CE, CUL, EAC	613
AC5213	CE, CUL, EAC	613
AC5214	CE, CUL, EAC	613
AC5215	CE, CUL, EAC	612
AC5216	CE, CUL, EAC	612
AC5218	CE, CUL, EAC	614
AC5222	CE, CUL, EAC	614
AC5223	CE, CUL, EAC	614
AC5224	CE, CUL, EAC	613
AC5225	CE, CUL, EAC	615
AC5226	CE, CUL, EAC	615
AC5227	CE, CUL, EAC	630
AC5228	CE, CUL, EAC	630
AC522A	CE	615
AC5230	CE, CUL, EAC	615
AC5234	CE, CUL, EAC	614
AC5235	CE, CUL, EAC	613
AC5236	CE, CUL, EAC	614
AC5243	CE, CUL, EAC	630
AC5245	CE, CUL, EAC	614
AC5246	CE, CUL, EAC	630
AC5249	CE, CUL, EAC	630
AC5251	CE, CUL, EAC	630
AC5253	CE, CUL, EAC	631
AC5270	CE, CUL, EAC	631
AC5271	CE, CUL, EAC	631
AC5275	CE, CUL, EAC	614
AC528A	CE	631
AC5292	CE, CUL, EAC	613
AC5293	CE, CUL, EAC	614

**Standards and approvals /
list of articles**

Order no.	Approvals	Catalogue page	Order no.	Approvals	Catalogue page
AC535A	CE	615	AP3052		654
AC542A	CE	631	AP3062		654
AC546A	CE	631	AY1000	CE, CUL, Profinet	653
AC551A	CE	631	AY1020	CE, CUL	653
AC570A	CE	631	CP9006		438, 702
AC901S	CE, CUL	441, 645	CP9008		438, 702
AC902S	CE, CUL	441, 646	CP9030		707
AC903S	CE, CUL	441, 646	CP9031		707
AC904S	CE, CUL	441, 646	CP9200		707
AL1000	CE, CUL	653	CP9201		707
AL1010	CE, CUL, PI	653	CR0032	CE, E1R	705
AL1020	CE, CUL	653	CR0033	CE, E1R, EAC	705
AL1030	CE, CUL	653	CR0053	E1R	705
AL1100	CE, CUL, Profinet	652	CR0063		706
AL1101	CE, Profinet	652	CR0133	CE, E1R, EAC	705
AL1102	CE, Profinet	653	CR0153	E1R	705
AL1103	CE, Profinet	652	CR0163		706
AL1120	CE	652	CR0234	CE, E1R	705
AL1121	CE	652	CR0235	CE, E1R	705
AL1122	CE	653	CR0253	E1R	706
AL1123	CE	652	CR0263		706
AL1200	CE, Profinet	652	CR0303	CE, E1R, EAC	706
AL1202	CE, Profinet	653	CR0401	CE, E1R, EAC	698
AL1220	CE	652	CR0403	CE, CUL, E1R, EAC	698
AL1222	CE	653	CR0411	CE, E1R, EAC	698
AL2230	CE	652	CR0421	CE, EAC	699
AL2330	CE	653	CR0431	CE, E1R, EAC	698
AL2400	CE, CUL	653	CR0451	CE, E1R, EAC	693, 699
AL2401	CE, CUL	653	CR0452	CE, E1R, EAC	671, 699
ANT410	CE, CUL	667	CR711S	CE	704
ANT411	CE, CUL	668	CR1080	CE, E1R	718
ANT420	CE, CUL	668	CR1081	CE, E1R	718
ANT421	CE, CUL	668	CR1082	CE, E1R	718
ANT430	CE, CUL	668	CR1083	CE, E1R	718
ANT431	CE, CUL	668	CR1084	CE, E1R	719
ANT512	CE, CUL	663	CR1085	CE, E1R	719
ANT513	CE, CUL	668	CR1087	CE, E1R	718
ANT515	CE, CUL, (CCC)	668	CR1200	CE, E1R	719
ANT516	CE, CUL, (CCC)	668	CR1201	CE, E1R	720
ANT805		675	CR2012	CE, E1R, EAC	713
ANT810		675	CR2014	CE, E1R, EAC	713
ANT815		675	CR2016	CE, E1R, EAC	713
ANT820		675	CR2031	CE, E1R, EAC	713
ANT830		675	CR2032	CE, E1R, EAC	713
ANT910		675	CR2033	CE, E1R, EAC	713
ANT930		675	CR2050	CE	712
AP3002		653	CR2051	CE	712
AP3022		654	CR2052	CE	712
AP3032		654	CR2520	CE, E1R, EAC	713
AP3042		654	CR2530	CE, E1R, EAC	704

Order no.	Approvals	Catalogue page
CR2532	CE, E1R, EAC	705
CR3001	CE	732
CR3002	CE	732
CR3003	CE	732
CR3004	CE	732
CR3008	CE	732
CR3020	CE	728
CR3114	CE	728
CR3130	CE	728
CR3131	CE	729
CR7032	CE, E1R, EAC	438
CR7132	CE, E1R, EAC	438
CR9221	CE, E1R	699
CR9222	CE, E1R	699
CR9223	CE, E1R	719
CR9224	CE, E1R	719
CR9225	CE, E1R	719
CR9226	CE, E1R	719
CR9227	CE, E1R	719
DA1025	CE, CUL	375
DD0203	CE, CUL, EAC	373
DD0296	CE, CUL, EAC	373
DD1105	CE, CUL	375
DD1115	CE, CUL	375
DD2503	CE, CUL, EAC	372
DD2505	CE, CUL, EAC	372
DD2603	CE, CUL, EAC	372
DD2605	CE, CUL, EAC	372
DF1100	CE, CUL	866
DF1208	CE, CUL	866
DF1210	CE, CUL	866
DF1212	CE, CUL	866
DF1214	CE, CUL	866
DF1216	CE, CUL	866
DF2100	CE, CUL	866
DF2208	CE, CUL	867
DF2210	CE, CUL	867
DF2212	CE, CUL	866
DF2214	CE, CUL	866
DF2216	CE, CUL	867
DI0101	CE	360
DI0104	CE	360
DI103A	CE	361
DI5009	CE, EAC	360
DI5020	CE	360
DI5021	CE	360
DI5022	CE	360
DI5026	CE	360
DI505A	CE	361
DI506A	CE	361

Order no.	Approvals	Catalogue page
DI520A	CE	360
DI523A	CE	360
DI6001	CE, CUL, EAC	360
DI602A	CE	361
DL0201	CE, CUL	373
DL0203	CE, CUL	373
DL2503	CE, CUL, EAC	375
DN0210	CE, CUL, EAC	362, 864
DN0220	CE, CUL, EAC	864
DN1022	CE, CUL	865
DN1030	CE, CRUUS, CUL	865
DN1031	CE, CRUUS, CUL	865
DN2036	CE, CUL	866
DN4011	CE, CRUUS, CUL	865
DN4012	CE, CRUUS, CUL	865
DN4013	CE, CRUUS, CUL	865
DN4014	CE, CRUUS, CUL	865
DN4032	CE, CRUUS, CUL	865
DN4033	CE, CRUUS, CUL	866
DN4034	CE, CRUUS, CUL	866
DP2200	CE	376
DR2503	CE, CUL, EAC	374
DR2505	CE, CUL, EAC	374
DS2503	CE, CUL, EAC	373
DS2505	CE, CUL, EAC	374
DS2506	CE, CUL, EAC	374
DS2603	CE, CUL, EAC	374
DS2605	CE, CUL, EAC	374
DTA100	CE, CUL	634, 660
DTA101	CE, CUL	634, 660
DTA200	CE, CUL	634, 660
DTA201	CE, CUL	635, 661
DTA300	CE, CUL	635, 661
DTA301	CE, CUL	635, 661
DTE100	CE, CUL, PI	662, 666
DTE101	CE, CUL, PI	663, 667
DTE102	CE, CUL	663, 667
DTE103	CE, CUL	663, 667
DTE104	CE, CUL	663, 667
DTE810	CE	674
DTE820		674
DTE910	CUL	674
DTE920		674
DTM424	CE, CUL, E1R	668, 735
DTM425	CE, CUL, E1R	668, 735
DTM426	CE, CUL, E1R	668, 735
DTM427	CE, CUL, E1R	668, 735
DTM434	CE, CUL, E1R	669, 735
DTM435	CE, CUL, E1R	669, 735
DTM436	CE, CUL, E1R	669, 735

**Standards and approvals /
list of articles**

Order no.	Approvals	Catalogue page	Order no.	Approvals	Catalogue page
DTM437	CE, CUL, E1R	669, 735	E10736		131, 173
DU110S	CE	375	E10737		132, 173
DW2503	CE, CUL, EAC	375	E10741		130
DX2021	CE	376	E10742		131
DX2022	CE	376	E10743		132
DX2023	CE	376	E10749		186
DX2031	CE	376	E10750		186
DX2032	CE	376	E10751		186
DX2033	CE	376	E10752		186
DX2041	CE	376	E10753		186
DX2042	CE	376	E10754		186
DX2051	CE	376	E10802		621
DX2052	CE	376	E10806		130
E10013		763	E10807		131
E10014		129	E10808		132
E10015		130	E10848		129
E10016		129	E10849		130
E10017		129, 471	E10865		756
E10024		130	E10866		756
E10025		130	E10867		756
E10027		131	E10868		757
E10028		131	E10880		173
E10030		132	E10886		765
E10031		132	E10887		765
E10058		766	E10976		758
E10076		131, 172	E10977		758
E10077		132, 172	E11027		172
E10136		757	E11030		172
E10137		763	E11032		172
E10154		130	E11034		172
E10155		129	E11036		172
E10189		765	E11037		173
E10190		765	E11043		766
E10191		765	E11047		130, 187
E10192		129	E11048		131, 187
E10193		129, 471	E11049		132, 256
E10200		765	E11078		172
E10204		129	E11114		130
E10221		129, 186	E11115		131
E10261		765	E11226		763
E10437		836	E11227		763
E10447		764	E11231		394, 759
E10448		764	E11232		394, 759
E10579		331, 593	E11248		765
E10584		331, 593	E11249	CRUUS	765
E10585		331, 593	E11250		765
E10597		331, 593	E11251		766
E10730		132, 662	E11310		331, 593
E10734		129, 186	E11311		394, 759
E10735		130, 173	E11416		809

Order no.	Approvals	Catalogue page	Order no.	Approvals	Catalogue page
E11417		809	E11597		715, 746
E11418		809	E11598		715, 746
E11419		809	E11599		715, 746
E11420		809	E11645		763
E11421		809	E11697		763
E11422		809	E11736		764
E11423		809	E11737		764
E11424		809	E11738		764
E11425		810	E11739		764
E11426		810	E11740		764
E11427		810	E11741		764
E11428		810	E11742		764
E11429		810	E11743		764
E11430		810	E11744		765
E11431		810	E11745		764
E11432		810	E11746		764
E11433		810	E11747		764
E11434		810	E11775		843
E11435		810	E11796		204
E11436		810	E11797		203
E11437		810	E11798		205
E11438		811	E11799		203
E11439		811	E11801		203
E11440		811	E11803		186
E11504	CRUUS	715, 789	E11807		394, 759
E11505	CRUUS	716, 789	E11816		201
E11506	CRUUS	715, 789	E11817		201
E11507	CRUUS	716, 789	E11818		201
E11508	CRUUS	757	E11819		201
E11509	CRUUS	757	E11820		201
E11510		757	E11821		201
E11511	CRUUS	715, 729	E11822		202
E11512	CRUUS	758	E11823		202
E11521		129	E11846		202
E11530		129	E11847		621
E11531		129	E11857		790
E11533		130	E11858		790
E11534		131	E11859		790
E11550		788	E11860		716, 790
E11551		788	E11861		770
E11552		755	E11862		770
E11553		756	E11863		771
E11569		406	E11864		776
E11589		715, 746	E11865		776
E11590		715, 746	E11872		204
E11591		715, 746	E11877		202
E11592		715, 746	E11890		204
E11593		715, 746	E11891		204
E11594		715, 747	E11892		204
E11596		715, 746	E11894		204

**Standards and approvals /
list of articles**

Order no.	Approvals	Catalogue page	Order no.	Approvals	Catalogue page
E11895		204	E12260		394
E11898		394, 664	E12274		293
E11912		203	E12291		186
E11913		203	E12315		664, 671
E11914		205	E12317		664, 671
E11928		205	E12319		664, 671
E11930		437	E12321		664, 671
E11950		394, 759	E12339		763
E11957		204	E12340		763
E11958		202	E12355		721
E11959		203	E12375		204
E11960		203	E12377		171
E11961		202	E12378		171
E11975		202	E12379		171
E11976		202	E12380		171
E11977		202	E12386		172
E11978		202	E12402		353
E11979		202	E12405		688
E11980		202	E12412		131
E11981		202	E12413		132
E11982		202	E12414		132
E11984		331, 593	E12432		353
E11988		204	E12452		130
E11994	CE	130	E12453		131
E11995	CE	131	E12454		132
E11996	CE	132	E12457		760
E12004		205	E12470		332, 593
E12015		203	E12476		332, 593
E12017		203	E12478		332, 594
E12090		394, 664	E12481		841
E12153		173	E12501		332, 593
E12163		173	E12502		760
E12164		204	E12503		760
E12166		759	E12504		761
E12167		759	E12505		760
E12168		759	E12506		760
E12169		759	E12515		332, 593
E12170		332, 594	E12516		330, 592
E12204		394, 664	E12517		330, 592
E12205		394, 664	E12519		332, 594
E12208		331, 593	E12520		332, 594
E12209		331, 593	E12521		332, 594
E12212		331, 593	E12522		332, 594
E12215		715, 747	E12523		332, 594
E12218		204	E12524		332, 594
E12231		203	E12526		331, 592
E12232		203	E12537	CE	185
E12233		203	E12538	CE	185
E12234		203	E12539	CE	185
E12259		204	E12540	CE	185

Order no.	Approvals	Catalogue page	Order no.	Approvals	Catalogue page
E12541	CE	186	E20106		307
E12542		654	E20107		307
E12543		778	E20127		305
E12544		778	E20128		305
E12545		778	E20129		305
E12546		858	E20130		305
E12547		858	E20211		307
E12548		858	E20228		305
E12549		777	E20230		306
E12550		777	E20249		306
E12551		777	E20353		308
E12552		858	E20401		385
E12553		858	E20428		766
E12554		858	E20430		766
E12558		858	E20452		253
E12559		858	E20453		254
E12560		859	E20454		254
E12561		859	E20489		307
E12562		859	E20492		306
E12563		859	E20493		306
E12565		778	E20494		307
E12566		778	E20495		307
E17119		330, 592	E20505		306
E17205		330, 592	E20506		306
E17295		331, 592	E20507		307
E17296		331, 592	E20590		255
E17328		330, 592	E20593		307
E17329		331, 592	E20600		308
E19503		131	E20603		301
E1D100		287, 292	E20606		301
E20003		253	E20609		301
E20004		253	E20612		301
E20005		253	E20615		301
E20051		306	E20633		302
E20052		306	E20639		302
E20053		306	E20645		302
E20054		306	E20648		302
E20055		306	E20651		302
E20056		306	E20654		302
E20057		306	E20679		307
E20058		306	E20680		307
E20059		305	E20711		302
E20060		305	E20712		302
E20061		305	E20714		301
E20062		305	E20715		302
E20078		307	E20716		260
E20102		308	E20717		260
E20103		308	E20718		133, 187
E20104		308	E20719		133, 187
E20105		308	E20720		217, 256

**Standards and approvals /
list of articles**

Order no.	Approvals	Catalogue page	Order no.	Approvals	Catalogue page
E20721		217, 256	E20946		384, 681
E20722		285, 319	E20948		384, 681
E20724		254	E20950		261
E20737		285	E20951		217, 256
E20738		758	E20952		385
E20744		254	E20953		253
E20748		302	E20954		253
E20749		302	E20956		253
E20750		301	E20964		257, 319
E20752		301	E20965		257, 319
E20753		301	E20966		257, 320
E20754		307	E20968		257, 319
E20755		307	E20969		257, 319
E20756		302	E20974		257, 319
E20757		301	E20984		257, 319
E20762		307	E20988		285
E20765		303	E20989		285
E20767		303	E20990		284
E20772		302	E20991		284
E20773		303	E20992		284
E20774		303	E20993		284
E20794		286	E20994		285
E20796		260	E21015		254, 385
E20838		758	E21076		385, 681
E20843		260	E21079		287, 293
E20844		260	E21081		260, 288
E20856		133	E21083		259, 287
E20857		133	E21084		259, 287
E20860		133	E21085		258, 286
E20861		133	E21086		258, 286
E20864		133	E21087		258, 286
E20865		133	E21088		258, 259
E20866		133, 187	E21095		257, 319
E20867		133, 187	E21102		301
E20869		133, 187	E21103		301
E20870		133, 187	E21104		301
E20873		133, 256	E21105		303
E20874		133, 256	E21106		303
E20875		134, 256	E21107		303
E20893		255	E21109		384, 681
E20901		662	E21110		260, 384
E20903		254	E21111		385
E20907		254	E21112		385, 681
E20911		254	E21113		385, 681
E20914		254	E21114		258, 286
E20915		254	E21117		259
E20938		217, 256	E21118		260
E20939		385, 389	E21119		260
E20940		217, 261	E21120		259, 287
E20941		385, 681	E21122		258, 259

Order no.	Approvals	Catalogue page	Order no.	Approvals	Catalogue page
E21125		261	E21269		254
E21126		261	E21270		254
E21133		287, 293	E21271		258
E21137		394, 726	E21272		258
E21138		394, 726	E21273		258
E21139		394, 726	E21277		258
E21140		394	E21280		258
E21142		259, 287	E23000		217
E21159		287, 292	E2D108		384
E21165		385, 682	E2D109		384
E21166		385, 682	E2D110		384, 680
E21168		385, 682	E2D112		384, 680
E21169		682	E2D114		399, 681
E21171		287, 293	E2D115		398
E21172		385	E2D116		399, 681
E21200		255	E2D200		383
E21201		255	E2D201		398, 681
E21202		255	E2D202		398
E21203		255	E2D400		384, 389
E21204		261, 288	E2D401		384, 389
E21206		217, 256	E2D402		384, 389
E21207		217, 256	E2I200		680
E21208		261, 288	E2I210		680
E21209		261, 288	E2I211		680
E21210		259, 286	E2I212		680
E21211		259, 286	E2I213		680
E21212		259, 286	E2M200		725
E21213		261, 321	E2M201		725
E21214		261, 321	E2M203		725
E21215	CUL	259	E2M205		725
E21216		260	E2M206		725
E21217		260	E2M210		725
E21218		260	E2M211		725
E21219		285	E2M212		725
E21220		285	E2M213		725
E21221		258, 320	E2M250	CE, E4	725
E21222		257, 319	E2M251		725
E21223		259, 286	E2M252		725
E21224		287	E2V100		383
E21228		389, 393	E30000		473
E21229		389, 393	E30003		473
E21232		389, 393	E30009		477
E21236		287	E30010		473
E21237	CE	257	E30013	EC19352004, EHEDG, FDA	477
E21238	CE	257	E30016	Reg31	566
E21239	CE	257	E30017		566
E21240	CE	257	E30018		566
E21248		293	E30024	CRN	566
E21267		254	E30025		566
E21268		254	E30047		566

**Standards and approvals /
list of articles**

Order no.	Approvals	Catalogue page	Order no.	Approvals	Catalogue page
E30049		566	E30429		473
E30050		474	E30430		473
E30055	EC 19352004, EHEDG, FDA	531, 570	E30435		474
E30056	EC 19352004, EHEDG, FDA	532, 570	E33201	CRN, EC 19352004, EHEDG, FDA	474, 503
E30057		471	E33202	CRN, EC 19352004, EHEDG, FDA	474, 504
E30058	CRN	474	E33208	CRN, EC 19352004, EHEDG, FDA	474
E30070		477	E33209	CRN, EC 19352004, EHEDG, FDA	474
E30072	ACS, EC 19352004, FDA	477	E33211	EC 19352004, EHEDG, FDA	475, 504
E30073		566	E33212	EC 19352004, EHEDG, FDA	475, 504
E30076		472	E33213	EC 19352004, EHEDG, FDA	476, 504
E30077		472	E33221	EC 19352004, EHEDG, FDA	475, 504
E30080	CE	687	E33222	EC 19352004, EHEDG, FDA	475, 504
E30091		565	E33228	EC 19352004, EHEDG, FDA	475
E30094		472, 567	E33229	EC 19352004, EHEDG, FDA	475
E30108		566	E33242	EC 19352004, FDA	476, 505
E30112		395, 689	E33243	EHEDG	475
E30115		690	E33304	EC 19352004, FDA	476
E30116		474	E33340	EC 19352004, FDA	476
E30122	ACS, EC 19352004, EHEDG, FDA, Reg31	476, 505	E33401	EC 19352004, EHEDG, FDA	531, 569
E30123	EC 19352004, FDA	474	E33402	EC 19352004, EHEDG, FDA	531, 569
E30124	EC 19352004, FDA	474	E33430	EC 19352004, EHEDG, FDA	532, 569
E30128	EC 19352004, EHEDG, FDA	476, 569	E33431		566
E30130	ACS, CRN, EC 19352004, EHEDG, FDA	476	E33601	EC 19352004, EHEDG, FDA	477
E30132		690	E33602		477
E30135		474	E33612	EC 19352004, EHEDG, FDA	477
E30136		687	E33701	EC 19352004, EHEDG, FDA	474, 504
E30137		687	E33702	EC 19352004, EHEDG, FDA	475, 504
E30139		473	E33711	EC 19352004, EHEDG, FDA	475, 504
E30140		472	E33712	EC 19352004, EHEDG, FDA	475, 504
E30141		472	E33713	EC 19352004, EHEDG, FDA	476, 504
E30142		473	E33721	EC 19352004, EHEDG, FDA	475, 504
E30143		473	E33722	EC 19352004, EHEDG, FDA	475, 504
E30144	EC 19352004, EHEDG, FDA	566	E33731	EC 19352004, EHEDG, FDA	476, 504
E30390	CE	472, 530	E33732	EC 19352004, EHEDG, FDA	476, 504
E30391	CUL	473	E35010		563
E30393	EC 19352004, EHEDG, FDA	563	E35020		563
E30397		563	E35030		563
E30398	CE, CUL	171, 256	E35050		563
E30399		472, 538	E35060		561
E30400		472, 538	E35061		561
E30401		472, 538	E35062		561
E30402		472, 538	E35063		561
E30403	EC 19352004, EHEDG, FDA	563	E35065		562
E30405	CE	472, 562	E35066		562
E30407	EC 19352004, EHEDG, FDA	566	E35067		562
E30419		472	E35068		561
E30420		471	E37211		564
E30421		471, 561	E37221		564
E30422		472	E37340		472
E30427		473	E37350		473

Order no.	Approvals	Catalogue page	Order no.	Approvals	Catalogue page
E37411	EC19352004, FDA	565	E3M159		724
E37421	EC19352004, FDA	565	E3M160		724
E37430	EC19352004, FDA	565	E40048		505
E37431	EC19352004, FDA	565	E40078		501
E37450	EC19352004, FDA	565	E40079		501
E37511	EC19352004, EHEDG, FDA	564	E40083		501
E37521	EC19352004, EHEDG, FDA	565	E40096		503, 567
E37600		565	E40097		503, 567
E37603		564	E40098		503, 567
E37610		565	E40099	CRN	502, 567
E37613		564	E40100		502, 567
E37620		565	E40101		502, 567
E37623		564	E40104		502, 567
E37640		565	E40106		502
E37643		564	E40107	CRN	567
E37663		564	E40114		502, 567
E37700		565	E40115		502
E37710		565	E40124	Reg31	503, 566
E37720		565	E40128		567
E37810	EC19352004, EHEDG, FDA	564	E40129		503
E37820	EC19352004, EHEDG, FDA	564	E40136		501
E37830	EC19352004, EHEDG, FDA	564	E40138		503
E37850	EC19352004, EHEDG, FDA	564	E40148		566
E37910	EC19352004, EHEDG, FDA	564	E40151		506
E37920	EC19352004, EHEDG, FDA	564	E40153		506
E37930	EC19352004, EHEDG, FDA	564	E40161		502
E37950	EC19352004, EHEDG, FDA	564	E40162		502
E3D103		389, 393	E40163		502
E3D200		389	E40164		502
E3D201		393	E40171		503, 583
E3D300		389, 393	E40178		505
E3D301		389, 393	E40179	Reg31	505
E3D302	CE	393	E40180	ACS, Reg31	505
E3D303	CE	393	E40189		505
E3D304	CE	393	E40195	CRN	503
E3M100		723	E40199	ACS, Reg31	505
E3M101		723	E40203		503
E3M102		723	E40205		506
E3M103		723	E40213	Reg31	506
E3M120		723	E40214		506
E3M121		723	E40215		506
E3M122		723	E40216		506
E3M123		723	E40217		506
E3M131		724	E40227		506
E3M132		724	E40228		506
E3M133		724	E40229		506
E3M151		724	E40230	ACS	506
E3M152		724	E40231		506
E3M153		724	E40234		507
E3M154		724	E40240	ACS	506

**Standards and approvals /
list of articles**

Order no.	Approvals	Catalogue page	Order no.	Approvals	Catalogue page
E40249		503	E43215		536
E40250		506	E43216		536
E40251		507	E43217		536
E40252		505	E43218		536
E40253		505	E43219		536
E40254		505	E43220		536
E40258		501	E43221		537
E40259		501	E43223		537
E40260		501	E43224		537
E40261		502	E43225		534
E40262		502	E43226		534
E40263		502	E43227		534
E40264		502	E43228		536
E40265	ACS, KTW, Reg31	503	E43229		536
E40267	ACS, KTW, Reg31	501	E43230		535
E40268	ACS, KTW, Reg31	501	E43300	EC19352004, EHEDG, FDA	531, 569
E40269		505	E43301	EC19352004, EHEDG, FDA	531, 569
E40434		503	E43302	EC19352004, EHEDG, FDA	532
E43000		530	E43303	CRN, EC19352004, EHEDG, FDA	532
E43001		529	E43304	EC19352004, EHEDG, FDA	532, 569
E43002		530	E43305	EC19352004, EHEDG, FDA	532, 569
E43003		529	E43306	EC19352004, EHEDG, FDA	532, 570
E43004		530	E43307	EC19352004, EHEDG, FDA	532, 570
E43006		529	E43308	EC19352004, EHEDG	532, 570
E43007		529	E43309	CRN, EC19352004, EHEDG, FDA	533, 570
E43008		529	E43310	EC19352004, EHEDG, FDA	533, 570
E43009		530	E43311	EC19352004, EHEDG, FDA	533, 570
E43012		529	E43312	EC19352004, EHEDG, FDA	533, 570
E43013		530	E43313	EC19352004	532
E43014		529	E43314		532, 570
E43016		530	E43315	EC19352004, EHEDG, FDA	533, 571
E43019		529	E43316	EC19352004, EHEDG	532
E43100		530	E43317	EC19352004, EHEDG	532
E43101		530	E43318	EC19352004, EHEDG	532
E43102		530	E43319	EC19352004, FDA	571
E43103		530	E43320		537
E43201		533	E43330		693
E43202		533	E43331		693
E43203		534	E43332		693
E43204		534	E43333		537
E43205		534	E43334		537
E43206		533	E43336		536
E43207		534	E43337		534
E43208		534	E43340	EC19352004, EHEDG, FDA	535
E43209		535	E43341	EC19352004, EHEDG, FDA	535
E43210		535	E43342	EC19352004, EHEDG, FDA	535
E43211		536	E43345	EC19352004, EHEDG, FDA	535
E43212		536	E43346	EC19352004, EHEDG, FDA	535
E43213		536	E43347	EC19352004, EHEDG, FDA	535
E43214		536	E43348	EC19352004, EHEDG, FDA	535

Order no.	Approvals	Catalogue page	Order no.	Approvals	Catalogue page
E43351		534	E60138		352
E43352		534	E60193		352
E43353		535	E60206		350
E43354		535	E60207		351
E43355		536	E60208		351
E43356		536	E60209		351
E43375		531	E60302		350
E43376		532	E60303		362
E43377		536	E7000A		623
E43378		537	E7001S		442, 646
E43379		534	E7002S		442, 646
E43380		534	E7003S		442, 646
E43381		534	E7004S		442, 646
E43382		533	E7005S		442, 646
E43383		533	E70062		624
E43384		533	E70067		624
E43385		533	E7006S	CE	442, 647
E43400		693	E7007S	CE	441, 645
E43900		172	E7008S		647
E43902		172	E70096		621
E43904		172	E70113		624
E43910		530	E70142		766
E43911		566	E70211		623
E60006		352	E70213		623
E60022		351	E70230		620
E60027		351	E70231		620
E60028		351	E70232		620
E60033		350	E70233		620
E60034		350	E70236		620
E60035		350	E70297		622
E60036		350	E70299		624
E60041		350	E70320		623
E60062		351	E70354	CUL	619
E60063		351	E70377	CUL	619
E60064		351	E70381		620
E60065		351	E70390		624
E60066		351	E70399		624
E60067		351	E7040S		442, 646
E60076		352	E70413		624
E60095		352	E70423		623
E60098		352	E70424		713
E60110		352	E70432		622
E60111		352	E70440		622
E60112		352	E70442		622
E60117		351	E70454	CUL	619
E60118		352	E70471		621
E60119		351	E70481		621
E60120		351	E70483		621
E60121		351	E70485		620
E60137		352	E70486		620

**Standards and approvals /
list of articles**

Order no.	Approvals	Catalogue page	Order no.	Approvals	Catalogue page
E70487		620	E80310		261, 288
E70498		621	E80311		661
E70499		621	E80312		661
E7050S		442, 646	E80317		661
E7051S		442, 646	E80318		661
E7052S		442, 646	E80319		661
E7053S	CE, CUL	442, 646	E80320		661
E70580	CE, CUL	622	E80321	CE	662
E70581	CUL	621	E80322		661
E70582	CUL	621	E80330		675
E70585	CUL	621	E80331		676
E70586	CUL	621	E80332		676
E70588	CUL	620	E80333		676
E70600	CUL	620	E80340		676
E73004		622	E80341		669
E73005		622	E80342		669
E73006		622	E80343		669
E73007		622	E80344		669
E73008		622	E80345		661
E73009		622	E80346		661
E7354A	CE	620	E80347		669
E7377A	CE	620	E80348		671
E74000		623	E80349		669
E74010		623	E80351		675
E74100		623	E80353		675
E74110		623	E80354		675
E74200	CRUUS, CSA	623	E80360		664
E74210	CRUUS, CSA	623	E80361		664
E74300		623	E80370		670
E74310	CSA, CRUUS	623	E80371		670
E75222		622	E80372		171
E75227		632	E80373		171
E75228		632	E80374		171
E75229		632	E80375		171
E75231		632	E80376		171
E75232		632	E80377		670
E7901S		647	E80379		670
E7902S		647	E80380		670
E7903S		647	E80381		670
E7904S		647	E80382		670
E7905S		647	E80383		670
E7906S		647	E80384		670
E7999S		621	E80385		670
E79998		621	E80387		669
E80100	CE	377	E80388		669
E80102	CE	377	E80390		670
E80110	CE	377	E80391		670
E80301		661	E80392		670
E80302		662	E80400		670
E80304		662	E80401		670

Order no.	Approvals	Catalogue page
E84016	CE, CRUUS, CUL	865
E84036	CE, CRUUS, CUL	866
E89005	CE	377
E89010		362, 378
E89013		362, 378
E89150	CE	377
E89208		378
EBC001	CUL	839
EBC002	CUL	839
EBC003	CUL	841
EBC004	CUL	841
EBC005	CUL	839
EBC006	CUL	839
EBC007	CUL	841
EBC008	CUL	841
EBC009	CUL	839
EBC010	CUL	839
EBC011	CUL	841
EBC012	CUL	841
EBC013	CUL	838
EBC014	CUL	840
EBC015	CUL	838
EBC016	CUL	840
EBC017	CUL	838
EBC018	CUL	840
EBC019	CUL	838
EBC020	CUL	840
EBC021	CUL	839
EBC022	CUL	840
EBC023	CUL	839
EBC024	CUL	840
EBC025	CUL	838
EBC026	CUL	840
EBC027	CUL	838
EBC028	CUL	840
EBC029	CUL	838
EBC030	CUL	840
EBC031	CUL	838
EBC032	CUL	840
EBC033	CUL	839
EBC034	CUL	840
EBC035	CUL	839
EBC036	CUL	840
EBC048	CUL	836
EBC049		836
EBC050	CUL	836
EBC051	CUL	836
EBC052		836
EBC053	CUL	837
EBC054	CUL	837

Order no.	Approvals	Catalogue page
EBC055	CUL	837
EBC056	CUL	837
EBC057		837
EBC058	CUL	837
EBC059		837
EBC060	CUL	837
EBC061	CUL	837
EBC062		837
EBC063	CUL	837
EBC064	CUL	838
EBC065	CUL	838
EBC066	CUL	838
EBC067		838
EBC112		841
EBC113	CE, CUL	841
EBC114	CE, CUL	841
EBC115	CE, CUL	842
EBC116	CE, CUL	842
EBC117	CE, CUL	842
EBC118	CE, CUL	842
EBC136		842
EBC137		842
EBC138		842
EBC139		842
EBF006		843
EBF007		843
EBF008		843
EBF009		843
EBF010		844
EBF011		844
EBT006	CE	842
EBT007	CE	842
EBT008	CE	843
EBT009	CE	843
EBT010	CE	843
EBT011	CE	843
EC0400	CE, E1R	698
EC0401		699
EC0402		699
EC0403		699
EC0404		700
EC0405		700
EC0406		700
EC0407		700
EC0408		700
EC0409		700
EC0410		700
EC0451		700
EC0452		700
EC0453		700

**Standards and approvals /
list of articles**

Order no.	Approvals	Catalogue page	Order no.	Approvals	Catalogue page
EC0454		700	EC2082	CE, EAC	368, 736
EC0455		700	EC2084		438, 707
EC0456		700	EC2086		439, 707
EC0457		701	EC2088		716
EC0458		700	EC2089		708, 714
EC0459		701	EC2090		708, 714
EC0460		701	EC2091		708
EC0461		701	EC2095	CE, E1	726
EC0462		701	EC2096		708
EC0463		701	EC2097		439, 707
EC0464		701	EC2098		714
EC0465		701	EC2099		721
EC0466		701	EC2110		720
EC0467		701	EC2112	CE	701, 723
EC0468		701	EC2113		701, 728
EC0469		701	EC2114		702, 723
EC0470		701	EC2115		720
EC0701		706	EC2116		729
EC0702		706	EC2117		720
EC0710		706	EC2118		729
EC0711		706	ENC01A	IEC	776
EC0720		706	ENC02A	IEC	776
EC0721		706	ENC03A	IEC	776
EC1410		720	ENC04A	IEC	776
EC1411		720	ENC05A	IEC	776
EC1412		720	ENC06A	IEC	776
EC1413		720	ENC07A	IEC	777
EC1414		720	ENC08A	IEC	777
EC1520		707, 714	ENC09A	IEC	777
EC1521		707, 714	ENC10A	IEC	777
EC1522		708, 714	ENC11A	IEC	777
EC1523		708, 714	ENC12A	IEC	777
EC1524		708, 714	ENC13A	IEC	777
EC1533		708, 714	ENC14A	IEC	777
EC2013		438, 707	EVC001	CE, CUL	744, 757
EC2015	CE	708, 716	EVC002	CE, CUL	744, 757
EC2016	CE	708, 716	EVC003	CE, CUL	744, 757
EC2019	CE, EAC	368, 736	EVC004	CE, CUL	744, 757
EC2025		732	EVC005	CE, CUL	744, 757
EC2032		708	EVC006	CE, CUL	744, 757
EC2045	CE, EAC	368, 736	EVC007	CUL	757
EC2046		439, 707	EVC008	CUL	757
EC2053		708, 714	EVC009	CUL	758
EC2056		716	EVC010	CE, CUL	744, 804
EC2060	CE, EAC	368, 736	EVC011	CE, CUL	804
EC2061	CE	368, 736	EVC012	CE, CUL	744, 804
EC2062		716, 729	EVC013	CE, CUL	804
EC2075		708	EVC014	CE, CUL	804
EC2076		708	EVC015	CE, CUL	804
EC2080		395, 689	EVC016	CE, CUL	804

Order no.	Approvals	Catalogue page
EVC017	CE, CUL	804
EVC018	CE, CUL	804
EVC019	CE, CUL	804
EVC020	CUL	804
EVC021	CUL	804
EVC022	CUL	804
EVC023	CUL	804
EVC024	CUL	805
EVC025	CE, CUL	805
EVC026	CE, CUL	805
EVC027	CE, CUL	805
EVC028	CE, CUL	805
EVC029	CE, CUL	805
EVC030	CE, CUL	805
EVC031	CE, CUL	805
EVC032	CE, CUL	805
EVC033	CE, CUL	805
EVC034	CE, CUL	805
EVC035	CUL	805
EVC036	CUL	805
EVC037	CUL	805
EVC038	CUL	806
EVC039	CUL	671, 806
EVC040	CE, CUL	803
EVC041	CE, CUL	803
EVC042	CE, CUL	803
EVC043	CE, CUL	803
EVC044	CE, CUL	803
EVC045	CE, CUL	802
EVC046	CE, CUL	803
EVC047	CE, CUL	803
EVC048	CE, CUL	803
EVC049	CE, CUL	803
EVC04A	CE, IEC	776
EVC050	CUL	803
EVC051	CUL	803
EVC052	CUL	803
EVC053	CUL	803
EVC054	CUL	803
EVC055	CE, CUL	806
EVC056	CE, CUL	806
EVC057	CE, CUL	806
EVC058	CE, CUL	806
EVC059	CE, CUL	806
EVC05A	CE, IEC	776
EVC060	CE, CUL	806
EVC061	CE, CUL	806
EVC062	CE, CUL	806
EVC063	CE, CUL	806
EVC064	CE, CUL	806

Order no.	Approvals	Catalogue page
EVC065	CE, CUL	806
EVC066	CE, CUL	806
EVC067	CE, CUL	807
EVC068	CE, CUL	807
EVC069	CE, CUL	671, 807
EVC06A	CE, IEC	776
EVC070	CE, CUL	758
EVC071	CE, CUL	758
EVC072	CE, CUL	758
EVC073	CE, CUL	758
EVC074	CE, CUL	758
EVC075	CE, CUL	758
EVC076	CE, CUL	789
EVC077	CE, CUL	789
EVC078	CE, CUL	789
EVC079	CE, CUL	788
EVC07A	CE, IEC	828
EVC080	CE, CUL	788
EVC081	CE, CUL	789
EVC094	CE, CUL	789
EVC095	CE, CUL	789
EVC09A	CE, IEC	828
EVC10A	CE, IEC	828
EVC11A	CE, IEC	828
EVC12A	CE, IEC	828
EVC13A	CE, IEC	828
EVC141	CUL	754
EVC142	CUL	755
EVC143	CUL	755
EVC144	CUL	755
EVC145	CUL	755
EVC146	CUL	755
EVC147	CUL	755
EVC148	CUL	755
EVC149	CUL	755
EVC14A	CE, CUL	777
EVC150	CUL	755
EVC151	CUL	755
EVC152	CUL	755
EVC153	CUL	755
EVC154	CUL	756
EVC155	CUL	756
EVC161	CE, CUL	756
EVC162	CE, CUL	756
EVC163	CE, CUL	756
EVC164	CE, CUL	756
EVC165	CE, CUL	756
EVC166	CE, CUL	756
EVC210	CUL	799
EVC211	CUL	799

**Standards and approvals /
list of articles**

Order no.	Approvals	Catalogue page	Order no.	Approvals	Catalogue page
EVC212	CUL	799	EVC262	CUL	796
EVC213	CUL	799	EVC263	CUL	796
EVC214	CUL	799	EVC264	CUL	796
EVC215	CUL	798	EVC265	CUL	795
EVC216	CUL	798	EVC266	CUL	795
EVC217	CUL	798	EVC267	CUL	795
EVC218	CUL	798	EVC268	CUL	795
EVC219	CUL	798	EVC269	CUL	795
EVC220	CUL	799	EVC270	CUL	796
EVC221	CUL	799	EVC271	CUL	796
EVC222	CUL	799	EVC272	CUL	796
EVC223	CUL	799	EVC273	CUL	797
EVC224	CUL	799	EVC274	CUL	797
EVC225	CUL	798	EVC275	CUL	794
EVC226	CUL	798	EVC276	CUL	794
EVC227	CUL	798	EVC277	CUL	794
EVC228	CUL	798	EVC278	CUL	794
EVC229	CUL	799	EVC279	CUL	795
EVC230	CUL	798	EVC280	CUL	795
EVC231	CUL	798	EVC281	CUL	795
EVC232	CUL	798	EVC282	CUL	795
EVC233	CUL	798	EVC283	CUL	795
EVC234	CUL	798	EVC284	CUL	795
EVC235	CUL	799	EVC285	CUL	801
EVC236	CUL	799	EVC286	CUL	801
EVC237	CUL	799	EVC287	CUL	801
EVC238	CUL	800	EVC288	CUL	801
EVC239	CUL	800	EVC289	CUL	802
EVC240	CUL	800	EVC290	CUL	802
EVC241	CUL	800	EVC291	CUL	802
EVC242	CUL	800	EVC292	CUL	802
EVC243	CUL	800	EVC293	CUL	802
EVC244	CUL	800	EVC294	CUL	802
EVC245	CUL	800	EVC295	CUL	802
EVC246	CUL	800	EVC296	CUL	802
EVC247	CUL	800	EVC297	CUL	802
EVC248	CUL	800	EVC298	CUL	802
EVC249	CUL	800	EVC299	CUL	802
EVC250	CUL	801	EVC300	CUL	797
EVC251	CUL	801	EVC301	CUL	797
EVC252	CUL	801	EVC302	CUL	797
EVC253	CUL	801	EVC303	CUL	797
EVC254	CUL	801	EVC304	CUL	797
EVC255	CUL	801	EVC305	CUL	795
EVC256	CUL	801	EVC306	CUL	795
EVC257	CUL	801	EVC307	CUL	795
EVC258	CUL	801	EVC308	CUL	796
EVC259	CUL	801	EVC309	CUL	796
EVC260	CUL	796	EVC310	CUL	797
EVC261	CUL	796	EVC311	CUL	797

Order no.	Approvals	Catalogue page	Order no.	Approvals	Catalogue page
EVC312	CUL	797	EVC707		760
EVC313	CUL	797	EVC708		760
EVC314	CUL	797	EVC709		760
EVC315	CUL	796	EVC710		760
EVC316	CUL	796	EVC711	CE	760
EVC317	CUL	796	EVC712	CE	760
EVC318	CUL	796	EVC713	CE	760
EVC319	CUL	796	EVC714	CE	760
EVC431	CE, CUL	856	EVC715	CE	760
EVC432	CE, CUL	856	EVC716	CE	807
EVC433	CE, CUL	856	EVC717	CE	807
EVC434	CE, CUL	856	EVC718	CE	807
EVC435	CE, CUL	856	EVC719	CE	807
EVC436	CE, CUL	856	EVC720	CE	807
EVC437	CUL	856	EVC721	CE	807
EVC438	CUL	857	EVC722	CE	807
EVC439	CUL	857	EVC723	CE	807
EVC492		353, 671	EVC724	CE	807
EVC526	CUL	744, 761	EVC725	CE	807
EVC527	CUL	744, 761	EVC726	CE	807
EVC528	CUL	745, 761	EVC727	CE	808
EVC529	CUL	745, 761	EVC728	CE	808
EVC530	CUL	745, 761	EVC729	CE	808
EVC531	CUL	745, 761	EVC730	CE	808
EVC532	CUL	745, 761	EVC731	CE	808
EVC533	CUL	745, 761	EVC732	CE	808
EVC534	CUL	745, 761	EVC733	CE	808
EVC535	CUL	745, 761	EVC734	CE	808
EVC536	CUL	745, 761	EVC735	CE	808
EVC537	CUL	745, 762	EVC736	CE	808
EVC538	CUL	745, 762	EVC737	CE	808
EVC539	CUL	745, 762	EVC738	CE	808
EVC540	CUL	745, 762	EVC739	CE	808
EVC541	CUL	745, 762	EVC740	CE	808
EVC542	CUL	745, 762	EVC741	CE	809
EVC543	CUL	745, 762	EVC742	CE	809
EVC544	CUL	746, 762	EVC743	CE	809
EVC545	CUL	746, 762	EVF001	CE, CUL	771
EVC546	CUL	746, 762	EVF002	CE, CUL	771
EVC547	CUL	746, 762	EVF003	CE, CUL	771
EVC548	CUL	746, 762	EVF004	CE, CUL	771
EVC549	CUL	746, 762	EVF005	CE, CUL	771
EVC644	CUL	759	EVF006	CE, CUL	771
EVC645	CUL	759	EVF007	CUL	772
EVC646	CUL	759	EVF008	CUL	772
EVC693		857	EVF009	CUL	772
EVC694		857	EVF010	CE, CUL	772
EVC695		857	EVF011	CE, CUL	772
EVC696		857	EVF012	CE, CUL	772
EVC706	CE	759	EVF013	CE, CUL	772

**Standards and approvals /
list of articles**

Order no.	Approvals	Catalogue page	Order no.	Approvals	Catalogue page
EVF014	CE, CUL	772	EVF510		826
EVF015	CE, CUL	772	EVF511		827
EVF040	CE, CUL	819	EVF512		827
EVF041	CE, CUL	819	EVF513		827
EVF042	CE, CUL	819	EVF514		827
EVF043	CE, CUL	819	EVF515		827
EVF044	CE, CUL	819	EVF516		827
EVF045	CE, CUL	819	EVF517		827
EVF046	CE, CUL	819	EVF518		790
EVF047	CE, CUL	819	EVF519		790
EVF048	CE, CUL	819	EVF520		790
EVF049	CE, CUL	819	EVF521		790
EVF050	CE, CUL	819	EVF522		790
EVF051	CE, CUL	820	EVF528		827
EVF052	CUL	820	EVF529		827
EVF053	CUL	820	EVF530		827
EVF054	CUL	820	EVF531		827
EVF055	CUL	820	EVF532		827
EVF056	CUL	820	EVF533		827
EVF057	CUL	820	EVF534		827
EVF480		775	EVM001	CE, CUL	778
EVF481		775	EVM002	CE, CUL	778
EVF482		775	EVM003	CE, CUL	778
EVF483		775	EVM004	CE, CUL	778
EVF484		775	EVM005	CE, CUL	778
EVF485	CE	775	EVM006	CE, CUL	778
EVF486	CE	775	EVM007	CUL	779
EVF487	CE	775	EVM008	CUL	779
EVF488	CE	775	EVM009	CUL	779
EVF489	CE	776	EVM010	CE, CUL	778
EVF490		825	EVM012	CE, CUL	778
EVF491		825	EVM014	CE, CUL	778
EVF492		825	EVM036	CE, CUL	353, 671
EVF493		825	EVM037	CE, CUL	779
EVF494		825	EVM038	CE, CUL	671, 779
EVF495		825	EVM039	CE, CUL	352, 779
EVF496		825	EVM040	CE, CUL	779
EVF497		826	EVM041	CE, CUL	779
EVF498		826	EVM068	CUL	779
EVF499		826	EVM069	CUL	779
EVF500		826	EVM070	CUL	779
EVF501		826	EVT001	CE, CUL	770
EVF502		826	EVT002	CE, CUL	770
EVF503		826	EVT003	CE, CUL	770
EVF504		826	EVT004	CE, CUL	770
EVF505		826	EVT005	CE, CUL	770
EVF506		826	EVT006	CE, CUL	770
EVF507		826	EVT007	CUL	770
EVF508		826	EVT008	CUL	770
EVF509		826	EVT009	CUL	770

Order no.	Approvals	Catalogue page	Order no.	Approvals	Catalogue page
EVT010	CE, CUL	771	EVT069	CUL	770
EVT011	CE, CUL	771	EVT071	CE, CUL	789
EVT012	CE, CUL	771	EVT072	CE, CUL	790
EVT013	CE, CUL	771	EVT073	CE, CUL	790
EVT014	CE, CUL	771	EVT074	CE, CUL	790
EVT015	CE, CUL	771	EVT079	CE, CUL	822
EVT022	CE, CUL	821	EVT110	CE, CUL	822
EVT023	CE, CUL	821	EVT111	CE, CUL	822
EVT024	CE, CUL	821	EVT112	CE, CUL	822
EVT025	CE, CUL	821	EVT113	CE, CUL	822
EVT026	CE, CUL	822	EVT114	CE, CUL	822
EVT027	CE, CUL	822	EVT122	CUL	768
EVT028	CE, CUL	821	EVT123	CUL	768
EVT029	CE, CUL	821	EVT124	CUL	768
EVT030	CE, CUL	821	EVT125	CUL	768
EVT031	CE, CUL	821	EVT126	CUL	768
EVT032	CE, CUL	821	EVT127	CUL	768
EVT033	CE, CUL	821	EVT128	CUL	769
EVT034	CUL	822	EVT129	CUL	769
EVT035	CUL	822	EVT130	CUL	769
EVT036	CUL	822	EVT131	CUL	769
EVT037	CUL	822	EVT132	CUL	769
EVT038	CUL	822	EVT133	CUL	769
EVT039	CUL	822	EVT134	CUL	769
EVT040	CE, CUL	824	EVT135	CUL	769
EVT041	CE, CUL	824	EVT136	CUL	769
EVT042	CE, CUL	824	EVT137	CUL	769
EVT043	CE, CUL	824	EVT138	CUL	769
EVT044	CE, CUL	824	EVT139	CUL	769
EVT045	CE, CUL	824	EVT140	CUL	769
EVT046	CE, CUL	823	EVT141	CUL	769
EVT047	CE, CUL	823	EVT142	CUL	813
EVT048	CE, CUL	823	EVT143	CUL	813
EVT049	CE, CUL	823	EVT144	CUL	813
EVT050	CE, CUL	824	EVT145	CUL	813
EVT051	CE, CUL	824	EVT146	CUL	814
EVT052	CUL	824	EVT147	CUL	814
EVT053	CUL	824	EVT148	CUL	814
EVT054	CUL	824	EVT149	CUL	814
EVT055	CUL	824	EVT150	CUL	814
EVT056	CUL	824	EVT151	CUL	814
EVT057	CUL	824	EVT152	CUL	814
EVT058	CE, CUL	825	EVT153	CUL	814
EVT059	CE, CUL	825	EVT154	CUL	814
EVT060	CE, CUL	825	EVT155	CUL	814
EVT061	CE, CUL	825	EVT156	CUL	814
EVT062	CE, CUL	825	EVT157	CUL	814
EVT063	CE, CUL	825	EVT158	CUL	814
EVT064	CE, CUL	770	EVT159	CUL	814
EVT067	CE, CUL	770	EVT160	CUL	815

**Standards and approvals /
list of articles**

Order no.	Approvals	Catalogue page	Order no.	Approvals	Catalogue page
EVT161	CUL	815	EVT243	CUL	821
EVT162	CUL	815	EVT244	CUL	821
EVT163	CUL	815	EVT245	CUL	821
EVT164	CUL	815	EVT246	CUL	821
EVT165	CUL	815	EVT248	CUL	823
EVT166	CUL	815	EVT249	CUL	823
EVT167	CUL	815	EVT250	CUL	823
EVT168	CUL	815	EVT251	CUL	823
EVT169	CUL	815	EVT253	CUL	823
EVT170	CUL	815	EVT254	CUL	823
EVT171	CUL	815	EVT255	CUL	823
EVT172	CUL	815	EVT256	CUL	823
EVT173	CUL	815	EVT257	CUL	823
EVT174	CUL	815	EVT258	CUL	823
EVT175	CUL	816	EVT260	CUL	816
EVT176	CUL	816	EVT261	CUL	817
EVT177	CUL	816	EVT262	CUL	817
EVT178	CUL	817	EVT263	CUL	817
EVT179	CUL	817	EVT265	CUL	817
EVT180	CUL	817	EVT266	CUL	817
EVT181	CUL	817	EVT267	CUL	817
EVT182	CUL	817	EVT268	CUL	817
EVT183	CUL	817	EVT269	CUL	817
EVT184	CUL	818	EVT270	CUL	817
EVT185	CUL	818	EVT279	CUL	816
EVT186	CUL	818	EVT280	CUL	816
EVT187	CUL	818	EVT281	CUL	816
EVT188	CUL	818	EVT283	CUL	816
EVT189	CUL	818	EVT284	CUL	816
EVT190	CUL	818	EVT285	CUL	816
EVT191	CUL	818	EVT286	CUL	816
EVT192	CUL	818	EVT290	CUL	823
EVT193	CUL	818	EVT329	CE, CUL	857
EVT194	CUL	818	EVT330	CE, CUL	857
EVT195	CUL	818	EVT331	CE, CUL	857
EVT196	CUL	818	EVT332	CE, CUL	857
EVT197	CUL	818	EVT333	CE, CUL	857
EVT198	CUL	818	EVT334	CE, CUL	857
EVT199	CUL	819	EVT335	CUL	858
EVT200	CUL	819	EVT336	CUL	858
EVT201	CUL	819	EVT337	CUL	858
EVT203	CUL	816	EVT381	CUL	772
EVT204	CUL	816	EVT382	CUL	772
EVT211	CUL	816	EVT383	CUL	772
EVT236	CUL	820	EVT384	CUL	773
EVT237	CUL	820	EVT385	CUL	773
EVT238	CUL	820	EVT386	CUL	773
EVT239	CUL	820	EVT387	CUL	773
EVT240	CUL	820	EVT388	CUL	773
EVT242	CUL	821	EVT389	CUL	773

Order no.	Approvals	Catalogue page	Order no.	Approvals	Catalogue page
EVT390	CUL	773	EVW034	CE, CUL	811
EVT391	CUL	773	EVW035	CE, CUL	811
EVT392	CUL	773	EVW036	CE, CUL	811
EVT393	CUL	773	EVW037	CE, CUL	811
EVT394	CUL	773	EVW038	CUL	813
EVT395	CUL	773	EVW039	CUL	813
EVT396	CUL	773	EVW041	CUL	813
EVT397	CUL	773	EVW042	CUL	813
EVT398	CUL	774	EVW043	CUL	813
EVT399	CUL	774	EVW044	CUL	813
EVT400	CUL	774	EVW045	CUL	813
EVT401	CUL	774	EVW046	CUL	813
EVT402	CUL	774	EVW047	CUL	813
EVT403	CUL	774	EVW048	CE, CUL	812
EVT404	CUL	774	EVW049	CE, CUL	812
EVT405	CUL	774	EVW050	CE, CUL	812
EVT406	CUL	774	EVW051	CE, CUL	812
EVT407	CUL	774	EVW052	CE, CUL	812
EVT408	CUL	775	EVW053	CE, CUL	812
EVT409	CUL	775	EVW054	CE, CUL	812
EVT410	CUL	775	EVW055	CE, CUL	812
EVT411	CUL	775	EVW056	CE, CUL	812
EVT412	CUL	775	EVW057	CE, CUL	812
EVT461	CUL	774	EVW058	CE, CUL	812
EVT462	CUL	774	EVW059	CE, CUL	812
EVT463	CUL	774	EVW167	CUL	767
EVT464	CUL	774	EVW168	CUL	767
EVW001	CE, CUL	767	EVW169	CUL	767
EVW002	CE, CUL	767	EY1001	CE	422
EVW003	CE, CUL	767	EY1002	CE	422
EVW004	CE, CUL	767	EY1003	CE	422
EVW005	CE, CUL	767	EY1004	CE	422, 431
EVW006	CE, CUL	767	EY1005	CE	423
EVW007	CUL	767	EY1006	CE	423, 431
EVW008	CUL	767	EY1007	CE	423, 431
EVW009	CUL	767	EY1008	CE	423
EVW010	CE, CUL	768	EY1009	CE	423
EVW011	CE, CUL	768	EY1010	CE	423
EVW012	CE, CUL	768	EY1011	CE	424, 432
EVW013	CE, CUL	768	EY1013	CE	424, 432
EVW014	CE, CUL	768	EY1014	CE	424
EVW015	CE, CUL	768	EY1015	CE	424
EVW022	CE, CUL	811	EY2001	CE	424, 431
EVW023	CE, CUL	811	EY2002	CE	424, 431
EVW024	CE, CUL	811	EY2003	CE	424
EVW025	CE, CUL	811	EY2004	CE	424
EVW028	CE, CUL	812	EY2005	CE	425, 432
EVW029	CE, CUL	812	EY3001	CE	423, 431
EVW030	CE, CUL	811	EY3002	CE	423, 431
EVW031	CE, CUL	811	EY3004	CE	423, 431

Standards and approvals / list of articles

Order no.	Approvals	Catalogue page	Order no.	Approvals	Catalogue page
EY3005	CE	423, 431	I7R214	CE, CUL, (CCC)	95
EY3006		423	I7R215	CE, CUL, (CCC)	95
EY3007		423	I7R216	CE, CUL, (CCC)	95
EY3008		423	I7R217	CE, CUL, (CCC)	95
EY3009		423	I85000	CE, CUL, (CCC)	96
EY3010		423	I85001	CE, CUL, (CCC)	96
EY3011		423, 431	I85002	CE, CUL, (CCC)	96
EY3013		424	I85003	CE, CUL, (CCC)	95
EY3098	CE	424, 431	I95045	CE	94
EY3099	CE	424, 431	IA0004	CCC, CE, EAC	90
G1501S	CE, CUL, TÜV Nord	436	IA0027	CCC, CE, EAC	91
G1502S	CE, CUL, TÜV Nord	436	IA0032	CCC, CE, CUL	92
G1503S	CE, CUL, TÜV Nord	436	IA5062	CE, CUL, (CCC)	84
G2001S	CE	436	IA5063	CE, CUL, (CCC)	84
GF711S	CE, CUL, TÜV Nord	405	IA5082	CE, EAC, (CCC)	83
GG505S	CE, CUL, TÜV Nord	404, 441	IA5108	CCC, CE, EAC	84
GG507S	CE, CUL, TÜV Nord	404	IA5122	CCC, CE, CUL	84
GG711S	CE, CUL, TÜV Nord	405	IA5127	CE, CUL, EAC, (CCC)	84
GG712S	CE, CUL, TÜV Nord	405	IB0004	CCC, CE, EAC	90
GG714S	CE, TÜV Nord	404	IB0016	CCC, CE, CUL	92
GG851S	CE, CUL	405	IB0017	CCC, CE, EAC	91
GI505S	CE, CUL, TÜV Nord	404, 441	IB0026	CCC, CE, EAC	90
GI701S	CE, CUL, TÜV Nord	405	IB0027	CCC, CE, EAC	91
GI711S	CE, CUL, TÜV Nord	405	IB5063	CE, CUL, (CCC)	85
GI712S	CE, CUL, TÜV Nord	405	IB5096	CE, EAC, (CCC)	83
GM504S	CE, CUL, TÜV Nord	404, 441	IB5124	CCC, CE, CUL	84
GM505S	CE, CUL, TÜV Nord	404, 441	IB5133	CE, (CCC)	85
GM701S	CE, CUL, TÜV Nord	405	IC0003	CCC, CE, CUL	91
GM705S	CE, CUL, TÜV Nord	405	IC5005	CE, CUL, (CCC)	89
I12001	CE	76	ID0013	CCC, CE, CUL	92
I12003	CE	76	ID0014	CE, CCC	90
I17001	CE, (CCC)	76	ID002A	CE	127
I17003	CE, (CCC)	76	ID0049	CCC, CE	91
I22001	CE	76	ID5005	CE, CUL, (CCC)	89
I22003	CE	76	ID5026	CE, (CCC)	85
I22006	CE	77	ID502A	CE	127
I27001	CE, (CCC)	76	ID503A	CE, IEC	128
I7R201	CE, CUL, (CCC)	95	ID5046	CE, CUL, (CCC)	87
I7R202	CE, CUL, (CCC)	94	ID5055	CE, CUL, (CCC)	86
I7R203	CE, CUL, (CCC)	95	ID5058	CE, (CCC)	87
I7R204	CE, CUL, (CCC)	94	ID5059	CE, CUL, (CCC)	113
I7R205	CE, CUL, (CCC)	95	IE5072	CE, EAC, (CCC)	77
I7R206	CE, CUL, (CCC)	94	IE5090	CE, CUL, EAC, (CCC)	81
I7R207	CE, CUL, (CCC)	95	IE5099	CE, EAC, (CCC)	77
I7R208	CE, CUL, (CCC)	94	IE5121	CE, EAC, (CCC)	77
I7R209	CE, CUL, (CCC)	95	IE5129	CE, EAC, (CCC)	78
I7R210	CE, CUL, (CCC)	94	IE5202	CE, EAC, (CCC)	79
I7R211	CE, CUL, (CCC)	95	IE5203	CE, CUL, EAC, (CCC)	81
I7R212	CE, CUL, (CCC)	94	IE5215	CE, EAC, (CCC)	121
I7R213	CE, CUL, (CCC)	95	IE5222	CE, EAC, (CCC)	79

Order no.	Approvals	Catalogue page	Order no.	Approvals	Catalogue page
IE5238	CE, EAC, (CCC)	79	IF5249	CE, EAC, (CCC)	78
IE5258	CE, CUL, EAC, (CCC)	82	IF5297	CE, EAC, (CCC)	78
IE5287	CE, CUL, EAC, (CCC)	82	IF5313	CCC, CE, EAC	78
IE5288	CE, CUL, EAC, (CCC)	81	IF5329	CE, EAC, (CCC)	78
IE5295	CE, (CCC)	122	IF5345	CE, EAC, (CCC)	78
IE5312	CE, EAC, (CCC)	81	IF5514	CE, EAC, (CCC)	122
IE5327	CE, CUL, EAC, (CCC)	81	IF5594	CE, EAC, (CCC)	122
IE5338	CE, CUL, EAC, (CCC)	82	IF5597	CCC, CE, EAC	79
IE5340	CE, CUL, EAC, (CCC)	82	IF5598	CCC, CE, CUL, EAC	81
IE5343	CE, CUL, EAC, (CCC)	77	IF5644	CCC, CE, EAC	79
IE5344	CE, CUL, EAC, (CCC)	77	IF5645	CCC, CE, EAC	80
IE5345	CE, CUL, (CCC)	77	IF5646	CCC, CE, EAC	80
IE5346	CE, CUL, (CCC)	77	IF5647	CCC, CE, CUL, EAC	81
IE5348	CE, CUL, (CCC)	78	IF5670	CE, CUL, EAC, (CCC)	113
IE5349	CE, CUL, EAC, (CCC)	82	IF5675	CE, CUL, EAC, (CCC)	113
IE5350	CE, CUL, EAC, (CCC)	82	IF5750	CE, CUL, EAC, (CCC)	113
IE5351	CE, CUL, EAC, (CCC)	77	IF5751	CE, CUL, (CCC)	113
IE5352	CE, CUL, (CCC)	77	IF5759	CCC, CE, EAC	122
IE5366	CE, CUL, EAC, (CCC)	82	IF5760	CCC, CE, CUL, EAC	122
IE5367	CE, CUL, EAC, (CCC)	82	IF5796	CE, EAC, (CCC)	122
IE5368	CE, CUL, (CCC)	78	IF5813	CE, EAC, (CCC)	122
IE5369	CE, CUL, (CCC)	78	IF5815	CE, EAC, (CCC)	122
IE5379	CE, (CCC)	81	IF5851	CE, CUL, EAC, (CCC)	122
IE5381	CE, (CCC)	104	IF6028	CE, (CCC)	92
IE5382	CE, (CCC)	104	IF6029	CE, (CCC)	93
IE5390	CE, (CCC)	108	IF6030	CE, (CCC)	92
IE5391	CE, (CCC)	108	IF6031	CE, (CCC)	93
IE9203	CCC, CE	106	IF6074	CE	94
IE9902	CCC, CE	106	IF6123	CE, CUL, EAC	73
IEC200	CE, CUL, EAC, (CCC)	114	IF6124	CE, CUL, EAC	73
IEC201	CE, CUL, EAC, (CCC)	115	IF9222	CCC, CE	106
IEC202	CE, CUL, (CCC)	114	IF9920	CCC, CE	106
IEC203	CE, CUL, (CCC)	114	IF9924	CCC, CE	106
IER200	CE, CUL, (CCC)	117	IFC200	CE, CUL, (CCC)	102
IER201	CE, CUL, (CCC)	117	IFC201	CE, CUL, (CCC)	102
IER203	CE, CUL, (CCC)	115	IFC202	CE, CUL, (CCC)	102
IER204	CE, CUL, (CCC)	116	IFC204	CE, CUL, (CCC)	103
IER206	CE, CUL, (CCC)	116	IFC205	CE, CUL, (CCC)	103
IES200	CE, CUL	109	IFC206	CE, CUL, EAC, (CCC)	103, 108
IES201	CE, CUL	109	IFC207	CE, CUL, EAC, (CCC)	105
IEW200	CE, CUL	109	IFC208	CE, CUL, EAC, (CCC)	104
IEW201	CE, CUL	109	IFC209	CE, CUL, EAC, (CCC)	105, 108
IF0001	CCC, CE, EAC	90	IFC210	CE, CUL, EAC, (CCC)	103, 108
IF0003	CCC, CE, EAC	90	IFC229	CE, EAC, (CCC)	103
IF0005	CCC, CE, EAC	90	IFC230	CE, EAC, (CCC)	103
IF0007	CCC, CE, EAC	90	IFC234	CE, (CCC)	105
IF503A	CE	126	IFC235	CE, (CCC)	105
IF504A	CE	126	IFC237	CE, CUL, EAC, (CCC)	103
IF505A	CE	125	IFC238	CE, CUL, EAC, (CCC)	103
IF5188	CE, EAC, (CCC)	78	IFC239	CE, CUL, (CCC)	106

**Standards and approvals /
list of articles**

Order no.	Approvals	Catalogue page	Order no.	Approvals	Catalogue page
IFC241	CE, CUL, (CCC)	106	IFS248	CE, CUL, EAC	101
IFC243	CE, CUL, (CCC)	106	IFS249	CE, CUL, EAC	100
IFC246	CE, CUL, EAC, (CCC)	107	IFS250	CE, CUL, EAC	101
IFC247	CE, CUL, (CCC)	109, 634	IFS251	CE, CUL, EAC	100
IFC248	CE, CUL, (CCC)	634	IFS252	CE, CUL, EAC	98
IFC258	CE, CUL, (CCC)	114	IFS253	CE, CUL, EAC	98
IFC259	CE, CUL, EAC, (CCC)	108	IFS254	CE, UL, EAC	96
IFC263	CE, CUL, (CCC)	115	IFS255	CE, UL, EAC	96
IFC264	CE, CUL, (CCC)	115	IFS256	CE, UL, EAC	98
IFC266	CE, CUL, (CCC)	114	IFS257	CE, UL, EAC	98
IFC275	CE, CUL	114	IFS258	CE, UL, EAC	96
IFM203	CE, CUL, E1R, EAC, (CCC)	738	IFS259	CE, UL, EAC	96
IFM204	CE, CUL, E1R, EAC, (CCC)	738	IFS260	CE, CUL, EAC	101
IFM205	CE, CUL, E1R, CCC, EAC	737	IFS261	CE, CUL, EAC	101
IFM206	CE, CUL, E1R, CCC, EAC	737	IFS262	CE, CUL, EAC	100
IFM207	CE, CUL, E1R, EAC, (CCC)	737	IFS263	CE, CUL, EAC	100
IFM208	CE, CUL, E1R, EAC, (CCC)	737	IFS280	CE, UL, EAC, (CCC)	96
IFM209	CE, CUL, E1R, CCC, EAC	736	IFS281	CE, UL, EAC, (CCC)	96
IFM210	CE, CUL, E1R, CCC, EAC	736	IFS282	CE, UL, EAC, (CCC)	96
IFR200	CE, CUL, (CCC)	117	IFS283	CE, UL, EAC, (CCC)	96
IFR202	CE, CUL, (CCC)	117	IFS285	CE, CUL	110
IFR203	CE, CUL, (CCC)	115	IFS286	CE, CUL	110
IFR204	CE, CUL, (CCC)	116	IFS289	CE, CUL	109
IFR205	CE, CUL, (CCC)	116	IFS290	CE, CUL, EAC	109
IFR206	CE, (CCC)	116	IFS297	CE, CUL, EC19352004, (CCC)	110
IFR207	CE, CUL	116	IFS298	CE, CUL, EC19352004, EAC, (CCC)	110
IFS200	CE, CUL, (CCC)	73	IFS299	CE, CUL, EC19352004, EAC, (CCC)	110
IFS201	CE, CUL, (CCC)	73	IFS304	CE, CUL, EC19352004, (CCC)	110
IFS204	CE, CUL, (CCC)	74	IFS305	CE, CUL, EC19352004, EAC, (CCC)	110
IFS205	CE, CUL, (CCC)	74	IFS306	CE, CUL, EC19352004, EAC, (CCC)	110
IFS206	CE, CUL, (CCC)	75	IFT200	CE, CUL, EC19352004, FDA, (CCC)	120
IFS207	CE, CUL, (CCC)	75	IFT201	CE, CUL, EC19352004, FDA, (CCC)	121
IFS208	CE, CUL, (CCC)	74	IFT202	CE, CUL, EC19352004, FDA, (CCC)	120
IFS209	CE, CUL, (CCC)	74	IFT203	CE, CUL, EAC, EC19352004, FDA, (CCC)	120
IFS210	CE, CUL, (CCC)	76	IFT204	CE, CUL, EAC, EC19352004, FDA, (CCC)	121
IFS211	CE, CUL, (CCC)	76	IFT205	CE, CUL, EAC, EC19352004, FDA, (CCC)	120
IFS212	CE, CUL, (CCC)	74	IFT206	CE, CUL, EC19352004, FDA, (CCC)	119
IFS213	CE, CUL, EAC, (CCC)	74	IFT207	CE, CUL, EC19352004, FDA, (CCC)	119
IFS214	CE, CUL, EAC, (CCC)	80	IFT208	CE, CUL, EC19352004, FDA, (CCC)	119
IFS215	CE, CUL, EAC, (CCC)	80	IFT209	CE, CUL, EC19352004, FDA, (CCC)	119
IFS216	CE, CUL, (CCC)	80	IFT210	CE, CUL, EC19352004, FDA, (CCC)	120
IFS217	CE, CUL, (CCC)	80	IFT216	CE, CUL, EAC, EC19352004, FDA, (CCC)	120
IFS240	CE, CUL, (CCC)	100	IFT217	CE, CUL, EC19352004, FDA, (CCC)	120
IFS241	CE, CUL, (CCC)	100	IFT240	CE, CUL, EAC, EC19352004, FDA, (CCC)	118
IFS242	CE, CUL, EAC, (CCC)	99	IFT243	CE, EC19352004, FDA, (CCC)	118
IFS243	CE, CUL, EAC, (CCC)	99	IFT244	CE, CUL, EC19352004, FDA, (CCC)	118
IFS244	CE, CUL	100	IFT245	CE, CUL, EAC, EC19352004, FDA, (CCC)	118
IFS245	CE, CUL, EAC	99	IFT246	CE, CUL, EC19352004, FDA, (CCC)	118
IFS246	CE, CUL, EAC	99	IFT257	CE, CUL	117
IFS247	CE, CUL, EAC	99	IFW200	CE, CUL, EAC, (CCC)	111

Order no.	Approvals	Catalogue page	Order no.	Approvals	Catalogue page
IFW201	CE, CUL, EAC, (CCC)	111	IGC204	CE, CUL, (CCC)	103
IFW204	CE, CUL, (CCC)	112	IGC205	CE, CUL, (CCC)	103
IG0005	CCC, CE, CUL, EAC	90	IGC206	CE, CUL, EAC, (CCC)	104
IG0006	CCC, CE, CUL, EAC	90	IGC207	CE, CUL, EAC, (CCC)	105
IG0011	CCC, CE, CUL, EAC	90	IGC208	CE, CUL, EAC, (CCC)	105
IG0012	CCC, CE, EAC	90	IGC209	CE, CUL, EAC, (CCC)	105, 108
IG001A	CE, EAC	126	IGC210	CE, CUL, EAC, (CCC)	103, 108
IG510A	CE	125	IGC220	CE, CUL, EAC, (CCC)	104
IG511A	CE	125	IGC221	CE, CUL, EAC, (CCC)	104
IG512A	CE	126	IGC222	CE, EAC, (CCC)	105
IG513A	CE, EAC	126	IGC223	CE, EAC, (CCC)	105
IG514A	CE	126	IGC224	CE, CUL, EAC, (CCC)	104
IG515A	CE, EAC	126	IGC225	CE, CUL, EAC, (CCC)	104
IG5202	CE, (CCC)	121	IGC232	CE, CUL, EAC, (CCC)	107
IG5221	CE, EAC, (CCC)	78	IGC233	CE, CUL, EAC, (CCC)	107
IG5285	CE, EAC, (CCC)	78	IGC234	CE, CUL, (CCC)	109, 634
IG5397	CE, EAC, (CCC)	78	IGC235	CE, CUL, (CCC)	109, 634
IG5398	CE, EAC, (CCC)	78	IGC248	CE, CUL, (CCC)	114
IG5399	CE, EAC, (CCC)	78	IGC249	CE, CUL, (CCC)	115
IG5401	CE, EAC, (CCC)	78	IGC250	CE, CUL, (CCC)	115
IG5533	CCC, CE, EAC	80	IGC252	CE, CUL, (CCC)	114
IG5593	CCC, CE, EAC	80	IGC258	CE, CUL	114
IG5594	CCC, CE, EAC	80	IGM200	CE, CUL, E1, E1R, EAC, (CCC)	738
IG5595	CCC, CE, CUL, EAC	81	IGM201	CE, CUL, E1, E1R, EAC, (CCC)	738
IG5596	CCC, CE, EAC	80	IGM202	CE, CUL, E1, E1R, EAC, (CCC)	737
IG5597	CCC, CE	81	IGM203	CE, CUL, E1R, EAC, (CCC)	737
IG5602	CE, (CCC)	122	IGM204	CE, CUL, E1, E1R, CCC, EAC	737
IG5647	CE, CUL, (CCC)	113	IGM205	CE, CUL, E1, E1R, CCC, EAC	737
IG5667	CE, CUL, (CCC)	113	IGM206	CE, CUL, E1, E1R, CCC, EAC	736
IG5682	CCC, CE, EAC	106	IGM207	CCC, CE, CUL, E1R, EAC	736
IG5718	CCC, CE	83	IGR200	CE, CUL, (CCC)	117
IG5719	CCC, CE	83	IGR202	CE, CUL, (CCC)	117
IG5772	CCC, CE, CUL	122	IGR203	CE, CUL, (CCC)	115
IG5806	CCC, CE	123	IGR204	CE, CUL, (CCC)	116
IG5813	CE, (CCC)	122	IGR205	CE, CUL, (CCC)	116
IG5846	CE, (CCC)	123	IGR206	CE, (CCC)	116
IG5953	CE, EAC, (CCC)	76	IGR207	CE, CUL	116
IG5954	CE, EAC, (CCC)	76	IGS200	CE, CUL, EAC, (CCC)	73
IG6083	CE, (CCC)	92	IGS201	CE, CUL, EAC, (CCC)	74
IG6084	CE, (CCC)	93	IGS204	CE, CUL, (CCC)	74
IG6086	CE, (CCC)	92	IGS205	CE, CUL, (CCC)	74
IG6087	CE, (CCC)	93	IGS206	CE, CUL, (CCC)	75
IG6119	CE	94	IGS207	CE, CUL, (CCC)	75
IG6614	CE	94	IGS208	CE, CUL, EAC, (CCC)	74
IG6615	CE, CUL, EAC	73	IGS209	CE, CUL, EAC, (CCC)	74
IG6616	CE, CUL, EAC	73	IGS210	CE, CUL, EAC, (CCC)	76
IGC200	CE, CUL, EAC, (CCC)	102	IGS212	CE, CUL, EAC, (CCC)	75
IGC201	CE, CUL, EAC, (CCC)	103	IGS213	CE, CUL, EAC, (CCC)	75
IGC202	CE, CUL, EAC, (CCC)	102	IGS214	CE, CUL, (CCC)	81
IGC203	CE, CUL, EAC, (CCC)	102	IGS216	CE, CUL, EAC, (CCC)	81

Standards and approvals / list of articles

Order no.	Approvals	Catalogue page	Order no.	Approvals	Catalogue page
IGS217	CE, CUL, EAC, (CCC)	81	IGT220	CE, CUL, EAC, EC19352004, FDA, (CCC)	120
IGS232	CE, CUL, (CCC)	100	IGT240	CE, CUL, EAC, EC19352004, FDA, (CCC)	121
IGS233	CE, CUL, (CCC)	100	IGT247	CE, CUL, EAC, EC19352004, FDA, (CCC)	118
IGS234	CE, CUL, EAC, (CCC)	99	IGT248	CE, CUL, EC19352004, FDA, (CCC)	118
IGS235	CE, CUL, EAC, (CCC)	99	IGT249	CE, CUL, EAC, EC19352004, FDA, (CCC)	118
IGS236	CE, CUL	100	IGT250	CE, CUL, EC19352004, FDA, (CCC)	118
IGS237	CE, CUL, EAC	100	IGT258	CE, CUL	117
IGS238	CE, CUL, EAC	99	IGW200	CE, CUL, (CCC)	111
IGS239	CE, CUL, EAC	99	IGW201	CE, CUL, EAC, (CCC)	111
IGS240	CE, CUL, EAC	101	IGW202	CE, CUL, EAC, (CCC)	112
IGS241	CE, CUL, EAC	101	II0005	CCC, CE, EAC	90
IGS242	CE, CUL, EAC	101	II0006	CCC, CE, EAC	91
IGS243	CE, CUL, EAC	101	II0011	CCC, CE, CUL, EAC	91
IGS244	CE, CUL, EAC	98	II0012	CCC, CE, CUL, EAC	91
IGS245	CE, CUL, EAC	98	II001A	CE, EAC	126
IGS246	CE, UL, EAC	97	II502A	CE	126
IGS247	CE, UL, EAC	97	II503A	CE	125
IGS248	CE, UL, EAC	98	II504A	CE, IEC	128
IGS249	CE, UL, EAC	98	II5166	CE, EAC, (CCC)	79
IGS250	CE, UL, EAC	97	II5256	CE, EAC, (CCC)	79
IGS251	CE, UL, EAC	97	II5284	CE, EAC, (CCC)	79
IGS252	CE, CUL, EAC	101	II5300	CE, EAC, (CCC)	79
IGS253	CE, CUL, EAC	102	II5346	CE, EAC, (CCC)	79
IGS254	CE, CUL, EAC	101	II5369	CE, EAC, (CCC)	79
IGS255	CE, CUL, EAC	101	II5436	CCC, CE, EAC	80
IGS269	CE, UL, EAC, (CCC)	97	II5488	CCC, CE, EAC	80
IGS270	CE, UL, EAC, (CCC)	97	II5489	CE, CCC	80
IGS271	CE, UL, EAC, (CCC)	97	II5490	CE, CCC	81
IGS272	CE, UL, EAC, (CCC)	97	II5491	CCC, CE, EAC	80
IGS277	CE, CUL	110	II5492	CE, CCC	82
IGS278	CE, CUL	110	II5493	CCC, CE, EAC	80
IGS279	CE, CUL, EAC	110	II5503	CE, CUL, (CCC)	113
IGS280	CE, CUL, EAC	110	II5689	CE, CUL, (CCC)	122
IGS287	CE, CUL, EC19352004, EAC, (CCC)	111	II5733	CCC, CE	123
IGS288	CE, CUL, EC19352004, EAC, (CCC)	111	II5751	CCC, CE	123
IGS289	CE, CUL, EC19352004, EAC, (CCC)	111	II5776	CE, (CCC)	122
IGS290	CE, CUL, EC19352004, (CCC)	111	II5913	CE, (CCC)	92
IGS291	CE, CUL, EC19352004, (CCC)	111	II5914	CE, (CCC)	93
IGS292	CE, CUL, EC19352004, (CCC)	111	II5916	CE, (CCC)	93
IGT200	CE, CUL, EAC, EC19352004, FDA, (CCC)	120	II5917	CE, (CCC)	93
IGT201	CE, CUL, EAC, EC19352004, FDA, (CCC)	121	II5930	CE, (CCC)	94
IGT202	CE, CUL, EAC, EC19352004, FDA, (CCC)	120	II5961	CE	94
IGT203	CE, CUL, EC19352004, FDA, (CCC)	120	II5973	CE, CUL, EAC	73
IGT204	CE, CUL, EC19352004, FDA, (CCC)	121	II5974	CE, CUL, EAC	73
IGT205	CE, CUL, EC19352004, FDA, (CCC)	120	II200	CE, CUL, (CCC)	104
IGT206	CE, CUL, EC19352004, FDA, (CCC)	119	II201	CE, CUL, (CCC)	104
IGT207	CE, CUL, EC19352004, FDA, (CCC)	119	II206	CE, CUL, (CCC)	104, 108
IGT208	CE, CUL, EC19352004, FDA, (CCC)	119	II207	CE, CUL, (CCC)	104
IGT209	CE, CUL, EC19352004, FDA, (CCC)	119	II208	CE, (CCC)	105
IGT219	CE, CUL, EAC, EC19352004, FDA, (CCC)	120	II209	CE, (CCC)	105

Order no.	Approvals	Catalogue page
IIC210	CE, CUL, (CCC)	104
IIC211	CE, CUL, (CCC)	104
IIC218	CE, CUL, EAC, (CCC)	107
IIC219	CE, CUL, EAC, (CCC)	107
IIC220	CE, CUL, (CCC)	109, 634
IIC221	CE, CUL, (CCC)	109, 634
IIC224	CE, CUL, (CCC)	114
IIC226	CE, CUL, (CCC)	114
IIC233	CE, CUL	114
IIM200	CE, CUL, E1, E1R, (CCC)	738
IIM201	CE, CUL, E1, E1R, (CCC)	738
IIM202	CE, CUL, E1, E1R, (CCC)	737
IIM203	CE, CUL, E1, E1R, (CCC)	737
IIM208	CE, CUL, E1, E1R, CCC	737
IIM209	CE, CUL, E1, E1R, CCC	737
IIM210	CE, CUL, E1, E1R, CCC	737
IIM211	CE, CUL, E1, E1R, CCC	737
IIR200	CE, CUL, (CCC)	117
IIR202	CE, CUL, (CCC)	117
IIR203	CE, CUL, (CCC)	115
IIR204	CE, CUL, (CCC)	116
IIR205	CE, CUL, (CCC)	116
IIR206	CE, (CCC)	116
IIR207	CE, CUL	116
IIS204	CE, CUL, EAC, (CCC)	75
IIS205	CE, CUL, EAC, (CCC)	75
IIS206	CE, CUL, (CCC)	74
IIS207	CE, CUL, (CCC)	74
IIS208	CE, CUL, EAC, (CCC)	75
IIS209	CE, CUL, EAC, (CCC)	75
IIS210	CE, CUL, (CCC)	75
IIS211	CE, CUL, (CCC)	75
IIS226	CE, CUL, (CCC)	100
IIS227	CE, CUL, EAC, (CCC)	100
IIS228	CE, CUL, EAC, (CCC)	99
IIS229	CE, CUL, EAC, (CCC)	99
IIS230	CE, CUL, EAC	100
IIS231	CE, CUL, EAC	100
IIS232	CE, CUL, EAC	99
IIS233	CE, CUL, EAC	99
IIS234	CE, CUL	102
IIS235	CE, CUL, EAC	101
IIS236	CE, CUL, EAC	102
IIS237	CE, CUL, EAC	101
IIS238	CE, CUL, EAC	98
IIS239	CE, CUL, EAC	98
IIS240	CE, UL, EAC	97
IIS241	CE, UL, EAC	97
IIS242	CE, UL, EAC	98
IIS243	CE, UL, EAC	99

Order no.	Approvals	Catalogue page
IIS244	CE, UL, EAC	97
IIS245	CE, UL, EAC	97
IIS246	CE, CUL, EAC	102
IIS247	CE, CUL, EAC	102
IIS248	CE, CUL, EAC	101
IIS249	CE, CUL, EAC	101
IIS263	CE, UL, EAC, (CCC)	98
IIS264	CE, UL, EAC, (CCC)	97
IIS265	CE, UL, EAC, (CCC)	98
IIS266	CE, UL, EAC, (CCC)	98
IIS267	CE, CUL, EAC	110
IIS268	CE, CUL	110
IIS269	CE, CUL, EAC	110
IIS281	CE, CUL, EC19352004, EAC, (CCC)	111
IIS282	CE, CUL, EC19352004, (CCC)	111
IIS283	CE, CUL, EC19352004, EAC, (CCC)	111
IIS284	CE, CUL, EC19352004, (CCC)	111
IIT002	CCC, CE, CUL	119
IIT200	CE, CUL, EC19352004, FDA, (CCC)	121
IIT202	CE, CUL, EC19352004, FDA, (CCC)	120
IIT204	CE, CUL, EC19352004, FDA, (CCC)	120
IIT205	CE, CUL, EC19352004, FDA, (CCC)	121
IIT206	CE, CUL, EC19352004, FDA, (CCC)	119
IIT207	CE, CUL, EC19352004, FDA, (CCC)	119
IIT208	CE, CUL, EC19352004, FDA, (CCC)	119
IIT209	CE, CUL, EC19352004, FDA, (CCC)	119
IIT212	CE, CUL, EC19352004, FDA, (CCC)	121
IIT213	CE, CUL, EC19352004, FDA, (CCC)	121
IIT228	CE, CUL, EC19352004, FDA, (CCC)	118
IIT230	CE, CUL, EC19352004, FDA, (CCC)	118
IIT231	CE, CUL, EAC, EC19352004, FDA, (CCC)	118
IIT232	CE, CUL, EC19352004, FDA, (CCC)	118
IIT243	CE, CUL	117
IIW200	CE, CUL, EAC, (CCC)	112
IIW201	CE, (CCC)	112
IIW202	CE, CUL, EAC, (CCC)	112
IL5002	CE, CUL, EAC, (CCC)	85
IL5003	CE, CUL, EAC, (CCC)	85
IL5004	CE, CUL, EAC, (CCC)	88
IL5005	CE, CUL, EAC, (CCC)	88
IL5020	CE, CUL, EAC, (CCC)	85
IL5022	CE, CUL, (CCC)	85
IM0010	CCC, CE, CUL	92
IM0011	CCC, CE, CUL	92
IM001A	CE	127
IM002A	CE	127
IM0049	CCC, CE	90
IM0053	CCC, CE	91
IM0054	CCC, CE	91
IM5019	CE, CUL, (CCC)	89

Standards and approvals / list of articles

Order no.	Approvals	Catalogue page	Order no.	Approvals	Catalogue page
IM5020	CE, CUL, (CCC)	89	IN5188	CE, EAC, (CCC)	86
IM5037	CCC, CE	89	IN5207	CCC, CE, EAC	86
IM5038	CCC, CE	89	IN5208	CCC, CE, CUL, EAC	86
IM5046	CE, (CCC)	89	IN5212	CE, CUL, EAC, (CCC)	88
IM506A	CE	127	IN5224	CE, (CCC)	326, 588
IM507A	CE	127	IN5225	CE, CUL, (CCC)	326, 588
IM508A	CE	127	IN5230	CE, CUL, EAC, (CCC)	88
IM509A	CE	127	IN5251	CE, (CCC)	326, 588
IM510A	CE	127	IN5285	CE, CUL, (CCC)	326, 588
IM5115	CE, CUL, (CCC)	86	IN5304	CE, (CCC)	326, 588
IM5116	CE, CUL, (CCC)	86	IN5323	CE, (CCC)	326, 588
IM5117	CE, CUL, (CCC)	86	IN5327	CE, CUL, (CCC)	326, 588
IM5118	CE	634, 86	IN5331	CE, (CCC)	326, 588
IM5119	CE, CUL, (CCC)	112, 86	IN5334	CE, CUL, (CCC)	327, 589
IM511A	CE	125	IN5409	CE, (CCC)	327, 589
IM5120	CE, CUL, (CCC)	112, 87	IN5410	CE, (CCC)	589
IM5123	CE, CUL, (CCC)	88	IO5016	CE, (CCC)	107
IM5124	CE, CUL, (CCC)	112, 87	IO5017	CE, (CCC)	107
IM5125	CE, CUL, (CCC)	112, 87	IO5018	CE, (CCC)	107
IM5126	CE, CUL, (CCC)	112, 87	IS5001	CE, CUL, (CCC)	85
IM5127	CE, (CCC)	87	IS5026	CE, CUL, EAC, (CCC)	86
IM5128	CE, CUL, (CCC)	87	IS5031	CE, CUL, (CCC)	85
IM5129	CE, CUL, (CCC)	112, 87	IS5035	CE, CUL, EAC, (CCC)	88
IM512A	CE	125	IS5070	CE, EAC, (CCC)	85
IM5130	CE, CUL, (CCC)	87	IS5071	CE, CUL, (CCC)	88
IM5131	CE, CUL, (CCC)	87	IT5001	CE, EAC, (CCC)	83
IM5132	CE, CUL, EAC, (CCC)	112, 88	IT5021	CE, CUL, (CCC)	84
IM5133	CE, CUL, (CCC)	112, 88	IT5034	CE, CUL, (CCC)	84
IM5134	CE, CUL, (CCC)	88	IT5039	CE, CUL, (CCC)	83
IM5135	CE, CUL, EAC, (CCC)	113, 88	IT5040	CE, CUL, (CCC)	84
IM5136	CE, CUL, (CCC)	88	IT5042	CE, CUL, (CCC)	83
IM5139	CE, CUL, (CCC)	93	IT5044	CE, CUL, (CCC)	84
IM513A	CE	125	IV5004	CE, CUL	89
IM5140	CE, CUL, (CCC)	93	IV5060	CE, CUL	89
IM5141	CE, CUL, (CCC)	93	IW5051	CE, (CCC)	85
IM5142	CE, CUL, (CCC)	93	IW5053	CE, (CCC)	86
IM5172	CE, CUL, EAC	73	IW5058	CE, (CCC)	86
IM5173	CE, CUL, EAC	73	IW5062	CE, (CCC)	89
IN0073	CCC, CE, EAC	91	IW5064	CE, CUL, (CCC)	89
IN0077	CCC, CE, EAC	91	IX5002	CE, (CCC)	329, 591
IN0081	CCC, CE, EAC	91	IX5006	CE, (CCC)	329, 591
IN0085	CCC, CE, EAC	91	IX5010	CE, (CCC)	329, 591
IN0108	CCC, CE, CUL	327, 589	IX5030	CE, (CCC)	329, 591
IN0110	CCC, CE	326, 588	IY5029	CE, (CCC)	79
IN0131	CE, CUL	326, 588	IY5036	CE, CUL, (CCC)	82
IN507A	CE	329, 590	IY5048	CE, CUL, (CCC)	82
IN5121	CE, EAC, (CCC)	85	IY5049	CE, CUL, (CCC)	79
IN5129	CE, EAC, (CCC)	85	IY5051	CE, (CCC)	79
IN512A	CE	329	IY5052	CE, (CCC)	79
IN5186	CE, EAC, (CCC)	86	IZ5026	CE, CUL, (CCC)	83

Order no.	Approvals	Catalogue page	Order no.	Approvals	Catalogue page
IZ5035	CE, CUL, (CCC)	84	KI5083	CE, CUL, EAC	162
IZ5046	CE, CUL, (CCC)	84	KI5085	CE, CUL, EAC	163
IZ5047	CE, CUL, (CCC)	83	KI5087	CE, CUL, EAC	163
IZ5048	CE, CUL, (CCC)	83	KI5300	CE, CUL, EAC	164
IZ5051	CE, (CCC)	83	KI5301	CE, CUL, EAC	164
IZ5052	CE, (CCC)	83	KI5302	CE, CUL, EAC	164
JN2100	CE	368, 735	KI5303	CE, CUL, EAC	164
JN2101	CE	368, 735	KI5304	CE, CUL, EAC	164
JN2200	CE	368	KI5305	CE, CUL, EAC	165
JN2201	CE	368	KI5306	CE, CUL, EAC	165
JN2300	CE	368	KI5307	CE, CUL, EAC	165
JN2301	CE	368	KI5308	CE, CUL, EAC	165
KD0009	CCC, CE	164	KI5309	CE, CUL, EAC	165
KD0012	CCC, CE	163	KI5310	CE, CUL, EAC	165
KD001A	CE	168	KI5311	CE, CUL, EAC	165
KD501A	CE	168	KI6000	CE, CUL, EAC	164
KF5001	CE, CUL, EAC	162	KN5121	CE, (CCC)	162
KF5002	CE, CUL, EAC	162	KQ5100	CE, EAC, UL	165
KF5013	CE, CUL, EAC	162	KQ5101	CE, EAC, UL	166
KF5014	CE, EAC, UL	162	KQ5102	CE, EAC, UL	165
KF5015	CE, EAC, UL	162	KQ6002	CE, CUL, EAC	165
KG0009	CCC, CE	163	KQ6004	CE, CUL, EAC	166
KG0010	CCC, CE	163	KQ6005	CE, CUL, EAC	166
KG0016	CCC, CE, EAC	163	KT5010	CE	169
KG5066	CE, CUL, EAC	162	KT5011	CE	169
KG5069	CE, CUL, EAC	162	KT5012	CE	170
KG5071	CE, CUL, EAC	162	KT5013	CE	170
KG5300	CE	166	KT5102	CE	169
KG5301	CE	166	KT5106	CE	170
KG5302	CE	166	KT5110	CE	170
KG5303	CE	166	KT5111	CE	169
KG5304	CE	166	KT5112	CE	169
KG5305	CE	166	KT5150	CE	170
KG5306	CE, CUL, EAC	167	KT5151	CE	170
KG5307	CE, CUL, EAC	167	KT5309	CE	169
KG5308	CE, CUL, EAC	167	KT5310	CE	170
KG5309	CE, CUL, EAC	167	KT5350	CE	170
KG5310	CE, CUL, EAC	167	KT5351	CE	170
KG5311	CE, CUL, EAC	167	KX5001	CCSAUS, CE, FM	167
KG6000	CE, CUL, EAC	163, 166	LDH100	CE	692
KI000A	CE	168	LDP100	CE	692
KI0016	CCC, CE, CUL	163	LI2141	CE, CUL, EAC, WHG	522
KI001A	CE, EAC	168	LI2142	CE, CUL, EAC, WHG	522
KI0020	CCC, CE, CUL	163	LI2143	CE, CUL, WHG	522
KI0024	CCC, CE, CUL	164	LI2241	CE, CUL, WHG	522
KI0054	CCC, CE, CUL, EAC	163	LI2242	CE, CUL, WHG	522
KI5030	CCSAUS, CE, FM, IEC	167	LI2243	CE, CUL, WHG	522
KI503A	CE, EAC	168	LI5141	CE, CUL, EAC	522
KI505A	CE, EAC	168	LI5142	CE, CUL, EAC	522
KI5082	CE, CUL, EAC	162	LI5143	CE, CUL, EAC	522

Standards and approvals / list of articles

Order no.	Approvals	Catalogue page	Order no.	Approvals	Catalogue page
LI5144	CE, CUL, EAC	522	LT3022	CE, CUL	525
LK1022	CE, CUL	521	LT3023	CE, CUL	525
LK1023	CE, CUL	521	LT3024	CE, CUL	525
LK1024	CE, CUL	521	LT8022	CE, CUL	526
LK1222	CE	520	LT8023	CE, CUL	526
LK1223	CE	520	LT8024	CE, CUL	526
LK1224	CE	520	M9H200	CE, CUL, EAC	183, 739
LK3122	CE, CUL	521	ME5010	CE, CUL, (CCC)	184
LK3123	CE, CUL	521	ME5011	CE, CUL, (CCC)	184
LK3124	CE, CUL	521	ME5015	CE, (CCC)	184
LK7022	CE, CUL	521	MFH200	CE, CUL, EAC	182, 738
LK7023	CE, CUL	521	MFH201	CE, CUL, EAC	182, 738
LK7024	CE, CUL	521	MFH202	CE, CUL, EAC	182, 738
LK8122	CE, CUL	521	MFH203	CE, CUL, EAC	182, 738
LK8123	CE, CUL	521	MFH204	CE, CUL, EAC	182, 739
LK8124	CE, CUL	521	MFH205	CE, CUL, EAC	182
LMC100	CE, CUL	520	MFH206	CE, CUL, EAC	182
LMC110	CE, CUL	520	MFH207	CE, CUL, EAC	182
LMC400	CE, CUL	520	MFH208	CE, CUL, EAC	182
LMC410	CE, CUL	520	MFH209	CE, CUL, EAC	183
LMC500	CE, CUL	520	MFS201	CE, CUL, (CCC)	184
LMC502	CE, CRN, CUL, EAC	520	MFS202	CE, CUL, (CCC)	184
LMC510	CE, CUL	520	MFS209	CE, CUL, (CCC)	183
LMT01A	CE, EC19352004, EHEDG, FDA	524	MFS210	CE, CUL, (CCC)	183
LMT03A	CE, EC19352004, EHEDG, FDA	524	MFS211	CE, CUL, (CCC)	183
LMT04A	CE, EC19352004, EHEDG, FDA	524	MFT202	CE, CUL, (CCC)	185
LMT100	CE, CRN, CUL, EAC, EC19352004, EHEDG, FDA	523	MFT204	CE, CUL, (CCC)	185
LMT102	CE, CRN, CUL, EAC, EC19352004, EHEDG, FDA	523	MGS201	CE, CUL, (CCC)	184
LMT104	CE, CRN, CUL, EAC, EC19352004, EHEDG, FDA	523	MGS202	CE, (CCC)	184
LMT105	CE, CRN, CUL, EAC, EC19352004, EHEDG, FDA	523	MGS204	CE, CUL, (CCC)	183
LMT110	CE, CRN, CUL, EAC, EC19352004, EHEDG, FDA	524	MGS205	CE, CUL, (CCC)	183
LMT121	CE, CRN, CUL, EAC, EC19352004, EHEDG, FDA	524	MGS206	CE, CUL, (CCC)	183
LMT191	CE, CUL, EAC, WHG	523	MGT201	CE, EAC, (CCC)	185
LMT192	CE, CUL, EAC, WHG	523	MGT203	CE, CUL, (CCC)	185
LMT194	CE, CUL, EAC, WHG	523	MK500A	CE	197
LMT195	CE, CUL, EAC, WHG	523	MK501A	CE	197
LMT202	ACS, CE, CUL, EAC, EC19352004, FDA	523	MK502A	CE, IEC	197
LMT292	CE, CUL, EAC, WHG	523	MK503A	CE, (CCC)	197
LMT302	ACS, CE, CUL, EAC, EC19352004, FDA	523	MK5100	CE, CUL, EAC, (CCC)	192
LMT392	CE, CUL, EAC, WHG	523	MK5101	CE, CUL, EAC, (CCC)	192
LR2050	CE, CRN, CUL, EAC	524	MK5102	CE, CUL, EAC, (CCC)	193
LR2350	CE, CRN	525	MK5103	CE, CUL, EAC, (CCC)	192
LR2750	CE, CRN, CUL, EAC, EC19352004, EHEDG, FDA	524	MK5104	CE, CUL, EAC, (CCC)	192
LR3000	CE, CUL	525	MK5105	CE, CUL, EAC, (CCC)	193
LR3300	CE, CUL	525	MK5106	CE, CUL, EAC, (CCC)	192
LR7000	CE, CUL	525	MK5107	CE, CUL, EAC, (CCC)	193
LR7300	CE, CUL	525	MK5108	CE, CUL, EAC, (CCC)	193
LR8000	CE, CUL	525	MK5109	CE, CUL, EAC, (CCC)	193
LR8300	CE, CUL	525	MK5110	CE, CUL, EAC, (CCC)	195
LR9020	CE, CRN, CUL, EAC	525	MK5111	CE, CUL, EAC, (CCC)	195

Order no.	Approvals	Catalogue page	Order no.	Approvals	Catalogue page
MK5112	CE, CUL, EAC, (CCC)	192	MR0119	CCC, CE, CUL, EAC	194
MK5114	CE, CUL, EAC, (CCC)	192	MR0120	CCC, CE, CUL, EAC	194
MK5115	CE, CUL, EAC, (CCC)	192	MR0121	CCC, CE, CUL, EAC	195
MK5117	CE, CUL, EAC, (CCC)	192	MR0122	CCC, CE, CUL, EAC	194
MK5122	CE, CUL, EAC, (CCC)	193	MR0123	CCC, CE, CUL, EAC	195
MK5124	CE, CUL, EAC, (CCC)	192	MR0901	CCC, CE, CUL, EAC	193
MK5128	CE, CUL, EAC, (CCC)	195	MR0902	CCC, CE, CUL, EAC	195
MK5137	CE, CUL, EAC, (CCC)	196	MR500A	CE, IEC	198
MK5138	CE, CUL, EAC, (CCC)	196	MR501A	CE, (CCC)	198
MK5139	CE, CUL, EAC, (CCC)	196	MS5010	CE, CUL, (CCC)	184
MK5140	CE, CUL, EAC, (CCC)	196	MS5011	CE, CUL, (CCC)	184
MK5155	CE, CUL, EAC, (CCC)	196	MS5013	CE, (CCC)	184
MK5156	CE, CUL, EAC, (CCC)	196	MX5000	CE	362
MK5157	CE, CUL, EAC, (CCC)	197	MX5004	CE	361
MK5158	CE, CUL, EAC, (CCC)	197	MX5015	CE, EAC	361
MK5159	CE, CUL, EAC, (CCC)	196	MX5017	CE, EAC	361
MK5161	CE, CUL, EAC, (CCC)	196	MX5050	CE	361
MK5186	CE, CUL, EAC, (CCC)	195	N0030A	CE, CSA, FM, IEC	168, 340
MK5208	CE, EAC, (CCC)	198	N0031A	CE, IEC	128, 168
MK5209	CE, CUL, EAC, (CCC)	199	N0032A	CE, CSA, FM, IEC	128, 168
MK5214	CE, CUL, EAC	198	N0033A	CE, IEC	128, 168
MK5215	CE, CUL, EAC	198	N0530A	CE, IEC	128, 168
MK5300	CE, CUL, EAC, (CCC)	199	N0531A	CE, CSA, FM, IEC	128, 169
MK5301	CE, CUL, EAC, (CCC)	199	N0532A	CE, CSA, FM, IEC	128, 169
MK5302	CE, CUL, EAC, (CCC)	199	N0533A	CE, IEC	128, 169
MK5304	CE, CUL, EAC, (CCC)	199	N0534A	CE, CSA, FM, IEC	128, 169
MK5305	CE, CUL, EAC, (CCC)	199	NE5001	CE, CCSAUS, FM, IEC	123
MK5306	CE, CUL, EAC, (CCC)	199	NF5001	CE, CCSAUS, FM, IEC	123
MK5307	CE, CUL, EAC, (CCC)	199	NF5002	CE, CCSAUS, FM, IEC	123
MK5308	CE, CUL, EAC, (CCC)	200	NF5003	CE, CCSAUS, FM, IEC	123
MK5309	CE, CUL, EAC, (CCC)	200	NF5004	CE, CCSAUS, FM, IEC	123
MK5310	CE, CUL, EAC, (CCC)	200	NF500A	CE, CCSAUS, FM, IEC	124
MK5311	CE, CUL, EAC, (CCC)	200	NF501A	CE, CCSAUS, FM, IEC	124
MK5312	CE, CUL, EAC, (CCC)	200	NG5001	CE, CCSAUS, FM, IEC	123
MK5314	CE, CUL, EAC, (CCC)	200	NG5002	CE, CCSAUS, FM, IEC	123
MK5315	CE, CUL, EAC, (CCC)	200	NG5003	CE, CCSAUS, FM, IEC	123
MK5325	CE, CUL, EAC, (CCC)	200	NG5004	CE, CCSAUS, FM, IEC	124
MK5326	CE, CUL, EAC, (CCC)	201	NG500A	CE, CCSAUS, FM, IEC	124
MK5328	CE, EAC, (CCC)	201	NG501A	CE, CCSAUS, FM, IEC	124
MK5329	CE, EAC, (CCC)	201	NI5001	CE, CCSAUS, FM, IEC	124
MK5330	CE, EAC, (CCC)	201	NI5002	CE, CCSAUS, FM, IEC	124
MK5331	CE, EAC, (CCC)	201	NI5003	CE, CCSAUS, FM, IEC	124
MK5900	CE, CUL, EAC, (CCC)	193	NI5004	CE, CCSAUS, FM, IEC	124
MK5902	CE, CUL, EAC, (CCC)	193	NI500A	CE, CCSAUS, FM, IEC	125
MN5200	CE, (CCC)	184, 739	NI501A	CE, CCSAUS, FM, IEC	125
MR0100	CCC, CE, CUL, EAC	194	NM500A	CE, CCSAUS, FM, IEC	125
MR0101	CCC, CE, CUL, EAC	194	NM501A	CE, CCSAUS, FM, IEC	125
MR0102	CCC, CE, CUL, EAC	194	NN5002	CE, CCSAUS, FM, IEC	124
MR0107	CCC, CE, CUL, EAC	194	NN5008	CE, CCSAUS, FM, IEC	328, 590
MR0117	CCC, CE, CUL, EAC	194	NN5009	CE, CCSAUS, FM, IEC	328, 590

Standards and approvals / list of articles

Order no.	Approvals	Catalogue page	Order no.	Approvals	Catalogue page
NN5011	CE, CCSAUS, FM, IEC	328, 590	O2I353	CE, CUL, (CCC)	679
NN5013	CE, IEC	328, 590	O2I354	CE, CUL, (CCC)	679
NN504A	CE, IEC	328, 590	O2I355	CE, CUL, (CCC)	679
NN505A	CE	328, 590	O2M200	CE, E4	724
NS5002	CCSAUS, CE, FM, IEC	124	O2M201	CE, E4	724
NT5001	CE, CCSAUS, FM, IEC	124	O2M202	CE, E4	724
O1D100	CE, CUL, (CCC)	290	O2M203	CE, E4	724
O1D101	CE, CUL, EAC, (CCC)	284, 290	O2V100	CE, CUL, (CCC)	382
O1D103	CE, CUL, (CCC)	290	O2V101	CE, CUL, (CCC)	382
O1D104	CE, CUL, (CCC)	284, 291	O2V102	CE, CUL, (CCC)	382
O1D105	CE, CUL, (CCC)	290	O2V103	CE, CUL, (CCC)	383
O1D106	CE, CUL, (CCC)	290	O2V104	CE, CUL, (CCC)	382
O1D120	CE, CUL, EAC	291	O2V105	CE, CUL, (CCC)	383
O1D155	CE, CUL, (CCC)	290	O2V120	CE, CUL, (CCC)	382
O1D300	CE, CUL, (CCC)	291, 319	O2V121	CE, CUL, (CCC)	383
O2D220	CE, CUL, (CCC)	383	O2V122	CE, CUL, (CCC)	382
O2D222	CE, CUL, (CCC)	383	O2V123	CE, CUL, (CCC)	383
O2D224	CE, CUL, (CCC)	383	O2V124	CE, CUL, (CCC)	382
O2D225	CE, CUL, (CCC)	383	O2V125	CE, CUL, (CCC)	383
O2D227	CE, CUL, (CCC)	383	O3D200	CE, CUL, (CCC)	388
O2D229	CE, CUL, (CCC)	383	O3D201	CE, CUL, (CCC)	392
O2D902	CE, CUL, (CCC)	397	O3D222	CE, CUL, (CCC)	388
O2D903	CE, CUL, (CCC)	397	O3D223	CE, CUL, (CCC)	392
O2D904	CE, CUL, (CCC)	397	O3D300	CE, CUL	388
O2D905	CE, CUL, (CCC)	398	O3D301	CE, CUL	392
O2D907	CE, (CCC)	398	O3D302	CE, CUL	388
O2D908	CE, (CCC)	398	O3D303	CE, CUL	392
O2D909	CE, (CCC)	398, 679	O3D310	CE	388
O2D911	CE, (CCC)	398	O3D311	CE	392
O2D912	CE, (CCC)	398	O3D312	CE	388
O2D913	CE, (CCC)	398, 679	O3D313	CE	392
O2D915	CE, (CCC)	396	O3M151	CE, E1R	722
O2D917	CE, (CCC)	396, 679	O3M161	CE, E1R	722
O2D919	CE, (CCC)	396	O3M251	CE, E1R	722
O2D920	CE, (CCC)	397	O3M261	CE, E1R	722
O2D921	CE, (CCC)	397	O3M950	CE, E1R	723
O2D922	CE, (CCC)	397, 680	O3M960	CE, E1R	723
O2D923	CE, (CCC)	397	O4E200	CE, CUL, (CCC)	252
O2D924	CE, (CCC)	397	O4E201	CE, CUL, (CCC)	252
O2D925	CE, (CCC)	397, 680	O4E500	CE, CUL, EAC, (CCC)	252
O2D926	CE, (CCC)	397	O4E501	CE, CUL, (CCC)	252
O2I300	CE, CUL, (CCC)	678	O4H200	CE, CUL, (CCC)	252
O2I301	CE, CUL, (CCC)	678	O4H201	CE, CUL, (CCC)	252
O2I302	CE, CUL, (CCC)	678	O4H500	CE, CUL, EAC, (CCC)	253
O2I303	CE, CUL, (CCC)	678	O4H501	CE, CUL, (CCC)	253
O2I304	CE, CUL, (CCC)	678	O4P200	CE, CUL, (CCC)	252
O2I305	CE, CUL, (CCC)	679	O4P201	CE, CUL, (CCC)	252
O2I350	CE, CUL, (CCC)	679	O4P500	CE, CUL, EAC, (CCC)	253
O2I351	CE, CUL, (CCC)	679	O4P501	CE, CUL, (CCC)	253
O2I352	CE, CUL, (CCC)	679	O4S200	CE, CUL, (CCC)	251

Order no.	Approvals	Catalogue page
O4S500	CE, CUL, EAC, (CCC)	252
O4S501	CE, CUL, (CCC)	252
O5C500	CE, CUL, (CCC)	318
O5D100	CE, CUL, EAC	289
O5D101	CE, CUL	289
O5D102	CE, CUL	289
O5D150	CE, CUL	289
O5D151	CE, CUL	290
O5E200	CE, CUL, (CCC)	249
O5E500	CE, CUL, EAC, (CCC)	249
O5E501	CE, CUL, (CCC)	249
O5E502	CE, CUL, (CCC)	250
O5E51A	CE, (CCC)	250
O5E700	CE, CUL, (CCC)	284
O5G500	CE, CUL, (CCC)	318
O5H200	CE, CUL, (CCC)	249
O5H500	CE, CUL, EAC, (CCC)	250
O5H501	CE, CUL, EAC, (CCC)	250
O5H503	CE, CUL, (CCC)	250
O5H504	CE, CUL, (CCC)	250
O5H51A	CE, (CCC)	251
O5H700	CE, CUL, (CCC)	284
O5K500	CE, CUL, (CCC)	318
O5P200	CE, CUL, (CCC)	249
O5P201	CE, CUL, (CCC)	249
O5P500	CE, CUL, EAC, (CCC)	250
O5P501	CE, CUL, (CCC)	250
O5P502	CE, CUL, (CCC)	250
O5P51A	CE, (CCC)	251
O5P700	CE, CUL, (CCC)	284
O5S200	CE, CUL, (CCC)	249
O5S500	CE, CUL, EAC, (CCC)	249
O5S501	CE, CUL, (CCC)	249
O5S51A	CE, (CCC)	250
O5S700	CE, CUL, (CCC)	283
O6E200	CE, CUL, EAC, (CCC)	239
O6E201	CE, CUL, EAC, (CCC)	240
O6E202	CE, CUL, EAC, (CCC)	240
O6E203	CE, CUL, EAC, (CCC)	240
O6E204	CE, CUL, EAC, (CCC)	239
O6E205	CE, CUL, EAC, (CCC)	240
O6E206	CE, CUL, EAC, (CCC)	240
O6E207	CE, CUL, EAC, (CCC)	240
O6E215	CE, CUL, EAC, (CCC)	240
O6E216	CE, CUL, EAC, (CCC)	240
O6E300	CE, CUL, EAC, (CCC)	243
O6E301	CE, CUL, EAC, (CCC)	243
O6E302	CE, CUL, EAC, (CCC)	244
O6E303	CE, CUL, EAC, (CCC)	244
O6E304	CE, CUL, EAC, (CCC)	244

Order no.	Approvals	Catalogue page
O6E305	CE, CUL, EAC, (CCC)	244
O6E306	CE, CUL, EAC, (CCC)	244
O6E307	CE, CUL, EAC, (CCC)	245
O6E309	CE, CUL, EAC, (CCC)	244
O6E400	CE, CUL, EAC	248
O6E401	CE, CUL, EAC	248
O6H200	CE, CUL, EAC, (CCC)	240
O6H201	CE, CUL, EAC, (CCC)	241
O6H202	CE, CUL, EAC, (CCC)	241
O6H203	CE, CUL, EAC, (CCC)	241
O6H204	CE, CUL, EAC, (CCC)	241
O6H205	CE, CUL, EAC, (CCC)	241
O6H206	CE, CUL, EAC, (CCC)	241
O6H207	CE, CUL, EAC, (CCC)	241
O6H210	CE, CUL, EAC	246
O6H211	CE, CUL, EAC	246
O6H212	CE, CUL, EAC	246
O6H213	CE, CUL, EAC	246
O6H214	CE, CUL, EAC	246
O6H300	CE, CUL, EAC, (CCC)	245
O6H301	CE, CUL, EAC, (CCC)	245
O6H302	CE, CUL, EAC, (CCC)	245
O6H303	CE, CUL, EAC, (CCC)	245
O6H304	CE, CUL, EAC, (CCC)	245
O6H305	CE, CUL, EAC, (CCC)	245
O6H306	CE, CUL, EAC, (CCC)	245
O6H307	CE, CUL, EAC, (CCC)	245
O6H309	CE, CUL, EAC, (CCC)	245
O6H310	CE, CUL, EAC, (CCC)	246
O6H400	CE, CUL, EAC	248
O6H401	CE, CUL, EAC	248
O6P200	CE, CUL, EAC, (CCC)	241
O6P201	CE, CUL, EAC, (CCC)	241
O6P202	CE, CUL, EAC, (CCC)	241
O6P203	CE, CUL, EAC, (CCC)	242
O6P204	CE, CUL, EAC, (CCC)	242
O6P205	CE, CUL, EAC, (CCC)	242
O6P206	CE, CUL, EAC, (CCC)	242
O6P207	CE, CUL, EAC, (CCC)	242
O6P300	CE, CUL, EAC, (CCC)	246
O6P301	CE, CUL, EAC, (CCC)	246
O6P302	CE, CUL, EAC, (CCC)	246
O6P303	CE, CUL, EAC, (CCC)	246
O6P304	CE, CUL, EAC, (CCC)	246
O6P305	CE, CUL, EAC, (CCC)	246
O6P306	CE, CUL, EAC, (CCC)	247
O6P307	CE, CUL, EAC, (CCC)	247
O6P309	CE, CUL, EAC, (CCC)	247
O6P310	CE, CUL, EAC, (CCC)	247
O6P400	CE, CUL, EAC	248

Standards and approvals / list of articles

Order no.	Approvals	Catalogue page	Order no.	Approvals	Catalogue page
O6P401	CE, CUL, EAC	248	O7P201	CE, UL, (CCC)	237
O6S200	CE, CUL, EAC, (CCC)	239	O7P202	CE, UL, (CCC)	237
O6S201	CE, CUL, EAC, (CCC)	240	O7P203	CE, UL, (CCC)	237
O6S202	CE, CUL, EAC, (CCC)	240	O7S200	CE, UL, (CCC)	236
O6S203	CE, CUL, EAC, (CCC)	242	O8E200	CE	236
O6S215	CE, CUL, EAC, (CCC)	242	O8E201	CE	236
O6S300	CE, CUL, EAC, (CCC)	243	O8E202	CE	235
O6S301	CE, CUL, EAC, (CCC)	244	O8E203	CE	235
O6S302	CE, CUL, EAC, (CCC)	244	O8E204	CE	236
O6S303	CE, CUL, EAC, (CCC)	244	O8E205	CE	236
O6S305	CE, CUL, EAC, (CCC)	244	O8H200	CE, EAC	233
O6S400	CE, CUL, EAC	248	O8H201	CE, EAC	233
O6T200	CE, CUL, EAC, (CCC)	242	O8H202	CE, EAC	233
O6T201	CE, CUL, EAC, (CCC)	242	O8H203	CE, EAC	234
O6T202	CE, CUL, EAC, (CCC)	242	O8H204	CE, EAC	233
O6T203	CE, CUL, EAC, (CCC)	243	O8H205	CE, EAC	234
O6T204	CE, CUL, EAC, (CCC)	243	O8H206	CE, EAC	233
O6T205	CE, CUL, EAC, (CCC)	243	O8H207	CE, EAC	234
O6T206	CE, CUL, EAC, (CCC)	243	O8H208	CE, EAC	233
O6T207	CE, CUL, EAC, (CCC)	243	O8H209	CE, EAC	234
O6T215	CE, CUL, EAC, (CCC)	243	O8H210	CE, EAC	233
O6T216	CE, CUL, EAC, (CCC)	243	O8H211	CE, EAC	234
O6T300	CE, CUL, EAC, (CCC)	247	O8H212	CE, EAC	233
O6T301	CE, CUL, EAC, (CCC)	247	O8H213	CE, EAC	234
O6T302	CE, CUL, EAC, (CCC)	247	O8H214	CE, EAC	233
O6T303	CE, CUL, EAC, (CCC)	247	O8H215	CE, EAC	234
O6T304	CE, CUL, EAC, (CCC)	247	O8H216	CE, EAC	233
O6T305	CE, CUL, EAC, (CCC)	247	O8H217	CE, EAC	234
O6T306	CE, CUL, EAC, (CCC)	247	O8H218	CE, EAC	233
O6T307	CE, CUL, EAC, (CCC)	248	O8H219	CE, EAC	234
O6T309	CE, CUL, EAC, (CCC)	248	O8H220	CE, EAC	233
O6T400	CE, CUL, EAC	248	O8H221	CE, EAC	234
O6T401	CE, CUL, EAC	248	O8H222	CE, EAC	233
O7E200	CE, UL, (CCC)	236	O8H223	CE, EAC	234
O7E201	CE, UL, (CCC)	236	O8P200	CE	235
O7E202	CE, UL, (CCC)	236	O8P201	CE	235
O7E203	CE, UL, (CCC)	236	O8P202	CE	235
O7H200	CE, UL, (CCC)	237	O8P203	CE	235
O7H201	CE, UL, (CCC)	237	O8P204	CE	235
O7H202	CE, UL, (CCC)	237	O8P205	CE	235
O7H203	CE, UL, (CCC)	237	O8S200	CE	236
O7H204	CE, UL, (CCC)	237	O8S201	CE	235
O7H205	CE, UL, (CCC)	237	O8S202	CE	236
O7H206	CE, UL, (CCC)	237	O8T200	CE	235
O7H207	CE, UL, (CCC)	237	O8T201	CE	235
O7H208	CE, UL, (CCC)	237	O8T202	CE	234
O7H209	CE, UL, (CCC)	237	O8T203	CE	234
O7H210	CE, UL, (CCC)	237	O8T204	CE	235
O7H211	CE, UL, (CCC)	237	O8T205	CE	235
O7P200	CE, UL, (CCC)	237	OA0101	CCC, CE, CUL	251

Order no.	Approvals	Catalogue page
OA0102	CCC, CE, CUL	251
OA0106	CCC, CE, CUL	251
OA0108	CCC, CE, CUL	251
OBF500	CE, CUL, (CCC)	300
OBF501	CE, CUL, (CCC)	300
OBF502	CE, CUL, (CCC)	300
OBF503	CE, CUL, (CCC)	300
OF5010	CE, CUL, (CCC)	223
OF5012	CE, CUL, EAC, (CCC)	224
OF5014	CE, CUL, (CCC)	223
OF5016	CE, CUL, EAC, (CCC)	223
OF5018	CE, CUL, (CCC)	223
OF5019	CE, CUL, (CCC)	223
OF5021	CE, CUL, EAC, (CCC)	223
OF5022	CE, CUL, EAC, (CCC)	223
OF5024	CE, CUL, (CCC)	223
OF5025	CE, CUL, EAC, (CCC)	223
OF5026	CE, CUL, (CCC)	224
OF5027	CE, CUL, EAC, (CCC)	224
OF5032	CE, CUL, (CCC)	224
OF5048	CE, CUL, (CCC)	223
OF5049	CE, CUL, (CCC)	224
OF5050	CE, CUL, (CCC)	223
OF5051	CE, CUL, (CCC)	223
OF5060	CE, CUL, (CCC)	224
OF5062	CE, CUL, (CCC)	223
OG0028	CCC, CE	225
OG0029	CCC, CE	225
OG0030	CCC, CE, CUL	225
OG0031	CCC, CE	225
OG0032	CCC, CE	226
OG0033	CCC, CE	226
OG0034	CCC, CE	227
OG0035	CCC, CE	227
OG0038	CCC, CE	225
OG0039	CCC, CE	225
OG0040	CCC, CE	227
OG0041	CCC, CE	227
OG0043	CCC, CE	226
OG0044	CCC, CE	226
OG5123	CE, CUL, (CCC)	230
OG5124	CE, CUL, (CCC)	231
OG5125	CE, CUL, (CCC)	230
OG5126	CE, CUL, (CCC)	230
OG5127	CE, CUL, (CCC)	230
OG5128	CE, CUL, (CCC)	230
OG5129	CE, CUL, (CCC)	230
OGE100	CE, CUL, (CCC)	224
OGE101	CE, CUL, (CCC)	224
OGE102	CE, CUL, (CCC)	224

Order no.	Approvals	Catalogue page
OGE103	CE, CUL, (CCC)	224
OGE200	CE, CUL, (CCC)	225
OGE201	CE, CUL, (CCC)	225
OGE280	CE, CUL, (CCC)	231
OGE281	CE, CUL, (CCC)	231
OGE282	CE, CUL, (CCC)	231
OGE300	CE, CUL, EAC, (CCC)	229
OGE301	CE, CUL, EAC, (CCC)	229
OGE302	CE, CUL, (CCC)	228
OGE303	CE, CUL, (CCC)	228
OGE380	CE, CUL, (CCC)	232
OGE381	CE, CUL, (CCC)	232
OGE382	CE, CUL, (CCC)	232
OGE500	CE, CUL, EAC, (CCC)	227
OGE502	CE, CUL, (CCC)	227
OGE700	CE, CUL, (CCC)	282
OGE701	CE, CUL, (CCC)	282
OGH200	CE, CUL, (CCC)	226
OGH280	CE, CUL, (CCC)	231
OGH281	CE, CUL, (CCC)	231
OGH282	CE, CUL, (CCC)	232
OGH283	CE, CUL, (CCC)	232
OGH300	CE, CUL, EAC, (CCC)	230
OGH301	CE, CUL, EAC, (CCC)	230
OGH302	CE, CUL, (CCC)	230
OGH303	CE, CUL, (CCC)	230
OGH304	CE, CUL, EAC, (CCC)	230
OGH305	CE, CUL, EAC, (CCC)	230
OGH306	CE, CUL, (CCC)	229
OGH307	CE, CUL, (CCC)	229
OGH308	CE, CUL, (CCC)	229
OGH309	CE, CUL, (CCC)	229
OGH310	CE, CUL, (CCC)	229
OGH311	CE, CUL, (CCC)	229
OGH380	CE, CUL, (CCC)	232
OGH381	CE, CUL, (CCC)	232
OGH382	CE, CUL, (CCC)	232
OGH383	CE, CUL, (CCC)	232
OGH500	CE, CUL, EAC, (CCC)	228
OGH501	CE, CUL, (CCC)	228
OGH502	CE, CUL, (CCC)	228
OGH504	CE, CUL, (CCC)	228
OGH580	CE, CUL, (CCC)	232
OGH581	CE, CUL, (CCC)	232
OGH700	CE, CUL, (CCC)	282
OGP100	CE, CUL, (CCC)	225
OGP101	CE, CUL, (CCC)	225
OGP102	CE, CUL, (CCC)	225
OGP103	CE, CUL, (CCC)	225
OGP200	CE, CUL, (CCC)	226

**Standards and approvals /
list of articles**

Order no.	Approvals	Catalogue page	Order no.	Approvals	Catalogue page
OGP201	CE, CUL, (CCC)	226	OJ5138	CE, CUL, (CCC)	282
OGP280	CE, CUL, (CCC)	231	OJ5139	CE, CUL, (CCC)	282
OGP281	CE, CUL, (CCC)	231	OJ5141	CE, CUL, (CCC)	282
OGP282	CE, CUL, (CCC)	231	OJ5142	CE, CUL, (CCC)	282
OGP283	CE, CUL, (CCC)	231	OJ5144	CE, CUL, (CCC)	239
OGP300	CE, CUL, EAC, (CCC)	229	OJ5148	CE, CUL, (CCC)	239
OGP301	CE, CUL, EAC, (CCC)	229	OJ5152	CE, CUL, (CCC)	283
OGP302	CE, CUL, (CCC)	229	OJ5154	CE, CUL, (CCC)	283
OGP303	CE, CUL, (CCC)	229	OJ5158	CE, CUL, (CCC)	283
OGP500	CE, CUL, EAC, (CCC)	228	OJ5185	CE, CUL, (CCC)	318
OGP502	CE, CUL, (CCC)	227	OJ5186	CE, CUL, (CCC)	318
OGP503	CE, CUL, (CCC)	228	OJ5189	CE, CUL, (CCC)	318
OGP700	CE, CUL, (CCC)	282	OJ5190	CE, CUL, (CCC)	318
OGP701	CE, CUL, (CCC)	282	OJ5191	CE, CUL, (CCC)	318
OGS100	CE, CUL, (CCC)	224	OJE200	CE, CUL, (CCC)	238
OGS200	CE, CUL, (CCC)	225	OJH200	CE, CUL, (CCC)	238
OGS280	CE, CUL, (CCC)	231	OJP200	CE, CUL, (CCC)	238
OGS300	CE, CUL, EAC, (CCC)	229	OJR200	CE, CUL, (CCC)	238
OGS301	CE, CUL, (CCC)	228	OJS200	CE, CUL, (CCC)	238
OGS380	CE, CUL, (CCC)	232	OK5001	CE, CUL	304
OGS500	CE, CUL, EAC, (CCC)	227	OK5008	CE, CUL	304
OGS501	CE, CUL, (CCC)	227	OO5000	CE, CUL, (CCC)	300
OGS700	CE, CUL, (CCC)	282	OO5001	CE, CUL, (CCC)	300
OGS701	CE, CUL, (CCC)	282	OO5002	CE, CUL, (CCC)	300
OGT100	CE, CUL, (CCC)	226	OO5003	CE, CUL, (CCC)	300
OGT101	CE, CUL, (CCC)	226	OO5004	CE, CUL, (CCC)	304
OGT102	CE, CUL, (CCC)	226	OO5005	CE, CUL, (CCC)	304
OGT103	CE, CUL, (CCC)	226	OO5006	CE, CUL, (CCC)	304
OGT200	CE, CUL, (CCC)	226	OO5007	CE, CUL, (CCC)	304
OGT500	CE, CUL, EAC, (CCC)	228	OPL200	CE, CUL, (CCC)	277
OID200	CE, CUL	288	OPL201	CE, CUL, (CCC)	277
OID201	CE, CUL	288	OPL202	CE, CUL, (CCC)	277
OID202	CE, CUL	288	OPL203	CE, CUL, (CCC)	277
OID204	CE, CUL	289	OPU200	CE, (CCC)	276
OID250	CE, CUL	289	OPU201	CE, CUL, (CCC)	276
OID251	CE, CUL	289	OPU202	CE, CUL, (CCC)	276
OID254	CE, CUL	289	OPU203	CE, CUL, (CCC)	276
OJ5014	CE, CUL, (CCC)	283	OPU204	CE, CUL, (CCC)	276
OJ5100	CE, CUL, (CCC)	239	OPU205	CE, CUL, (CCC)	276
OJ5104	CE, CUL, (CCC)	239	OPU207	CE, (CCC)	276
OJ5108	CE, CUL, (CCC)	239	OPU208	CE, CUL, (CCC)	276
OJ5109	CE, CUL, (CCC)	239	OPU209	CE, CUL, (CCC)	276
OJ5114	CE, CUL, (CCC)	283	OPU210	CE, CUL, (CCC)	276
OJ5116	CE, CUL, (CCC)	283	OPU211	CE, CUL, (CCC)	276
OJ5117	CE, (CCC)	283	OPU700	CE, CUL, (CCC)	277
OJ5122	CE, CUL, (CCC)	238	OPU701	CE, CUL, (CCC)	277
OJ5126	CE, CUL, (CCC)	238	OPU702	CE, CUL, (CCC)	277
OJ5130	CE, CUL, (CCC)	238	OU5001	CE, CUL	304
OJ5131	CE, CUL, (CCC)	238	OU5002	CE, CUL	305
OJ5136	CE, CUL, (CCC)	283	OU5043	CE, CUL	305

Order no.	Approvals	Catalogue page	Order no.	Approvals	Catalogue page
OY001S	CE, CUL, (CCC)	409	OY069S	CE, CUL, (CCC)	412
OY002S	CE, CUL, (CCC)	409	OY070S	CE, CUL, (CCC)	412
OY003S	CE, CUL, (CCC)	409	OY072S	CE, CUL, (CCC)	418
OY004S	CE, CUL, (CCC)	409	OY073S	CE, CUL, (CCC)	418
OY005S	CE, CUL, (CCC)	409	OY074S	CE, CUL, (CCC)	418
OY006S	CE, CUL, (CCC)	409	OY075S	CE, CUL, (CCC)	418
OY007S	CE, CUL, (CCC)	409	OY076S	CE, CUL, (CCC)	418
OY008S	CE, CUL, (CCC)	409	OY077S	CE, CUL, (CCC)	418
OY009S	CE, CUL, (CCC)	409	OY078S	CE, CUL, (CCC)	418
OY010S	CE, CUL, (CCC)	409	OY079S	CE, CUL, (CCC)	418
OY011S	CE, CUL, (CCC)	409	OY080S	CE, CUL, (CCC)	418
OY031S	CE, CUL, (CCC)	416	OY082S	CE, CUL, (CCC)	413
OY032S	CE, CUL, (CCC)	416	OY083S	CE, CUL, (CCC)	413
OY033S	CE, CUL, (CCC)	416	OY084S	CE, CUL, (CCC)	413
OY034S	CE, CUL, (CCC)	416	OY085S	CE, CUL, (CCC)	414
OY035S	CE, CUL, (CCC)	416	OY086S	CE, CUL, (CCC)	414
OY036S	CE, CUL, (CCC)	416	OY087S	CE, CUL, (CCC)	414
OY037S	CE, CUL, (CCC)	416	OY088S	CE, CUL, (CCC)	414
OY038S	CE, CUL, (CCC)	416	OY089S	CE, CUL, (CCC)	414
OY039S	CE, CUL, (CCC)	416	OY090S	CE, CUL, (CCC)	414
OY040S	CE, CUL, (CCC)	416	OY094S	CE, CUL, (CCC)	418
OY041S	CE, CUL, (CCC)	410	OY095S	CE, CUL, (CCC)	418
OY042S	CE, CUL, (CCC)	410	OY096S	CE, CUL, (CCC)	418
OY043S	CE, CUL, (CCC)	410	OY097S	CE, CUL, (CCC)	418
OY044S	CE, CUL, (CCC)	411	OY098S	CE, CUL, (CCC)	419
OY045S	CE, CUL, (CCC)	411	OY099S	CE, CUL, (CCC)	419
OY046S	CE, CUL, (CCC)	411	OY100S	CE, CUL, (CCC)	419
OY047S	CE, CUL, (CCC)	411	OY104S	CE, CUL, (CCC)	415
OY048S	CE, CUL, (CCC)	411	OY105S	CE, CUL, (CCC)	415
OY049S	CE, CUL, (CCC)	411	OY106S	CE, CUL, (CCC)	415
OY050S	CE, CUL, (CCC)	411	OY107S	CE, CUL, (CCC)	415
OY051S	CE, CUL, (CCC)	417	OY108S	CE, CUL, (CCC)	415
OY052S	CE, CUL, (CCC)	417	OY109S	CE, CUL, (CCC)	415
OY053S	CE, CUL, (CCC)	417	OY110S	CE, CUL, (CCC)	415
OY054S	CE, CUL, (CCC)	417	OY111S	CE, CUL, (CCC)	428
OY055S	CE, CUL, (CCC)	417	OY112S	CE, CUL, (CCC)	428
OY056S	CE, CUL, (CCC)	417	OY113S	CE, CUL, (CCC)	428
OY057S	CE, CUL, (CCC)	417	OY114S	CE, CUL, (CCC)	429
OY058S	CE, CUL, (CCC)	417	OY115S	CE, CUL, (CCC)	429
OY059S	CE, CUL, (CCC)	417	OY116S	CE, CUL, (CCC)	429
OY060S	CE, CUL, (CCC)	417	OY120S	CE, CUL, (CCC)	429
OY061S	CE, CUL, (CCC)	412	OY121S	CE, CUL, (CCC)	429
OY062S	CE, CUL, (CCC)	412	OY122S	CE, CUL, (CCC)	429
OY063S	CE, CUL, (CCC)	412	OY204S	CE, CUL, (CCC)	415
OY064S	CE, CUL, (CCC)	412	OY205S	CE, CUL, (CCC)	415
OY065S	CE, CUL, (CCC)	412	OY206S	CE, CUL, (CCC)	415
OY066S	CE, CUL, (CCC)	412	OY207S	CE, CUL, (CCC)	416
OY067S	CE, CUL, (CCC)	412	OY208S	CE, CUL, (CCC)	416
OY068S	CE, CUL, (CCC)	412	OY209S	CE, CUL, (CCC)	416
			OY210S	CE, CUL, (CCC)	416

Standards and approvals / list of articles

Order no.	Approvals	Catalogue page	Order no.	Approvals	Catalogue page
OY221S	CE, CUL, (CCC)	410	OY432S	CE, CUL, (CCC)	420
OY222S	CE, CUL, (CCC)	410	OY433S	CE, CUL, (CCC)	420
OY223S	CE, CUL, (CCC)	410	OY434S	CE, CUL, (CCC)	420
OY224S	CE, CUL, (CCC)	410	OY435S	CE, CUL, (CCC)	420
OY225S	CE, CUL, (CCC)	410	OY436S	CE, CUL, (CCC)	420
OY226S	CE, CUL, (CCC)	410	OY437S	CE, CUL, (CCC)	420
OY227S	CE, CUL, (CCC)	410	OY438S	CE, CUL, (CCC)	420
OY228S	CE, CUL, (CCC)	410	OY439S	CE, CUL, (CCC)	421
OY229S	CE, CUL, (CCC)	410	OY440S	CE, CUL, (CCC)	421
OY230S	CE, CUL, (CCC)	410	OY441S	CE, CUL, (CCC)	419
OY241S	CE, CUL, (CCC)	411	OY442S	CE, CUL, (CCC)	419
OY242S	CE, CUL, (CCC)	411	OY443S	CE, CUL, (CCC)	419
OY243S	CE, CUL, (CCC)	411	OY444S	CE, CUL, (CCC)	419
OY244S	CE, CUL, (CCC)	411	OY445S	CE, CUL, (CCC)	419
OY245S	CE, CUL, (CCC)	411	OY446S	CE, CUL, (CCC)	420
OY246S	CE, CUL, (CCC)	411	OY447S	CE, CUL, (CCC)	420
OY247S	CE, CUL, (CCC)	411	OY448S	CE, CUL, (CCC)	420
OY248S	CE, CUL, (CCC)	412	OY449S	CE, CUL, (CCC)	420
OY249S	CE, CUL, (CCC)	412	OY450S	CE, CUL, (CCC)	420
OY250S	CE, CUL, (CCC)	412	OY453S	CE, CUL, (CCC)	420
OY261S	CE, CUL, (CCC)	413	OY801S	CE, CUL, (CCC)	421
OY262S	CE, CUL, (CCC)	413	OY804S	CE, CUL, (CCC)	421
OY263S	CE, CUL, (CCC)	413	OY805S	CE, CUL, (CCC)	421
OY264S	CE, CUL, (CCC)	413	OY806S	CE, CUL, (CCC)	421
OY265S	CE, CUL, (CCC)	413	OY807S	CE, CUL, (CCC)	421
OY266S	CE, CUL, (CCC)	413	OY808S	CE, CUL, (CCC)	421
OY267S	CE, CUL, (CCC)	413	OY815S	CE, CUL, (CCC)	421
OY268S	CE, CUL, (CCC)	413	OY816S	CE, CUL, (CCC)	421
OY269S	CE, CUL, (CCC)	413	OY817S	CE, CUL, (CCC)	421
OY270S	CE, CUL, (CCC)	413	OY818S	CE, CUL, (CCC)	422
OY282S	CE, CUL, (CCC)	414	OY819S	CE, CUL, (CCC)	422
OY283S	CE, CUL, (CCC)	414	OY825S	CE, CUL, (CCC)	422
OY284S	CE, CUL, (CCC)	414	OY826S	CE, CUL, (CCC)	422
OY285S	CE, CUL, (CCC)	414	OY827S	CE, CUL, (CCC)	422
OY286S	CE, CUL, (CCC)	414	OY828S	CE, CUL, (CCC)	422
OY287S	CE, CUL, (CCC)	414	OY829S	CE, CUL, (CCC)	422
OY288S	CE, CUL, (CCC)	414	OY901S	CE, CUL, (CCC)	430
OY289S	CE, CUL, (CCC)	414	OY902S	CE, CUL, (CCC)	430
OY290S	CE, CUL, (CCC)	415	OY903S	CE, CUL, (CCC)	430
OY300S	CE, CUL, (CCC)	417	OY951S	CE, CUL, (CCC)	430
OY403S	CE, CUL, (CCC)	419	OY952S	CE, CUL, (CCC)	430
OY405S	CE, CUL, (CCC)	419	OY953S	CE, CUL, (CCC)	430
OY407S	CE, CUL, (CCC)	419	PA3020	CE, CUL, EAC	463
OY411S	CE, CUL, (CCC)	430	PA3021	CE, CUL, EAC	463
OY412S	CE, CUL, (CCC)	430	PA3022	CE, CUL, EAC	463
OY413S	CE, CUL, (CCC)	430	PA3023	CE, CUL, EAC	463
OY421S	CE, CUL, (CCC)	429	PA3024	CE, CUL, EAC	463
OY422S	CE, CUL, (CCC)	429	PA3026	CE, CUL, EAC	463
OY423S	CE, CUL, (CCC)	429	PA3027	CE, CUL, EAC	464
OY431S	CE, CUL, (CCC)	420	PA3028	CE, CUL, EAC	464, 527

Order no.	Approvals	Catalogue page
PA3029	CE, CUL, EAC	464
PA3060	CE, EAC	463
PA3521	CE	464
PA3522	CE, CUL	464
PA3523	CE, CUL	464
PA3524	CE, CUL	464
PA3526	CE	464
PA3528	CE, CUL	464, 527
PA3589	CE, CUL	464, 527
PA9020	CE, CUL, EAC	464
PA9021	CE, EAC	464
PA9022	CE, CUL, EAC	464
PA9023	CE, CUL, EAC	465
PA9024	CE, CUL, EAC	465
PA9026	CE, CUL, EAC	465
PA9027	CE, CUL, EAC	465
PA9028	CE, CUL, EAC	465
PA9029	CE, CUL, EAC	465
PA9060	CE, EAC	464
PF2953	CE, CUL, FDA	470
PF2954	CE, CUL, FDA	470
PF2956	CE, CUL, FDA	470
PF2957	CE, CUL, FDA	470
PG2409	CE, CUL, EAC, TUEV_S	454
PG2450	CE, EAC, TUEV_S	453
PG2451	CE, CUL, EAC, TUEV_S	453
PG2452	CE, CUL, EAC, TUEV_S	454
PG2453	CE, CUL, EAC, TUEV_S	454
PG2454	CE, CRN, CUL, EAC, TUEV_S	454
PG2455	CE, CUL, EAC, TUEV_S	454
PG2456	CE, CUL, EAC, TUEV_S	454
PG2457	CE, CUL, EAC, TUEV_S	454
PG2458	CE, CUL, EAC, TUEV_S	454
PG2489	CE, CUL, EAC, TUEV_S	454
PG2789	CE, EAC, EC19352004, EHEDG, FDA, TUEV_S	469, 528
PG2793	CE, EAC, EC19352004, EHEDG, FDA, TUEV_S	469
PG2794	CE, EAC, EC19352004, EHEDG, FDA, TUEV_S	469
PG2795	CE, EAC, EC19352004, EHEDG, FDA, TUEV_S	469
PG2796	CE, EAC, EC19352004, EHEDG, FDA, TUEV_S	469, 528
PG2797	CE, EAC, EC19352004, EHEDG, FDA, TUEV_S	469, 528
PG2798	CE, EAC, EC19352004, EHEDG, FDA, TUEV_S	469, 528
PG2799	CE, EAC, EC19352004, EHEDG, FDA, TUEV_S	469, 528
PG2889	CE, EAC, EC19352004, EHEDG, FDA, TUEV_S	470, 529
PG2893	CE, EAC, EC19352004, EHEDG, FDA, TUEV_S	470
PG2894	CE, EAC, EC19352004, EHEDG, FDA, TUEV_S	470
PG2895	CE, EAC, EC19352004, EHEDG, FDA, TUEV_S	470
PG2896	CE, EAC, EC19352004, EHEDG, FDA, TUEV_S	470, 529
PG2897	CE, EAC, EC19352004, EHEDG, FDA, TUEV_S	470, 529
PG2898	CE, EAC, EC19352004, EHEDG, FDA, TUEV_S	470, 529
PG2899	CE, EAC, EC19352004, EHEDG, FDA, TUEV_S	470, 529

Order no.	Approvals	Catalogue page
PI003A	CE, EC19352004, FDA	467
PI008A	CE, EC19352004, FDA	467
PI009A	CE, EC19352004, FDA	467
PI2203	CE, CUL, EAC, EC19352004, EHEDG, FDA	468
PI2204	CE, CUL, EAC, EC19352004, EHEDG, FDA	468
PI2205	CE, CUL, EAC, EC19352004, EHEDG, FDA	468
PI2206	CE, CUL, EAC, EC19352004, EHEDG, FDA	468, 528
PI2207	CE, CUL, EAC, EC19352004, EHEDG, FDA	468, 528
PI2209	CE, CUL, EAC, EC19352004, EHEDG, FDA	468, 528
PI2303	CE, CUL, EAC, EC19352004, EHEDG, FDA	469
PI2304	CE, CUL, EAC, EC19352004, EHEDG, FDA	469
PI2305	CE, CUL, EAC, EC19352004, EHEDG, FDA	469
PI2306	CE, CUL, EAC, EC19352004, EHEDG, FDA	469
PI2307	CE, CUL, EAC, EC19352004, EHEDG, FDA	469
PI2309	CE, CUL, EAC, EC19352004, EHEDG, FDA	469
PI2789	CE, CUL, EAC, EC19352004, EHEDG, FDA	467, 527
PI2793	CE, CUL, EAC, EC19352004, EHEDG, FDA	467
PI2794	CE, CUL, EAC, EC19352004, EHEDG, FDA	467
PI2795	CE, CUL, EAC, EC19352004, EHEDG, FDA	467
PI2796	CE, CUL, EAC, EC19352004, EHEDG, FDA	467, 528
PI2797	CE, CUL, EAC, EC19352004, EHEDG, FDA	467, 527
PI2798	CE, CUL, EAC, EC19352004, EHEDG, FDA	467, 527
PI2799	CE, CUL, EAC, EC19352004, EHEDG, FDA	467, 527
PI2889	ACS, CE, CUL, EAC, EC19352004, EHEDG, FDA	468, 528
PI2893	ACS, CE, CUL, EAC, EC19352004, EHEDG, FDA	467
PI2894	ACS, CE, CUL, EAC, EC19352004, EHEDG, FDA	468
PI2895	ACS, CE, CUL, EAC, EC19352004, EHEDG, FDA	468
PI2896	ACS, CE, CUL, EAC, EC19352004, EHEDG, FDA	468, 528
PI2897	ACS, CE, CUL, EAC, EC19352004, EHEDG, FDA	468, 528
PI2898	ACS, CE, CUL, EAC, EC19352004, EHEDG, FDA	468, 528
PI2899	ACS, CE, CUL, EAC, EC19352004, EHEDG, FDA	468, 528
PK5520	CE, CUL	455
PK5521	CE, CUL	455
PK5522	CE, CUL	455
PK5523	CE, CUL	455
PK5524	CE, CUL	455
PK6520	CE, CUL	455
PK6521	CE, CUL	455
PK6522	CE, CUL	455
PK6523	CE, CUL	455
PK6524	CE, CUL, CRN	455
PK7520	CE, CUL	455
PK7521	CE, CUL	456
PK7522	CE, CUL	456
PK7523	CE, CUL	456
PK7524	CE, CUL	456
PN2070	CE, CUL, EAC	450
PN2071	CE, CUL, EAC	450
PN2092	CE, CUL	450
PN2093	CE, CUL, EAC	450

Standards and approvals / list of articles

Order no.	Approvals	Catalogue page	Order no.	Approvals	Catalogue page
PN2094	CE, CUL, EAC	450	PN7594	CE, CUL, EAC	453
PN2096	CE, CUL, EAC	450	PN7596	CE, CUL, EAC	453
PN2097	CE, CUL, EAC	450	PN7597	CE, CUL, EAC	453
PN2098	CE, CUL, EAC	450	PN7599	CE, CUL, EAC	453
PN2099	CE, CUL, EAC	450	PN7809	CE, CUL, EAC	457
PN2160	CE, CUL, EAC	450	PN7834	CE, CUL, EAC	457
PN2169	CE, CUL, EAC	450	PP0520	CE	456
PN2560	CE, CUL, EAC	450	PP0521	CE	456
PN2569	CE, CUL, EAC	451	PP0522	CE, CUL	456
PN2570	CE, CUL, EAC	450	PP0523	CE, CUL	457
PN2571	CE, CUL, EAC	450	PP0524	CE, CUL	457
PN2592	CE, CUL, EAC	450	PP2001	CE, CUL, EAC	473
PN2593	CE, CUL, EAC	450	PP7550	CE	456
PN2594	CE, CUL, EAC	451	PP7551	CE	456
PN2596	CE, CUL, EAC	451	PP7552	CE, CUL	456
PN2597	CE, CUL, EAC	451	PP7553	CE, CUL	456
PN2598	CE, CUL, EAC	451	PP7554	CE, CUL	456
PN2599	CE, CUL, EAC	451	PP7556	CE, CUL	456
PN3070	CE, CUL, EAC	451	PQ0809	CE, CUL, EAC	457
PN3071	CE, CUL, EAC	451	PQ0834	CE, CUL, EAC	457
PN3092	CE, CUL, EAC	451	PQ3809	CE, CUL	457
PN3093	CE, CUL, EAC	451	PQ3834	CE, CUL	457
PN3094	CE, CUL, EAC	451	PQ7809	CE, CUL	457
PN3096	CE, CUL, EAC	451	PQ7834	CE, CUL	457
PN3097	CE, CUL, EAC	451	PS307A	CE, GL, IEC	466, 527
PN3129	CE, CUL, EAC	451	PS308A	CE, GL, IEC	466, 527
PN3160	CE, CUL, EAC	451	PS317A	CE, GL, IEC	466, 527
PN3529	CE, CUL, EAC	452	PS3208	CE	465, 526
PN3560	CE, CUL, EAC	451	PS3407	CE	465, 526
PN3570	CE, CUL, EAC	452	PS3417	CE	465, 526
PN3571	CE, CUL, EAC	452	PS3427		465, 526
PN3592	CE, CUL, EAC	452	PS3607		465, 526
PN3593	CE, CUL, EAC	452	PS3617		466, 526
PN3594	CE, CUL, EAC	452	PS4208	CE	466, 526
PN3596	CE, CUL, EAC	452	PS4407	CE	466, 526
PN3597	CE, CUL, EAC	452	PS4408	CE	466
PN7070	CE, CUL, EAC	452	PS4417	CE	466, 526
PN7071	CE, CUL, EAC	452	PS4506	CE	466
PN7092	CE, CUL, EAC	452	PS4607	CE	466
PN7093	CE, CUL, EAC	452	PS7570	CE, EAC	465
PN7094	CE, CUL, EAC	452	PT0504	CE	458
PN7096	CE, CUL, EAC	453	PT0505	CE	458
PN7097	CE, CUL, EAC	453	PT0507	CE	458
PN7099	CE, CUL, EAC	453	PT0517	CE	458
PN7160	CE, CUL, EAC	452	PT5400	CE, CUL, DNV_GL	458
PN7560	CE, CUL, EAC	453	PT5401	CE, CUL, DNV_GL	458
PN7570	CE, CUL, EAC	453	PT5402	CE, CUL, DNV_GL	458
PN7571	CE, CUL, EAC	453	PT5403	CE, CUL, DNV_GL	458
PN7592	CE, CUL, EAC	453	PT5404	CE, CUL, DNV_GL	459
PN7593	CE, CUL, EAC	453	PT5412	CE, CUL, DNV_GL	458

Order no.	Approvals	Catalogue page
PT5414	CE, CUL, DNV_GL	459
PT5415	CE, CUL, DNV_GL	459
PT5423	CE, CUL, DNV_GL	458
PT5443	CE, CUL, DNV_GL	458
PT5460	CE, CUL, DNV_GL	458
PT5494	CE, CUL, DNV_GL	459
PT5500	CE, EAC	462, 741
PT5501	CE, EAC	462, 741
PT5502	CE, EAC	462, 742
PT5503	CE, EAC	462, 742
PT5504	CE, EAC	462, 742
PT5560	CE, EAC	462, 741
PT5600	CE, EAC	740
PT5601	CE, EAC	740
PT5602	CE, EAC	740
PT5603	CE, EAC	740
PT5604	CE, EAC	740
PT5660	CE, EAC	740
PT5700	CE, EAC	463, 740
PT5701	CE, EAC	463, 740
PT5702	CE, EAC	463, 740
PT5703	CE, EAC	463, 741
PT5704	CE, EAC	463, 741
PT5760	CE, EAC	463, 741
PT9550	CE, CUL	460, 742
PT9551	CE, CUL	460, 742
PT9552	CE, CUL	460, 742
PT9553	CE, CUL	460, 742
PT9554	CE, CUL	460, 742
PU5400	CE, CUL	459
PU5401	CE, CUL	459
PU5402	CE, CUL	459
PU5403	CE, CUL	459
PU5404	CE, CUL	459
PU5412	CE, CUL	459
PU5414	CE, CUL	459
PU5415	CE, CUL	459
PU5423	CE, CUL	459
PU5443	CE, CUL	459
PU5460	CE, CUL	459
PU5600	CE, EAC	461, 739
PU5601	CE, EAC	461, 739
PU5602	CE, EAC	462, 739
PU5603	CE, EAC	462, 739
PU5604	CE, EAC	462, 739
PU5660	CE, EAC	461, 739
PU5700	CE, EAC	460, 740
PU5701	CE, EAC	460, 740
PU5702	CE, EAC	460, 740
PU5703	CE, EAC	460, 740

Order no.	Approvals	Catalogue page
PU5704	CE, EAC	460, 740
PU5760	CE, EAC	460, 740
PU8500	CE, EAC	461
PU8501	CE, EAC	461
PU8502	CE, EAC	461
PU8503	CE	461
PU8504	CE	461
PU8523	CE, EAC	461
PU8560	CE, EAC	461
PU8700	CE	460, 741
PU8701	CE	460, 741
PU8702	CE	460, 741
PU8703	CE	461, 741
PU8704	CE	461, 741
PU8712	CE	461, 741
PU8743	CE	461, 741
PU8760	CE	461, 741
PV7000	CE	454
PV7001	CE	454
PV7002	CE	454
PV7003	CE	454
PV7004	CE	455
PV7023	CE	454
QA0011		171, 255
QA0012		171, 255
RA3100	CE	346
RA3101	CE	346
RA3102	CE	346
RA3500	CE	347
RA3501	CE	347
RB3100	CE	346
RB3500	CE	346
RM3006	CE, PI	349
RM3007	CE, PI	349
RM3008	CE, PI	349
RM3010	CE, Profinet	349
RM3011	CE	349
RM7011	CE	350
RM7012	CE	350
RM8001	CE	348
RM8002	CE	348
RM8003	CE	348
RM8004	CE, CUL	348
RM9000	CE, CUL, E1R, (CCC)	734
RM9001	CE, CUL, E1R, (CCC)	734
RM9010	CE	350
RN3001	CE, PI	348
RN7011	CE	349
RN7012	CE	349
RO3100	CE	347

**Standards and approvals /
list of articles**

Order no.	Approvals	Catalogue page	Order no.	Approvals	Catalogue page
RO3101	CE	347	SBY332	CE, CUL, EAC	495
RO3102	CE	347	SBY333	CE, CUL, EAC	495
RO3103	CE	347	SBY334	CE, CUL, EAC	495
RO3104	CE	347	SBY346	CE, CUL, EAC	495
RO3500	CE	347	SBY357	CE, CUL, EAC	495
RO3501	CE	347	SBY433	CE, CUL, EAC	496
ROP520	CE	347	SBY434	CE, CUL, EAC	496
ROP521	CE	348	SBY446	CE, CUL, EAC	496
ROP522	CE	348	SBY457	CE, CUL, EAC	496
ROP523	CE	348	SD0523	CE, CRN, CUL, EAC	500
ROP524	CE	348	SD2000	CE, CUL, EAC	500
RU3100	CE	346	SD5000	CE, CUL, EAC	499
RU3500	CE	346	SD5100	CE, CUL	500
RUP500	CE	347	SD6000	CE, CRN, CUL, EAC	499
RV3100	CE	346	SD6050	CE, CUL, EAC	499
RV3500	CE	346	SD6100	CE, CUL, EAC	500
RVP510	CE	347	SD8000	CE, CUL, EAC	500
SA2000	CE, CUL	491	SD9000	CE, CUL, EAC	500
SA2004	CE, CUL	491	SF111A	CE, IEC	498
SA4100	ACS, CE, CUL, KTW, Reg31	491	SF120A	CE, IEC	498
SA4104	ACS, CE, CUL, KTW, Reg31	492	SF121A	CE, IEC	498
SA4300	ACS, CE, CUL, KTW, Reg31	491	SF211A	CE, IEC	498
SA4304	ACS, CE, CUL, KTW, Reg31	492	SF220A	CE, IEC	498
SA5000	CE, CUL	491	SF221A	CE, IEC	498
SA5004	CE, CUL	491	SF2405	CUL	497
SA5040	ACS, CE, CUL, KTW, Reg31	491	SF2410	CUL	497
SBG232	CE, CRN, CUL, EAC	494	SF311A	CE, IEC	498
SBG233	CE, CRN, CUL, EAC	494	SF320A	CE, IEC	498
SBG234	CE, CRN, CUL, EAC	494	SF321A	CE, IEC	498
SBG246	CE, CRN, CUL, EAC	494	SF323A	CE, IEC	498
SBG257	CE, CRN, CUL, EAC	495	SF3405		497
SBG332	CE, CUL, EAC	495	SF3410		497
SBG333	CE, CUL, EAC	495	SF5200	CUL, EAC	496
SBG334	CE, CUL, EAC	495	SF5201	CUL	496
SBG346	CE, CUL, EAC	495	SF5300	CUL, EAC	497
SBG357	CE, CUL, EAC	495	SF5350	CUL	496
SBT633	CE, EAC	496	SF5700	CUL	497
SBT634	CE, EAC	496	SF5800	CUL	497
SBU323	CE, CUL, EAC	493	SF6200	CUL, Reg31	496
SBU324	CE, CUL, EAC	493	SF6201	CUL, Reg31	496
SBU623	CE, CUL, EAC	494	SF620A	CE, IEC	498
SBU624	CE, CUL, EAC	494	SI0521	CE, EAC, GL	493
SBU625	CE, CUL, EAC	494	SI0553	CE, EAC	492
SBY232	CE, CRN, CUL, EAC	494	SI5000	CE, CUL, EAC	490
SBY233	CE, CRN, CUL, EAC	494	SI5002	CE, CUL, EAC	490
SBY234	CE, CRN, CUL, EAC	494	SI5004	CE, CRN, CUL, EAC	491
SBY246	CE, CRN, CUL, EAC	494	SI5006	CE, CRN, CUL, EAC	491
SBY257	CE, CRN, CUL, EAC	494	SI5007	CE, CUL, EAC	492
SBY321	CE, CUL, EAC	495	SI500A	CE	493
SBY323	CE, CUL, EAC	495	SI5010	CE, CRN, CUL, EAC	491

Order no.	Approvals	Catalogue page
SI5100	CE, EAC	492
SI6600	CE, CRN, CUL, EAC, EC19352004, EHEDG, FDA	493
SI6700	CE, CUL, EAC, EC19352004, EHEDG, FDA	493
SI6800	CE, CRN, CUL, EAC, EC19352004, EHEDG, FDA	493
SL0101	CE, EAC	499
SL0201	CE	499
SL5101	CE, EAC	499
SM0510	CE, CUL, EAC	489
SM2000	CE, CUL, EAC	489
SM2004	CE, CUL, EAC	489
SM2100	ACS, CE, CUL, EAC	489
SM6000	CE, CUL, EAC	488
SM6004	CE, CUL, EAC	489
SM6050	CE, CUL, EAC	490
SM6100	ACS, CE, CUL, EAC, Reg31	489
SM7000	CE, CUL, EAC	488
SM7004	CE, CUL, EAC	489
SM7050	CE, CUL	490
SM7100	ACS, CE, CUL, Reg31	489
SM8000	CE, CUL, EAC	488
SM8004	CE, CUL, EAC	489
SM8050	CE, CUL	490
SM8100	ACS, CE, CUL, Reg31	490
SM9000	CE, CUL, EAC	489
SM9004	CE, CUL	489
SM9100	ACS, CE, CUL, EAC, Reg31	490
SN0150	CE, CUL	582
SN0151	CE, CUL, EAC	582
SN2301	CE, IEC	582
SN2302	CE, IEC	582
SP321A	CE, IEC	499
SR0150	CE, CUL	582
SR0153	CE, CUL	582
SR2301	CE, IEC	583
SR307A	CE, IEC	583
SR5900	CE, CUL	582
SR5906	CE, CUL	582
SU7000	CE, CUL	500
SU7200	CE, CUL	500
SU8000	CE, CUL	501
SU8200	CE, CUL	500
SU9000	CE, CUL	501
SU9004	CE, CUL	501
SV3050	CE	487
SV3150	CE	487
SV4050	CE	488
SV4150	CE	488
SV4200	CE, CUL	487
SV4204	CE, CUL	487
SV4500	CE, CUL	487

Order no.	Approvals	Catalogue page
SV4504	CE, CUL	487
SV5050	CE	488
SV5150	CE	488
SV5200	CE, CUL	487
SV5204	CE, CUL	487
SV5500	CE, CUL	487
SV5504	CE, CUL	487
SV6050	CE	488
SV6150	CE	488
SV7050	CE	488
SV7150	CE	488
SV7200	CE, CUL	487
SV7204	CE, CUL	487
SV7500	CE, CUL	487
SV7504	CE, CUL	487
SV8050	CE	488
SV8150	CE	488
TA2002	CE, CUL, EC19352004, FDA	556
TA2012	CE, CUL, EC19352004, FDA	556
TA2105	CE, CUL, DNV_GL	553
TA2115	CE, CUL, DNV_GL	553
TA2135	CE, CUL, DNV_GL	553
TA2145	CE, CUL, DNV_GL	553
TA2212	CE, CUL, EC19352004, FDA	557
TA2232	CE, CUL, EC19352004, FDA	557
TA2242	CE, CUL, EC19352004, FDA	557
TA2405	CE, CUL, DNV_GL	552
TA2415	CE, CUL, DNV_GL	552
TA2417	CE, CUL, DNV_GL	552
TA2435	CE, CUL, DNV_GL	553
TA2437	CE, CUL, DNV_GL	553
TA2445	CE, CUL, DNV_GL	553
TA2447	CE, CUL, DNV_GL	553
TA2502	CE, CUL, EC19352004, EHEDG, FDA	556
TA2512	CE, CUL, EC19352004, EHEDG, FDA	556
TA2532	CE, CUL, EC19352004, EHEDG, FDA	556
TA2542	CE, CUL, EC19352004, EHEDG, FDA	556
TA2802	CE, CUL, EC19352004, EHEDG, FDA	556
TA2812	CE, CUL, EC19352004, EHEDG, FDA	556
TA2832	CE, CUL, EC19352004, EHEDG, FDA	556
TA2842	CE, CUL, EC19352004, EHEDG, FDA	556
TA3105	CE, CUL	553, 742
TA3115	CE, CUL	553, 742
TA3155	CE, CUL	553, 742
TA3597	CE, EC19352004, FDA	557
TA4105	CE, CUL	553, 742
TA4115	CE, CUL	554, 743
TA5105	CE, CUL	554, 743
TA5115	CE, CUL	554, 743
TAD081	CE, CUL, EC19352004, EHEDG, FDA	557

**Standards and approvals /
list of articles**

Order no.	Approvals	Catalogue page	Order no.	Approvals	Catalogue page
TAD091	CE, CUL, EC19352004, EHEDG, FDA	557	TM4441	CUL	549
TAD181	CE, CUL, EC19352004, EHEDG, FDA	557	TM4461	CUL	549
TAD191	CE, CUL, EC19352004, EHEDG, FDA	557	TM4501	CUL, EC19352004, EHEDG, FDA	555
TAD981	CE, CUL, EC19352004, EHEDG, FDA	557	TM4511	CUL, EC19352004, EHEDG, FDA	555
TAD991	CE, CUL, EC19352004, EHEDG, FDA	557	TM4531	CUL, EC19352004, EHEDG, FDA	556
TD2211	CE, CUL, EC19352004, FDA	559	TM4541	CUL, EC19352004, EHEDG, FDA	556
TD2217	CE, CUL, EC19352004, FDA	559	TM4591	CUL, EC19352004, EHEDG, FDA	555
TD2231	CE, CUL, EC19352004, FDA	559	TM4599	EC19352004, FDA	556
TD2237	CE, CUL, EC19352004, FDA	559	TM4801	CUL, EC19352004, EHEDG, FDA	555
TD2241	CE, CUL, EC19352004, FDA	559	TM4811	CUL, EC19352004, EHEDG, FDA	555
TD2247	CE, CUL, EC19352004, FDA	559	TM4831	CUL, EC19352004, EHEDG, FDA	555
TD2251	CE, CUL, EC19352004, FDA	559	TM4841	CUL, EC19352004, EHEDG, FDA	555
TD2257	CE, CUL, EC19352004, FDA	560	TM4901	CUL, EC19352004, EHEDG, FDA	555
TD2261	CE, CUL, EC19352004, FDA	559	TM4911	CUL, EC19352004, EHEDG, FDA	555
TD2267	CE, CUL, EC19352004, FDA	559	TM4931	CUL, EC19352004, EHEDG, FDA	555
TD2271	CE, CUL, EC19352004, FDA	560	TM4941	CUL, EC19352004, EHEDG, FDA	555
TD2277	CE, CUL, EC19352004, FDA	560	TM5101	CUL	549, 554
TD2291	CE, CUL, EC19352004, FDA	560	TM5411	CUL	549
TD2297	CE, CUL, EC19352004, FDA	560	TM6101		554, 743
TD2501	CE, CRN, CUL, EC19352004, EHEDG, FDA	558	TM9950	CUL	549
TD2507	CE, CRN, CUL, EC19352004, EHEDG, FDA	558	TN2105	CE, CUL	547
TD2511	CE, CRN, CUL, EC19352004, EHEDG, FDA	558	TN2115	CE, CUL	547
TD2517	CE, CUL, EC19352004, EHEDG, FDA	558	TN2405	CE, CUL	546
TD2531	CE, CRN, CUL, EC19352004, EHEDG, FDA	558	TN2415	CE, CUL	546
TD2537	CE, CRN, CUL, EC19352004, EHEDG, FDA	558	TN2435	CE, CUL	546
TD2541	CE, CRN, CUL, EC19352004, EHEDG, FDA	558	TN2445	CE, CUL	546
TD2547	CE, CRN, CUL, EC19352004, EHEDG, FDA	558	TN2511	CE, CUL	546
TD2801	CE, CUL, EC19352004, EHEDG, FDA	558	TN7511	CE, CUL	546
TD2807	CE, CUL, EC19352004, EHEDG, FDA	558	TP3231	CE, CUL	547
TD2811	CE, CUL, EC19352004, EHEDG, FDA	558	TP3232	CE, CUL	547
TD2817	CE, CUL, EC19352004, EHEDG, FDA	558	TP3237	CE, CUL	547
TD2831	CE, CUL, EC19352004, EHEDG, FDA	558	TP9237	CE, CUL	547
TD2837	CE, CUL, EC19352004, EHEDG, FDA	558	TR2439	CE, CUL	547
TD2841	CE, CUL, EC19352004, EHEDG, FDA	558	TR7439	CE, CUL	547
TD2847	CE, CUL, EC19352004, EHEDG, FDA	558	TS0759		551
TD2901	CE, CUL, EC19352004, EHEDG, FDA	559	TS2056		550
TD2907	CE, CUL, EC19352004, EHEDG, FDA	559	TS2069		550
TD2911	CE, CUL, EC19352004, EHEDG, FDA	559	TS2089		550
TD2917	CE, CUL, EC19352004, EHEDG, FDA	559	TS2229		551
TD2931	CE, CUL, EC19352004, EHEDG, FDA	559	TS2239		551
TD2937	CE, CUL, EC19352004, EHEDG, FDA	559	TS2256		550
TD2941	CE, CUL, EC19352004, EHEDG, FDA	559	TS2269		550
TD2947	CE, CUL, EC19352004, EHEDG, FDA	559	TS2289		550
TK6110	CE, CUL	546	TS2451		551
TK6310	CE, CUL	546	TS2452		551
TK7110	CE, CUL	546	TS2453		551
TK7460	CE, CUL	546	TS2454		551
TM4101	CUL	549	TS2659		550
TM4411	CUL	549	TS2689	CE	550
TM4431	CUL	549	TS2759		550

Order no.	Approvals	Catalogue page
TS2789		550
TS285A	CE	552
TS325A	CE	552
TS4759		550
TS502A	CE	552
TS5089		551
TS522A	CE	552
TS5289		551
TS9256		550
TS9289		551
TS9789		550
TT0281	CUL	548
TT0291	CUL, EC19352004, FDA	554
TT1050	CUL	548
TT1081	CUL	549
TT1250	CUL	548
TT1281	CUL	548
TT1291	CUL, EC19352004, FDA	555
TT2050	CUL	548
TT2081	CUL	549
TT2250	CUL	548
TT2281	CUL	548
TT2291	CUL, EC19352004, FDA	555
TT3050	CUL	548
TT3081	CUL	549
TT3250	CUL	548
TT3281	CUL	549
TT3291	CUL, EC19352004, FDA	555
TT4281	CUL	548
TT5050	CUL	548
TT5081	CUL	549
TT6281	CUL	548
TT7281	CUL	548
TT9281	CUL	549
TT9291	CUL, FDA	554
TU3105	CE, CUL	554, 743
TU4105	CE, CUL	554, 743
TU5105	CE, CUL	554, 743
TV7105	CE, CUL	560
TV7405	CE, CUL	560
TW2000	CE	560
TW2001	CE	560
TW2002	CE	560
TW2011	CE	560
TW7000	CE	561
TW7001	CE	561
TW7011	CE	561
UGR500	CE, CUL	216
UGR501	CE, CUL	216
UGR502	CE, CUL	216

Order no.	Approvals	Catalogue page
UGR503	CE, CUL	216
UGT200	CE, CUL	212
UGT201	CE, CUL	212
UGT202	CE, CUL	212
UGT203	CE, CUL	212
UGT204	CE, CUL	212
UGT205	CE, CUL	213
UGT206	CE, CUL	212
UGT207	CE, CUL	212
UGT208	CE, CUL	213
UGT209	CE, CUL	212
UGT210	CE, CUL	212
UGT211	CE, CUL	212
UGT212	CE, CUL	212
UGT213	CE, CUL	212
UGT214	CE, CUL	212
UGT500	CE, CUL	213
UGT501	CE, CUL	213
UGT502	CE, CUL	214
UGT503	CE, CUL	213
UGT504	CE, CUL	213
UGT505	CE, CUL	214
UGT506	CE, CUL	213
UGT507	CE, CUL	213
UGT508	CE, CUL	214
UGT509	CE, CUL	215
UGT510	CE, CUL	215
UGT511	CE, CUL	215
UGT512	CE, CUL	215
UGT513	CE, CUL	215
UGT514	CE, CUL	216
UGT515	CE, CUL	216
UGT516	CE, CUL	216
UGT517	CE, CUL	216
UGT518	CE, CUL	216
UGT519	CE, CUL	216
UGT520	CE, CUL	216
UGT521	CE, CUL	213
UGT522	CE, CUL	213
UGT523	CE, CUL	213
UGT524	CE, CUL	214
UGT525	CE, CUL	214
UGT526	CE, CUL	214
UGT580	CE, CUL	214
UGT581	CE, CUL	214
UGT582	CE, CUL	214
UGT583	CE, CUL	214
UGT584	CE, CUL	214
UGT585	CE, CUL	214
UGT586	CE, CUL	214

Standards and approvals / list of articles

Order no.	Approvals	Catalogue page
UGT587	CE, CUL	215
UGT588	CE, CUL	215
UGT589	CE, CUL	215
UGT590	CE, CUL	215
UGT591	CE, CUL	215
UGT592	CE	215
UGT593	CE	215
UGT594	CE	215
VES004		688
VKV021	CE, CUL	686
VKV022	CE, CUL	686
VNA001	CE, CUL, EAC	689
VNB001	CE, CUL, EAC	687
VNB211	CE, CUL, EAC	687
VOS001		688
VOS002		688
VOS003		688
VOS004		688
VOS005		688
VSA001	CE, CUL	689
VSA002	CE, CUL, EAC	689
VSA004	CE, CUL, EAC	689
VSA005	CE, CUL	689
VSA006	CE, CUL, EAC	689
VSA101	CE, CUL, EAC	689
VSA201	CE, CUL, EAC	689
VSE002	CE, CUL	688
VSE100	CE, CUL	688
VSE150	CE, Profinet	688
VSP001	CE	689
VSP003	CE	689
VSP01A	CE, IEC	689
VSP02A	CE, IEC	689
VTV121	CE, CUL	687
VTV122	CE, CUL	687
VTV12A	CE	687
ZC0004		471, 531
ZC0005		471, 531
ZC0013		562
ZC0014		562
ZC0015		563
ZC0016		563
ZC0017		563
ZC0018		563
ZC0061		563
ZC0062		563
ZC0063		563
ZC0069		531
ZZ0214	CE, (CCC)	329, 591



AS-Interface

AS-Interface (actuator sensor interface) is a worldwide manufacturer-independent standard for the connection of actuators and sensors of the first field level. Data and power supply are jointly transmitted via a two-wire cable. Wiring complexity, documentation and set-up times are reduced.

ATEX

ATEX (Atmosphère explosible) is a brief description of the uniform EU directives 94/9/EC (for manufactures of units for hazardous areas) and 1999/92/EC (for operators of plants for hazardous areas) governing the safety requirements for explosion-hazardous areas. Since 30 June 2003, units for hazardous areas have to be approved to 94/9/EU regulations. For further information about international directives see the "Approvals" chapter.

e1 type approval









The e1 type approval by the German Federal Motor Transport Authority certifies that the units comply with the automotive standards.







IO-Link

IO-Link is a field-bus independent and open point-to-point communication interface. It is a low-cost possibility to transmit parameter, diagnosis and process data from a sensor or an actuator via an I/O module.

Safety

The EC Machinery Directive stipulates machinery should not present a risk. If safety is dependent on control systems, these must be designed so as to minimise malfunction. The IEC 62061 und ISO 13849-1 standards apply. Classification is made either in the Safety Integrity Level (SIL 1-3 in IEC 62061) or in the Performance Level (PL a-e in ISO 13849-1).

<i>AS-i sensors</i>		<i>Page</i>
	AS-i sensors	634 - 635
	Valve sensors	327 - 327 329 - 329 589 - 589 591 - 591 638 - 639
<i>Sensors for hazardous areas (ATEX)</i>		<i>Page</i>
	Inductive sensors	123 - 128
	Capacitive sensors	167 - 168
	Cylinder sensor	197 - 197
	Valve sensors	328 - 329 590 - 590 638 - 638
	Photoelectric sensors	250 - 251 289 - 290
	Flow sensors	493 - 493 498 - 499

Sensors for hazardous areas (ATEX)		Page
	Pressure sensors	466 - 467 527 - 527
	Temperature sensors	552 - 552
	Diagnostic systems	687
Sensors with e1 approval		Page
	Inductive sensors	736 - 738
	Pressure sensors	739 - 742
Sensors with IO-Link		Page
	Capacitive sensors	164 - 167
	Pressure sensors	456 - 457

<i>Sensors with IO-Link</i>		<i>Page</i>
-----------------------------	--	-------------

	Temperature sensors	546 - 547 558 - 557 560 - 560
---	---------------------	-------------------------------------

<i>Sensors for safety technology</i>		<i>Page</i>
--------------------------------------	--	-------------

	Inductive sensors	404 - 405
---	-------------------	-----------

	Safety light curtains	409 - 410 412 - 419 421 - 422
---	-----------------------	-------------------------------------

	Safety light grid	428 - 430
---	-------------------	-----------



Short-range and long-range object detection



Different measurement techniques

ifm offers a wide range of position sensors. Inductive, capacitive and magnetic sensors detect targets or objects in the range of a few millimetres up to several centimetres. For greater distances there are photoelectric sensors with ranges up to tens of metres.

Moreover, special types such as optical fork and angle sensors, fibre optics, colour and contrast sensors or cylinder sensors are used for position detection in special applications. ifm also offers suitable solutions for the detection of valve positions.

All sensors are fully electronic, i.e. they work without mechanical components. Advantage: they are wear-free and provide high switching frequencies.

Microprocessor technology makes it possible

The applied microprocessor technology allows fast and easy switch point setting via pushbuttons and potentiometer. Clearly visible LEDs indicate the switching status. In addition to the 3-wire output stage, many position sensors can also be supplied in a 2-wire version. ifm also offers sensors with a built-in AS-Interface (AS-i).

Special applications

Sensors are used in many different areas. These include machine and plant construction as well as applications in factory automation and process technology. Special solutions are, for example, provided for food applications or mobile machines.

Besides constructional measures such as high-quality housing materials and coatings, the sensors also comply with applicable approvals (e.g. ATEX or e1).

Regular and thorough testing in production to the highest standards combined with equally high standards at the development stage ensure a consistently high quality.

	<i>Inductive sensors</i>	70 - 158
	<i>Capacitive sensors</i>	160 - 178
	<i>Magnetic sensors</i>	180 - 189
	<i>Cylinder sensors</i>	190 - 209
	<i>Ultrasonic sensors</i>	210 - 218
	<i>Photoelectric sensors for general applications</i>	220 - 273
	<i>Photoelectric fork sensors / angle sensors</i>	274 - 279
	<i>Laser sensors / distance measurement sensors</i>	280 - 296
	<i>Fibre optic sensors</i>	298 - 315
	<i>Photoelectric sensors for specific applications</i>	316 - 323
	<i>Feedback systems for valves and valve actuators</i>	324 - 336
	<i>Switching amplifiers</i>	338 - 340



Position sensors

Inductive sensors for all application areas



Inductive sensors



- Sensors for all application areas
- Wide choice of housing types and operating voltages
- High-quality housing materials
- Vast selection of assembly and connection technology

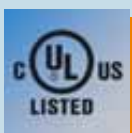
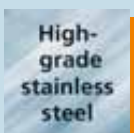
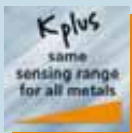

Inductive sensors

Inductive sensors offer ideal characteristics compared to mechanical switches: non-contact operation free from any wear and tear, high switching frequencies and accuracy. In addition, they are insensitive to vibration, dust and moisture. Inductive sensors detect all metals without contact.

Application sensors

Temperature shocks, mechanical influences or aggressive cleaning agents are just a few of the possible environmental influences to which sensors are subjected. ifm therefore offers inductive sensors which have been developed for special applications. The use of selected housing materials such as stainless steel, LCP, PEEK, PBT or Duroplast and an innovative, consistent sealing concept from the sensor to the connector ensure ideal protection against penetrating media.

System overview	Page
Sensors with IO-Link	73
Sensors for industrial applications with increased sensing range	73 - 77
Sensors for industrial applications, threaded housings	77 - 83
Sensors for industrial applications with smooth sleeve	83 - 85
Sensors for industrial applications, rectangular housings	85 - 89
Sensors for industrial applications, AC and AC/DC	90 - 92
Sensors for industrial applications with analogue output 4...20 mA	92 - 93
Sensors for industrial applications with analogue output 0...10 V	93
Sensors for industrial high temperature applications	94
Sensors for industrial applications on pipes and tubes	94 - 95
Tube sensors for industrial applications	95 - 96
Sensors for industrial applications, oils and coolants and mobile applications with increased sensing range	96 - 102
Sensors for oils and coolants with increased sensing range	102 - 105
Sensors for oils and coolants, threaded housings	106
Sensors for oils and coolants, rectangular housings	107
Sensors for oils and coolants with correction factor 1	107 - 108
Sensors for oils and coolants with ceramic sensing face	108
Sensors for oils and coolants, AS-i system	109
Electromagnetic field immune Kplus sensors with correction factor 1	109 - 113
Electromagnetic field immune sensors	113
Full metal sensors for oils and coolants	114 - 115
Full metal sensors for oils and coolants with correction factor 0	115
Full metal sensors with non-stick coating against weld spatter	115 - 117
Full metal sensors for hygienic and wet areas	117 - 118
Sensors for hygienic and wet areas with increased sensing range	119 - 121
Sensors for hygienic and wet areas	121 - 123
Sensors with ATEX approval 1D / 2G	123 - 124
Sensors with ATEX approval 1D / 1G / 2G	124 - 125
Sensors with ATEX approval 3D/3G	125 - 126
Sensors with ATEX approval 3D	126 - 127
Sensors with ATEX approval 2D / 3G	128
Switching amplifiers with ATEX approval	128









Position sensors



System overview	Page
Accessories for sensors with smooth sleeve	129
Accessories for threaded M8 housings	129 - 130
Accessories for threaded M12 housings	130 - 131
Accessories for threaded M18 housings	131 - 132
Accessories for threaded M30 housings	132
Accessories for rectangular housings	132
System components	133 - 134
Wiring diagrams	134 - 136
Scale drawings / drawing no. – CAD download: www.ifm.com	137 - 158



Sensors with IO-Link

Type	Dimensions [mm]	Sensing range [mm]	Material	U _b [V]	Protection	f [Hz]	I _{load} [mA]	Drawing no.	Order no.
------	--------------------	-----------------------	----------	-----------------------	------------	-----------	---------------------------	-------------	-----------

M12 connector · Output function  /  · 3-wire · DC PNP/NPN · Wiring diagram no. 36 · Connector groups 8, 10, 19, 21, 23, 25, 148, 149, 153, 184, 188, 193, 202

	M12 / L = 60	0.375...3.75 f	Brass	10...30	IP 65 / IP 66 / IP 67 / IP 68 / IP 69K	600	100	1	IF6123
	M12 / L = 60	0.7...7 nf	Brass	10...30	IP 65 / IP 66 / IP 67 / IP 68 / IP 69K	600	100	2	IF6124
	M18 / L = 60	0.75...7.5 f	Brass	10...30	IP 65 / IP 66 / IP 67 / IP 68 / IP 69K	300	100	3	IG6615
	M18 / L = 60	1.3...13 nf	Brass	10...30	IP 65 / IP 66 / IP 67 / IP 68 / IP 69K	300	100	4	IG6616
	M30 / L = 65	1.3...13 f	Brass	10...30	IP 65 / IP 66 / IP 67 / IP 68 / IP 69K	100	100	5	II5973
	M30 / L = 65	2.3...23 nf	Brass	10...30	IP 65 / IP 66 / IP 67 / IP 68 / IP 69K	100	100	6	II5974

M12 connector · Output function  /  · 3-wire · DC PNP/NPN · Wiring diagram no. 37 · Connector groups 8, 10, 11, 18, 19, 21, 23, 25, 148, 149, 150, 153, 154, 184, 188, 190, 193, 202, 203, 204



	40 x 40 x 54	2.1...21 f	PA (polyamide)	10...30	IP 67	100	100	7	IM5172
	40 x 40 x 54	2.6...26 nf	PA (polyamide)	10...30	IP 67	100	100	7	IM5173

f = flush / nf = non flush / qf = quasi-flush

Sensors for industrial applications with increased sensing range

Type	Dimensions [mm]	Sensing range [mm]	Material	U _b [V]	Protection	f [Hz]	I _{load} [mA]	Drawing no.	Order no.
------	--------------------	-----------------------	----------	-----------------------	------------	-----------	---------------------------	-------------	-----------

M12 connector · Output function  · 2-wire · DC PNP/NPN · Wiring diagram no. 1 · Connector groups 8, 10, 19, 21, 23

	M12 / L = 45	4 f	Brass	10...30	IP 67	700	100	8	IFS200
	M12 / L = 50	7 nf	Brass	10...30	IP 67	700	100	9	IFS201















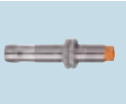

M12 connector · Output function  · 2-wire · DC PNP/NPN · Wiring diagram no. 38 · Connector groups 8, 10, 19, 21, 23

	M18 / L = 46	8 f	Brass	10...30	IP 67	300	100	10	IGS200
---	--------------	-----	-------	---------	-------	-----	-----	----	--------

You can find wiring diagrams and scale drawings from page 134













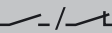

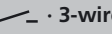

Position sensors

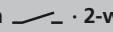
Type	Dimensions [mm]	Sensing range [mm]	Material	U _b [V]	Protection	f [Hz]	I _{load} [mA]	Draw- ing no.	Order no.
M12 connector · Output function  · 2-wire · DC PNP/NPN · Wiring diagram no. 38 · Connector groups 8, 10, 19, 21, 23									
	M18 / L = 51	12 nf	Brass	10...30	IP 67	250	100	11	IGS201
M12 connector · Output function  · 3-wire DC PNP · 2-wire DC PNP/NPN · Wiring diagram no. 39 · Connector groups 8, 10, 11, 18, 19, 21, 23									
	M12 / L = 70	4 f	Brass	10...30	IP 67	500	100	12	IFS208
	M12 / L = 70	7 nf	Brass	10...30	IP 67	500	100	13	IFS209
	M18 / L = 70	8 f	Brass	10...30	IP 67	400	100	14	IGS208
	M18 / L = 70	12 nf	Brass	10...30	IP 67	300	100	15	IGS209
	M30 / L = 70	15 f	Brass	10...36	IP 67	100	100	16	IIS206
	M30 / L = 70	22 nf	Brass	10...36	IP 67	100	100	17	IIS207
M12 connector · Output function  · 3-wire · DC PNP · Wiring diagram no. 2 · Connector groups 8, 10, 19, 21, 23									
	M12 / L = 45	4 f	Brass	10...30	IP 67	700	100	18	IFS204
	M12 / L = 50	7 nf	Brass	10...30	IP 67	700	100	19	IFS205
M12 connector · Output function  · 3-wire · DC PNP · Wiring diagram no. 2 · Connector groups 8, 10, 19, 21, 23, 25, 148, 149, 153, 184, 188, 193, 202									
	M12 / L = 70	4 f	Brass	10...30	IP 67	700	100	20	IFS212
	M12 / L = 70	7 nf	Brass	10...30	IP 67	700	100	21	IFS213
	M18 / L = 45	8 f	Brass	10...30	IP 67	400	100	22	IGS204
	M18 / L = 50	12 nf	Brass	10...30	IP 67	300	100	23	IGS205

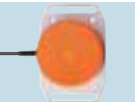
Type	Dimensions [mm]	Sensing range [mm]	Material	U _b [V]	Protection	f [Hz]	I _{load} [mA]	Drawing no.	Order no.
M12 connector · Output function  · 3-wire · DC PNP · Wiring diagram no. 2 · Connector groups 8, 10, 11, 18, 19, 21, 23									
	M18 / L = 70	8 f	Brass	10...36	IP 67	400	100	14	IGS212
	M18 / L = 70	12 nf	Brass	10...36	IP 67	300	100	15	IGS213
M12 connector · Output function  · 3-wire · DC PNP · Wiring diagram no. 2 · Connector groups 8, 10, 19, 21, 23, 202									
	M30 / L = 50	15 f	Brass	10...30	IP 67	100	100	24	IIS204
	M30 / L = 50	22 nf	Brass	10...30	IP 67	100	100	25	IIS205
M12 connector · Output function  · 3-wire · DC PNP · Wiring diagram no. 2 · Connector groups 8, 10, 11, 18, 19, 21, 23									
	M30 / L = 70	15 f	High-grade st. steel	10...36	IP 67	100	100	16	IIS210
	M30 / L = 70	22 nf	High-grade st. steel	10...36	IP 67	100	100	17	IIS211
M12 connector · Output function  · 3-wire · DC PNP · Wiring diagram no. 3 · Connector groups 8, 10, 19, 21, 23									
	M12 / L = 45	4 f	Brass	10...30	IP 67	700	100	18	IFS206
	M12 / L = 50	7 nf	Brass	10...30	IP 67	700	100	19	IFS207
M12 connector · Output function  · 3-wire · DC PNP · Wiring diagram no. 3									
	M18 / L = 45	8 f	Brass	10...30	IP 67	400	100	22	IGS206
M12 connector · Output function  · 3-wire · DC PNP · Wiring diagram no. 3 · Connector groups 8, 10, 19, 21, 23, 25, 148, 149, 153, 184, 188, 193, 202									
	M18 / L = 50	12 nf	Brass	10...30	IP 67	300	100	23	IGS207
M12 connector · Output function  · 3-wire · DC PNP · Wiring diagram no. 3 · Connector groups 8, 10, 19, 21, 23, 202									
	M30 / L = 50	15 f	Brass	10...30	IP 67	100	100	24	IIS208
	M30 / L = 50	22 nf	Brass	10...30	IP 67	100	100	25	IIS209

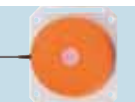

Position sensors

Type	Dimensions [mm]	Sensing range [mm]	Material	U _b [V]	Protection	f [Hz]	I _{load} [mA]	Draw- ing no.	Order no.
M12 connector · Output function  · 2-wire · DC PNP/NPN · Wiring diagram no. 40 · Connector groups 8, 10, 19, 21, 23									
	M18 / L = 70	8 f	Brass	10...36	IP 68	400	100	26	IG5953
	M18 / L = 72	12 nf	Brass	10...36	IP 68	250	100	27	IG5954
M8 connector · Output function  · 3-wire · DC PNP · Wiring diagram no. 2 · Connector groups 1, 2, 3									
	M12 / L = 46	4 f	Brass	10...36	IP 67	700	100	28	IFS210
	M12 / L = 51	7 nf	Brass	10...36	IP 67	700	100	29	IFS211
	M18 / L = 46	8 f	Brass	10...36	IP 67	400	100	30	IG5210
Cable 2 m · Output function  · 2-wire · AC · Wiring diagram no. 4									
	Ø 100	70 nf	PBT	90...250	IP 65	5	200	31	I12001*
	Ø 100	70 nf	PBT	90...250	IP 65	5	200	32	I12003*
	Ø 164	120 nf	PBT	90...250	IP 65	3	200	33	I22001*
	Ø 164	120 nf	PBT	90...250	IP 65	3	200	34	I22003*
Cable 2 m · Output function  · 3-wire · DC PNP · Wiring diagram no. 5									
	Ø 100	70 nf	PBT	10...36	IP 65	5	250	31	I17001
	Ø 100	70 nf	PBT	10...36	IP 65	5	250	32	I17003
	Ø 164	120 nf	PBT	10...36	IP 65	3	250	33	I27001

Type	Dimensions [mm]	Sensing range [mm]	Material	U _b [V]	Protection	f [Hz]	I _{load} [mA]	Drawing no.	Order no.
------	--------------------	-----------------------	----------	-----------------------	------------	-----------	---------------------------	-------------	-----------

7/8" connector · Output function  · 2-wire · AC · Wiring diagram no. 6 · Connector groups 35, 36



Ø 164	120 nf	PBT	90...250	IP 65	3	200	35	IE2006*
-------	--------	-----	----------	-------	---	-----	----	----------------

f = flush / nf = non flush / qf = quasi-flush

*** Note on use of miniature fuses for electrical connection**

Miniature fuse to IEC60127-2 sheet 1, ≤ 2 A (fast acting) Recommendation: check the unit for reliable function after a short circuit.

Sensors for industrial applications, threaded housings

Type	Dimensions [mm]	Sensing range [mm]	Material	U _b [V]	Protection	f [Hz]	I _{load} [mA]	Drawing no.	Order no.
------	--------------------	-----------------------	----------	-----------------------	------------	-----------	---------------------------	-------------	-----------

Cable 0.3 m · with M12 connector · Output function  · 3-wire DC PNP · 2-wire DC PNP/NPN · Wiring diagram no. 39 · Connector groups 8, 10, 11, 18, 19, 21, 23



M8 / L = 37	3 f	Brass	10...30	IP 67	1000	100	36	IE5351
-------------	-----	-------	---------	-------	------	-----	----	---------------

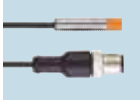

M8 / L = 37	5 nf	Brass	10...30	IP 67	700	100	37	IE5352
-------------	------	-------	---------	-------	-----	-----	----	---------------

Cable 0.3 m · with M8 connector (snap-fit) · Output function  · 3-wire DC PNP · 2-wire DC PNP/NPN · Wiring diagram no. 39 · Connector groups 1, 2, 3

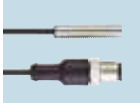

M8 / L = 37	3 f	Brass	10...30	IP 67	1000	100	38	IE5344
-------------	-----	-------	---------	-------	------	-----	----	---------------



M8 / L = 37	5 nf	Brass	10...30	IP 67	700	100	39	IE5346
-------------	------	-------	---------	-------	-----	-----	----	---------------

Cable 2 m · Output function  · 3-wire DC PNP · 2-wire DC PNP/NPN · Wiring diagram no. 41



M8 / L = 37	3 f	Brass	10...30	IP 67	1000	100	40	IE5343
-------------	-----	-------	---------	-------	------	-----	----	---------------



M8 / L = 37	5 nf	Brass	10...30	IP 67	700	100	39	IE5345
-------------	------	-------	---------	-------	-----	-----	----	---------------

Cable 2 m · Output function  · 3-wire · DC PNP · Wiring diagram no. 5



M8 / L = 35	1 f	Brass	10...36	IP 67	750	200	41	IE5072
-------------	-----	-------	---------	-------	-----	-----	----	---------------



M8 / L = 35	2 nf	PBT	10...36	IP 67	800	200	41	IE5099
-------------	------	-----	---------	-------	-----	-----	----	---------------



M8 / L = 50	1 f	Brass	10...36	IP 67	750	200	42	IE5121
-------------	-----	-------	---------	-------	-----	-----	----	---------------

You can find wiring diagrams and scale drawings from page 134











Position sensors



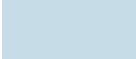

Type	Dimensions [mm]	Sensing range [mm]	Material	U _b [V]	Protection	f [Hz]	I _{load} [mA]	Draw- ing no.	Order no.
Cable 2 m · Output function  · 3-wire · DC PNP · Wiring diagram no. 5									
	M8 / L = 50	1 f	PBT	10...36	IP 67	1000	200	42	IE5129
	M8 / L = 20	1.5 f	stainless steel	10...30	IP 67	4000	200	43	IE5348
	M8 / L = 27	2 f	High-grade st. steel	10...30	IP 67	1500	100	44	IE5368
	M8 / L = 27	4 nf	High-grade st. steel	10...30	IP 67	500	100	45	IE5369
	M12 / L = 35	2 f	Brass	10...36	IP 67	1500	150	46	IF5188
	M12 / L = 35	4 nf	Brass	10...36	IP 67	1500	150	47	IF5249
	M12 / L = 71	2 f	Brass	10...55	IP 67	800	250	48	IF5297
	M12 / L = 71	2 f	PBT	10...55	IP 67	800	250	48	IF5313
	M12 / L = 71	4 nf	Brass	10...36	IP 67	1500	250	49	IF5329
	M12 / L = 71	4 nf	PBT	10...36	IP 67	400	250	48	IF5345
	M18 / L = 38	5 f	Brass	18...36	IP 67	500	125	50	IG5221
	M18 / L = 38	8 nf	Brass	18...36	IP 67	200	125	51	IG5285
	M18 / L = 80	5 f	Brass	10...36	IP 67	500	250	52	IG5397
	M18 / L = 80	8 nf	Brass	10...36	IP 67	300	250	53	IG5398
	M18 / L = 80	5 f	PBT	10...36	IP 67	500	250	52	IG5399
	M18 / L = 80	8 nf	PBT	10...36	IP 67	300	250	52	IG5401

Type	Dimensions [mm]	Sensing range [mm]	Material	U _b [V]	Protection	f [Hz]	I _{load} [mA]	Drawing no.	Order no.
------	--------------------	-----------------------	----------	-----------------------	------------	-----------	---------------------------	-------------	-----------

Cable 2 m · Output function  · 3-wire · DC PNP · Wiring diagram no. 5





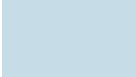





	M30 / L = 45	10 f	Brass	18...36	IP 67	300	125	54	I15166
	M30 / L = 81	10 f	Brass	10...36	IP 67	250	250	55	I15256
	M30 / L = 81	15 nf	Brass	10...36	IP 67	250	250	56	I15284
	M30 / L = 81	15 nf	PBT	10...36	IP 67	250	250	55	I15300
	M30 / L = 45	15 nf	Brass	18...36	IP 67	250	125	57	I15346
	M30 / L = 81	10 f	PBT	10...36	IP 67	250	250	55	I15369
	M5 / L = 30	0.8 f	stainless steel	10...36	IP 65	2000	100	58	IY5029
	M5 / L = 27	1.5 nf	stainless steel	10...30	IP 67	1800	100	59	IY5049
	M5 / L = 23	0.8 f	stainless steel	10...30	IP 65	2000	100	60	IY5051
	M5 / L = 23	1.2 f	stainless steel	10...30	IP 65	2000	100	60	IY5052

Cable 2 m · Output function  · 2-wire · DC PNP/NPN · Wiring diagram no. 42

	M8 / L = 50	2 nf	PBT (Pocan)	5...36	IP 67	2000	200	42	IE5202
	M8 / L = 50	1 f	Brass	5...36	IP 67	2000	200	42	IE5222
	M8 / L = 50	2 nf	Brass	5...36	IP 67	2700	200	61	IE5238
	M12 / L = 71	4 nf	PBT	10...55	IP 67	1500	400	48	IF5597
	M12 / L = 71	2 f	PBT	10...55	IP 67	1100	400	48	IF5644





Position sensors

Type	Dimensions [mm]	Sensing range [mm]	Material	U _b [V]	Protection	f [Hz]	I _{load} [mA]	Draw- ing no.	Order no.
Cable 2 m · Output function / · 2-wire · DC PNP/NPN · Wiring diagram no. 42									
	M12 / L = 71	2 f	Brass	10...55	IP 67	1100	400	48	IF5645
	M12 / L = 71	4 nf	Brass	10...55	IP 67	1500	400	49	IF5646
	M18 / L = 80	8 nf	PBT	10...55	IP 67	300	400	52	IG5533
	M18 / L = 80	5 f	PBT	10...55	IP 67	700	400	52	IG5593
	M18 / L = 80	5 f	Brass	10...55	IP 67	700	400	52	IG5594
	M18 / L = 80	8 nf	Brass	10...55	IP 67	300	400	53	IG5596
	M30 / L = 81	15 nf	PBT	10...55	IP 67	200	400	55	I15436
	M30 / L = 81	10 f	PBT	10...55	IP 67	450	400	55	I15488
	M30 / L = 81	10 f	Brass	10...55	IP 67	450	400	55	I15489
	M30 / L = 81	15 nf	Brass	10...55	IP 67	200	400	56	I15491
	M30 / L = 45	10 f	Brass	10...55	IP 67	450	400	54	I15493
M12 connector · Output function · 3-wire · DC PNP · Wiring diagram no. 2 · Connector groups 8, 10, 19, 21, 23, 25, 148, 149, 153, 184, 188, 193, 202									
	M12 / L = 45	2 f	Brass	10...30	IP 67	700	100	18	IF5214
	M12 / L = 50	4 nf	Brass	10...30	IP 67	700	100	19	IF5215
M12 connector · Output function · 3-wire · DC PNP · Wiring diagram no. 2 · Connector groups 8, 10, 11, 18, 19, 21, 23									
	M12 / L = 70	2 f	Brass	10...36	IP 67	700	100	12	IF5216
	M12 / L = 70	4 nf	Brass	10...36	IP 67	700	100	13	IF5217







Product selectors and further information can be found at: www.ifm.com

Type	Dimensions [mm]	Sensing range [mm]	Material	U _b [V]	Protection	f [Hz]	I _{load} [mA]	Drawing no.	Order no.
------	--------------------	-----------------------	----------	-----------------------	------------	-----------	---------------------------	-------------	-----------

M12 connector · Output function  · 3-wire · DC PNP · Wiring diagram no. 2 · Connector groups 8, 10, 19, 21, 23, 25, 148, 149, 153, 184, 188, 193, 202

	M18 / L = 45	5 f	Brass	10...30	IP 67	400	100	22	IGS214
---	--------------	-----	-------	---------	-------	-----	-----	----	---------------







M12 connector · Output function  · 3-wire · DC PNP · Wiring diagram no. 2 · Connector groups 8, 10, 11, 18, 19, 21, 23

	M18 / L = 70	5 f	Brass	10...36	IP 67	400	100	14	IGS216
	M18 / L = 70	8 nf	Brass	10...36	IP 67	300	100	15	IGS217
	M8 / L = 53	1 f	Brass	10...36	IP 67	750	200	62	IE5090
	M8 / L = 62	4 nf	Brass	10...36	IP 67	300	200	63	IE5288
	M8 / L = 62	2 f	Brass	10...36	IP 67	1000	250	64	IE5312
	M8 / L = 50	2 f	High-grade st. steel	10...36	IP 68 / IP 69K	1000	100	65	IE5379

M12 connector · Output function  · 3-wire · DC PNP · Wiring diagram no. 3 · Connector groups 8, 10, 19, 21, 23











	M8 / L = 62	2 f	Brass	10...36	IP 67	800	250	66	IE5327
---	-------------	-----	-------	---------	-------	-----	-----	----	---------------



M12 connector · Output function  · 2-wire · DC PNP/NPN · Wiring diagram no. 40 · Connector groups 8, 10, 19, 21, 23

	M8 / L = 69	1 f	Brass	5...36	IP 67	2700	200	67	IE5203
	M12 / L = 83	2 f	Brass	10...55	IP 67	1100	300	68	IF5598
	M12 / L = 83	4 nf	Brass	10...55	IP 67	1500	300	69	IF5647
	M18 / L = 70	5 f	Brass	10...55	IP 67	700	400	70	IG5595
	M18 / L = 76	8 nf	Brass	10...55	IP 67	300	400	71	IG5597
	M30 / L = 78	10 f	Brass	10...55	IP 67	450	400	72	I15490





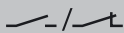





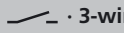

Position sensors

Type	Dimensions [mm]	Sensing range [mm]	Material	U _b [V]	Protection	f [Hz]	I _{load} [mA]	Draw- ing no.	Order no.
M12 connector · Output function · 2-wire · DC PNP/NPN · Wiring diagram no. 40 · Connector groups 8, 10, 19, 21, 23									
	M30 / L = 78	15 nf	Brass	10...55	IP 67	200	400	73	II5492
M8 connector · Output function · 3-wire DC PNP · 2-wire DC PNP/NPN · Wiring diagram no. 39 · Connector groups 1, 2, 3									
	M8 / L = 40	3 f	Brass	10...30	IP 65 / IP 67	800	100	74	IE5338
	M8 / L = 40	5 nf	High-grade st. steel	10...30	IP 65 / IP 67	600	100	75	IE5340
M8 connector · Output function · 3-wire · DC PNP · Wiring diagram no. 2 · Connector groups 1, 2, 3									
	M8 / L = 50	2 f	Brass	10...36	IP 65 / IP 67	1300	200	76	IE5287
	M8 / L = 30.5	2 f	High-grade st. steel	10...30	IP 65 / IP 67	800	100	77	IE5366
	M8 / L = 30.5	4 nf	High-grade st. steel	10...30	IP 65 / IP 67	800	100	78	IE5367
	M5 / L = 45	0.8 f	stainless steel	10...36	IP 65	2000	100	79	IY5036
	M5 / L = 41	1.5 nf	stainless steel	10...30	IP 67	1800	100	80	IY5048
M8 connector · Output function · 3-wire DC PNP · 2-wire DC PNP/NPN · Wiring diagram no. 43 · Connector groups 1, 2, 3									
	M8 / L = 40	3 f	Brass	10...30	IP 65 / IP 67	800	100	74	IE5349
	M8 / L = 40	5 nf	High-grade st. steel	10...30	IP 65 / IP 67	600	100	75	IE5350
M8 connector · Output function · 3-wire · DC PNP · Wiring diagram no. 7 · Connector groups 1, 2, 3									
	M8 / L = 50	1 f	Brass	10...36	IP 65 / IP 67	2000	200	76	IE5258

Type	Dimensions [mm]	Sensing range [mm]	Material	U _b [V]	Protection	f [Hz]	I _{load} [mA]	Drawing no.	Order no.
Terminals · Output function  · 2-wire · DC PNP/NPN · Wiring diagram no. 44									
	M18 / L = 110	5 f	PBT	10...55	IP 65	800	400	81	IG5718
	M18 / L = 110	8 nf	PBT	10...55	IP 65	300	400	81	IG5719





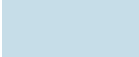













f = flush / nf = non flush / qf = quasi-flush



Sensors for industrial applications with smooth sleeve

Type	Dimensions [mm]	Sensing range [mm]	Material	U _b [V]	Protection	f [Hz]	I _{load} [mA]	Drawing no.	Order no.
Cable 2 m · Output function  · 3-wire · DC PNP · Wiring diagram no. 5									
	Ø 20 / L = 77	10 nf	PBT	10...36	IP 67	300	250	82	IA5082
	Ø 34 / L = 82	20 nf	PBT	10...36	IP 67	60	250	83	IB5096
	Ø 6.5 / L = 35	1 f	Brass	10...36	IP 67	900	200	84	IT5001
	Ø 6.5 / L = 19	2 f	stainless steel	10...30	IP 67	1000	200	85	IT5039
	Ø 6.5 / L = 27	2 f	High-grade st. steel	10...30	IP 67	1500	100	86	IT5042
	Ø 4 / L = 30	0.8 f	stainless steel	10...36	IP 65	2000	100	87	IZ5026
	Ø 4 / L = 27	1.5 nf	stainless steel	10...30	IP 67	1800	100	88	IZ5047
	Ø 3 / L = 27	1 nf	stainless steel	10...30	IP 67	5000	100	89	IZ5048
	Ø 4 / L = 23	0.8 f	stainless steel	10...30	IP 65	2000	100	90	IZ5051
	Ø 4 / L = 23	1.2 f	stainless steel	10...30	IP 65	2000	100	90	IZ5052





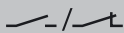



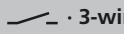
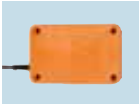

Position sensors

Type	Dimensions [mm]	Sensing range [mm]	Material	U _b [V]	Protection	f [Hz]	I _{load} [mA]	Draw- ing no.	Order no.
Cable 2 m · Output function  /  · 2-wire · DC PNP/NPN · Wiring diagram no. 42									
	Ø 20 / L = 77	10 nf	PBT	10...55	IP 67	300	400	82	IA5108
M12 connector · Output function  · 3-wire · DC PNP · Wiring diagram no. 2 · Connector groups 8, 10, 11, 18, 19, 21, 23									
	Ø 20 / L = 93	10 nf	PBT	10...36	IP 67	300	250	91	IA5127
M8 connector · Output function  · 3-wire · DC PNP · Wiring diagram no. 2 · Connector groups 1, 2, 3									
	Ø 4 / L = 41	1.5 nf	stainless steel	10...30	IP 67	1800	100	92	IZ5046
	Ø 6.5 / L = 50	1 f	Brass	10...36	IP 65 / IP 67	2000	200	93	IT5021
	Ø 6.5 / L = 50	1.5 f	Brass	10...36	IP 65 / IP 67	1700	200	93	IT5034
	Ø 6.5 / L = 30.5	2 f	High-grade st. steel	10...30	IP 65 / IP 67	800	100	94	IT5040
	Ø 6.5 / L = 50	4 nf	High-grade st. steel	10...30	IP 67	300	100	95	IT5044
	Ø 4 / L = 45	0.8 f	stainless steel	10...36	IP 65	2000	100	96	IZ5035
Terminals · Output function  · 3-wire · DC PNP · Wiring diagram no. 8									
	Ø 20 / L = 92	10 nf	PBT	10...36	IP 65	300	250	97	IA5062
Terminals · Output function  · 3-wire · DC PNP · Wiring diagram no. 8									
	Ø 20 / L = 92	10 nf	PBT	10...36	IP 65	300	250	97	IA5063
Terminals · Output function  /  · 2-wire · DC PNP/NPN · Wiring diagram no. 44									
	Ø 20 / L = 92	10 nf	PBT	10...55	IP 65	300	300	97	IA5122
	Ø 34 / L = 98	20 nf	PBT	10...55	IP 65	300	300	98	IB5124

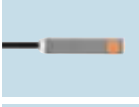
Type	Dimensions [mm]	Sensing range [mm]	Material	U _b [V]	Protection	f [Hz]	I _{load} [mA]	Drawing no.	Order no.
Terminals · Output function  · 3-wire · DC PNP · Wiring diagram no. 8									
	Ø 34 / L = 98	20 nf	PBT	10...36	IP 65	350	250	98	IB5063
	Ø 34 / L = 98	30 nf	PBT	10...36	IP 65	350	200	98	IB5133

f = flush / nf = non flush / qf = quasi-flush













Sensors for industrial applications, rectangular housings

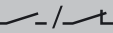

Type	Dimensions [mm]	Sensing range [mm]	Material	U _b [V]	Protection	f [Hz]	I _{load} [mA]	Drawing no.	Order no.
Cable 2 m · Output function  · 3-wire · DC PNP · Wiring diagram no. 5									
	120 x 80 x 30	50 nf	PPE	10...36	IP 67	100	250	99	ID5026
	40 x 8 x 8	2 f	Brass	10...36	IP 65	2000	250	100	IL5002
	40 x 8 x 8	2 f	Brass	10...36	IP 65	2000	250	101	IL5003
	40 x 8 x 8	2.5 f	Brass	10...36	IP 65	2000	250	100	IL5020
	25 x 5 x 5	0.8 f	aluminium	10...30	IP 67	1000	100	102	IL5022
	40 x 12 x 26	2 f	PBT	10...36	IP 67	1400	250	103	IN5121
	40 x 12 x 26	4 nf	PBT	10...36	IP 67	1300	250	103	IN5129
	28 x 10 x 16	2 f	PBT	10...30	IP 67	800	200	104	IS5001
	28 x 10 x 16	3 nf	PBT	10...30	IP 67	100	200	104	IS5031
	28 x 10 x 16	4 nf	PBT	10...36	IP 67	2000	250	105	IS5070
	60 x 36 x 10	5 f	PBT	10...36	IP 67	400	250	106	IW5051

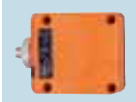
You can find wiring diagrams and scale drawings from page 134













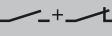

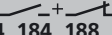

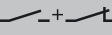

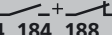
Position sensors

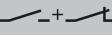
Type	Dimensions [mm]	Sensing range [mm]	Material	U _b [V]	Protection	f [Hz]	I _{load} [mA]	Draw- ing no.	Order no.
Cable 2 m · Output function  · 3-wire · DC PNP · Wiring diagram no. 5									
	60 x 36 x 10	8 nf	PBT	10...36	IP 67	300	250	106	IW5058
Cable 2 m · Output function  · 3-wire · DC PNP · Wiring diagram no. 9									
	40 x 12 x 26	2 f	PBT	10...36	IP 67	1400	250	103	IN5186
	40 x 12 x 26	4 nf	PBT	10...36	IP 67	1300	250	103	IN5188
	60 x 36 x 10	8 nf	PBT	10...36	IP 67	300	250	107	IW5053
Cable 2 m · Output function  · 2-wire · DC PNP/NPN · Wiring diagram no. 42									
	40 x 12 x 26	2 f	PBT	10...55	IP 67	1300	400	103	IN5207
	40 x 12 x 26	4 nf	PBT	10...55	IP 67	1200	300	103	IN5208
	28 x 10 x 16	2 f	PBT	5...36	IP 67	2000	200	104	IS5026
M12 connector · 2-wire · AS-i · Wiring diagram no. 10 · Connector groups 8, 10, 19, 21, 23									
	40 x 40 x 54	15 f	PBT	26.5...31.6	IP 67	100	–	7	IM5118
M12 connector · Output function  · 3-wire · DC PNP · Wiring diagram no. 2 · Connector groups 8, 10, 11, 18, 19, 21, 23									
	92 x 80 x 40	50 f	PPE	10...36	IP 67	70	250	108	ID5055
	40 x 40 x 54	20 f	PA (polyamide)	10...36	IP 67	100	200	7	IM5115
	40 x 40 x 54	35 nf	PA (polyamide)	10...36	IP 67	80	200	7	IM5116
	40 x 40 x 54	40 nf	PA (polyamide)	10...36	IP 67	60	200	7	IM5117
M12 connector · Output function  · 3-wire · DC PNP · Wiring diagram no. 2 · Connector groups 137, 138, 139, 140, 141									
	40 x 40 x 54	20 f	PA (polyamide)	10...36	IP 67	200	200	109	IM5119

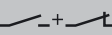
Type	Dimensions [mm]	Sensing range [mm]	Material	U _b [V]	Protection	f [Hz]	I _{load} [mA]	Draw- ing no.	Order no.
M12 connector · Output function  · 3-wire · DC PNP · Wiring diagram no. 2 · Connector groups 137, 138, 139, 140, 141									
	40 x 40 x 54	35 nf	PA (polyamide)	10...36	IP 67	200	200	109	IM5120
M12 connector · Output function  · 2-wire · DC PNP/NPN · Wiring diagram no. 48 · Connector groups 8, 10, 19, 21, 23									
	40 x 40 x 54	15 f	PA (polyamide)	10...36	IP 67	200	100	174	IM5127
M12 connector · Output function  · 3-wire · DC PNP · Wiring diagram no. 2 · Connector groups 8, 10, 11, 18, 19, 21, 23									
	40 x 40 x 54	20 f	PA (polyamide)	10...36	IP 67	200	200	7	IM5128
M12 connector · Output function  · 3-wire · DC PNP · Wiring diagram no. 2 · Connector groups 137, 138, 139, 140, 141									
	40 x 40 x 54	40 nf	PA (polyamide)	10...36	IP 67	200	200	109	IM5129
M12 connector · Output function  · 3-wire · DC PNP · Wiring diagram no. 2 · Connector groups 8, 10, 11, 18, 19, 21, 23									
	40 x 40 x 54	35 nf	PA (polyamide)	10...36	IP 67	200	200	7	IM5130
	40 x 40 x 54	40 nf	PA (polyamide)	10...36	IP 67	200	200	7	IM5131
M12 connector · Output function  · 3-wire · DC PNP · Wiring diagram no. 2 · Connector groups 8, 10, 11, 18, 19, 21, 23									
	105 x 80 x 40	60 nf	PPE	10...36	IP 67	100	250	110	ID5046
M12 connector · Output function  · 4-wire · DC PNP · Wiring diagram no. 11 · Connector groups 137, 138, 139, 140, 141									
	40 x 40 x 54	20 f	PA (polyamide)	10...36	IP 67	200	200	109	IM5124
	40 x 40 x 54	35 nf	PA (polyamide)	10...36	IP 67	200	200	109	IM5125
	40 x 40 x 54	40 nf	PA (polyamide)	10...36	IP 67	200	200	109	IM5126
M12 connector · Output function  · 4-wire · DC PNP · Wiring diagram no. 11 · Connector groups 8, 10, 11, 18, 19, 21, 23									
	92 x 80 x 40	50 f	PPE	10...36	IP 67	70	250	108	ID5058



Position sensors

Type	Dimensions [mm]	Sensing range [mm]	Material	U _b [V]	Protection	f [Hz]	I _{load} [mA]	Drawing no.	Order no.
M12 connector · Output function  · 4-wire · DC PNP · Wiring diagram no. 11 · Connector groups 137, 138, 139, 140, 141									
	40 x 40 x 54	20 f	PA (polyamide)	10...36	IP 67	200	200	7	IM5132
M12 connector · Output function  · 4-wire · DC PNP · Wiring diagram no. 11 · Connector groups 8, 9, 10, 11, 18, 19, 21, 23, 25, 148, 149, 150, 151, 153, 154, 184, 188, 190, 193, 202, 203, 204									
	40 x 40 x 54	35 nf	PA (polyamide)	10...36	IP 67	200	200	7	IM5133
M12 connector · Output function  · 4-wire · DC PNP · Wiring diagram no. 11 · Connector groups 8, 10, 11, 18, 19, 21, 23									
	40 x 40 x 54	35 nf	PA (polyamide)	10...36	IP 67	80	200	7	IM5134
M12 connector · Output function  · 4-wire · DC PNP · Wiring diagram no. 11 · Connector groups 8, 9, 10, 11, 18, 19, 21, 23, 25, 148, 149, 150, 151, 153, 154, 184, 188, 190, 193, 202, 203, 204									
	40 x 40 x 54	40 nf	PA (polyamide)	10...36	IP 67 / IP 69K	200	200	7	IM5135
M12 connector · Output function  · 4-wire · DC PNP · Wiring diagram no. 11 · Connector groups 8, 10, 11, 18, 19, 21, 23									
	40 x 40 x 54	40 nf	PA (polyamide)	10...36	IP 67	60	200	7	IM5136
M12 connector · Output function  · 4-wire · DC PNP · Wiring diagram no. 11 · Connector groups 8, 10, 19, 21, 23									
	40 x 40 x 54	20 f	PA (polyamide)	10...36	IP 67	100	200	7	IM5123
M8 connector · Output function  · 3-wire · DC PNP · Wiring diagram no. 2 · Connector groups 1, 2, 3									
	40 x 8 x 8	2 f	Brass	10...36	IP 65	2000	250	111	IL5004
	40 x 8 x 8	2 f	Brass	10...36	IP 65	2000	250	112	IL5005
	40 x 12 x 26	4 nf	PBT	10...36	IP 65	1300	250	113	IN5212
	40 x 12 x 26	2 f	PBT	10...36	IP 67	1400	250	113	IN5230
	28 x 10 x 16	2 f	PBT	10...36	IP 67	800	200	114	IS5035
	28 x 10 x 16	4 nf	PBT	10...36	IP 67	2000	250	114	IS5071

Type	Dimensions [mm]	Sensing range [mm]	Material	U _b [V]	Protection	f [Hz]	I _{load} [mA]	Drawing no.	Order no.
M8 connector · Output function  · 3-wire · DC PNP · Wiring diagram no. 2 · Connector groups 1, 2, 3									
	60 x 36 x 10	8 nf	PBT	10...36	IP 65	300	250	115	IW5064
M8 connector · Output function  · 3-wire · DC PNP · Wiring diagram no. 7 · Connector groups 1, 2, 3									
	60 x 36 x 10	8 nf	PBT	10...36	IP 67	300	250	115	IW5062
Terminals · Output function  · 2-wire · DC PNP/NPN · Wiring diagram no. 44									
	40 x 40 x 120	15 f	PPE	10...55	IP 65	350	400	116	IM5037
	40 x 40 x 120	20 nf	PPE	10...55	IP 65	300	400	116	IM5038
Terminals · Output function  · 3-wire · DC PNP · Wiring diagram no. 8									
	40 x 40 x 120	20 nf	PPE	10...36	IP 65	350	250	116	IM5019
	40 x 40 x 120	15 f	PPE	10...36	IP 65	350	250	116	IM5020
	40 x 40 x 120	30 nf	PPE	10...36	IP 65	100	250	116	IM5046
Terminals · Output function  · 3-wire · DC PNP · Wiring diagram no. 45									
	90 x 60 x 40	40 nf	PPE	10...36	IP 65	15	250	117	IC5005
	105 x 80 x 40	60 nf	PPE	10...36	IP 65	100	250	118	ID5005
Terminals · Output function  · 3-wire · DC PNP · Wiring diagram no. 12									
	40 x 40 x 118	20 f	PA 6.6	10...30	IP 68 / IP 69K	400	200	119	IV5004
M12 connector · Output function  · 3-wire · DC PNP · Wiring diagram no. 2 · Connector groups 8, 10, 11, 18, 19, 21, 23, 25, 148, 149, 150, 153, 154, 184, 188, 190, 193, 202, 203, 204									
	40 x 40 x 118	20 f	PA 6.6	10...30	IP 68 / IP 69K	5	200	120	IV5060

f = flush / nf = non flush / qf = quasi-flush



Position sensors

Sensors for industrial applications, AC and AC/DC

Type	Dimensions [mm]	Sensing range [mm]	Material	U _b [V]	Protection	f AC / DC [Hz]	I _{load} AC / DC [mA]	Drawing no.	Order no.
------	--------------------	-----------------------	----------	-----------------------	------------	----------------------	--------------------------------------	-------------	-----------









1/2" connector · Output function  · 2-wire · AC/DC · Wiring diagram no. 13 · Connector group 33

	40 x 40 x 66	35 nf	PPE	20...250	IP 67	20 / 50	250 / 100	121	IM0049*
---	--------------	-------	-----	----------	-------	---------	-----------	-----	----------------

Cable 2 m · Output function  · 2-wire · AC · Wiring diagram no. 4

	M12 / L = 71.5	2 f	PBT	20...250	IP 67	25	200	122	IF0001*
	M12 / L = 71.5	4 nf	PBT	20...250	IP 67	25	200	122	IF0003*
	M12 / L = 71.5	2 f	Brass	20...250	IP 67	25	200	122	IF0005*
	M12 / L = 71	4 nf	Brass	20...250	IP 67	25	200	123	IF0007*

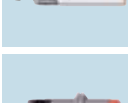
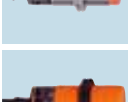
Cable 2 m · Output function  · 2-wire · AC/DC · Wiring diagram no. 14

	Ø 20 / L = 77	10 nf	PBT	20...250	IP 67	25 / 70	250 / 100	82	IA0004*
	Ø 34 / L = 82	20 nf	PBT	20...250	IP 67	25 / 50	250 / 100	83	IB0004*
	Ø 34 / L = 82	30 nf	PBT	20...250	IP 67	25 / 50	250 / 100	83	IB0026*
	120 x 80 x 30	50 nf	modified PPE	20...250	IP 65	25 / 35	250 / 100	99	ID0014*
	M18 / L = 80	5 f	PBT	20...250	IP 67	25 / 50	250 / 100	52	IG0005*
	M18 / L = 80	8 nf	PBT	20...250	IP 67	25 / 50	250 / 100	52	IG0006*
	M18 / L = 80	5 f	Brass	20...250	IP 67	25 / 50	250 / 100	52	IG0011*
	M18 / L = 80	8 nf	Brass	20...250	IP 67	25 / 50	250 / 100	53	IG0012*
	M30 / L = 81	10 f	PBT	20...250	IP 67	25 / 50	250 / 100	55	I10005*

Type	Dimensions [mm]	Sensing range [mm]	Material	U _b [V]	Protection	f AC / DC [Hz]	I _{load} AC / DC [mA]	Draw- ing no.	Order no.
Cable 2 m · Output function  · 2-wire · AC/DC · Wiring diagram no. 14									
	M30 / L = 81	15 nf	PBT	20...250	IP 67	25 / 50	250 / 100	55	II0006*
	M30 / L = 81	10 f	Brass	20...250	IP 67	25 / 50	250 / 100	55	II0011*
	M30 / L = 81	15 nf	Brass	20...250	IP 67	25 / 50	250 / 100	56	II0012*
	40 x 12 x 26	2 f	PBT	20...250	IP 67	25 / 50	250 / 100	103	IN0073*
	40 x 12 x 26	4 nf	PBT	20...250	IP 67	25 / 50	250 / 100	103	IN0081*
Cable 2 m · Output function  · 2-wire · AC/DC · Wiring diagram no. 15									
	∅ 20 / L = 77	10 nf	PBT	20...250	IP 67	25 / 70	250 / 100	82	IA0027*
	∅ 34 / L = 82	20 nf	PBT	20...250	IP 67	25 / 50	250 / 100	83	IB0017*
	∅ 34 / L = 82	30 nf	PBT	20...250	IP 67	25 / 50	250 / 100	83	IB0027*
	40 x 12 x 26	2 f	PBT	20...250	IP 67	25 / 50	250 / 100	103	IN0077*
	40 x 12 x 26	4 nf	PBT	20...250	IP 67	25 / 50	250 / 100	103	IN0085*
M12 connector · Output function  · 2-wire · AC/DC · Wiring diagram no. 13 · Connector group 7									
	40 x 40 x 66	35 nf	PPE	20...250	IP 67	20 / 50	250 / 100	124	IM0053*
	92 x 80 x 40	50 f	modified PPE	20...250	IP 67	25	250 / 100	108	ID0049*
	40 x 40 x 66	20 f	PPE	20...250	IP 67	25 / 140	250 / 100	124	IM0054*
Terminals · Output function  /  · 2-wire · AC/DC · Wiring diagram no. 46									
	90 x 60 x 40	40 nf	PPE	20...250	IP 65	10	250 / 100	117	IC0003*



Position sensors

Type	Dimensions [mm]	Sensing range [mm]	Material	U _b [V]	Protection	f AC / DC [Hz]	I _{load} AC / DC [mA]	Drawing no.	Order no.
------	--------------------	-----------------------	----------	-----------------------	------------	----------------------	--------------------------------------	-------------	-----------

Terminals · Output function · 2-wire · AC/DC · Wiring diagram no. 46

	105 x 80 x 40	60 nf	modified PPE	20...250	IP 65	4	250 / 100	118	ID0013*
--	---------------	-------	--------------	----------	-------	---	-----------	-----	----------------

Terminals · Output function · 2-wire · AC/DC · Wiring diagram no. 16

	∅ 20 / L = 92	10 nf	PBT	20...250	IP 65	25 / 70	250 / 100	97	IA0032*
--	---------------	-------	-----	----------	-------	---------	-----------	----	----------------

	∅ 34 / L = 98	20 nf	PBT	20...250	IP 65	25 / 50	250 / 100	98	IB0016*
--	---------------	-------	-----	----------	-------	---------	-----------	----	----------------

	40 x 40 x 120	20 nf	PPE	20...250	IP 65	20 / 55	250 / 100	116	IM0010*
--	---------------	-------	-----	----------	-------	---------	-----------	-----	----------------

	40 x 40 x 120	15 f	PPE	20...250	IP 65	20 / 55	250 / 100	116	IM0011*
--	---------------	------	-----	----------	-------	---------	-----------	-----	----------------

f = flush / nf = non flush / qf = quasi-flush

* Note on use of miniature fuses for electrical connection

Miniature fuse to IEC60127-2 sheet 1, ≤ 2 A (fast acting) Recommendation: check the unit for reliable function after a short circuit.

Sensors for industrial applications with analogue output 4...20 mA

Type	Dimensions [mm]	Sensing range [mm]	Material	U _b [V]	Protection	f [Hz]	I _{load} [mA]	Drawing no.	Order no.
------	--------------------	-----------------------	----------	-----------------------	------------	-----------	---------------------------	-------------	-----------

M12 connector · Output function 4...20 mA analogue · 3-wire · DC analogue · Wiring diagram no. 17 · Connector groups 8, 10, 19, 21, 23

	M12 / L = 70	0.2...2 f	Brass	15...30	IP 67	–	–	12	IF6028
--	--------------	-----------	-------	---------	-------	---	---	----	---------------

	M12 / L = 70	0.4...4 nf	Brass	15...30	IP 67	–	–	13	IF6030
--	--------------	------------	-------	---------	-------	---	---	----	---------------

	M18 / L = 60	0.8...8 nf	Brass	15...30	IP 67	–	–	125	IG6083
--	--------------	------------	-------	---------	-------	---	---	-----	---------------

	M18 / L = 60	0.5...5 f	Brass	15...30	IP 67	–	–	126	IG6086
--	--------------	-----------	-------	---------	-------	---	---	-----	---------------

	M30 / L = 70	1.0...15 nf	Brass	15...30	IP 67	–	–	17	IIS913
--	--------------	-------------	-------	---------	-------	---	---	----	---------------

Type	Dimensions [mm]	Sensing range [mm]	Material	U _b [V]	Protection	f [Hz]	I _{load} [mA]	Drawing no.	Order no.
------	--------------------	-----------------------	----------	-----------------------	------------	-----------	---------------------------	-------------	-----------

M12 connector · Output function 4...20 mA analogue · 3-wire · DC analogue · Wiring diagram no. 17 · Connector groups 8, 10, 19, 21, 23







	M30 / L = 70	1.0...10 f	Brass	15...30	IP 67	–	–	16	IIS916
	40 x 40 x 54	1...15 f	PA (polyamide)	15...30	IP 67	–	–	7	IM5139
	40 x 40 x 54	1...26 nf	PA (polyamide)	15...30	IP 67	–	–	7	IM5141

f = flush / nf = non flush / qf = quasi-flush

Sensors for industrial applications with analogue output 0...10 V

Type	Dimensions [mm]	Sensing range [mm]	Material	U _b [V]	Protection	f [Hz]	I _{load} [mA]	Drawing no.	Order no.
------	--------------------	-----------------------	----------	-----------------------	------------	-----------	---------------------------	-------------	-----------

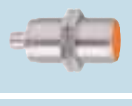
M12 connector · Output function 0...10 V analogue · 3-wire · DC analogue · Wiring diagram no. 17 · Connector groups 8, 10, 19, 21, 23







	M12 / L = 70	0.2...2 f	Brass	15...30	IP 67	–	–	12	IF6029
	M12 / L = 70	0.4...4 nf	Brass	15...30	IP 67	–	–	13	IF6031
	M18 / L = 60	0.8...8 nf	Brass	15...30	IP 67	–	–	125	IG6084
	M18 / L = 60	0.5...5 f	Brass	15...30	IP 67	–	–	126	IG6087
	M30 / L = 70	1.0...15 nf	Brass	15...30	IP 67	–	–	17	IIS914
	M30 / L = 70	1.0...10 f	Brass	15...30	IP 67	–	–	16	IIS917
	40 x 40 x 54	1...15 f	PA (polyamide)	15...30	IP 67	–	–	7	IM5140
	40 x 40 x 54	1...26 nf	PA (polyamide)	15...30	IP 67	–	–	7	IM5142

f = flush / nf = non flush / qf = quasi-flush





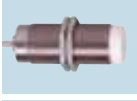
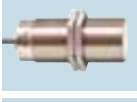



Position sensors







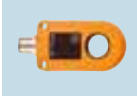

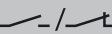

Sensors for industrial high temperature applications

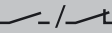
Type	Dimensions [mm]	Sensing range [mm]	Material	U _b [V]	Protection	f [Hz]	I _{load} [mA]	Drawing no.	Order no.
Cable 5 m · Output function  · 3-wire · DC PNP · Wiring diagram no. 5									
	M12 / L = 56	3 f	stainless steel	10...35	IP 65	500	120	127	IF6074
	M18 / L = 77	8 nf	stainless steel	10...35	IP 65	400	150	128	IG6119
	M18 / L = 70	5 f	stainless steel	10...35	IP 65	400	150	129	IG6614
	M30 / L = 79	15 nf	stainless steel	10...35	IP 65	200	150	130	II5930
	M30 / L = 70	10 f	High-grade st. steel	10...35	IP 65	200	150	131	II5961
	M50 / L = 70	20 f	stainless steel	10...35	IP 65	100	150	132	I95045



f = flush / nf = non flush / qf = quasi-flush

Sensors for industrial applications on pipes and tubes

Type	Inside diameter [mm]	Operating principle	Minimum diameter of the steel ball [Ø mm]	Part speed max. [m/s]	Pulse stretching [ms]	Response time / break time [ms]	Drawing no.	Order no.
M12 connector · Output function  /  · 3-wire · DC NPN · Wiring diagram no. 18 · Connector groups 8, 10, 19, 21, 23								
	10.1	static	1.5	35	10...150	0.5 / 10	133	I7R202
	10.1	dynamic	0.6	35	0.1...150	0.2 / 0.2	133	I7R204
	15.1	static	2	35	10...150	0.5 / 10	134	I7R206
	15.1	dynamic	0.8	35	0.1...150	0.2 / 0.2	134	I7R208
	20.1	static	2.5	35	10...150	0.5 / 10	135	I7R210
	20.1	dynamic	1.0	35	0.1...150	0.2 / 0.2	135	I7R212

Type	Inside diameter [mm]	Operating principle	Minimum diameter of the steel ball [Ø mm]	Part speed max. [m/s]	Pulse stretching [ms]	Response time / break time [ms]	Drawing no.	Order no.
M12 connector · Output function  · 3-wire · DC NPN · Wiring diagram no. 18 · Connector groups 8, 10, 19, 21, 23								
	25.1	static	3.0	35	10...150	0.5 / 10	136	I7R214
	25.1	dynamic	1.2	35	0.1...150	0.2 / 0.2	136	I7R216
M12 connector · Output function  · 3-wire · DC PNP · Wiring diagram no. 19 · Connector groups 8, 10, 11, 18, 19, 21, 23								
	10.1	static	1.5	35	10...150	0.5 / 10	133	I7R201
	10.1	dynamic	0.6	35	0.1...150	0.2 / 0.2	133	I7R203
	15.1	static	2	35	10...150	0.5 / 10	134	I7R205
	15.1	dynamic	0.8	35	0.1...150	0.2 / 0.2	134	I7R207
	20.1	static	2.5	35	10...150	0.5 / 10	135	I7R209
	20.1	dynamic	1.0	35	0.1...150	0.2 / 0.2	135	I7R211
	25.1	static	3.0	35	10...150	0.5 / 10	136	I7R213
	25.1	dynamic	1.2	35	0.1...150	0.2 / 0.2	136	I7R215
	51	static	6	35	10...150	0.5 / 10	137	I7R217

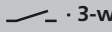
Tube sensors for industrial applications

Type	Sensing range [mm]	Operating principle	Minimum diameter of the steel ball [Ø mm]	Part speed max. [m/s]	Pulse stretching [ms]	Response time / break time [ms]	Drawing no.	Order no.
Cable 0.09 m · with M12 connector · Output function  · 3-wire · DC NPN · Wiring diagram no. 18 · Connector groups 8, 10, 19, 21, 23, 25, 148, 149, 153, 184, 188, 193, 202								
	≤ 14	static	3.0	35	100	0.5 / 100	138	I85003



Position sensors

Type	Sensing range [mm]	Operating principle	Minimum diameter of the steel ball [Ø mm]	Part speed max. [m/s]	Pulse stretching [ms]	Response time / break time [ms]	Draw- ing no.	Order no.
------	-----------------------	---------------------	--	--------------------------	--------------------------	------------------------------------	------------------	-----------

Cable 0.09 m · with M12 connector · Output function · 3-wire · DC PNP · Wiring diagram no. 19 · Connector groups 8, 10, 11, 18, 19, 21, 23, 25, 148, 149, 150, 153, 154, 184, 188, 190, 193, 202, 203, 204



≤ 14 static 3.0 35 100 0.5 / 100 138 **185002**

M8 connector · Output function · 3-wire · DC NPN · Wiring diagram no. 18 · Connector groups 1, 3, 78, 84, 145



≤ 14 static 3.0 35 100 0.5 / 100 139 **185001**

M8 connector · Output function · 3-wire · DC PNP · Wiring diagram no. 19 · Connector groups 1, 2, 3, 78, 84, 145, 146



≤ 14 static 3.0 35 100 0.5 / 100 139 **185000**

Sensors for industrial applications, oils and coolants and mobile applications with increased sensing range

Type	Dimensions [mm]	Sensing range [mm]	Material	U _b [V]	Protection	f [Hz]	I _{load} [mA]	Draw- ing no.	Order no.
------	--------------------	-----------------------	----------	-----------------------	------------	-----------	---------------------------	------------------	-----------

Cable 2 m · Output function · 3-wire · DC NPN · Wiring diagram no. 20

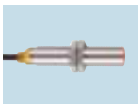

M12 / L = 60 4 f Brass 10...30 IP 65 / IP 66 / IP 67 / IP 68 / IP 69K 700 100 140 **IFS254**

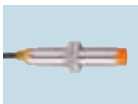

M12 / L = 60 7 nf Brass 10...30 IP 65 / IP 66 / IP 67 / IP 68 / IP 69K 700 100 141 **IFS255**

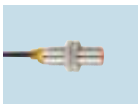

M12 / L = 40 4 f Brass 10...30 IP 65 / IP 66 / IP 67 / IP 68 / IP 69K 700 100 142 **IFS258**

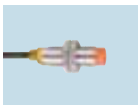

M12 / L = 40 7 nf Brass 10...30 IP 65 / IP 66 / IP 67 / IP 68 / IP 69K 700 100 143 **IFS259**

Cable 2 m · Output function · 3-wire · DC PNP · Wiring diagram no. 9

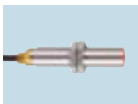

M12 / L = 60 4 f Brass 10...30 IP 65 / IP 66 / IP 67 / IP 68 / IP 69K 700 100 140 **IFS280**

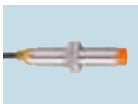

M12 / L = 60 7 nf Brass 10...30 IP 65 / IP 66 / IP 67 / IP 68 / IP 69K 700 100 141 **IFS282**

Cable 2 m · Output function · 3-wire · DC NPN · Wiring diagram no. 21

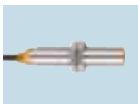

M12 / L = 60 4 f Brass 10...30 IP 65 / IP 66 / IP 67 / IP 68 / IP 69K 700 100 140 **IFS281**

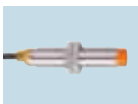







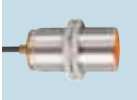

M12 / L = 60 7 nf Brass 10...30 IP 65 / IP 66 / IP 67 / IP 68 / IP 69K 700 100 141 **IFS283**

Type	Dimensions [mm]	Sensing range [mm]	Material	U _b [V]	Protection	f [Hz]	I _{load} [mA]	Drawing no.	Order no.
Cable 2 m · Output function  · 3-wire · DC NPN · Wiring diagram no. 20									
	M18 / L = 60	8 f	Brass	10...30	IP 65 / IP 66 / IP 67 / IP 68 / IP 69K	400	100	144	IGS246
	M18 / L = 60	12 nf	Brass	10...30	IP 65 / IP 66 / IP 67 / IP 68 / IP 69K	300	100	145	IGS247
	M18 / L = 40	8 f	Brass	10...30	IP 65 / IP 66 / IP 67 / IP 68 / IP 69K	400	100	146	IGS250
	M18 / L = 40	12 nf	Brass	10...30	IP 65 / IP 66 / IP 67 / IP 68 / IP 69K	300	100	147	IGS251
Cable 2 m · Output function  · 3-wire · DC PNP · Wiring diagram no. 9									
	M18 / L = 60	8 f	Brass	10...30	IP 65 / IP 66 / IP 67 / IP 68 / IP 69K	400	100	144	IGS269
	M18 / L = 60	12 nf	Brass	10...30	IP 65 / IP 66 / IP 67 / IP 68 / IP 69K	300	100	145	IGS270
Cable 2 m · Output function  · 3-wire · DC NPN · Wiring diagram no. 21									
	M18 / L = 60	8 f	Brass	10...30	IP 65 / IP 66 / IP 67 / IP 68 / IP 69K	400	100	144	IGS271
	M18 / L = 60	12 nf	Brass	10...30	IP 65 / IP 66 / IP 67 / IP 68 / IP 69K	300	100	145	IGS272
Cable 2 m · Output function  · 3-wire · DC NPN · Wiring diagram no. 20									
	M30 / L = 60	15 f	Brass	10...30	IP 65 / IP 66 / IP 67 / IP 68 / IP 69K	100	100	148	IIS240
	M30 / L = 60	22 nf	Brass	10...30	IP 65 / IP 66 / IP 67 / IP 68 / IP 69K	100	100	149	IIS241
	M30 / L = 45	15 f	Brass	10...30	IP 65 / IP 66 / IP 67 / IP 68 / IP 69K	100	100	150	IIS244
	M30 / L = 45	22 nf	Brass	10...30	IP 65 / IP 66 / IP 67 / IP 68 / IP 69K	100	100	151	IIS245
Cable 2 m · Output function  · 3-wire · DC PNP · Wiring diagram no. 9									
	M30 / L = 60	15 f	Brass	10...30	IP 65 / IP 66 / IP 67 / IP 68 / IP 69K	100	100	148	IIS264

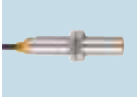
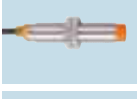
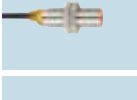
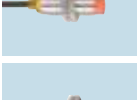

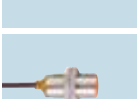
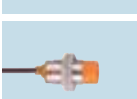
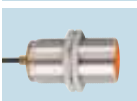
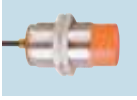
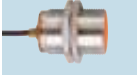

Position sensors





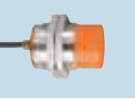





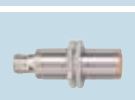

Type	Dimensions [mm]	Sensing range [mm]	Material	U _b [V]	Protection	f [Hz]	I _{load} [mA]	Drawing no.	Order no.
Cable 2 m · Output function  · 3-wire · DC PNP · Wiring diagram no. 9									
	M30 / L = 60	22 nf	Brass	10...30	IP 65 / IP 66 / IP 67 / IP 68 / IP 69K	100	100	149	IIS263
Cable 2 m · Output function  · 3-wire · DC NPN · Wiring diagram no. 21									
	M30 / L = 60	15 f	Brass	10...30	IP 65 / IP 66 / IP 67 / IP 68 / IP 69K	100	100	148	IIS265
	M30 / L = 60	22 nf	Brass	10...30	IP 65 / IP 66 / IP 67 / IP 68 / IP 69K	100	100	149	IIS266
Cable 2 m · Output function  · 3-wire · DC PNP · Wiring diagram no. 5									
	M12 / L = 60	4 f	Brass	10...30	IP 65 / IP 66 / IP 67 / IP 68 / IP 69K	700	100	140	IFS252
	M12 / L = 60	7 nf	Brass	10...30	IP 65 / IP 66 / IP 67 / IP 68 / IP 69K	700	100	141	IFS253
	M12 / L = 40	4 f	Brass	10...30	IP 65 / IP 66 / IP 67 / IP 68 / IP 69K	700	100	142	IFS256
	M12 / L = 40	7 nf	Brass	10...30	IP 65 / IP 66 / IP 67 / IP 68 / IP 69K	700	100	143	IFS257
	M18 / L = 60	8 f	Brass	10...30	IP 65 / IP 66 / IP 67 / IP 68 / IP 69K	400	100	144	IGS244
	M18 / L = 60	12 nf	Brass	10...30	IP 65 / IP 66 / IP 67 / IP 68 / IP 69K	300	100	145	IGS245
	M18 / L = 40	8 f	Brass	10...30	IP 65 / IP 66 / IP 67 / IP 68 / IP 69K	400	100	146	IGS248
	M18 / L = 40	12 nf	Brass	10...30	IP 65 / IP 66 / IP 67 / IP 68 / IP 69K	300	100	147	IGS249
	M30 / L = 60	15 f	Brass	10...30	IP 65 / IP 66 / IP 67 / IP 68 / IP 69K	100	100	148	IIS238
	M30 / L = 60	22 nf	Brass	10...30	IP 65 / IP 66 / IP 67 / IP 68 / IP 69K	100	100	149	IIS239
	M30 / L = 45	15 f	Brass	10...30	IP 65 / IP 66 / IP 67 / IP 68 / IP 69K	100	100	150	IIS242

Type	Dimensions [mm]	Sensing range [mm]	Material	U _b [V]	Protection	f [Hz]	I _{load} [mA]	Drawing no.	Order no.
------	--------------------	-----------------------	----------	-----------------------	------------	-----------	---------------------------	-------------	-----------

Cable 2 m · Output function  · 3-wire · DC PNP · Wiring diagram no. 5

	M30 / L = 45	22 nf	Brass	10...30	IP 65 / IP 66 / IP 67 / IP 68 / IP 69K	100	100	151	IIS243
---	--------------	-------	-------	---------	--	-----	-----	-----	---------------

M12 connector · Output function  · 3-wire · DC NPN · Wiring diagram no. 22 · Connector groups 8, 10, 19, 21, 23, 202

	M12 / L = 60	4 f	Brass	10...30	IP 65 / IP 66 / IP 67 / IP 68 / IP 69K	700	100	1	IFS242
	M12 / L = 60	7 nf	Brass	10...30	IP 65 / IP 66 / IP 67 / IP 68 / IP 69K	700	100	2	IFS243
	M12 / L = 45	4 f	Brass	10...30	IP 65 / IP 66 / IP 67 / IP 68 / IP 69K	700	100	18	IFS246
	M12 / L = 45	7 nf	Brass	10...30	IP 65 / IP 66 / IP 67 / IP 68 / IP 69K	700	100	152	IFS247
	M18 / L = 60	8 f	Brass	10...30	IP 65 / IP 66 / IP 67 / IP 68 / IP 69K	400	100	3	IGS234
	M18 / L = 60	12 nf	Brass	10...30	IP 65 / IP 66 / IP 67 / IP 68 / IP 69K	300	100	4	IGS235
	M18 / L = 45	8 f	Brass	10...30	IP 65 / IP 66 / IP 67 / IP 68 / IP 69K	400	100	22	IGS238
	M18 / L = 45	12 nf	Brass	10...30	IP 65 / IP 66 / IP 67 / IP 68 / IP 69K	300	100	153	IGS239
	M30 / L = 60	15 f	Brass	10...30	IP 65 / IP 66 / IP 67 / IP 68 / IP 69K	100	100	154	IIS228
	M30 / L = 60	22 nf	Brass	10...30	IP 65 / IP 66 / IP 67 / IP 68 / IP 69K	100	100	155	IIS229
	M30 / L = 50	15 f	Brass	10...30	IP 65 / IP 66 / IP 67 / IP 68 / IP 69K	100	100	156	IIS232
	M30 / L = 50	22 nf	Brass	10...30	IP 65 / IP 66 / IP 67 / IP 68 / IP 69K	100	100	157	IIS233

M12 connector · Output function  · 3-wire · DC PNP · Wiring diagram no. 2 · Connector groups 8, 10, 19, 21, 23, 202

	M12 / L = 45	7 nf	Brass	10...30	IP 65 / IP 66 / IP 67 / IP 68 / IP 69K	700	100	152	IFS245
---	--------------	------	-------	---------	--	-----	-----	-----	---------------









Position sensors

Type	Dimensions [mm]	Sensing range [mm]	Material	U _b [V]	Protection	f [Hz]	I _{load} [mA]	Draw- ing no.	Order no.
M12 connector · Output function  · 3-wire · DC PNP · Wiring diagram no. 2 · Connector groups 8, 10, 19, 21, 23, 202									
	M12 / L = 60	4 f	Brass	10...30	IP 65 / IP 66 / IP 67 / IP 68 / IP 69K	700	100	1	IFS240
	M12 / L = 60	7 nf	Brass	10...30	IP 65 / IP 66 / IP 67 / IP 68 / IP 69K	700	100	2	IFS241
	M18 / L = 60	8 f	Brass	10...30	IP 65 / IP 66 / IP 67 / IP 68 / IP 69K	400	100	3	IGS232
	M18 / L = 60	12 nf	Brass	10...30	IP 65 / IP 66 / IP 67 / IP 68 / IP 69K	300	100	4	IGS233
	M18 / L = 45	8 f	Brass	10...30	IP 65 / IP 66 / IP 67 / IP 68 / IP 69K	400	100	22	IGS236
	M18 / L = 45	12 nf	Brass	10...30	IP 65 / IP 66 / IP 67 / IP 68 / IP 69K	300	100	153	IGS237
	M30 / L = 60	15 f	Brass	10...30	IP 65 / IP 66 / IP 67 / IP 68 / IP 69K	100	100	154	IIS226
	M30 / L = 60	22 nf	Brass	10...30	IP 65 / IP 66 / IP 67 / IP 68 / IP 69K	100	100	155	IIS227
	M30 / L = 50	15 f	Brass	10...30	IP 65 / IP 66 / IP 67 / IP 68 / IP 69K	100	100	156	IIS230
	M30 / L = 50	22 nf	Brass	10...30	IP 65 / IP 66 / IP 67 / IP 68 / IP 69K	100	100	157	IIS231
	M12 / L = 45	4 f	Brass	10...30	IP 65 / IP 66 / IP 67 / IP 68 / IP 69K	700	100	18	IFS244
M12 connector · Output function  · 3-wire · DC NPN · Wiring diagram no. 23 · Connector groups 8, 10, 19, 21, 23, 202									
	M12 / L = 60	4 f	Brass	10...30	IP 65 / IP 66 / IP 67 / IP 68 / IP 69K	700	100	1	IFS249
	M12 / L = 60	7 nf	Brass	10...30	IP 65 / IP 66 / IP 67 / IP 68 / IP 69K	700	100	2	IFS251
	M12 / L = 45	4 f	Brass	10...30	IP 65 / IP 66 / IP 67 / IP 68 / IP 69K	700	100	18	IFS262
	M12 / L = 45	7 nf	Brass	10...30	IP 65 / IP 66 / IP 67 / IP 68 / IP 69K	700	100	152	IFS263

Type	Dimensions [mm]	Sensing range [mm]	Material	U _b [V]	Protection	f [Hz]	I _{load} [mA]	Drawing no.	Order no.
M12 connector · Output function  · 3-wire · DC NPN · Wiring diagram no. 23 · Connector groups 8, 10, 19, 21, 23, 202									
	M18 / L = 60	8 f	Brass	10...30	IP 65 / IP 66 / IP 67 / IP 68 / IP 69K	400	100	3	IGS241
	M18 / L = 60	12 nf	Brass	10...30	IP 65 / IP 66 / IP 67 / IP 68 / IP 69K	300	100	4	IGS243
	M18 / L = 45	8 f	Brass	10...30	IP 65 / IP 66 / IP 67 / IP 68 / IP 69K	400	100	22	IGS254
	M18 / L = 45	12 nf	Brass	10...30	IP 65 / IP 66 / IP 67 / IP 68 / IP 69K	300	100	153	IGS255
	M30 / L = 60	15 f	Brass	10...30	IP 65 / IP 66 / IP 67 / IP 68 / IP 69K	100	100	154	IIS235
	M30 / L = 60	22 nf	Brass	10...30	IP 65 / IP 66 / IP 67 / IP 68 / IP 69K	100	100	155	IIS237
	M30 / L = 50	15 f	Brass	10...30	IP 65 / IP 66 / IP 67 / IP 68 / IP 69K	100	100	156	IIS248
	M30 / L = 50	22 nf	Brass	10...30	IP 65 / IP 66 / IP 67 / IP 68 / IP 69K	100	100	157	IIS249
M12 connector · Output function  · 3-wire · DC PNP · Wiring diagram no. 3 · Connector groups 8, 10, 19, 21, 23, 202									
	M12 / L = 60	4 f	Brass	10...30	IP 65 / IP 66 / IP 67 / IP 68 / IP 69K	700	100	1	IFS248
	M12 / L = 60	7 nf	Brass	10...30	IP 65 / IP 66 / IP 67 / IP 68 / IP 69K	700	100	2	IFS250
	M12 / L = 45	4 f	Brass	10...30	IP 65 / IP 66 / IP 67 / IP 68 / IP 69K	700	100	18	IFS260
	M12 / L = 45	7 nf	Brass	10...30	IP 65 / IP 66 / IP 67 / IP 68 / IP 69K	700	100	152	IFS261
	M18 / L = 60	8 f	Brass	10...30	IP 65 / IP 66 / IP 67 / IP 68 / IP 69K	400	100	3	IGS240
	M18 / L = 60	12 nf	Brass	10...30	IP 65 / IP 66 / IP 67 / IP 68 / IP 69K	300	100	4	IGS242
	M18 / L = 45	8 f	Brass	10...30	IP 65 / IP 66 / IP 67 / IP 68 / IP 69K	400	100	22	IGS252

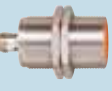























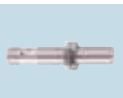





Position sensors

Type	Dimensions [mm]	Sensing range [mm]	Material	U _b [V]	Protection	f [Hz]	I _{load} [mA]	Drawing no.	Order no.
M12 connector · Output function  · 3-wire · DC PNP · Wiring diagram no. 3 · Connector groups 8, 10, 19, 21, 23, 202									
	M18 / L = 45	12 nf	Brass	10...30	IP 65 / IP 66 / IP 67 / IP 68 / IP 69K	300	100	153	IGS253
	M30 / L = 60	15 f	Brass	10...30	IP 65 / IP 66 / IP 67 / IP 68 / IP 69K	100	100	154	IIS234
	M30 / L = 60	22 nf	Brass	10...30	IP 65 / IP 66 / IP 67 / IP 68 / IP 69K	100	100	155	IIS236
	M30 / L = 50	15 f	Brass	10...30	IP 65 / IP 66 / IP 67 / IP 68 / IP 69K	100	100	156	IIS246
	M30 / L = 50	22 nf	Brass	10...30	IP 65 / IP 66 / IP 67 / IP 68 / IP 69K	100	100	157	IIS247

f = flush / nf = non flush / qf = quasi-flush

















Sensors for oils and coolants with increased sensing range















Type	Dimensions [mm]	Sensing range [mm]	Material	U _b [V]	Protection	f [Hz]	I _{load} [mA]	Drawing no.	Order no.
M12 connector · Output function  · 2-wire · DC PNP/NPN · Wiring diagram no. 24 · Connector groups 8, 10, 19, 21, 23									
	M12 / L = 45	4 f	Brass	10...30	IP 68	700	100	8	IFC202
M12 connector · Output function  · 2-wire · DC PNP/NPN · Wiring diagram no. 47 · Connector groups 8, 10, 19, 21, 23									
	M18 / L = 46	8 f	Brass	10...30	IP 68	300	100	10	IGC202
	M18 / L = 51	12 nf	Brass	10...30	IP 68	250	100	11	IGC203
M12 connector · Output function  · 2-wire · DC PNP/NPN · Wiring diagram no. 1 · Connector groups 8, 10, 19, 21, 23									
	M12 / L = 45	4 f	Brass	10...30	IP 68	700	100	8	IFC200
	M12 / L = 50	7 nf	Brass	10...30	IP 68	700	100	9	IFC201
M12 connector · Output function  · 2-wire · DC PNP/NPN · Wiring diagram no. 38 · Connector groups 8, 10, 19, 21, 23									
	M18 / L = 46	8 f	Brass	10...30	IP 68	400	100	10	IGC200

Type	Dimensions [mm]	Sensing range [mm]	Material	U _b [V]	Protection	f [Hz]	I _{load} [mA]	Draw- ing no.	Order no.
M12 connector · Output function  · 2-wire · DC PNP/NPN · Wiring diagram no. 38 · Connector groups 8, 10, 19, 21, 23									
	M18 / L = 51	12 nf	Brass	10...30	IP 68	250	100	11	IGC201
M12 connector · Output function  · 3-wire DC PNP · 2-wire DC PNP/NPN · Wiring diagram no. 39 · Connector groups 8, 10, 11, 18, 19, 21, 23									
	M12 / L = 70	4 f	Brass	10...30	IP 68	500	100	12	IFC210
	M18 / L = 70	8 f	Brass	10...30	IP 68	400	100	14	IGC210
M12 connector · Output function  · 3-wire · DC PNP · Wiring diagram no. 2 · Connector groups 8, 10, 19, 21, 23									
	M12 / L = 45	4 f	Brass	10...30	IP 68	700	100	18	IFC204
	M12 / L = 50	7 nf	Brass	10...30	IP 68	700	100	158	IFC205
M12 connector · Output function  · 3-wire · DC PNP · Wiring diagram no. 2 · Connector groups 8, 10, 11, 18, 19, 21, 23									
	M12 / L = 45	4 f	Brass	10...36	IP 68	700	100	8	IFC206
M12 connector · Output function  · 3-wire · DC PNP · Wiring diagram no. 2 · Connector groups 8, 10, 19, 21, 23									
	M12 / L = 60	4 f	Brass	10...30	IP 68	700	200	1	IFC229
	M12 / L = 60	7 nf	Brass	10...30	IP 68	700	200	2	IFC230
M12 connector · Output function  · 3-wire · DC PNP · Wiring diagram no. 2 · Connector groups 8, 10, 19, 21, 23, 25, 148, 149, 153, 184, 188, 193, 202									
	M12 / L = 70	4 f	Brass	10...30	IP 68	700	100	20	IFC237
	M12 / L = 70	7 nf	Brass	10...30	IP 68	700	100	21	IFC238
M12 connector · Output function  · 3-wire · DC PNP · Wiring diagram no. 2 · Connector groups 8, 10, 11, 18, 19, 21, 23									
	M18 / L = 46	8 f	Brass	10...36	IP 68	400	100	10	IGC204
	M18 / L = 51	12 nf	Brass	10...36	IP 68	300	100	11	IGC205



Position sensors

Type	Dimensions [mm]	Sensing range [mm]	Material	U _b [V]	Protection	f [Hz]	I _{load} [mA]	Draw- ing no.	Order no.
M12 connector · Output function  · 3-wire · DC PNP · Wiring diagram no. 2 · Connector groups 8, 10, 11, 18, 19, 21, 23									
	M18 / L = 46	8 f	Brass	10...36	IP 68	400	100	10	IGC206
	M18 / L = 60	12 nf	Brass	10...36	IP 68	300	200	125	IGC220
	M18 / L = 60	8 f	Brass	10...36	IP 68	400	200	126	IGC221
	M18 / L = 70	8 f	Brass	10...36	IP 68	400	100	14	IGC224
	M18 / L = 70	12 nf	Brass	10...36	IP 68	300	100	15	IGC225
	M30 / L = 50	15 f	Brass	10...36	IP 68	100	100	159	IIC200
	M30 / L = 50	22 nf	Brass	10...36	IP 68	100	100	160	IIC201
	M30 / L = 60	15 f	Brass	10...36	IP 68	100	200	161	IIC206
	M30 / L = 60	22 nf	Brass	10...36	IP 68	100	200	162	IIC207
	M30 / L = 70	15 f	High-grade st. steel	10...36	IP 68	100	100	16	IIC210
	M30 / L = 70	22 nf	High-grade st. steel	10...36	IP 68	100	100	17	IIC211
	M8 / L = 50	2 f	High-grade st. steel	10...36	IP 67	1000	200	65	IE5381
	M8 / L = 50	4 nf	High-grade st. steel	10...36	IP 67	700	200	163	IE5382
M12 connector · Output function  · 3-wire · DC PNP · Wiring diagram no. 3 · Connector groups 8, 10, 19, 21, 23									
	M12 / L = 50	7 nf	Brass	10...30	IP 68	700	100	158	IFC208

Type	Dimensions [mm]	Sensing range [mm]	Material	U _b [V]	Protection	f [Hz]	I _{load} [mA]	Draw- ing no.	Order no.
M12 connector · Output function  · 3-wire · DC PNP · Wiring diagram no. 3									
	M12 / L = 45	4 f	Brass	10...30	IP 68	700	100	18	IFC207
M12 connector · Output function  · 3-wire · DC PNP · Wiring diagram no. 3 · Connector groups 8, 10, 19, 21, 23									
	M12 / L = 45	4 f	Brass	10...36	IP 68	700	100	8	IFC209
	M18 / L = 46	8 f	Brass	10...36	IP 68	400	100	10	IGC207
	M18 / L = 51	12 nf	Brass	10...36	IP 68	300	100	11	IGC208
	M18 / L = 46	8 f	Brass	10...36	IP 68	400	100	10	IGC209
M12 connector · Output function  · 2-wire · DC PNP/NPN · Wiring diagram no. 40 · Connector groups 8, 10, 19, 21, 23									
	M12 / L = 60	4 f	Brass	10...36	IP 68	700	100	164	IFC234
	M12 / L = 60	7 nf	Brass	10...36	IP 68	500	100	165	IFC235
	M18 / L = 70	8 f	Brass	10...36	IP 68	400	100	14	IGC222
	M18 / L = 70	12 nf	Brass	10...36	IP 68	300	100	15	IGC223
	M30 / L = 70	15 f	Brass	10...30	IP 68	100	100	16	IIC208
	M30 / L = 70	22 nf	Brass	10...30	IP 68	100	100	17	IIC209

f = flush / nf = non flush / qf = quasi-flush



Position sensors

Sensors for oils and coolants, threaded housings

Type	Dimensions [mm]	Sensing range [mm]	Material	U _b [V]	Protection	f [Hz]	I _{load} [mA]	Drawing no.	Order no.
------	--------------------	-----------------------	----------	-----------------------	------------	-----------	---------------------------	-------------	-----------

Cable 0.8 m · with M12 connector · Output function  · 2-wire · DC PNP/NPN · Wiring diagram no. 1 · Connector groups 8, 10, 19, 21, 23



M8 / L = 42	2 f	Brass	10...55	IP 67	1000	100	166	IE9902
-------------	-----	-------	---------	-------	------	-----	-----	---------------

Cable 0.8 m · with M12 connector · Output function  · 2-wire · DC PNP/NPN · Wiring diagram no. 48 · Connector groups 8, 10, 19, 21, 23

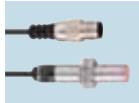

M12 / L = 54	2 f	Brass	10...55	IP 67	800	100	167	IF9920
--------------	-----	-------	---------	-------	-----	-----	-----	---------------

Cable 2 m · Output function  · 2-wire · DC PNP/NPN · Wiring diagram no. 25



M18 / L = 54	5 f	Brass	10...55	IP 67	700	400	168	IG5682
--------------	-----	-------	---------	-------	-----	-----	-----	---------------

Cable 2 m · Output function  · 2-wire · DC PNP/NPN · Wiring diagram no. 49

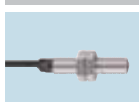

M8 / L = 42	2 f	Brass	10...55	IP 67	1000	100	169	IE9203
-------------	-----	-------	---------	-------	------	-----	-----	---------------



M12 / L = 54	2 f	Brass	10...55	IP 67	800	100	170	IF9222
--------------	-----	-------	---------	-------	-----	-----	-----	---------------

M12 connector · Output function  · 2-wire · DC PNP/NPN · Wiring diagram no. 1 · Connector groups 8, 10, 19, 21, 23



M12 / L = 60	2 f	Brass	10...55	IP 67	800	100	171	IF9924
--------------	-----	-------	---------	-------	-----	-----	-----	---------------

M12 connector · Output function  · 3-wire · DC PNP · Wiring diagram no. 2 · Connector groups 8, 10, 11, 18, 19, 21, 23



M12 / L = 45	2 f	Brass	10...36	IP 68	700	200	8	IFC239
--------------	-----	-------	---------	-------	-----	-----	---	---------------



M12 / L = 70	2 f	Brass	10...36	IP 68	700	200	12	IFC241
--------------	-----	-------	---------	-------	-----	-----	----	---------------



M12 / L = 60	2 f	Brass	10...36	IP 68	700	200	164	IFC243
--------------	-----	-------	---------	-------	-----	-----	-----	---------------

f = flush / nf = non flush / qf = quasi-flush

Sensors for oils and coolants, rectangular housings

Type	Dimensions [mm]	Sensing range [mm]	Material	U _b [V]	Protection	f [Hz]	I _{load} [mA]	Drawing no.	Order no.
------	--------------------	-----------------------	----------	-----------------------	------------	-----------	---------------------------	-------------	-----------

Cable 0.15 m · with M12 connector · Output function  · 2-wire · DC PNP/NPN · Wiring diagram no. 1 · Connector groups 8, 10, 19, 21, 23



26 x 26 x 26	10 f	polyamide	10...36	IP 67	250	100	172	IO5018
--------------	------	-----------	---------	-------	-----	-----	-----	---------------

Cable 0.8 m · with M12 connector · Output function  · 2-wire · DC PNP/NPN · Wiring diagram no. 1 · Connector groups 8, 10, 19, 21, 23



26 x 26 x 26	10 f	polyamide	10...36	IP 67	250	100	172	IO5017
--------------	------	-----------	---------	-------	-----	-----	-----	---------------

M12 connector · Output function  · 2-wire · DC PNP/NPN · Wiring diagram no. 1 · Connector groups 8, 10, 19, 21, 23



26 x 26 x 43	10 f	polyamide	10...36	IP 67	250	100	173	IO5016
--------------	------	-----------	---------	-------	-----	-----	-----	---------------

f = flush / nf = non flush / qf = quasi-flush

Sensors for oils and coolants with correction factor 1

Type	Dimensions [mm]	Sensing range [mm]	Material	U _b [V]	Protection	f [Hz]	I _{load} [mA]	Drawing no.	Order no.
------	--------------------	-----------------------	----------	-----------------------	------------	-----------	---------------------------	-------------	-----------

M12 connector · Output function  · 3-wire · DC PNP · Wiring diagram no. 2



M12 / L = 65	8 nf	High-grade st. steel	10...30	IP 68	2000	100	175	IFC246
--------------	------	----------------------	---------	-------	------	-----	-----	---------------

M12 connector · Output function  · 3-wire · DC PNP · Wiring diagram no. 2 · Connector groups 8, 10, 19, 21, 23



M18 / L = 65	5 f	High-grade st. steel	10...30	IP 68	2000	100	176	IGC232
--------------	-----	----------------------	---------	-------	------	-----	-----	---------------

M12 connector · Output function  · 3-wire · DC PNP · Wiring diagram no. 2 · Connector groups 8, 10, 11, 18, 19, 21, 23



M18 / L = 65	12 nf	High-grade st. steel	10...30	IP 68	2000	200	177	IGC233
--------------	-------	----------------------	---------	-------	------	-----	-----	---------------

M12 connector · Output function  · 3-wire · DC PNP · Wiring diagram no. 2 · Connector group --

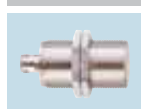

M30 / L = 65	10 f	High-grade st. steel	10...30	IP 68	2000	100	178	IIC218
--------------	------	----------------------	---------	-------	------	-----	-----	---------------

M12 connector · Output function  · 3-wire · DC PNP · Wiring diagram no. 2 · Connector groups 8, 10, 11, 18, 19, 21, 23



M30 / L = 65	22 nf	High-grade st. steel	10...30	IP 68	1000	200	179	IIC219
--------------	-------	----------------------	---------	-------	------	-----	-----	---------------



Position sensors

Type	Dimensions [mm]	Sensing range [mm]	Material	U _b [V]	Protection	f [Hz]	I _{load} [mA]	Drawing no.	Order no.
------	--------------------	-----------------------	----------	-----------------------	------------	-----------	---------------------------	-------------	-----------

M12 connector · Output function · 3-wire · DC PNP · Wiring diagram no. 2

	M12 / L = 65	3 f	stainless steel (316L)	10...30	IP 68	2000	100	180	IFC259
---	--------------	-----	------------------------	---------	-------	------	-----	-----	---------------

M8 connector · Output function · 3-wire · DC PNP · Wiring diagram no. 2 · Connector groups 1, 2, 3

	M8 / L = 65	1.5 f	High-grade st. steel	10...30	IP 67	1000	200	181	IE5390
---	-------------	-------	----------------------	---------	-------	------	-----	-----	---------------

	M8 / L = 65	4 nf	High-grade st. steel	10...30	IP 67	1000	200	182	IE5391
---	-------------	------	----------------------	---------	-------	------	-----	-----	---------------

f = flush / nf = non flush / qf = quasi-flush

Sensors for oils and coolants with ceramic sensing face

Type	Dimensions [mm]	Sensing range [mm]	Material	U _b [V]	Protection	f [Hz]	I _{load} [mA]	Drawing no.	Order no.
------	--------------------	-----------------------	----------	-----------------------	------------	-----------	---------------------------	-------------	-----------

M12 connector · Output function · 3-wire DC PNP · 2-wire DC PNP/NPN · Wiring diagram no. 39 · Connector groups 8, 10, 11, 18, 19, 21, 23

	M12 / L = 70	4 f	Brass	10...30	IP 68	500	100	12	IFC210
---	--------------	-----	-------	---------	-------	-----	-----	----	---------------

	M18 / L = 70	8 f	Brass	10...30	IP 68	400	100	14	IGC210
---	--------------	-----	-------	---------	-------	-----	-----	----	---------------

M12 connector · Output function · 3-wire · DC PNP · Wiring diagram no. 2 · Connector groups 8, 10, 11, 18, 19, 21, 23

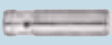
	M12 / L = 45	4 f	Brass	10...36	IP 68	700	100	8	IFC206
---	--------------	-----	-------	---------	-------	-----	-----	---	---------------

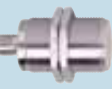
	M30 / L = 60	15 f	Brass	10...36	IP 68	100	200	161	IIC206
---	--------------	------	-------	---------	-------	-----	-----	-----	---------------





M12 connector · Output function · 3-wire · DC PNP · Wiring diagram no. 3 · Connector groups 8, 10, 19, 21, 23

	M12 / L = 45	4 f	Brass	10...36	IP 68	700	100	8	IFC209
---	--------------	-----	-------	---------	-------	-----	-----	---	---------------

	M18 / L = 46	8 f	Brass	10...36	IP 68	400	100	10	IGC209
---	--------------	-----	-------	---------	-------	-----	-----	----	---------------









f = flush / nf = non flush / qf = quasi-flush

Sensors for oils and coolants, AS-i system

Type	Dimensions [mm]	Sensing range [mm]	Material	U _b [V]	Protection	f [Hz]	I _{load} [mA]	Drawing no.	Order no.
M12 connector · 2-wire · AS-i · Wiring diagram no. 10 · Connector groups 8, 10, 19, 21, 23									
	M12 / L = 60	4 f	High-grade st. steel	26.5...31.6	IP 68	100	–	164	IFC247
	M18 / L = 60	8 f	High-grade st. steel	26.5...31.6	IP 68	100	–	126	IGC234
	M18 / L = 60	12 nf	High-grade st. steel	26.5...31.6	IP 68	100	–	125	IGC235
	M30 / L = 60	14 f	High-grade st. steel	26.5...31.6	IP 68	100	–	161	IIC220
	M30 / L = 60	22 nf	High-grade st. steel	26.5...31.6	IP 68	100	–	162	IIC221

f = flush / nf = non flush / qf = quasi-flush

Electromagnetic field immune Kplus sensors with correction factor 1

Type	Dimensions [mm]	Sensing range [mm]	Material	U _b [V]	Protection	f [Hz]	I _{load} [mA]	Drawing no.	Order no.
M8 connector · Output function  · 3-wire · DC PNP · Wiring diagram no. 2 · Connector groups 145, 146									
	M8 / L = 40	3 f	High-grade st. steel	10...30	IP 65 / IP 66 / IP 67 / IP 68 / IP 69K	2000	100	183	IES200
	M8 / L = 40	6 nf	High-grade st. steel	10...30	IP 65 / IP 66 / IP 67 / IP 68 / IP 69K	2000	100	184	IES201
M8 connector · Output function  · 3-wire · DC PNP · Wiring diagram no. 2									
	M8 / L = 40	3 f	High-grade st. steel	10...30	IP 65 / IP 66 / IP 67 / IP 68 / IP 69K	2000	100	183	IEW200
	M8 / L = 40	6 nf	High-grade st. steel	10...30	IP 65 / IP 66 / IP 67 / IP 68 / IP 69K	2000	100	184	IEW201
M12 connector · Output function  · 3-wire · DC PNP · Wiring diagram no. 2 · Connector groups 8, 10, 19, 21, 23, 202									
	M12 / L = 45	4 f	Brass	10...30	IP 65 / IP 66 / IP 67 / IP 68 / IP 69K	2000	100	18	IFS289
	M12 / L = 45	10 nf	Brass	10...30	IP 65 / IP 66 / IP 67 / IP 68 / IP 69K	2000	100	185	IFS290

You can find wiring diagrams and scale drawings from page 134









Position sensors

Type	Dimensions [mm]	Sensing range [mm]	Material	U _b [V]	Protection	f [Hz]	I _{load} [mA]	Draw- ing no.	Order no.
M12 connector · Output function  · 3-wire · DC PNP · Wiring diagram no. 2 · Connector groups 8, 10, 19, 21, 23, 202									
	M12 / L = 60	4 f	Brass	10...30	IP 65 / IP 66 / IP 67 / IP 68 / IP 69K	2000	100	1	IFS285
	M12 / L = 60	10 nf	Brass	10...30	IP 65 / IP 66 / IP 67 / IP 68 / IP 69K	2000	100	186	IFS286
	M18 / L = 45	8 f	Brass	10...30	IP 65 / IP 66 / IP 67 / IP 68 / IP 69K	2000	100	22	IGS279
	M18 / L = 45	15 nf	Brass	10...30	IP 65 / IP 66 / IP 67 / IP 68 / IP 69K	2000	100	187	IGS280
	M18 / L = 60	8 f	Brass	10...30	IP 65 / IP 66 / IP 67 / IP 68 / IP 69K	2000	100	3	IGS277
	M18 / L = 60	15 nf	Brass	10...30	IP 65 / IP 66 / IP 67 / IP 68 / IP 69K	2000	100	188	IGS278
	M30 / L = 45	15 f	Brass	10...30	IP 65 / IP 66 / IP 67 / IP 68 / IP 69K	2000	100	189	IIS269
	M30 / L = 60	15 f	Brass	10...30	IP 65 / IP 66 / IP 67 / IP 68 / IP 69K	2000	100	154	IIS267
	M30 / L = 60	30 nf	Brass	10...30	IP 65 / IP 66 / IP 67 / IP 68 / IP 69K	2000	100	190	IIS268
M12 connector · Output function  · 3-wire · DC PNP · Wiring diagram no. 2 · Connector groups 8, 10, 19, 21, 23, 148, 153, 184, 188, 193									
	M12 / L = 45	4 f	High-grade st. steel	10...30	IP 65 / IP 66 / IP 67 / IP 68 / IP 69K	2000	100	18	IFS297
	M12 / L = 45	8 nf	High-grade st. steel	10...30	IP 65 / IP 66 / IP 67 / IP 68 / IP 69K	2000	100	185	IFS298
	M12 / L = 45	10 nf	High-grade st. steel	10...30	IP 65 / IP 66 / IP 67 / IP 68 / IP 69K	2000	100	185	IFS299
	M12 / L = 60	4 f	High-grade st. steel	10...30	IP 65 / IP 66 / IP 67 / IP 68 / IP 69K	2000	100	1	IFS304
	M12 / L = 60	8 nf	High-grade st. steel	10...30	IP 65 / IP 66 / IP 67 / IP 68 / IP 69K	2000	100	186	IFS305
	M12 / L = 60	10 nf	High-grade st. steel	10...30	IP 65 / IP 66 / IP 67 / IP 68 / IP 69K	2000	100	186	IFS306

Type	Dimensions [mm]	Sensing range [mm]	Material	U _b [V]	Protection	f [Hz]	I _{load} [mA]	Draw- ing no.	Order no.
M12 connector · Output function  · 3-wire · DC PNP · Wiring diagram no. 2 · Connector groups 8, 10, 19, 21, 23, 148, 153, 184, 188, 193									
	M18 / L = 45	8 f	High-grade st. steel	10...30	IP 65 / IP 66 / IP 67 / IP 68 / IP 69K	2000	100	22	IGS287
	M18 / L = 45	12 nf	High-grade st. steel	10...30	IP 65 / IP 66 / IP 67 / IP 68 / IP 69K	2000	100	187	IGS288
	M18 / L = 45	15 nf	High-grade st. steel	10...30	IP 65 / IP 66 / IP 67 / IP 68 / IP 69K	2000	100	187	IGS289
	M18 / L = 60	8 f	High-grade st. steel	10...30	IP 65 / IP 66 / IP 67 / IP 68 / IP 69K	2000	100	3	IGS290
	M18 / L = 60	12 nf	High-grade st. steel	10...30	IP 65 / IP 66 / IP 67 / IP 68 / IP 69K	2000	100	188	IGS291
	M18 / L = 60	15 nf	High-grade st. steel	10...30	IP 65 / IP 66 / IP 67 / IP 68 / IP 69K	2000	100	188	IGS292
	M30 / L = 45	15 f	High-grade st. steel	10...30	IP 65 / IP 66 / IP 67 / IP 68 / IP 69K	2000	100	189	IIS281
	M30 / L = 60	15 f	High-grade st. steel	10...30	IP 65 / IP 66 / IP 67 / IP 68 / IP 69K	2000	100	154	IIS282
	M30 / L = 60	22 nf	High-grade st. steel	10...30	IP 65 / IP 66 / IP 67 / IP 68 / IP 69K	2000	100	190	IIS283
	M30 / L = 60	30 nf	High-grade st. steel	10...30	IP 65 / IP 66 / IP 67 / IP 68 / IP 69K	2000	100	190	IIS284
M12 connector · Output function  · 3-wire · DC PNP · Wiring diagram no. 2 · Connector groups 137, 140, 141									
	M12 / L = 65	3 f	Brass	10...30	IP 67	2000	100	180	IFW200
	M12 / L = 65	8 nf	Brass	10...30	IP 67	2000	100	191	IFW201
	M18 / L = 65	5 f	Brass	10...30	IP 67	2000	100	176	IGW200
M12 connector · Output function  · 3-wire · DC PNP · Wiring diagram no. 2 · Connector groups 137, 138, 139, 140, 141									
	M18 / L = 65	12 nf	Brass	10...30	IP 67	2000	200	177	IGW201



Position sensors

Type	Dimensions [mm]	Sensing range [mm]	Material	U _b [V]	Protection	f [Hz]	I _{load} [mA]	Draw- ing no.	Order no.
M12 connector · Output function  · 3-wire · DC PNP · Wiring diagram no. 2 · Connector groups 137, 140, 141									
	M30 / L = 65	10 f	Brass	10...30	IP 67	2000	100	178	IIW200
	M30 / L = 65	22 nf	Brass	10...30	IP 67	2000	100	192	IIW201
	M12 / L = 65	4 f	Brass	10...30	IP 65 / IP 66 / IP 67 / IP 68 / IP 69K	2000	100	180	IFW204
	M18 / L = 65	8 f	Brass	10...30	IP 65 / IP 66 / IP 67 / IP 68 / IP 69K	2000	100	176	IGW202
	M30 / L = 65	15 f	Brass	10...30	IP 65 / IP 66 / IP 67 / IP 68 / IP 69K	2000	100	178	IIW202
M12 connector · Output function  · 3-wire · DC PNP · Wiring diagram no. 2 · Connector groups 137, 138, 139, 140, 141									
	40 x 40 x 54	20 f	PA (polyamide)	10...36	IP 67	200	200	109	IM5119
	40 x 40 x 54	35 nf	PA (polyamide)	10...36	IP 67	200	200	109	IM5120
	40 x 40 x 54	40 nf	PA (polyamide)	10...36	IP 67	200	200	109	IM5129
M12 connector · Output function  · 4-wire · DC PNP · Wiring diagram no. 11 · Connector groups 137, 138, 139, 140, 141									
	40 x 40 x 54	20 f	PA (polyamide)	10...36	IP 67	200	200	109	IM5124
	40 x 40 x 54	35 nf	PA (polyamide)	10...36	IP 67	200	200	109	IM5125
	40 x 40 x 54	40 nf	PA (polyamide)	10...36	IP 67	200	200	109	IM5126
	40 x 40 x 54	20 f	PA (polyamide)	10...36	IP 67	200	200	7	IM5132
M12 connector · Output function  · 4-wire · DC PNP · Wiring diagram no. 11 · Connector groups 8, 9, 10, 11, 18, 19, 21, 23, 25, 148, 149, 150, 151, 153, 154, 184, 188, 190, 193, 202, 203, 204									
	40 x 40 x 54	35 nf	PA (polyamide)	10...36	IP 67	200	200	7	IM5133

Type	Dimensions [mm]	Sensing range [mm]	Material	U _b [V]	Protection	f [Hz]	I _{load} [mA]	Draw- ing no.	Order no.
------	--------------------	--------------------------	----------	-----------------------	------------	-----------	---------------------------	---------------------	--------------

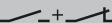
M12 connector · Output function  · 4-wire · DC PNP · Wiring diagram no. 11 · Connector groups 8, 9, 10, 11, 18, 19, 21, 23, 25, 148, 149, 150, 151, 153, 154, 184, 188, 190, 193, 202, 203, 204







	40 x 40 x 54	40 nf	PA (polyamide)	10...36	IP 67 / IP 69K	200	200	7	IM5135
---	--------------	-------	----------------	---------	----------------	-----	-----	---	--------

f = flush / nf = non flush / qf = quasi-flush

Electromagnetic field immune sensors

Type	Dimensions [mm]	Sensing range [mm]	Material	U _b [V]	Protection	f [Hz]	I _{load} [mA]	Draw- ing no.	Order no.
------	--------------------	--------------------------	----------	-----------------------	------------	-----------	---------------------------	---------------------	--------------

M12 connector · Output function  · 3-wire · DC PNP · Wiring diagram no. 2 · Connector groups 137, 138, 139, 140, 141

	M12 / L = 60	4 nf	Brass	10...36	IP 67	1000	250	193	IF5675
	M18 / L = 60	5 f	Brass	10...36	IP 67	700	250	126	IG5647
	M12 / L = 60	2 f	Brass	10...36	IP 67	1000	250	194	IF5670
	M12 / L = 60	2 f	Brass	10...36	IP 67	1000	250	194	IF5750
	M12 / L = 60	4 nf	Brass	10...36	IP 67	1000	250	193	IF5751
	M18 / L = 60	5 f	Brass	10...36	IP 67	700	250	126	IG5667
	M30 / L = 60	10 f	Brass	10...36	IP 67	250	250	195	II5503

M12 connector · Output function  · 4-wire · DC PNP · Wiring diagram no. 11 · Connector groups 137, 138, 139, 140, 141

	92 x 80 x 40	50 f	PPE	10...36	IP 67	70	250	108	ID5059
---	--------------	------	-----	---------	-------	----	-----	-----	--------

f = flush / nf = non flush / qf = quasi-flush





Position sensors

Full metal sensors for oils and coolants

Type	Dimensions [mm]	Sensing range [mm]	Material	U _b [V]	Protection	f [Hz]	I _{load} [mA]	Draw- ing no.	Order no.
------	--------------------	--------------------------	----------	-----------------------	------------	-----------	---------------------------	---------------------	--------------

M12 connector · Output function · 3-wire · DC PNP · Wiring diagram no. 2 · Connector groups 8, 10, 19, 21, 23

	M12 / L = 45	4 f	High-grade st. steel	10...30	IP 65 / IP 66 / IP 67 / IP 68 / IP 69K	100	100	18	IFC275
	M18 / L = 45	8 f	High-grade st. steel	10...30	IP 65 / IP 66 / IP 67 / IP 68 / IP 69K	100	100	22	IGC258
	M30 / L = 50	15 f	High-grade st. steel	10...30	IP 65 / IP 66 / IP 67 / IP 68 / IP 69K	50	100	156	IIC233

M12 connector · Output function · 3-wire · DC NPN · Wiring diagram no. 22 · Connector groups 8, 10, 19, 21, 23

	M8 / L = 60	2 f	High-grade st. steel	10...36	IP 67 / IP 68	100	100	196	IEC203
	M12 / L = 60	3 f	High-grade st. steel	10...36	IP 67 / IP 68	100	100	164	IFC266
	M18 / L = 70	5 f	High-grade st. steel	10...36	IP 67 / IP 68	100	100	70	IGC252
	M30 / L = 70	10 f	High-grade st. steel	10...36	IP 67 / IP 68	50	100	197	IIC226

M12 connector · Output function · 3-wire · DC PNP · Wiring diagram no. 2 · Connector groups 8, 10, 11, 18, 19, 21, 23

	M8 / L = 60	2 f	High-grade st. steel	10...36	IP 67 / IP 68 / IP 69K	100	100	196	IEC200
	M12 / L = 60	3 f	High-grade st. steel	10...36	IP 67 / IP 68	100	100	164	IFC258
	M18 / L = 70	5 f	High-grade st. steel	10...36	IP 67 / IP 68	100	100	70	IGC248
	M30 / L = 70	10 f	High-grade st. steel	10...36	IP 67 / IP 68	50	100	197	IIC224

M8 connector · Output function · 3-wire · DC NPN · Wiring diagram no. 22 · Connector groups 1, 3

	M8 / L = 50	2 f	High-grade st. steel	10...36	IP 67	100	100	198	IEC202
---	-------------	-----	----------------------	---------	-------	-----	-----	-----	---------------

Type	Dimensions [mm]	Sensing range [mm]	Material	U _b [V]	Protection	f [Hz]	I _{load} [mA]	Drawing no.	Order no.
------	--------------------	-----------------------	----------	-----------------------	------------	-----------	---------------------------	-------------	-----------

M8 connector · Output function  · 3-wire · DC PNP · Wiring diagram no. 2 · Connector groups 1, 2, 3



M8 / L = 50	2 f	High-grade st. steel	10...36	IP 67	100	100	198	IEC201
-------------	-----	----------------------	---------	-------	-----	-----	-----	--------

f = flush / nf = non flush / qf = quasi-flush

Full metal sensors for oils and coolants with correction factor 0

Type	Dimensions [mm]	Sensing range [mm]	Material	U _b [V]	Protection	f [Hz]	I _{load} [mA]	Drawing no.	Order no.
------	--------------------	-----------------------	----------	-----------------------	------------	-----------	---------------------------	-------------	-----------

M12 connector · Output function  · 3-wire · DC PNP · Wiring diagram no. 2 · Connector groups 8, 10, 11, 18, 19, 21, 23



M12 / L = 60	2.5 f	High-grade st. steel	10...36	IP 68	100	100	164	IFC263
--------------	-------	----------------------	---------	-------	-----	-----	-----	--------



M18 / L = 70	4.5 f	High-grade st. steel	10...36	IP 68	100	100	199	IGC249
--------------	-------	----------------------	---------	-------	-----	-----	-----	--------

M12 connector · Output function  · 3-wire · DC PNP · Wiring diagram no. 3 · Connector groups 8, 10, 19, 21, 23



M12 / L = 60	2.5 f	High-grade st. steel	10...36	IP 68	100	100	164	IFC264
--------------	-------	----------------------	---------	-------	-----	-----	-----	--------



M18 / L = 70	4.5 f	High-grade st. steel	10...36	IP 68	100	100	199	IGC250
--------------	-------	----------------------	---------	-------	-----	-----	-----	--------

f = flush / nf = non flush / qf = quasi-flush

Full metal sensors with non-stick coating against weld spatter

Type	Dimensions [mm]	Sensing range [mm]	Material	U _b [V]	Protection	f [Hz]	I _{load} [mA]	Drawing no.	Order no.
------	--------------------	-----------------------	----------	-----------------------	------------	-----------	---------------------------	-------------	-----------

Cable 0.3 m · with M12 connector · Output function  · 2-wire · DC PNP/NPN · Wiring diagram no. 1 · Connector groups 137, 140, 141

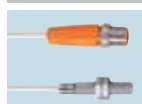

M8 / L = 45	2 f	High-grade st. steel	10...36	IP 67	150	100	200	IER203
-------------	-----	----------------------	---------	-------	-----	-----	-----	--------

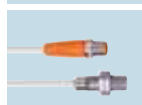

M12 / L = 40	4 f	High-grade st. steel	10...36	IP 67	75	100	201	IFR203
--------------	-----	----------------------	---------	-------	----	-----	-----	--------



M18 / L = 40	6 f	High-grade st. steel	10...36	IP 67	50	100	202	IGR203
--------------	-----	----------------------	---------	-------	----	-----	-----	--------











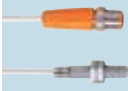



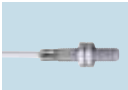
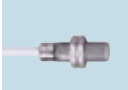

M30 / L = 40	12 f	High-grade st. steel	10...36	IP 67	25	100	203	IIR203
--------------	------	----------------------	---------	-------	----	-----	-----	--------

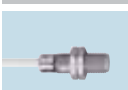
You can find wiring diagrams and scale drawings from page 134





Position sensors



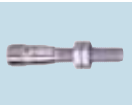

Type	Dimensions [mm]	Sensing range [mm]	Material	U _b [V]	Protection	f [Hz]	I _{load} [mA]	Draw- ing no.	Order no.
Cable 0.3 m · with M12 connector · Output function  · 2-wire · DC PNP/NPN · Wiring diagram no. 26 · Connector groups 137, 140, 141									
	M8 / L = 45	2 f	High-grade st. steel	10...36	IP 67	150	100	200	IER206
	M12 / L = 40	4 f	High-grade st. steel	10...36	IP 67	75	100	201	IFR206
	M18 / L = 40	6 f	High-grade st. steel	10...36	IP 67	50	100	202	IGR206
	M30 / L = 40	12 f	High-grade st. steel	10...36	IP 67	25	100	203	IIR206
Cable 3 m · Output function  · 2-wire · DC PNP/NPN · Wiring diagram no. 27									
	M8 / L = 45	2 f	High-grade st. steel	10...36	IP 67	150	100	204	IER204
	M12 / L = 40	4 f	High-grade st. steel	10...36	IP 67	75	100	205	IFR204
	M18 / L = 40	6 f	High-grade st. steel	10...36	IP 67	50	100	206	IGR204
	M30 / L = 40	12 f	High-grade st. steel	10...36	IP 67	25	100	207	IIR204
Cable 5 m · Output function  · 2-wire · DC PNP/NPN · Wiring diagram no. 27									
	M12 / L = 40	4 f	High-grade st. steel	10...36	IP 67	75	100	205	IFR205
	M18 / L = 40	6 f	High-grade st. steel	10...36	IP 67	50	100	206	IGR205
	M30 / L = 40	12 f	High-grade st. steel	10...36	IP 67	25	100	207	IIR205
M12 connector · Output function  · 3-wire · DC PNP · Wiring diagram no. 2 · Connector groups 137, 140, 141									
	M12 / L = 45	4 f	High-grade st. steel	10...30	IP 65 / IP 66 / IP 67 / IP 68 / IP 69K	2	100	18	IFR207
	M18 / L = 45	8 f	High-grade st. steel	10...30	IP 65 / IP 66 / IP 67 / IP 68 / IP 69K	2	100	22	IGR207
	M30 / L = 50	15 f	High-grade st. steel	10...30	IP 65 / IP 66 / IP 67 / IP 68 / IP 69K	2	100	156	IIR207

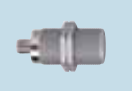
Type	Dimensions [mm]	Sensing range [mm]	Material	U _b [V]	Protection	f [Hz]	I _{load} [mA]	Draw- ing no.	Order no.
------	--------------------	--------------------------	----------	-----------------------	------------	-----------	---------------------------	---------------------	--------------

M12 connector · Output function  · 3-wire · DC NPN · Wiring diagram no. 22 · Connector groups 137, 140, 141

	M8 / L = 60	2 f	High-grade st. steel	10...36	IP 67 / IP 68	100	100	196	IER201
	M12 / L = 60	4 f	High-grade st. steel	10...36	IP 67	2	100	164	IFR202
	M18 / L = 70	6 f	High-grade st. steel	10...36	IP 67	2	100	70	IGR202
	M30 / L = 70	12 f	High-grade st. steel	10...36	IP 67	2	100	197	IIR202

M12 connector · Output function  · 3-wire · DC PNP · Wiring diagram no. 2 · Connector groups 137, 138, 139, 140, 141

	M8 / L = 60	2 f	High-grade st. steel	10...36	IP 67 / IP 68	100	100	196	IER200
	M12 / L = 60	4 f	High-grade st. steel	10...36	IP 67	2	100	164	IFR200
	M18 / L = 70	6 f	High-grade st. steel	10...36	IP 67	2	100	70	IGR200
	M30 / L = 70	12 f	High-grade st. steel	10...36	IP 67	2	100	197	IIR200

f = flush / nf = non flush / qf = quasi-flush

Full metal sensors for hygienic and wet areas





Type	Dimensions [mm]	Sensing range [mm]	Material	U _b [V]	Protection	f [Hz]	I _{load} [mA]	Draw- ing no.	Order no.
------	--------------------	--------------------------	----------	-----------------------	------------	-----------	---------------------------	---------------------	--------------

M12 connector · Output function  · 3-wire · DC PNP · Wiring diagram no. 2 · Connector groups 148, 153, 184, 188, 193

	M12 / L = 45	4 f	High-grade st. steel	10...30	IP 65 / IP 66 / IP 67 / IP 68 / IP 69K	100	100	18	IFT257
	M18 / L = 45	8 f	High-grade st. steel	10...30	IP 65 / IP 66 / IP 67 / IP 68 / IP 69K	100	100	22	IGT258
	M30 / L = 50	15 f	High-grade st. steel	10...30	IP 65 / IP 66 / IP 67 / IP 68 / IP 69K	50	100	156	IIT243



Position sensors

Type	Dimensions [mm]	Sensing range [mm]	Material	U _b [V]	Protection	f [Hz]	I _{load} [mA]	Drawing no.	Order no.
M12 connector · Output function  · 3-wire · DC NPN · Wiring diagram no. 22 · Connector groups 148, 152, 153, 155, 184, 186, 188, 192, 193									
	M12 / L = 70	6 nf	High-grade st. steel	10...36	IP 65 / IP 67 / IP 68 / IP 69K	500	100	208	IFT246
	M18 / L = 70	12 nf	High-grade st. steel	10...36	IP 65 / IP 67 / IP 68 / IP 69K	500	100	209	IGT250
	M30 / L = 70	25 nf	High-grade st. steel	10...36	IP 65 / IP 67 / IP 68 / IP 69K	250	100	210	IIT232
M12 connector · Output function  · 3-wire · DC NPN · Wiring diagram no. 22 · Connector groups 148, 153, 184, 188, 193									
	M18 / L = 70	5 f	High-grade st. steel	10...36	IP 68 / IP 69K	100	100	70	IGT248
	M12 / L = 60	3 f	High-grade st. steel	10...36	IP 68 / IP 69K	100	100	164	IFT244
	M30 / L = 70	10 f	High-grade st. steel	10...36	IP 68 / IP 69K	50	100	197	IIT230
M12 connector · Output function  · 3-wire · DC PNP · Wiring diagram no. 2 · Connector groups 148, 150, 152, 153, 154, 155, 184, 186, 188, 190, 192, 193									
	M12 / L = 70	6 nf	High-grade st. steel	10...36	IP 65 / IP 67 / IP 68 / IP 69K	500	100	208	IFT245
	M18 / L = 70	12 nf	High-grade st. steel	10...36	IP 65 / IP 67 / IP 68 / IP 69K	500	100	209	IGT249
	M30 / L = 70	25 nf	High-grade st. steel	10...36	IP 65 / IP 67 / IP 68 / IP 69K	250	100	210	IIT231
M12 connector · Output function  · 3-wire · DC PNP · Wiring diagram no. 2 · Connector groups 148, 150, 153, 154, 184, 188, 190, 193									
	M18 / L = 70	5 f	High-grade st. steel	10...36	IP 68 / IP 69K	100	100	70	IGT247
	M30 / L = 70	10 f	High-grade st. steel	10...36	IP 68 / IP 69K	50	100	197	IIT228
	M12 / L = 60	3 f	High-grade st. steel	10...36	IP 68 / IP 69K	100	100	164	IFT240
	Ø 12 / L = 60	3 f	High-grade st. steel	10...36	IP 68 / IP 69K	100	100	211	IFT243

f = flush / nf = non flush / qf = quasi-flush







Sensors for hygienic and wet areas with increased sensing range

Type	Dimensions [mm]	Sensing range [mm]	Material	U _b [V]	Protection	f [Hz]	I _{load} [mA]	Draw- ing no.	Order no.
------	--------------------	--------------------------	----------	-----------------------	------------	-----------	---------------------------	---------------------	--------------







1/2" UNF-Connector · Output function  · 2-wire · AC/DC · Wiring diagram no. 28 · Connector group 33

	M30 / L = 70	22 nf	High-grade st. steel	20...140	IP 68 / IP 69K	25 / 100	80	212	IIT002
---	--------------	-------	----------------------	----------	----------------	----------	----	-----	--------

Cable 10 m · Output function  · 3-wire · DC PNP · Wiring diagram no. 5

	M12 / L = 50	4 f	High-grade st. steel	10...36	IP 68 / IP 69K	800	100	213	IFT207
	M12 / L = 61	7 nf	High-grade st. steel	10...36	IP 68 / IP 69K	800	100	214	IFT209
	M18 / L = 57	8 f	High-grade st. steel	10...36	IP 68 / IP 69K	600	100	215	IGT207
	M18 / L = 62	12 nf	High-grade st. steel	10...36	IP 68 / IP 69K	300	100	216	IGT209
	M30 / L = 59	14 f	High-grade st. steel	10...36	IP 68 / IP 69K	100	100	217	IIT206
	M30 / L = 59	22 nf	High-grade st. steel	10...36	IP 68 / IP 69K	100	100	218	IIT208

Cable 6 m · Output function  · 3-wire · DC PNP · Wiring diagram no. 5

	M12 / L = 50	4 f	High-grade st. steel	10...36	IP 68 / IP 69K	800	100	213	IFT206
	M12 / L = 61	7 nf	High-grade st. steel	10...36	IP 68 / IP 69K	800	100	214	IFT208
	M18 / L = 57	8 f	High-grade st. steel	10...36	IP 68 / IP 69K	600	100	215	IGT206
	M18 / L = 62	12 nf	High-grade st. steel	10...36	IP 68 / IP 69K	300	100	216	IGT208
	M30 / L = 59	22 nf	High-grade st. steel	10...36	IP 68 / IP 69K	100	100	218	IIT207
	M30 / L = 59	14 f	High-grade st. steel	10...36	IP 68 / IP 69K	100	100	217	IIT209







Position sensors





Type	Dimensions [mm]	Sensing range [mm]	Material	U _b [V]	Protection	f [Hz]	I _{load} [mA]	Draw- ing no.	Order no.
M12 connector · Output function  · 3-wire DC PNP · 2-wire DC PNP/NPN · Wiring diagram no. 39 · Connector groups 148, 150, 153, 154, 184, 188, 190, 193									
	M12 / L = 70	7 nf	High-grade st. steel	10...30	IP 68 / IP 69K	700	100	219	IFT202
	M12 / L = 70	4 f	High-grade st. steel	10...36	IP 68 / IP 69K	500	100	12	IFT205
	Ø 12 / L = 70	7 nf	High-grade st. steel	10...30	IP 68 / IP 69K	700	100	220	IFT210
	M18 / L = 70	12 nf	High-grade st. steel	10...30	IP 68 / IP 69K	300	100	221	IGT202
	M18 / L = 70	8 f	High-grade st. steel	10...36	IP 68 / IP 69K	400	100	14	IGT205
	M30 / L = 70	22 nf	High-grade st. steel	10...36	IP 68 / IP 69K	100	100	17	IIT202
	M30 / L = 70	14 f	High-grade st. steel	10...36	IP 68 / IP 69K	100	100	16	IIT204
M12 connector · Output function  · 3-wire · DC PNP · Wiring diagram no. 2 · Connector groups 148, 150, 153, 154, 184, 188, 190, 193									
	M12 / L = 50	7 nf	High-grade st. steel	10...36	IP 68 / IP 69K	800	100	222	IFT200
	M12 / L = 45	4 f	High-grade st. steel	10...36	IP 68 / IP 69K	800	100	8	IFT203
	M12 / L = 70	4 f	High-grade st. steel	10...36	IP 68 / IP 69K	700	100	12	IFT216
	M12 / L = 70	7 nf	High-grade st. steel	10...36	IP 68 / IP 69K	800	100	13	IFT217
	M18 / L = 51	12 nf	High-grade st. steel	10...36	IP 68 / IP 69K	300	100	223	IGT200
	M18 / L = 46	8 f	High-grade st. steel	10...36	IP 68 / IP 69K	600	100	10	IGT203
	M18 / L = 70	8 f	High-grade st. steel	10...36	IP 68 / IP 69K	400	100	14	IGT219
	M18 / L = 70	12 nf	High-grade st. steel	10...36	IP 68 / IP 69K	300	100	15	IGT220

Type	Dimensions [mm]	Sensing range [mm]	Material	U _b [V]	Protection	f [Hz]	I _{load} [mA]	Draw- ing no.	Order no.
------	--------------------	--------------------------	----------	-----------------------	------------	-----------	---------------------------	---------------------	--------------

M12 connector · Output function  · 3-wire · DC PNP · Wiring diagram no. 2 · Connector groups 148, 150, 153, 154, 184, 188, 190, 193

	M30 / L = 50	22 nf	High-grade st. steel	10...36	IP 68 / IP 69K	100	100	224	IIT200
	M30 / L = 50	14 f	High-grade st. steel	10...36	IP 68 / IP 69K	100	100	159	IIT205
	M30 / L = 70	15 f	High-grade st. steel	10...36	IP 68 / IP 69K	100	100	16	IIT212
	M30 / L = 70	22 nf	High-grade st. steel	10...36	IP 68 / IP 69K	100	100	17	IIT213

M12 connector · Output function  · 3-wire · DC PNP · Wiring diagram no. 3 · Connector groups 148, 153, 184, 188, 193

	M18 / L = 46	8 f	High-grade st. steel	10...36	IP 68 / IP 69K	600	100	10	IGT204
	M12 / L = 50	7 nf	High-grade st. steel	10...36	IP 68 / IP 69K	800	100	222	IFT201
	M12 / L = 45	4 f	High-grade st. steel	10...36	IP 68 / IP 69K	800	100	8	IFT204
	M18 / L = 51	12 nf	High-grade st. steel	10...36	IP 68 / IP 69K	300	100	223	IGT201

f = flush / nf = non flush / qf = quasi-flush

Sensors for hygienic and wet areas

Type	Dimensions [mm]	Sensing range [mm]	Material	U _b [V]	Protection	f [Hz]	I _{load} [mA]	Draw- ing no.	Order no.
------	--------------------	--------------------------	----------	-----------------------	------------	-----------	---------------------------	---------------------	--------------

Cable 2 m · Output function  · 4-wire · DC PNP · Wiring diagram no. 29

	M18 / L = 80	8 nf	High-grade st. steel	10...36	IP 67	320	250	53	IG5202
---	--------------	------	----------------------	---------	-------	-----	-----	----	--------

M12 connector · Output function  · 3-wire DC PNP · 2-wire DC PNP/NPN · Wiring diagram no. 39 · Connector groups 148, 150, 153, 154, 184, 188, 190, 193

	M18 / L = 70	8 nf	High-grade st. steel	10...36	IP 68 / IP 69K	300	100	221	IGT240
---	--------------	------	----------------------	---------	----------------	-----	-----	-----	--------

















M12 connector · Output function  · 3-wire · DC PNP · Wiring diagram no. 2 · Connector groups 148, 150, 153, 154, 184, 188, 190, 193

	M8 / L = 70	1 f	High-grade st. steel	10...36	IP 67	2000	200	225	IE5215
---	-------------	-----	----------------------	---------	-------	------	-----	-----	--------

You can find wiring diagrams and scale drawings from page 134





Position sensors

Type	Dimensions [mm]	Sensing range [mm]	Material	U _b [V]	Protection	f [Hz]	I _{load} [mA]	Draw- ing no.	Order no.
M12 connector · Output function  · 3-wire · DC PNP · Wiring diagram no. 2 · Connector groups 148, 150, 153, 154, 184, 188, 190, 193									
	M8 / L = 55	2 nf	High-grade st. steel	10...36	IP 67	2000	200	226	IE5295
	M12 / L = 59	2 f	High-grade st. steel	10...36	IP 67	1100	200	227	IF5514
	M12 / L = 83	4 nf	High-grade st. steel	10...36	IP 67	400	250	69	IF5594
	M12 / L = 44	4 nf	High-grade st. steel	10...36	IP 67	1400	125	228	IF5796
	M12 / L = 59	4 nf	High-grade st. steel	10...36	IP 67	1400	250	229	IF5813
	M12 / L = 44	2 f	High-grade st. steel	10...36	IP 67	1200	250	230	IF5815
	M12 / L = 83	2 f	High-grade st. steel	10...36	IP 67	800	250	68	IF5851
	M18 / L = 90	8 nf	High-grade st. steel	10...36	IP 67	300	250	231	IG5602
	M18 / L = 76	5 f	High-grade st. steel	10...36	IP 67	500	250	232	IG5813
	M30 / L = 92	10 f	High-grade st. steel	10...36	IP 67	250	250	233	I15689
	M30 / L = 92	15 nf	High-grade st. steel	10...36	IP 67	200	250	234	I15776
M12 connector · Output function  /  · 2-wire · DC PNP/NPN · Wiring diagram no. 40 · Connector groups 148, 153, 184, 188, 193									
	M12 / L = 83	2 f	High-grade st. steel	10...55	IP 67	1100	400	68	IF5759
	M12 / L = 83	4 nf	High-grade st. steel	10...55	IP 67	1500	300	69	IF5760
	M18 / L = 77	8 nf	High-grade st. steel	10...55	IP 67	300	300	235	IG5772

Type	Dimensions [mm]	Sensing range [mm]	Material	U _b [V]	Protection	f [Hz]	I _{load} [mA]	Drawing no.	Order no.
------	--------------------	-----------------------	----------	-----------------------	------------	-----------	---------------------------	-------------	-----------

M12 connector · Output function  /  · 2-wire · DC PNP/NPN · Wiring diagram no. 40 · Connector groups 148, 153, 184, 188, 193

	M18 / L = 90	5 f	High-grade st. steel	10...55	IP 67	700	400	236	IG5806
	M30 / L = 78	15 nf	High-grade st. steel	10...55	IP 67	200	400	73	II5733
	M30 / L = 92	10 f	High-grade st. steel	10...55	IP 67	450	400	233	II5751

M12 connector · Output function  +  · 4-wire · DC PNP · Wiring diagram no. 11 · Connector groups 148, 150, 153, 154, 184, 188, 190, 193







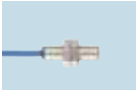

	M18 / L = 45	10 nf	High-grade st. steel	10...36	IP 67	300	250	237	IG5846
---	--------------	-------	----------------------	---------	-------	-----	-----	-----	--------

f = flush / nf = non flush / qf = quasi-flush

Sensors with ATEX approval 1D / 2G







Type	Dimensions [mm]	Sensing range [mm]	Material	U _{nom.} at 1 K Ω [V]	U _b [V]	Internal capacit. [nF]	Internal inductance [μ H]	f [Hz]	Drawing no.	Order no.
------	--------------------	-----------------------	----------	---	-----------------------	---------------------------	-----------------------------------	-----------	-------------	-----------

Cable 2 m · Output function  · 2-wire · Connection to certified intrinsically safe circuits with the max. values U = 15 V / I = 50 mA / P = 120 mW · Wiring diagram no. 30

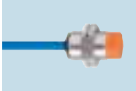
	M8 / L = 30	1 f	Brass	8.2 DC	7.5...30	80	70	2000	238	NE5001
	M12 / L = 30	2 f	PBT	8.2 DC	7.5...30	140	340	1200	239	NF5001
	M12 / L = 30	2 f	Brass	8.2 DC	7.5...30	140	340	1200	239	NF5002
	M12 / L = 30	4 nf	PBT	8.2 DC	7.5...30	140	130	1500	239	NF5003
	M12 / L = 30	4 nf	Brass	8.2 DC	7.5...30	140	130	1500	240	NF5004
	M18 / L = 33	5 f	PBT	8.2 DC	7.5...30	145	45	720	241	NG5001
	M18 / L = 33	5 f	Brass	8.2 DC	7.5...30	145	45	720	241	NG5002
	M18 / L = 33	8 nf	PBT	8.2 DC	7.5...30	155	50	300	241	NG5003

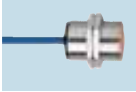
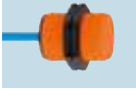





Position sensors

Type	Dimensions [mm]	Sensing range [mm]	Material	U _{nom.} at 1 K Ω [V]	U _b [V]	Internal capacit. [nF]	Internal inductance [μ H]	f [Hz]	Draw- ing no.	Order no.
Cable 2 m · Output function  · 2-wire · Connection to certified intrinsically safe circuits with the max. values U = 15 V / I = 50 mA / P = 120 mW · Wiring diagram no. 30										
	M18 / L = 33	8 nf	Brass	8.2 DC	7.5...30	155	50	300	242	NG5004
	M30 / L = 41	10 f	PBT	8.2 DC	7.5...30	145	140	450	243	NI5001
	M30 / L = 41	10 f	Brass	8.2 DC	7.5...30	145	140	450	243	NI5002
	M30 / L = 41	15 nf	PBT	8.2 DC	7.5...30	145	110	200	243	NI5003
	M30 / L = 41	15 nf	Brass	8.2 DC	7.5...30	145	110	200	244	NI5004
	40 x 12 x 26	4 nf	PBT	8.2 DC	7.5...30	110	135	400	245	NN5002
	28 x 10 x 16	2 f	PBT	8.2 DC	7.5...30	80	110	800	246	NS5002
	Ø 6.5 / L = 30	1 f	Brass	8.2 DC	7.5...30	80	70	2000	247	NT5001

f = flush / nf = non flush / qf = quasi-flush

Sensors with ATEX approval 1D / 1G / 2G

Type	Dimensions [mm]	Sensing range [mm]	Material	U _{nom.} at 1 K Ω [V]	U _b [V]	Internal capacit. [nF]	Internal inductance [μ H]	f [Hz]	Draw- ing no.	Order no.
M12 connector · Output function  · 2-wire · Connection to certified intrinsically safe circuits with the max. values U = 15 V / I = 50 mA / P = 120 mW · Wiring diagram no. 31 · Connector groups 195, 197										
	M12 / L = 50	7 nf	Brass	8.2 DC	7.5...30	210	145	700	9	NF500A
	M12 / L = 45	4 f	Brass	8.2 DC	7.5...30	210	115	700	8	NF501A
	M18 / L = 51	12 nf	Brass	8.2 DC	7.5...30	200	85	300	11	NG500A
	M18 / L = 46	8 f	Brass	8.2 DC	7.5...30	200	190	400	10	NG501A

Type	Dimensions [mm]	Sensing range [mm]	Material	U _{nom.} at 1 KΩ [V]	U _b [V]	Internal capacit. [nF]	Internal inductance [μH]	f [Hz]	Draw- ing no.	Order no.
------	--------------------	--------------------------	----------	-------------------------------------	-----------------------	------------------------------	--------------------------------	-----------	---------------------	--------------

M12 connector · Output function  · 2-wire · Connection to certified intrinsically safe circuits with the max. values U = 15 V / I = 50 mA / P = 120 mW · Wiring diagram no. 31 · Connector groups 195, 197

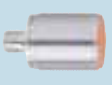
	M30 / L = 50	22 nf	Brass	8.2 DC	7.5...30	250	120	100	160	NI500A
	M30 / L = 50	15 f	Brass	8.2 DC	7.5...30	230	210	100	159	NI501A

M12 connector · Output function  · 2-wire · Connection to certified intrinsically safe circuits with the max. values U = 15 V / I = 50 mA / P = 120 mW · Wiring diagram no. 32 · Connector group 197

	40 x 40 x 66	20 f	PPE	8.2 DC	7.5...30	250	450	200	124	NM500A
	40 x 40 x 66	35 nf	PPE	8.2 DC	7.5...30	220	710	100	124	NM501A

f = flush / nf = non flush / qf = quasi-flush



Sensors with ATEX approval 3D/3G

Type	Dimensions [mm]	Sensing range [mm]	Material	U _{nom.} at 1 KΩ [V]	U _b [V]	Internal capacit. [nF]	Internal inductance [μH]	f [Hz]	Draw- ing no.	Order no.
------	--------------------	--------------------------	----------	-------------------------------------	-----------------------	------------------------------	--------------------------------	-----------	---------------------	--------------

M12 connector · Output function  · 4-wire · DC PNP · Wiring diagram no. 11 · Connector groups 196, 198

	40 x 40 x 54	40 nf	PC	10...30 DC	–	–	–	60	248	IM511A
	40 x 40 x 54	20 f	PC	10...30 DC	–	–	–	100	248	IM512A
	40 x 40 x 54	30 nf	PC	10...30 DC	–	–	–	100	248	IM513A

M12 connector · Output function  · 3-wire · DC PNP · Wiring diagram no. 2 · Connector groups 196, 198

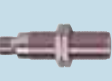
	M12 / L = 70.2	6 nf	High-grade st. steel	10...36 DC	–	–	–	500	249	IF505A
	M18 / L = 70	12 nf	High-grade st. steel	10...36 DC	–	–	–	500	209	IG511A
	M30 / L = 70	25 nf	High-grade st. steel	10...36 DC	–	–	–	250	210	I1503A
	M18 / L = 70	5 f	High-grade st. steel	10...36 DC	–	–	–	100	70	IG510A



Position sensors

Type	Dimensions [mm]	Sensing range [mm]	Material	U _{nom.} at 1 KΩ [V]	U _b [V]	Internal capacit. [nF]	Internal inductance [μH]	f [Hz]	Draw- ing no.	Order no.
M12 connector · Output function · 3-wire · DC PNP · Wiring diagram no. 2 · Connector groups 196, 198										
	M30 / L = 70	10 f	High-grade st. steel	10...36 DC	–	–	–	50	250	II502A
	M12 / L = 60	3 f	High-grade st. steel	10...36 DC	–	–	–	100	251	IF503A
M12 connector · Output function · 3-wire · DC PNP · Wiring diagram no. 3 · Connector groups 196, 198										
	M18 / L = 70	5 f	High-grade st. steel	10...36 DC	–	–	–	100	70	IG512A
	M12 / L = 60	3 f	High-grade st. steel	10...36 DC	–	–	–	100	251	IF504A

f = flush / nf = non flush / qf = quasi-flush

Sensors with ATEX approval 3D

Type	Dimensions [mm]	Sensing range [mm]	Material	U _{nom.} at 1 KΩ [V]	U _b [V]	Internal capacit. [nF]	Internal inductance [μH]	f [Hz]	Draw- ing no.	Order no.
Cable 2 m · Output function · 2-wire · AC/DC · Wiring diagram no. 14										
	M18 / L = 80	8 nf	Brass	20...250 AC/DC	–	–	–	25 / 50	252	IG001A*
Cable 2 m · Output function · 3-wire · DC PNP · Wiring diagram no. 5										
	M18 / L = 80	8 nf	Brass	10...30 DC	–	–	–	300	252	IG513A
Cable 2 m · Output function · 2-wire · DC PNP/NPN · Wiring diagram no. 42										
	M18 / L = 80	8 nf	Brass	10...30 DC	–	–	–	300	252	IG515A
Cable 6 m · Output function · 2-wire · AC/DC · Wiring diagram no. 14										
	M30 / L = 81	15 nf	Brass	20...250 AC/DC	–	–	–	25 / 50	253	II001A*
M12 connector · Output function · 4-wire · DC PNP · Wiring diagram no. 11 · Connector groups 196, 198										
	M18 / L = 80	10 nf	High-grade st. steel	10...30 DC	–	–	–	300	254	IG514A

Type	Dimensions [mm]	Sensing range [mm]	Material	U _{nom.} at 1 kΩ [V]	U _b [V]	Internal capacit. [nF]	Internal inductance [μH]	f [Hz]	Draw- ing no.	Order no.
Terminals · Output function  · 4-wire · DC · Wiring diagram no. 33										
	40 x 40 x 105	20 f	PC	10...30 DC	-	-	-	100	255	IM510A
Terminals · Output function  · 4-wire · DC · Wiring diagram no. 34										
	40 x 40 x 105	20 f	PC	10...30 DC	-	-	-	100	255	IM509A
Terminals · Output function  · 2-wire · AC/DC · Wiring diagram no. 46										
	105 x 80 x 42	60 nf	PPE	20...250 AC/DC	-	-	-	4	256	ID002A*
Terminals · Output function  · 2-wire · AC/DC · Wiring diagram no. 50										
	40 x 40 x 105	40 nf	PC	20...250 AC/DC	-	-	-	10	255	IM002A*
Terminals · Output function  · 2-wire · DC · Wiring diagram no. 51										
	40 x 40 x 105	20 f	PC	10...55 DC	-	-	-	100	255	IM508A
Terminals · Output function  · 3-wire · AC/DC · Wiring diagram no. 50										
	40 x 40 x 105	20 f	PC	20...250 AC/DC	-	-	-	10	255	IM001A*
Terminals · Output function  · 3-wire · DC PNP · Wiring diagram no. 45										
	105 x 80 x 42	60 nf	PPE	10...30 DC	-	-	-	100	256	ID502A
Terminals · Output function  · 4-wire · DC · Wiring diagram no. 52										
	40 x 40 x 105	20 f	PC	10...30 DC	-	-	-	100	255	IM506A
	40 x 40 x 105	40 nf	PC	10...30 DC	-	-	-	100	255	IM507A

f = flush / nf = non flush / qf = quasi-flush

*** Note on use of miniature fuses for electrical connection**

Miniature fuse to IEC60127-2 sheet 1, ≤ 2 A (fast acting) Recommendation: check the unit for reliable function after a short circuit.



Position sensors

Sensors with ATEX approval 2D / 3G

Type	Dimensions [mm]	Sensing range [mm]	Material	U _{nom.} at 1 KΩ [V]	U _b [V]	Internal capacit. [nF]	Internal inductance [μH]	f [Hz]	Drawing no.	Order no.
------	--------------------	-----------------------	----------	-------------------------------------	-----------------------	---------------------------	-----------------------------	-----------	-------------	-----------

M12 connector · Output function  · 3-wire · DC PNP · Wiring diagram no. 35 · Connector groups 196, 198

	M30 / L = 70	10 f	High-grade st. steel	10...36 DC	-	-	-	50	250	I1504A
---	--------------	------	----------------------	------------	---	---	---	----	-----	--------

Terminals · Output function  /  · 3-wire · DC PNP · Wiring diagram no. 53







	105 x 80 x 42	60 nf	modified PPE	10...30 DC	-	-	-	100	256	ID503A
---	---------------	-------	--------------	------------	---	---	---	-----	-----	--------

f = flush / nf = non flush / qf = quasi-flush





Switching amplifiers with ATEX approval

Type	Description	Order no.
	Switching amplifier for Namur sensors according to 94/9/EG (ATEX) · ATEX approval · Group II, category (1) G D · 1-channel · Relay output · Programmable output function · Short-circuit and wire monitoring	N0031A
	Switching amplifier for Namur sensors according to 94/9/EG (ATEX) · ATEX approval · Group II, category (1) G D · 2-channel · Relay outputs · Programmable output function · Short-circuit and wire monitoring	N0032A
	Switching amplifier for Namur sensors according to 94/9/EG (ATEX) · ATEX approval · Group II, category (1) G D · 2-channel · Relay outputs · Programmable output function · Short-circuit and wire monitoring	N0033A
	Switching amplifier for Namur sensors according to 94/9/EG (ATEX) · ATEX approval · Group II, category (1) G D · 1-channel · Relay output · Programmable output function · Short-circuit and wire monitoring	N0530A
	Switching amplifier for Namur sensors according to 94/9/EG (ATEX) · ATEX approval · Group II, category (1) G D · 1-channel · Transistor outputs · Programmable output function · Short-circuit and wire monitoring	N0531A
	Switching amplifier for Namur sensors according to 94/9/EG (ATEX) · ATEX approval · Group II, category (1) G D · 2-channel · Optocoupler output · Programmable output function · Short-circuit and wire monitoring	N0532A
	Switching amplifier for Namur sensors according to 94/9/EG (ATEX) · ATEX approval · Group II, category (1) G D · 2-channel · Relay outputs · Programmable output function · Short-circuit and wire monitoring	N0533A
	Switching amplifier for Namur sensors according to 94/9/EG (ATEX) · ATEX approval · Group II, category (1) G D · 2-channel · Transistor outputs · Programmable output function · Short-circuit and wire monitoring	N0534A

Accessories for sensors with smooth sleeve



Type	Description	Order no.
	Mounting clip · Ø 12 mm · for smooth body switches - Ø 12 mm · Form V · Housing materials: stainless steel	E11530
	Mounting clip · Ø 18 mm · for smooth body switches - Ø 18 mm · Form V · Housing materials: stainless steel	E11531
	Mounting clamp · Ø 4 mm · Housing materials: TPE	E10204
	Mounting clamp · Ø 6.5 mm · Housing materials: PPE	E10014
	Mounting clamp · Ø 20 mm · Housing materials: PA	E10192
	Mounting clamp · Ø 34 mm · Housing materials: PA	E10193
	Mounting clamp · Ø 20 mm · Housing materials: Mounting clamp: PBT / socket screw: steel galvanised	E10016
	Mounting clamp · Ø 34 mm · Housing materials: PBT	E10017
	Limit plungers · for type Ø 6.5 mm · with Sn = 1 mm f · Housing materials: Limit plungers: free cutting steel / plunger: C45K hardened on front / nut: Brass nickel-plated	E10155

Accessories for threaded M8 housings











Type	Description	Order no.
	Angle bracket · for type M8 · Housing materials: stainless steel	E10734
	Mounting clamp · Ø 8 mm · Housing materials: aluminium black anodised	E10221
	Mounting clamp · Ø 8 mm · with end stop · for type M8 · Housing materials: PC	E11521
	Mounting sleeve · M12 x 1 - Ø 8 mm · 32 mm · with end stop · for type M8 · Housing materials: Brass special coating	E10848

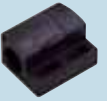

Position sensors











Type	Description	Order no.
	Mounting sleeve · M12 x 1 - Ø 8 mm · 42 mm · with end stop · for type M8 · Housing materials: Brass special coating	E10849
	Limit plungers · for types M8 x 1 · with Sn = 1 mm f, 2 mm f and 3 mm f · Housing materials: Limit plungers: free cutting steel / plunger: C45K hardened on front / nut: Brass nickel-plated	E10154

Accessories for threaded M12 housings

Type	Description	Order no.
	Angle bracket · for type M12 · Housing materials: stainless steel	E10735
	Mounting clip · O-shaped · for type M12 · Housing materials: stainless steel	E11533
	Mounting clamp · Ø 12 mm · Housing materials: PBT	E10015
	Mounting clamp · Ø 12 mm · with end stop · for type M12 · Housing materials: PC	E11047
	Mounting clamp · Ø 12 mm · with end stop · For sensors with 45° chamfer · for type M12 · Housing materials: PC	E11994
	Mounting sleeve · M16 x 1 - Ø 12 mm · 45 mm · with end stop · for type M12 · Housing materials: Brass nickel-plated	E10741
	Mounting sleeve · M16 x 1 - Ø 12 mm · 34 mm · with end stop · for type M12 · Housing materials: Brass nickel-plated	E10806
	Mounting sleeve · M16 x 1 - Ø 12 mm · with end stop · for type M12 · Housing materials: Brass nickel-plated	E11114
	Mounting sleeve · M16 x 1 - Ø 12 mm · 33.5 mm · with end stop · for type M12 · Housing materials: Brass anti-spatter / nut: Brass anti-spatter	E12452
	Lock nuts metal · M12 x 1 · Housing materials: Brass nickel-plated	E10024
	Lock nuts metal · M12 x 1 · Housing materials: stainless steel 316Ti / 1.4571	E10025

Type	Description	Order no.
	serrated washer · Ø 13 mm / Ø 18 mm · for type M12 · Housing materials: steel anti-spatter	E12412

Accessories for threaded M18 housings









Type	Description	Order no.
	Angle bracket · for type M18 · Housing materials: stainless steel	E10736
	Mounting clip · O-shaped · for type M18 · Housing materials: stainless steel	E11534
	Mounting clamp · Ø 20 mm - Ø 18 mm · with reducing bush · for type M18 · Housing materials: PBT	E10076
	Mounting clamp · Ø 18 mm · with end stop · for type M18 · Housing materials: PC	E11048
	Mounting clamp · Ø 18 mm · with end stop · For sensors with 45° chamfer · for type M18 · Housing materials: PC	E11995
	Mounting sleeve · M24 x 1.5 - Ø 18 mm · 58 mm · with end stop · for type M18 · Housing materials: Brass nickel-plated	E10742
	Mounting sleeve · M24 x 1.5 - Ø 18 mm · 36 mm · with end stop · for type M18 · Housing materials: Brass nickel-plated	E10807
	Mounting sleeve · M22 x 1 - Ø 18 mm · with end stop · for type M18 · Housing materials: Brass white bronze coated	E11115
	Mounting sleeve · M22 x 1 - Ø 18 mm · 33.5 mm · with end stop · for type M18 · Housing materials: Brass anti-spatter / nut: Brass anti-spatter	E12453
	Plastic nut for flow plate · M18 x 1 · Housing materials: POM	E19503
	Lock nuts metal · M18 x 1 · Housing materials: Brass nickel-plated	E10027
	Lock nuts metal · M18 x 1 · Housing materials: stainless steel 316Ti / 1.4571	E10028

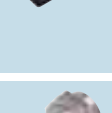

Position sensors

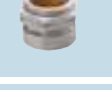
Type	Description	Order no.
	serrated washer · Ø 19 mm / Ø 27 mm · for type M18 · Housing materials: steel anti-spatter	E12413









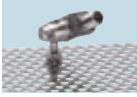

Accessories for threaded M30 housings

Type	Description	Order no.
	Angle bracket · for type M30 · Housing materials: stainless steel	E10737
	Mounting clamp · Ø 34 mm - Ø 30 mm · with reducing bush · for type M30 · Housing materials: PBT	E10077
	Mounting clamp · Ø 30 mm · with end stop · for type M30 · Housing materials: PC	E11049
	Mounting clamp · Ø 30 mm · with end stop · For sensors with 45° chamfer · for type M30 · Housing materials: PC	E11996
	Mounting sleeve · M36 x 1.5 - Ø 30 mm · 58 mm · with end stop · for type M30 · Housing materials: Brass nickel-plated	E10743
	Mounting sleeve · M36 x 1.5 - Ø 30 mm · 36 mm · with end stop · for type M30 · Housing materials: Brass nickel-plated	E10808
	Mounting sleeve · M36 x 1.5 - Ø 30 mm · 33.5 mm · with end stop · for type M30 · Housing materials: Brass anti-spatter / nut: Brass anti-spatter	E12454
	Lock nuts metal · M30 x 1.5 · Housing materials: Brass nickel-plated	E10030
	Lock nuts metal · M30 x 1.5 · Housing materials: stainless steel 316Ti / 1.4571	E10031
	serrated washer · Ø 31.6 mm / Ø 45 mm · for type M30 · Housing materials: steel anti-spatter	E12414

Accessories for rectangular housings

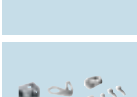
Type	Description	Order no.
	Mounting bracket · with integrated snap-on rail · for type IDC · Housing materials: stainless steel	E10730

System components

Type	Description	Order no.
	Mounting set · Ø 18.5 mm · Clamp mounting · Free-standing M10 · for type OG, IG, KG · Housing materials: clamp: diecast zinc / fixture: steel	E20718
	Mounting set · Ø 18.5 mm · Clamp mounting · Free-standing M10 · for type OG, IG, KG · Housing materials: clamp: diecast zinc / fixture: steel	E20719
	Mounting set · Ø 12.2 mm · Clamp mounting · free-standing M8 · for type OF, IF · Housing materials: fixture: stainless steel 316Ti / 1.4571 / clamp: diecast zinc	E20856
	Mounting set · Ø 12.2 mm · Clamp mounting · free-standing M8 · for type OF, IF · Housing materials: fixture: stainless steel 316Ti / 1.4571 / clamp: stainless steel	E20857
	Mounting set · Ø 12.2 mm · Clamp mounting · free-standing M8 · for type OF, IF · Housing materials: fixture: stainless steel 316Ti / 1.4571 / clamp: diecast zinc	E20860
	Mounting set · Ø 12.2 mm · Clamp mounting · free-standing M8 · for type OF, IF · Housing materials: fixture: stainless steel 316Ti / 1.4571 / clamp: stainless steel	E20861
	Mounting set · Ø 12.2 mm · Clamp mounting · aluminium profile · for type OF, IF · Housing materials: fixture: stainless steel 316Ti / 1.4571 / clamp: diecast zinc / Cube: diecast zinc	E20864
	Mounting set · Ø 12.2 mm · Clamp mounting · aluminium profile · for type OF, IF · Housing materials: fixture: stainless steel 316Ti / 1.4571 / clamp: diecast zinc / Cube: diecast zinc	E20865
	Mounting set · Ø 18.5 mm · Clamp mounting · aluminium profile · for type OG, IG, KG · Housing materials: fixture: stainless steel 316Ti / 1.4571 / clamp: diecast zinc / Cube: diecast zinc	E20866
	Mounting set · Ø 18.5 mm · Clamp mounting · aluminium profile · for type OG, IG, KG · Housing materials: fixture: stainless steel 316Ti / 1.4571 / clamp: diecast zinc / Cube: diecast zinc	E20867
	Mounting set · Ø 18.5 mm · Clamp mounting · Free-standing M10 · for type OG, IG, KG · Housing materials: fixture: stainless steel 316Ti / 1.4571 / clamp: stainless steel	E20869
	Mounting set · Ø 18.5 mm · Clamp mounting · Free-standing M10 · for type OG, IG, KG · Housing materials: fixture: stainless steel 316Ti / 1.4571 / clamp: stainless steel	E20870
	Mounting set · Ø 30.2 mm · Clamp mounting · free-standing M12 · for type OI, II, KI · Housing materials: fixture: stainless steel 316Ti / 1.4571 / clamp: diecast zinc	E20873
	Mounting set · Ø 30.2 mm · Clamp mounting · free-standing M12 · for type OI, II, KI · Housing materials: fixture: stainless steel 316Ti / 1.4571 / clamp: stainless steel	E20874



Position sensors

Type	Description	Order no.
------	-------------	-----------



Mounting set · Ø 30.2 mm · Clamp mounting · aluminium profile · for type II, KI, OI, OI · Housing materials: fixture: stainless steel 316Ti / 1.4571 / clamp: diecast zinc / Cube: diecast zinc

E20875

Wiring diagrams

Core colours

BN brown
 BU blue
 BK black
 WH white

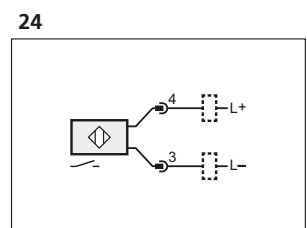
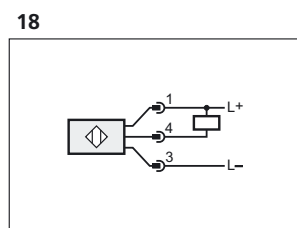
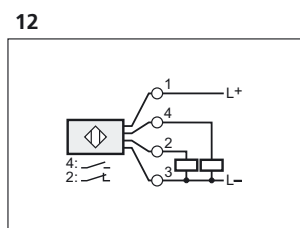
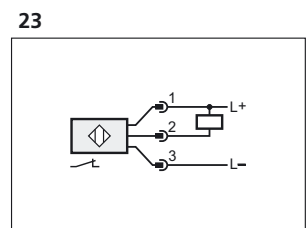
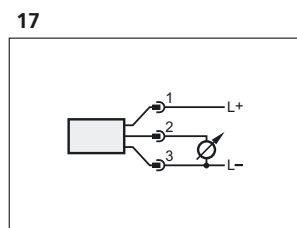
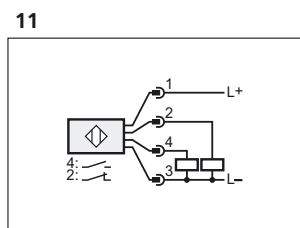
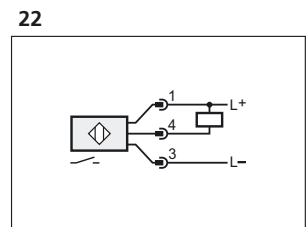
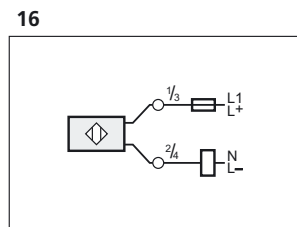
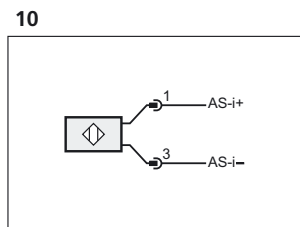
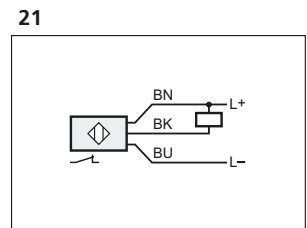
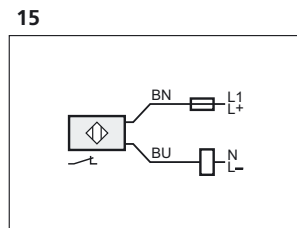
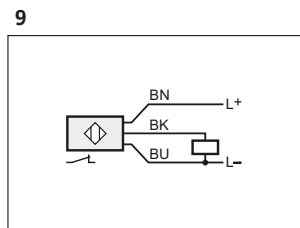
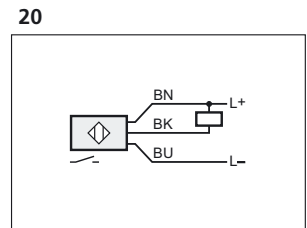
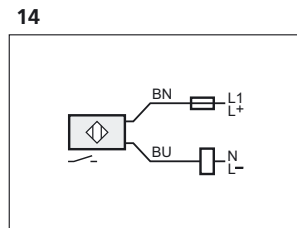
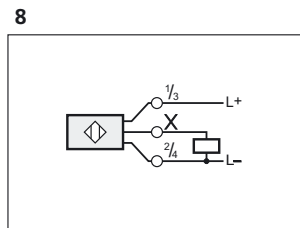
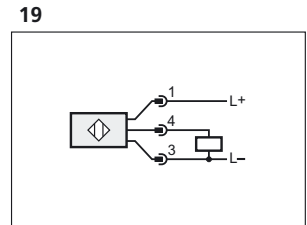
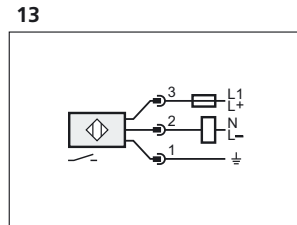
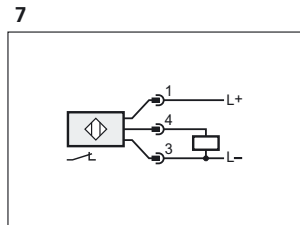
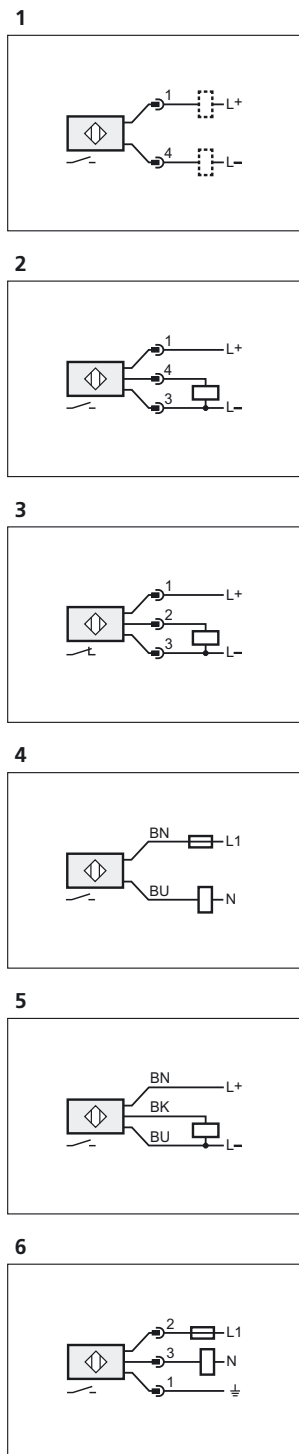

Wiring diagrams

25

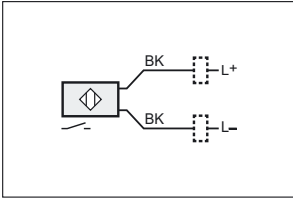

28

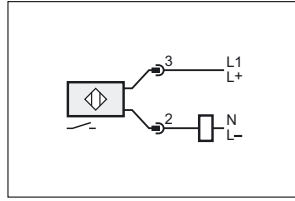

31

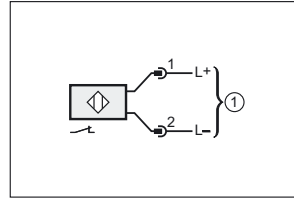

34

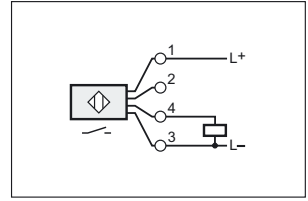

26

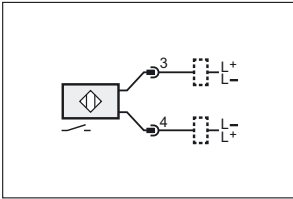

29

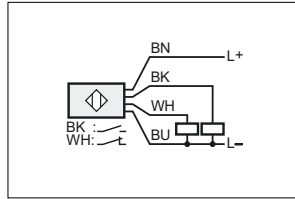

1: connection to NAMUR-amplifier

35

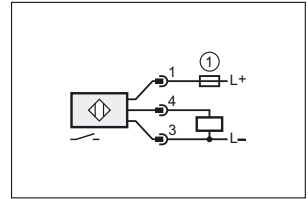

1: fuse

27

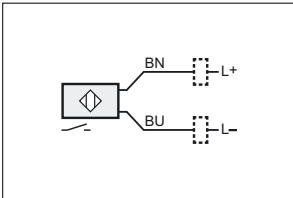

30

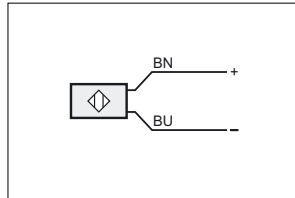

32

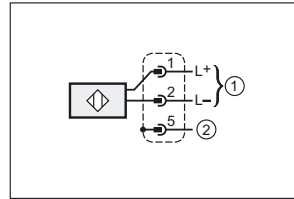

1: connection to NAMUR-amplifier, 2: Potential equalisation plug housing

33

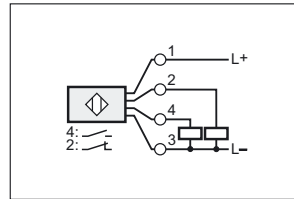

36

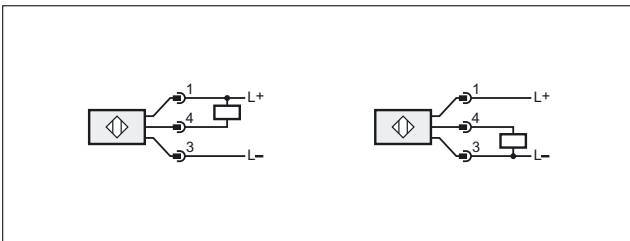

39

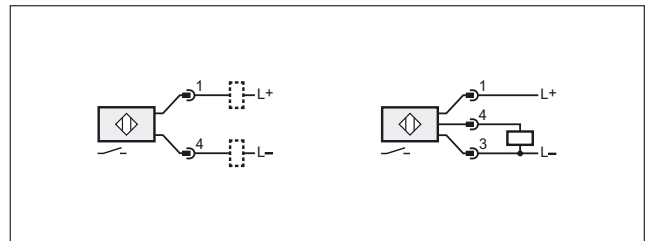

37

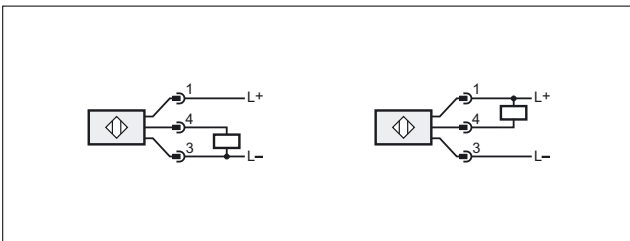

40

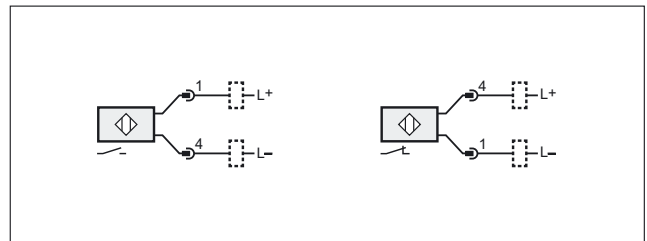

38

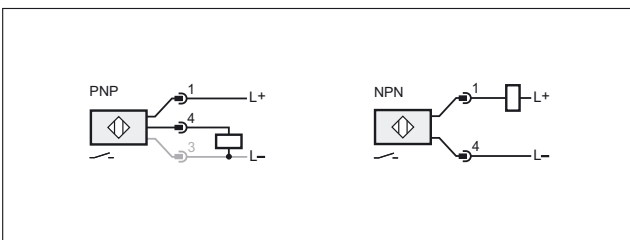

41

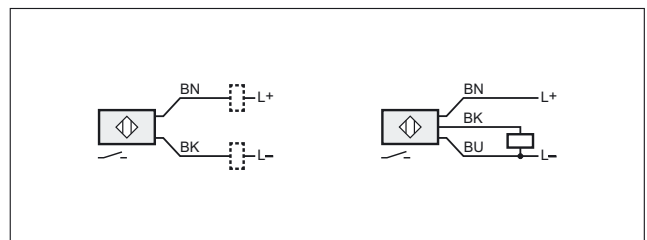



Position sensors

Wiring diagrams

42

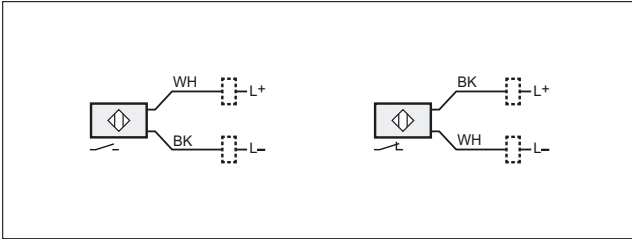

48

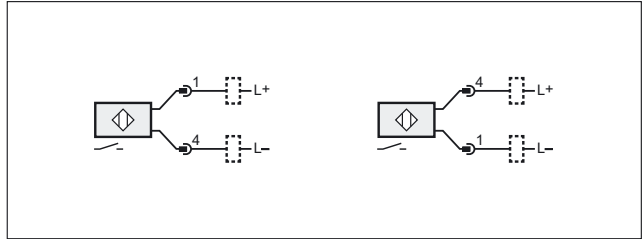

43

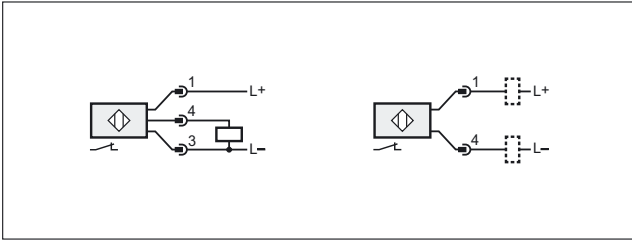

49

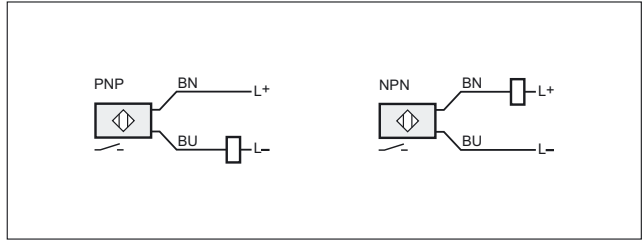

44

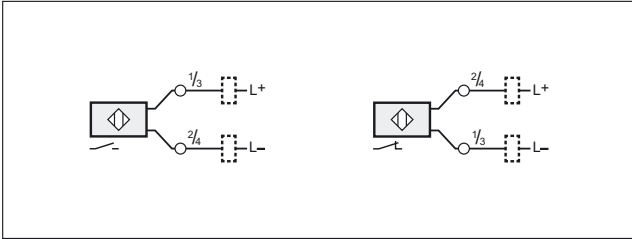

50

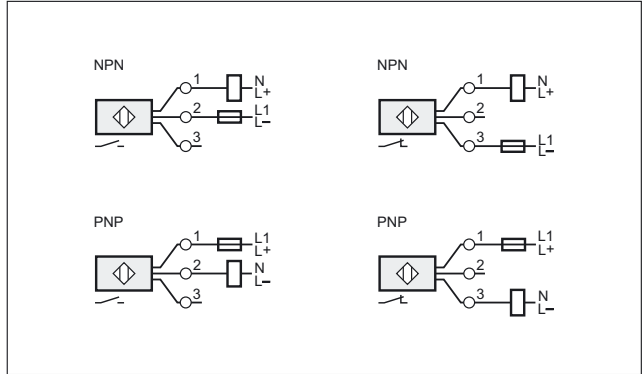

45

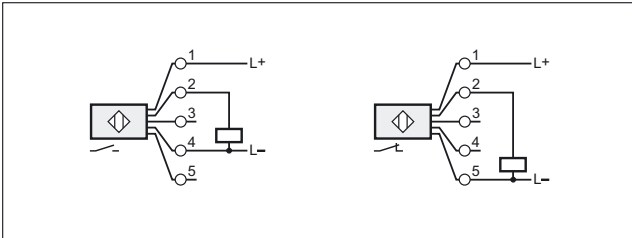

51

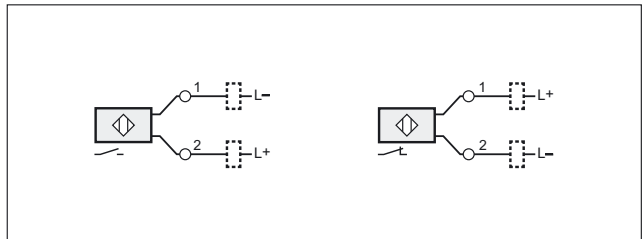

46

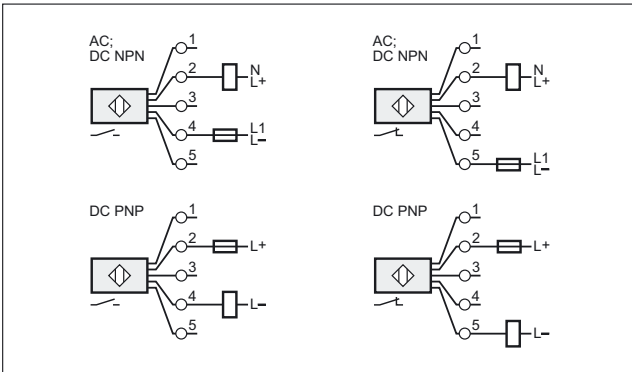

52

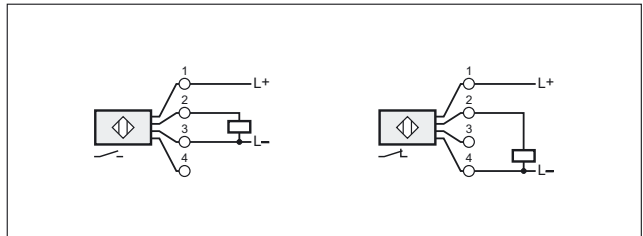

47

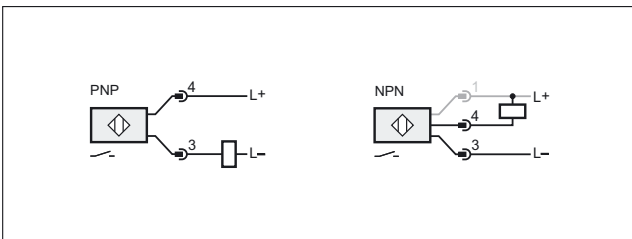

53

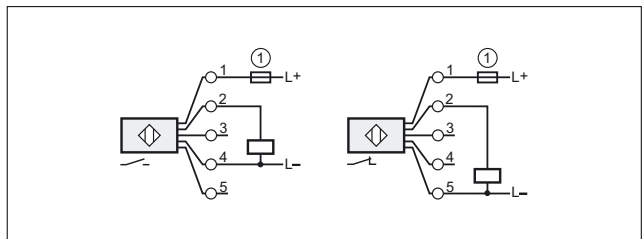

1: fuse

Scale drawings / drawing no. – CAD download: www.ifm.com

1

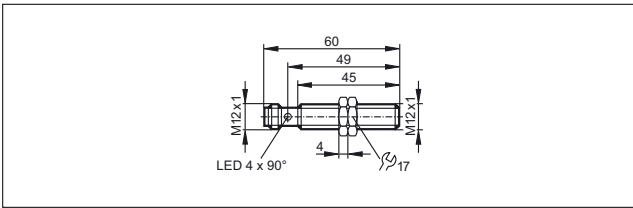

2

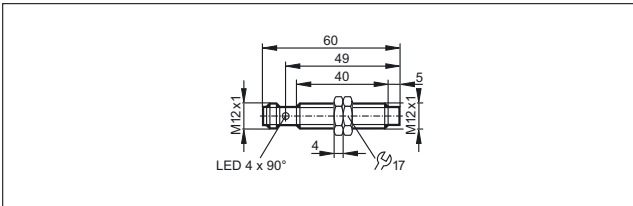

3

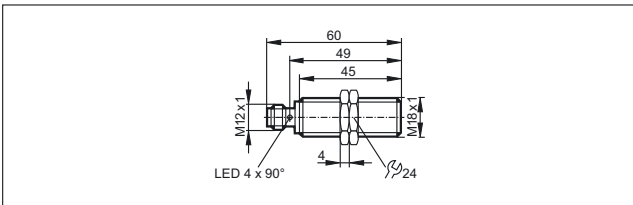

4

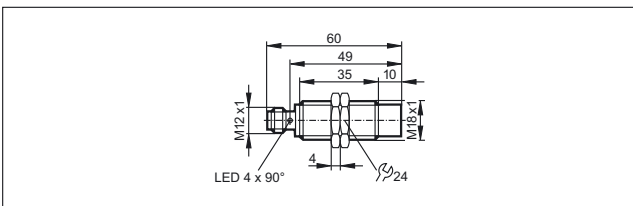

5

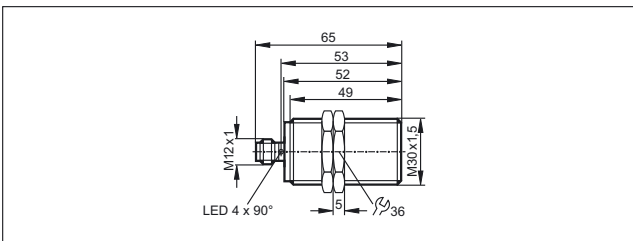

6

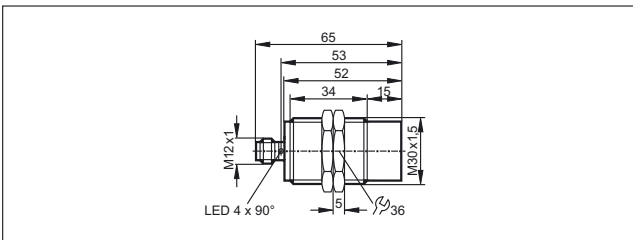

7

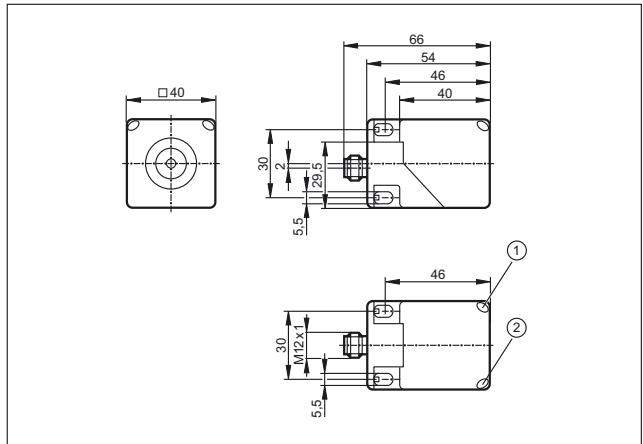

1: LED yellow, 2: LED green

8

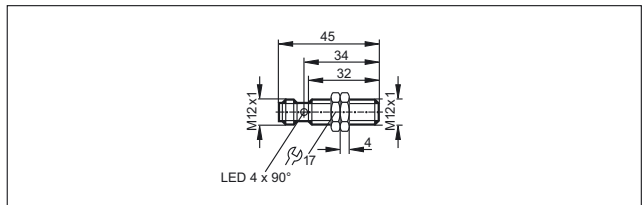

9

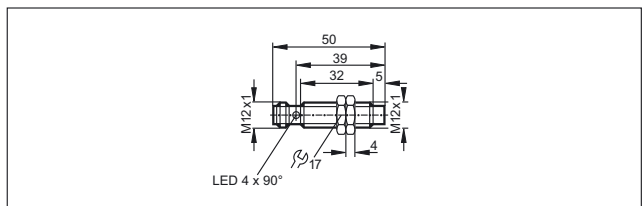

10

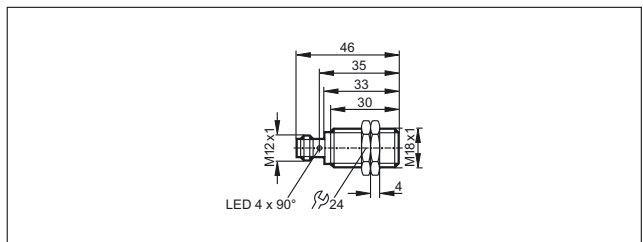

11

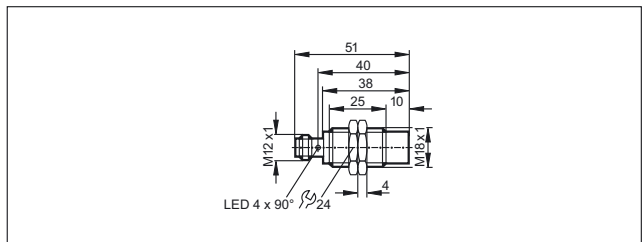

12

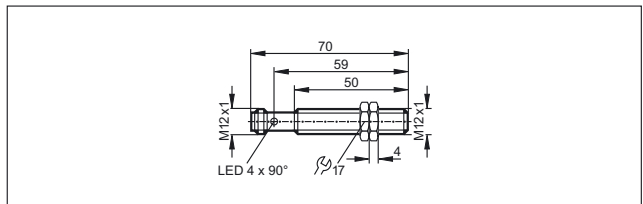



Position sensors

Scale drawings / drawing no. – CAD download: www.ifm.com

13

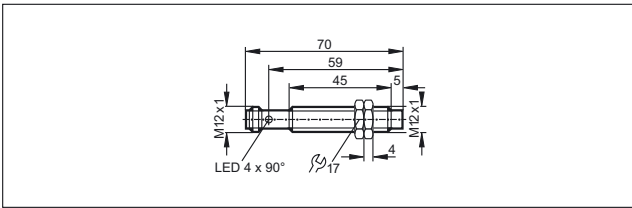

19

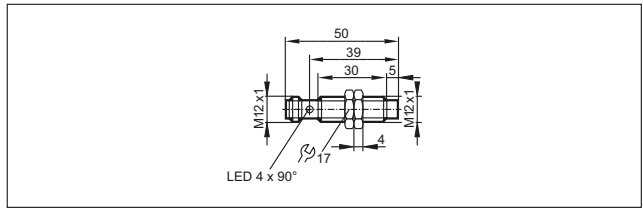

14

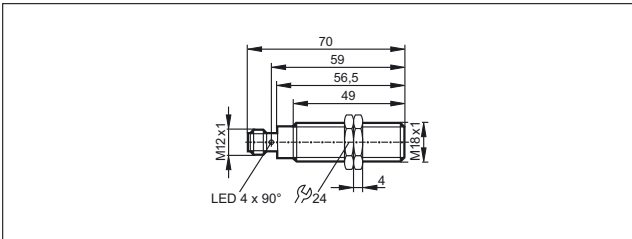

20

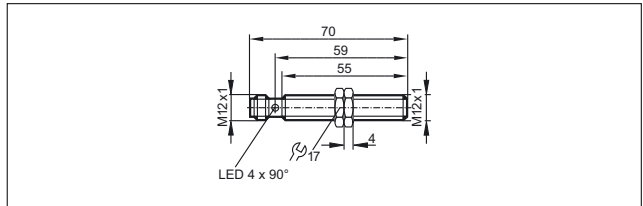

15

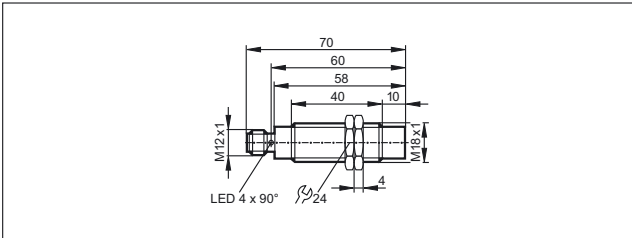

21

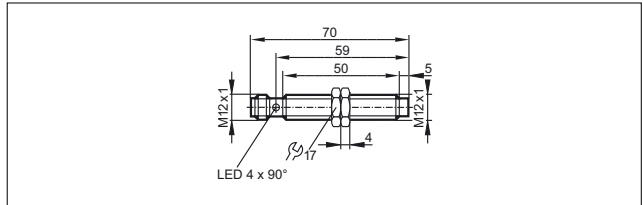

16

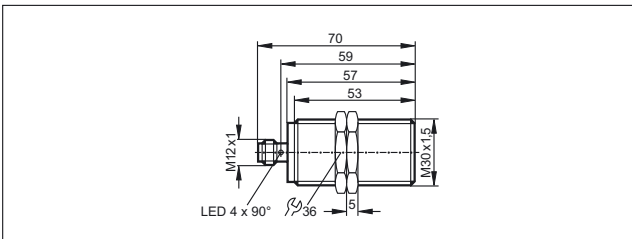

22

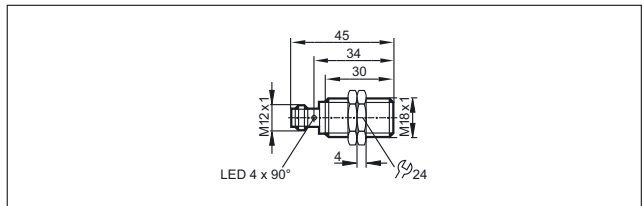

17

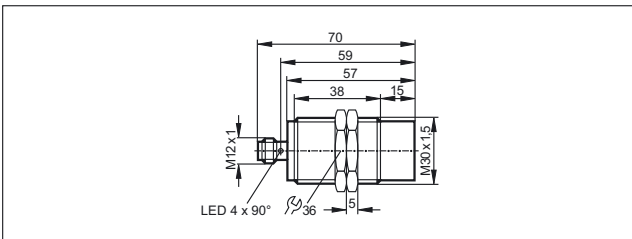

23

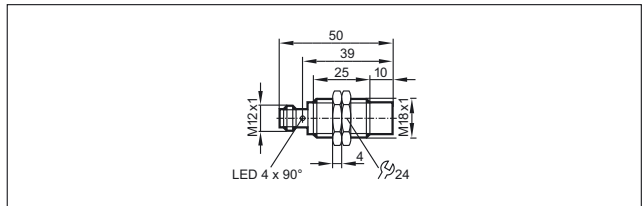

18

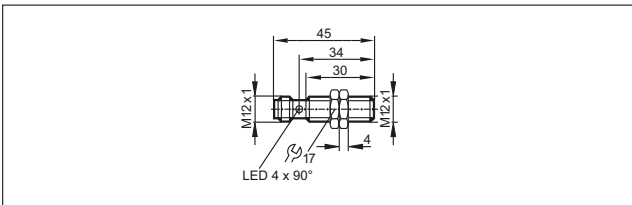

24

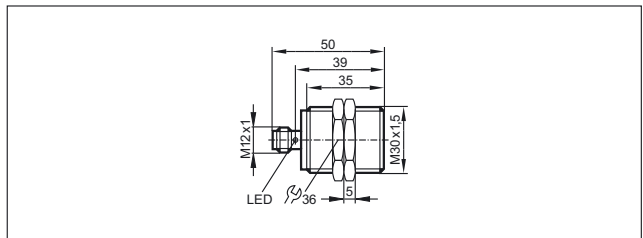

25

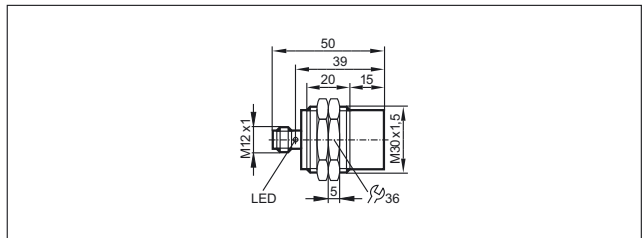

Scale drawings / drawing no. – CAD download: www.ifm.com

26

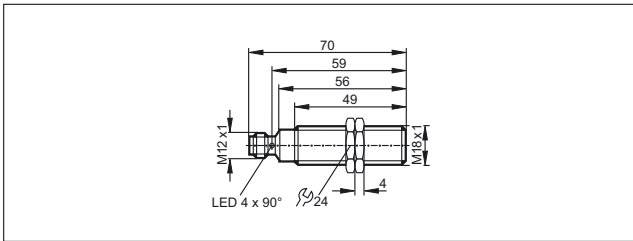

27

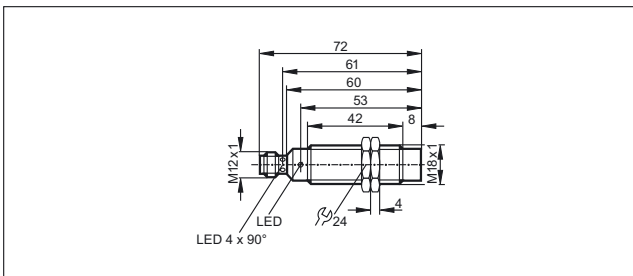

28

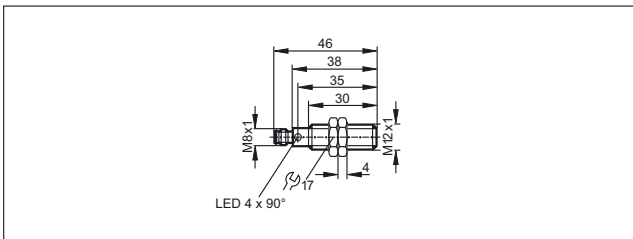

29

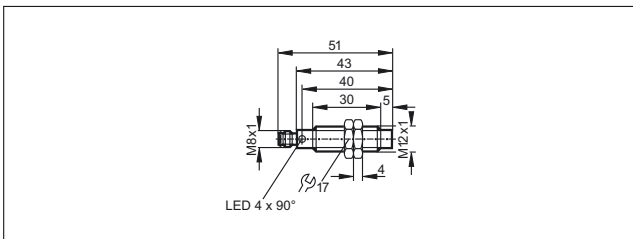

30

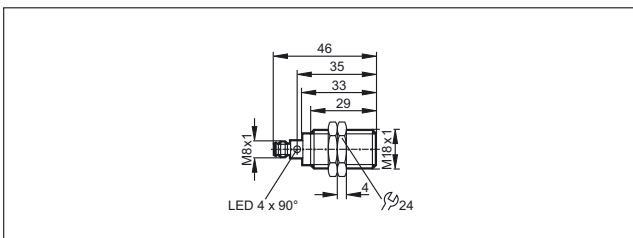

31

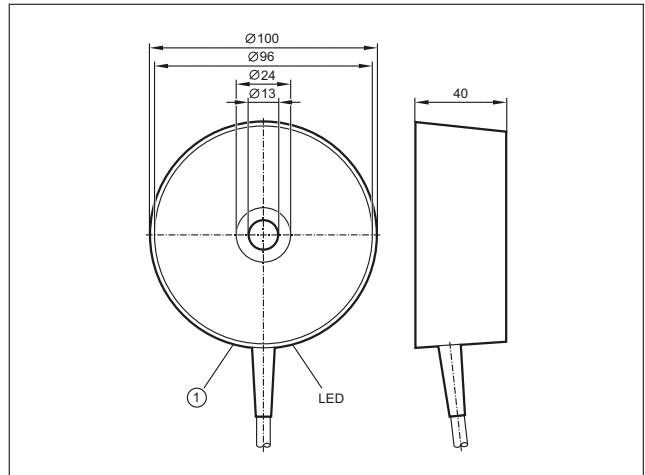

1: potentiometer

32

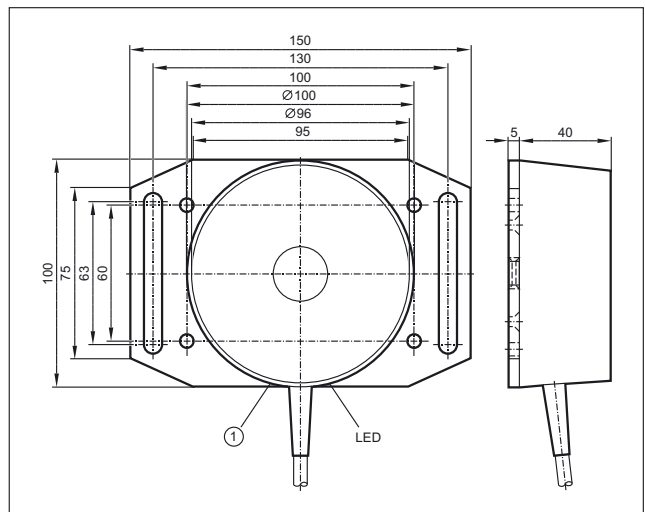

1: potentiometer

33

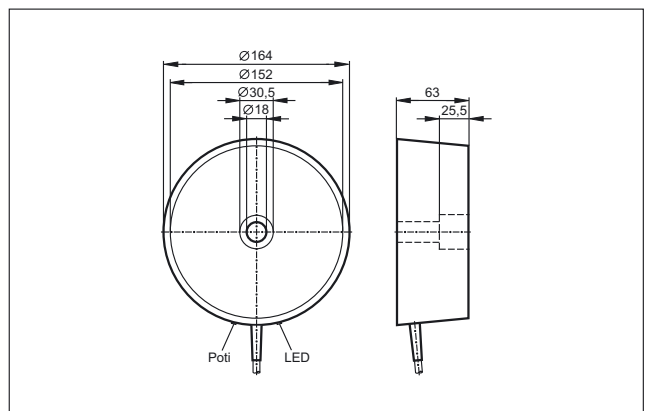



Position sensors

Scale drawings / drawing no. – CAD download: www.ifm.com

34

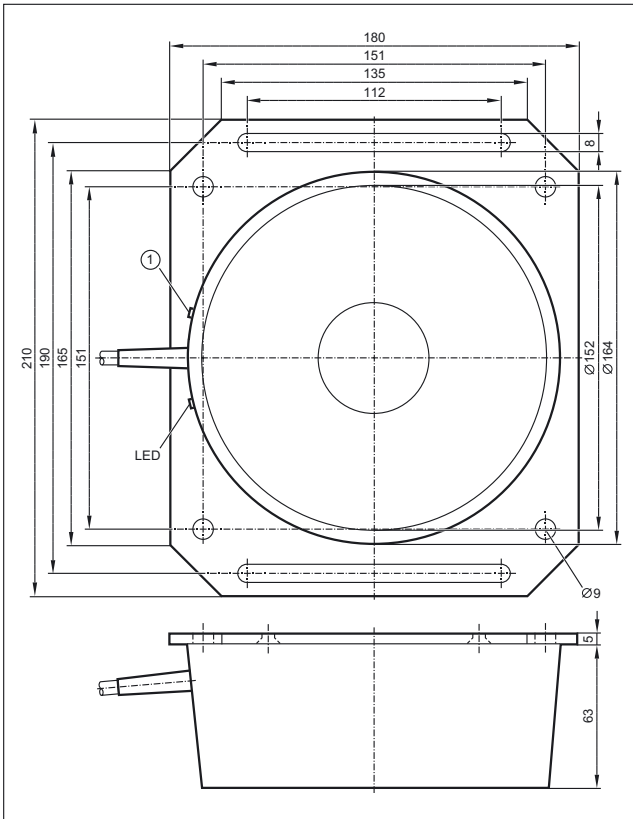

1: potentiometer

35

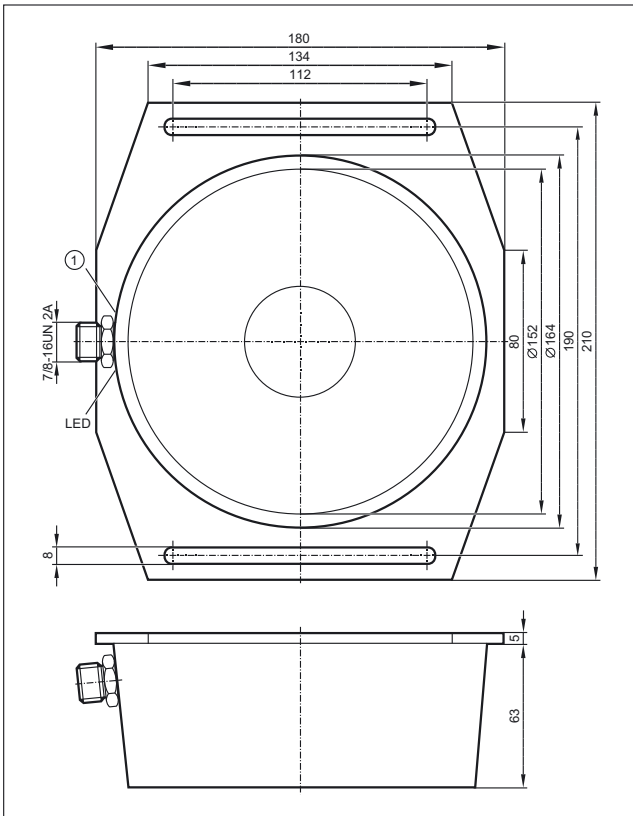

1: potentiometer

36

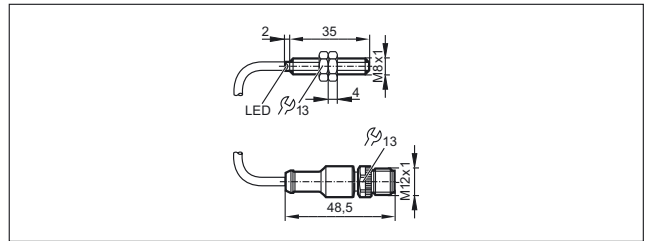

37

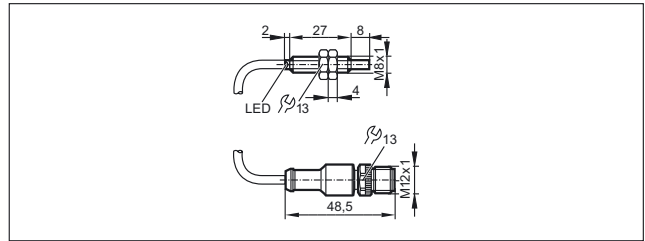

38

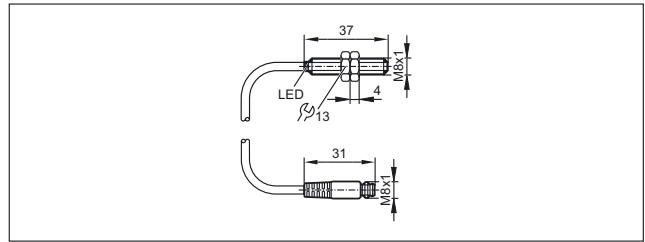

39

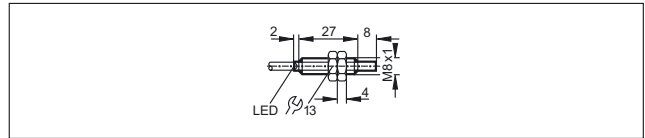

40

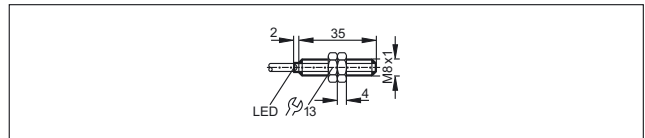

41

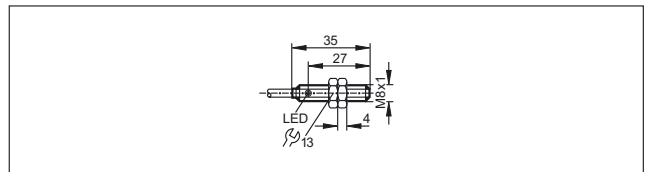

42

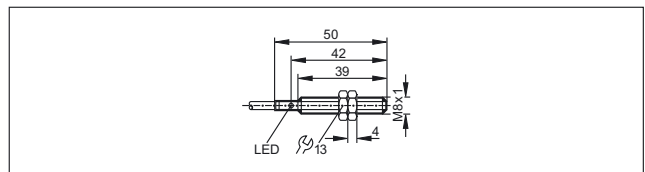

43

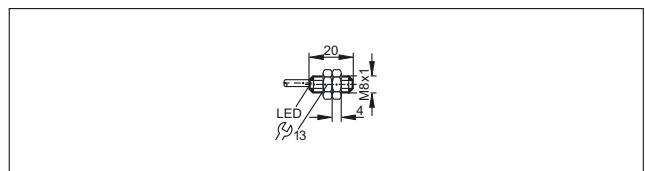

Scale drawings / drawing no. – CAD download: www.ifm.com

44

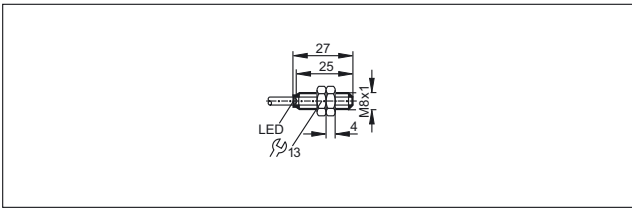

45

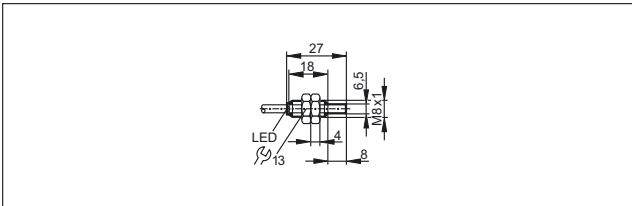

46

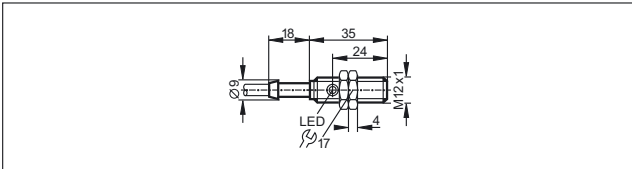

47

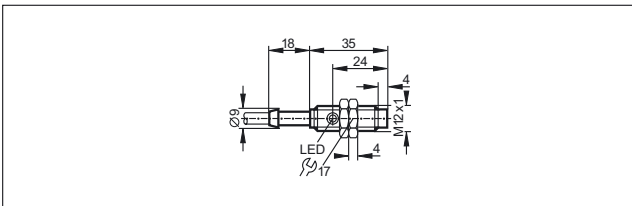

48

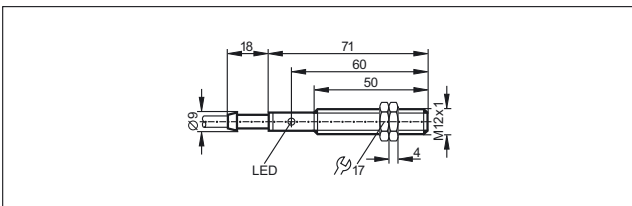

49

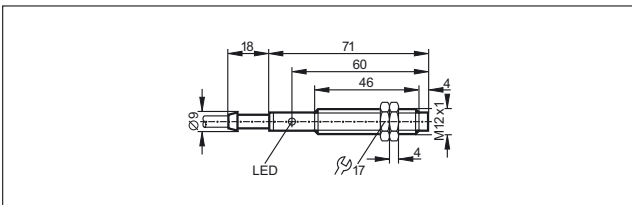

50

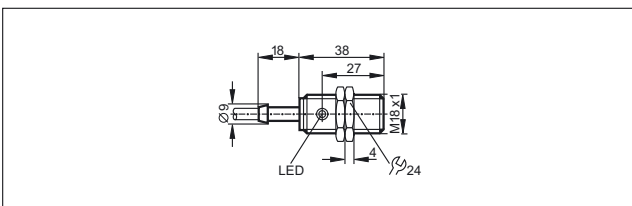

51

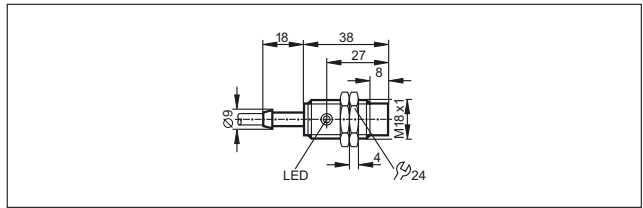

52

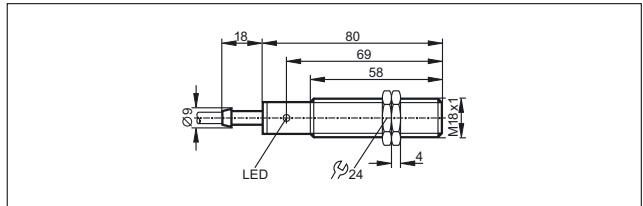

53

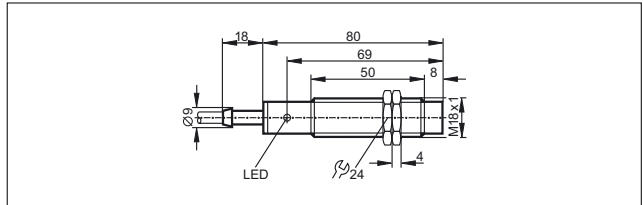

54

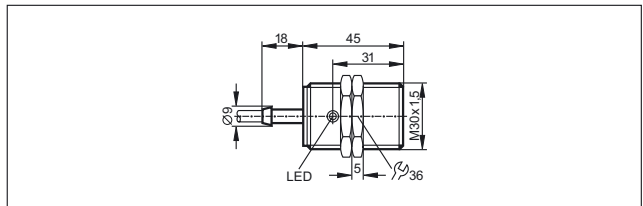

55

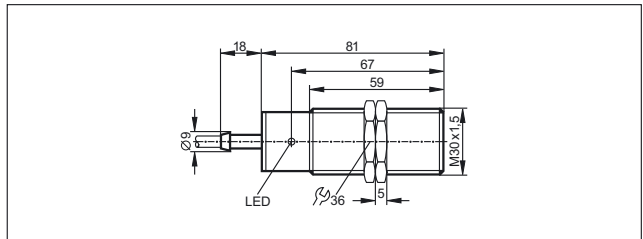

56

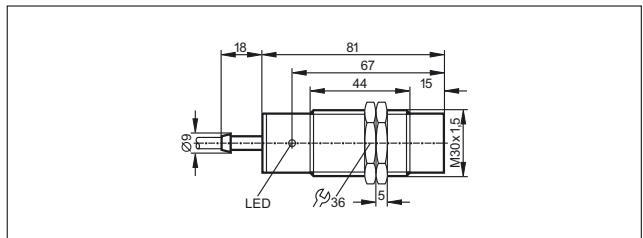

57

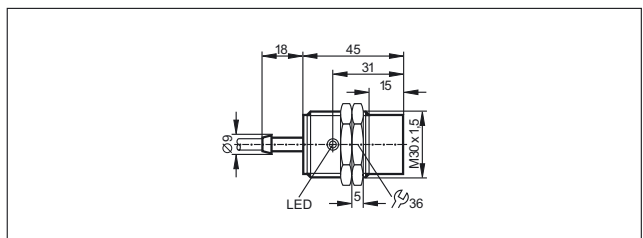



Position sensors

Scale drawings / drawing no. – CAD download: www.ifm.com

58

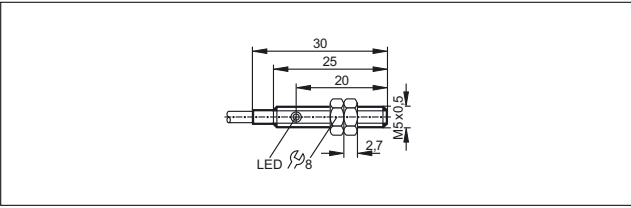

65

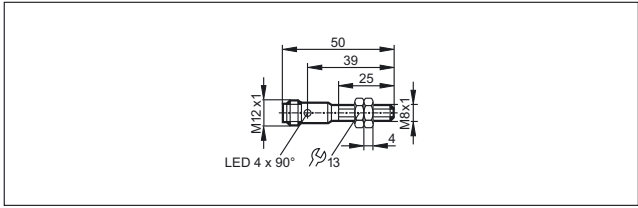

59

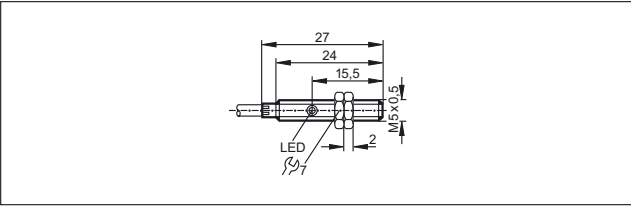

66

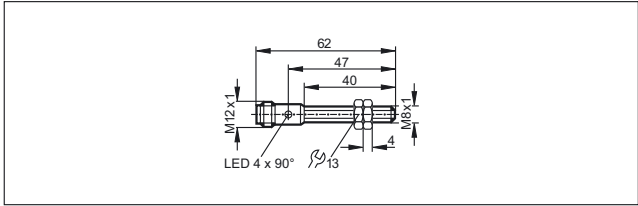

60

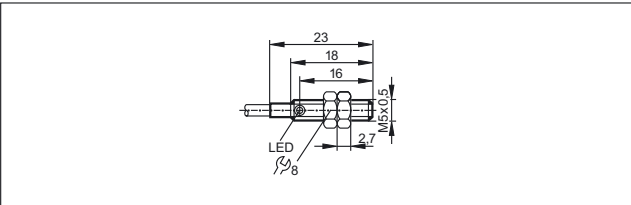

67

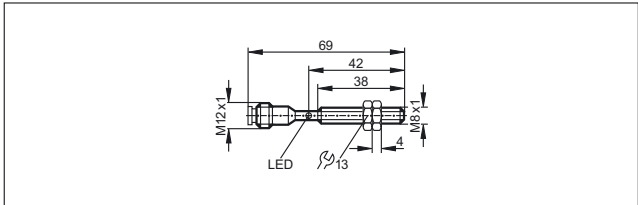

61

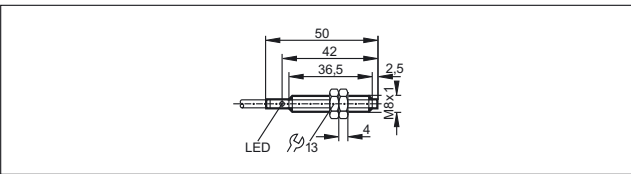

68

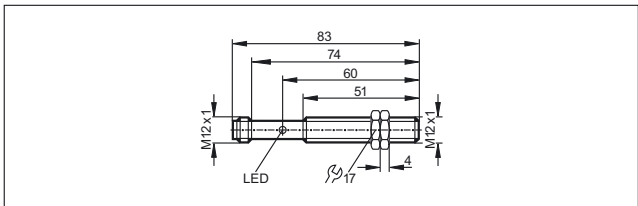

62

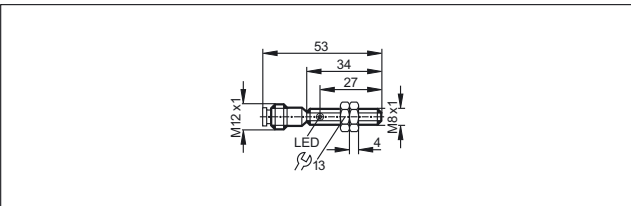

69

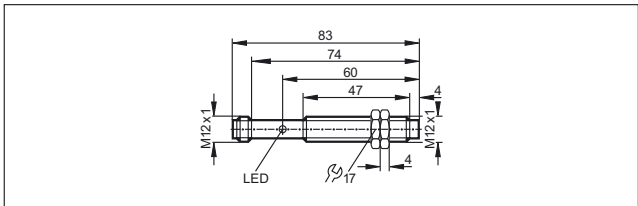

63

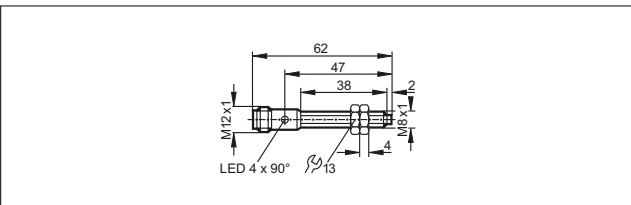

70

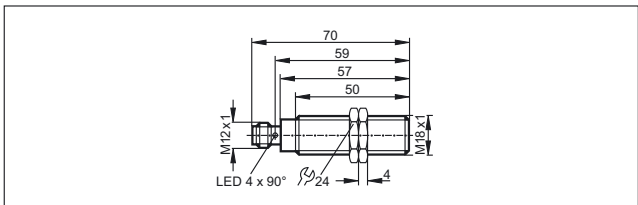

64

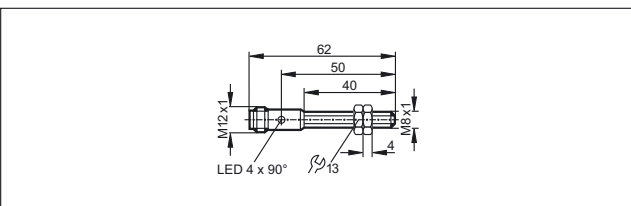

71

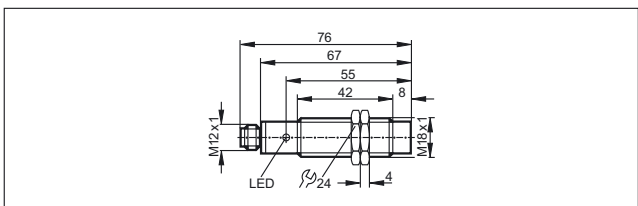

Scale drawings / drawing no. – CAD download: www.ifm.com

72

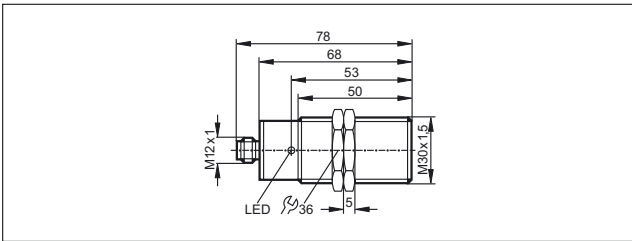

73

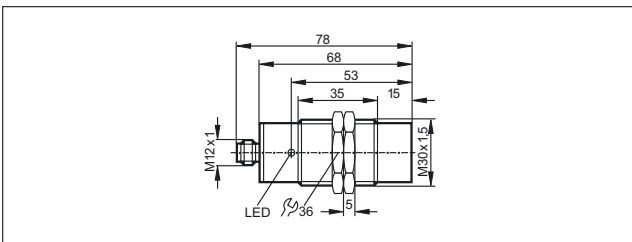

74

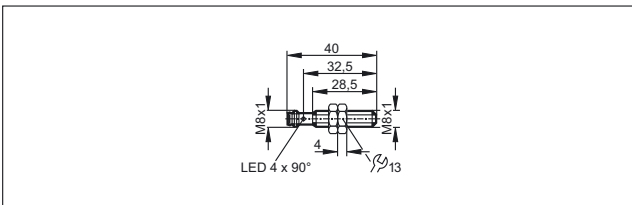

75

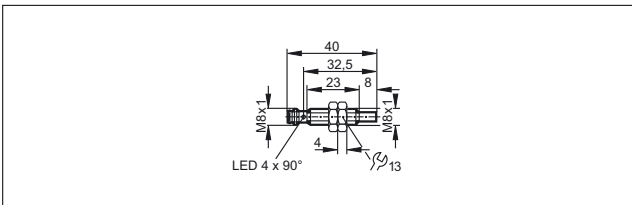

76

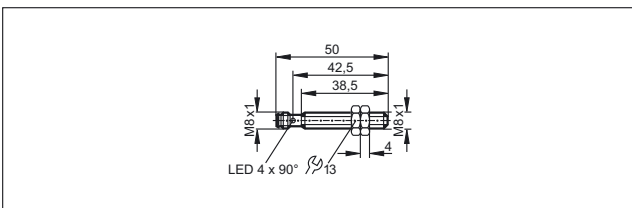

77

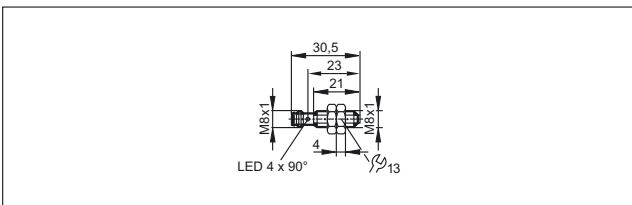

78

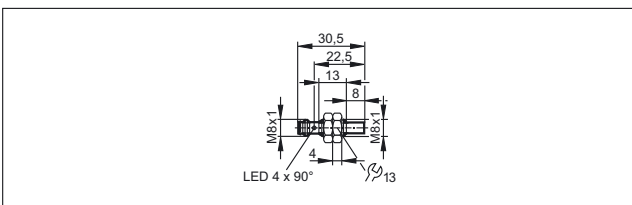

79

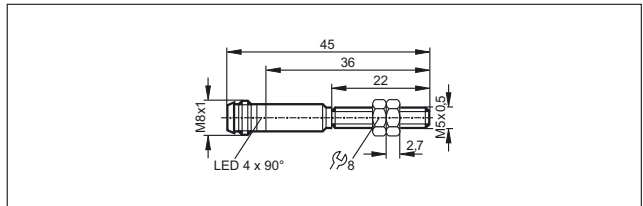

80

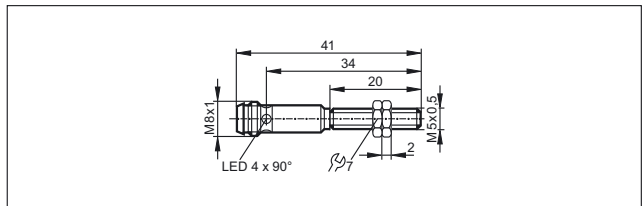

81

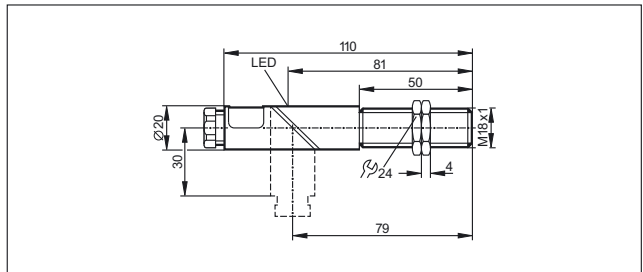

82

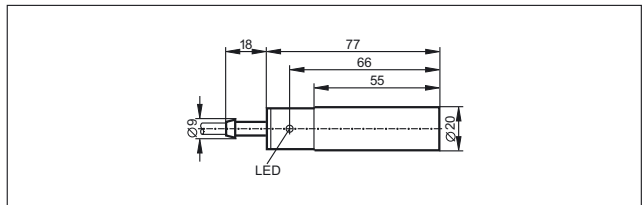

83

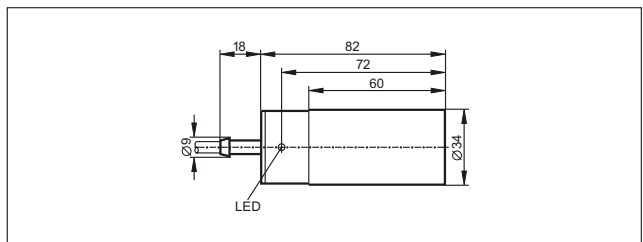

84

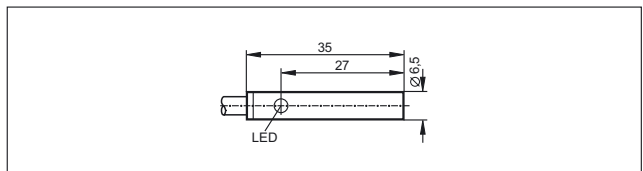

85

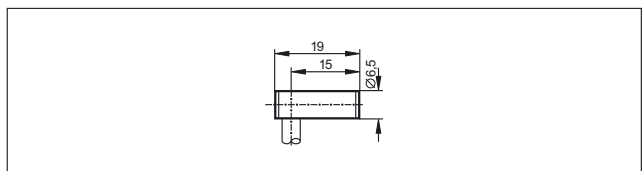



Position sensors

Scale drawings / drawing no. – CAD download: www.ifm.com

86

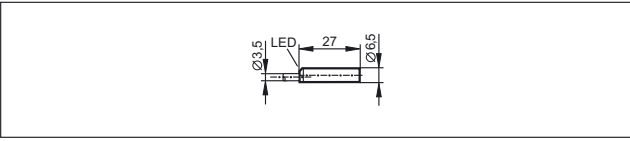

87

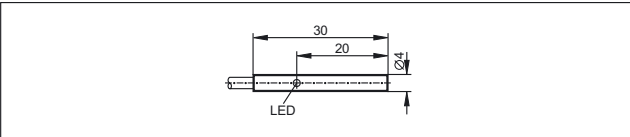

88

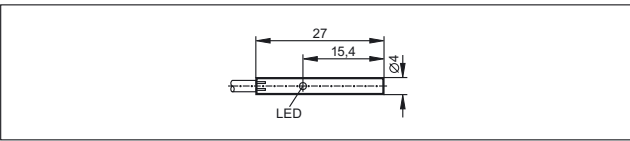

89

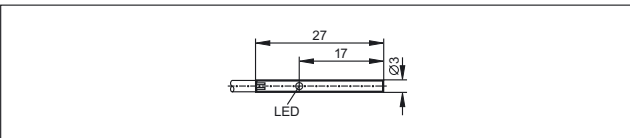

90

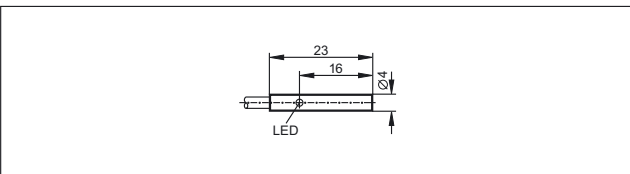

91

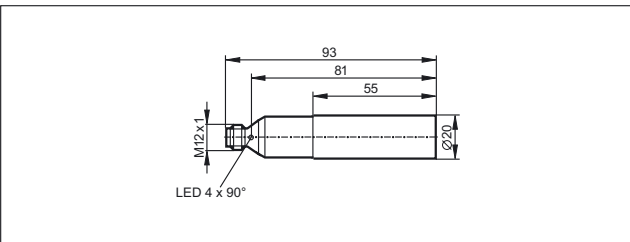

92

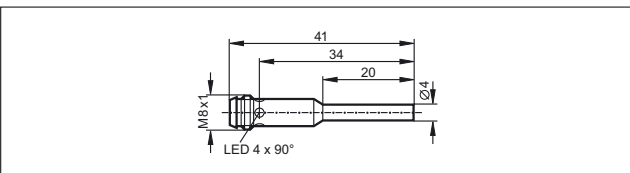

93

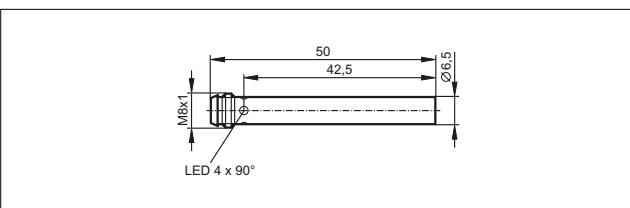

94

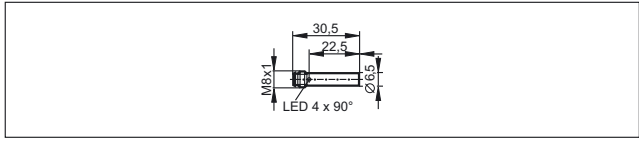

95

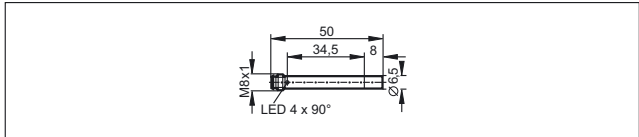

96

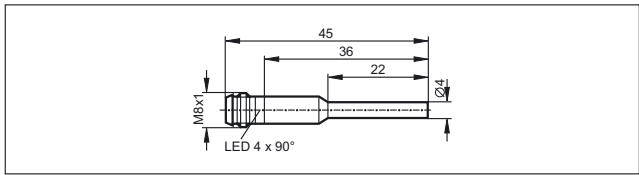

97

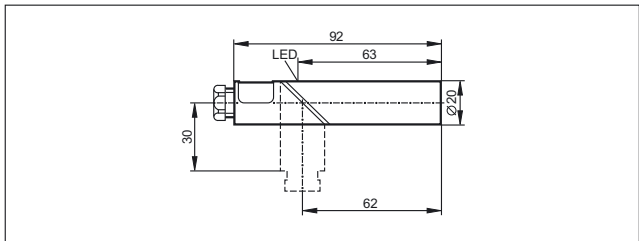

98

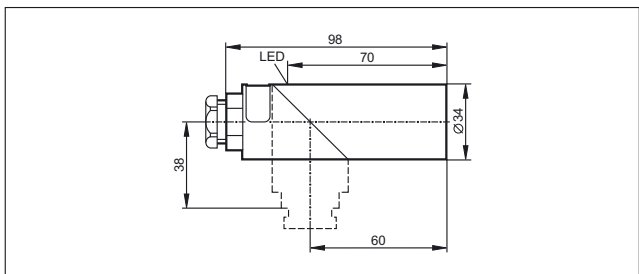

99

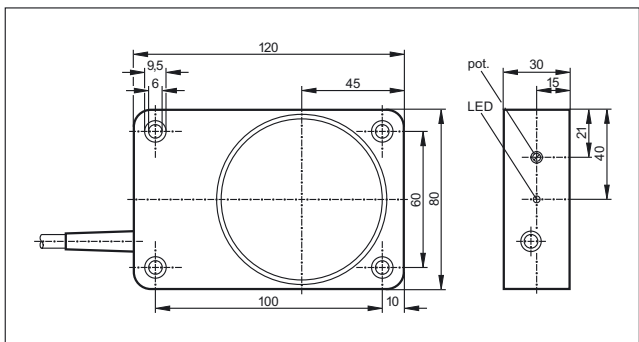

Scale drawings / drawing no. – CAD download: www.ifm.com

100

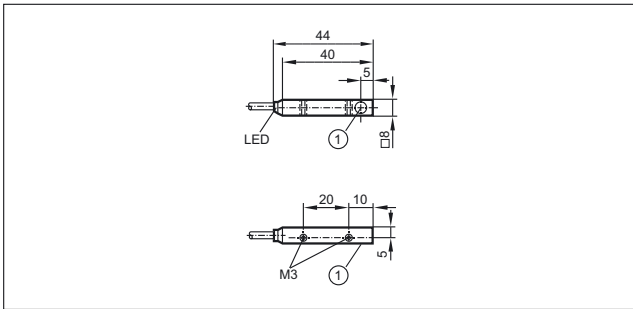

1: sensing face

101

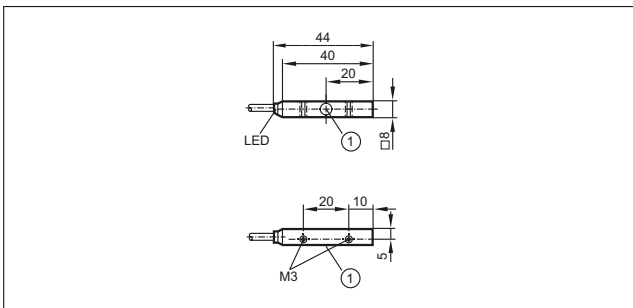

1: sensing face

102

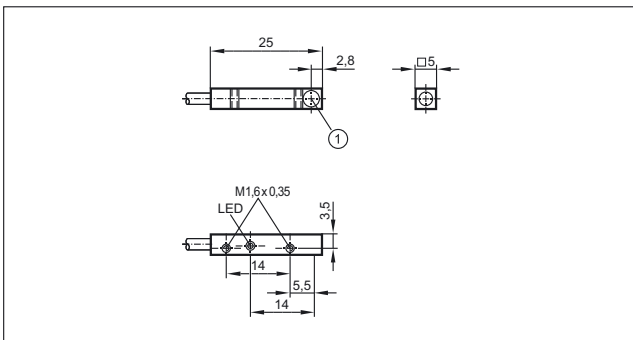

1: sensing face

103

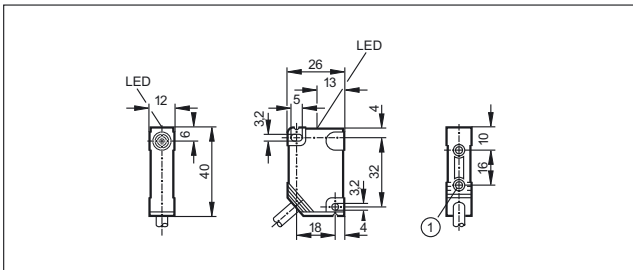

1: threaded insert M3, depth 5.8 mm, max. tightening torque 1.2 Nm (screw fixing class 8.8) when brass insert in contact with counterpart.

104

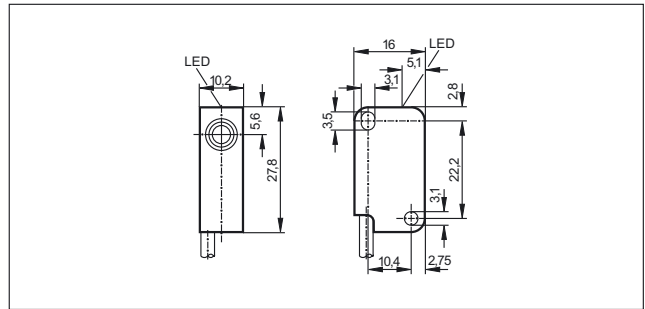

105

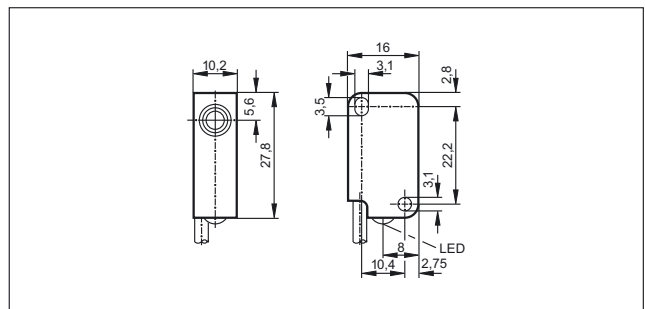

106

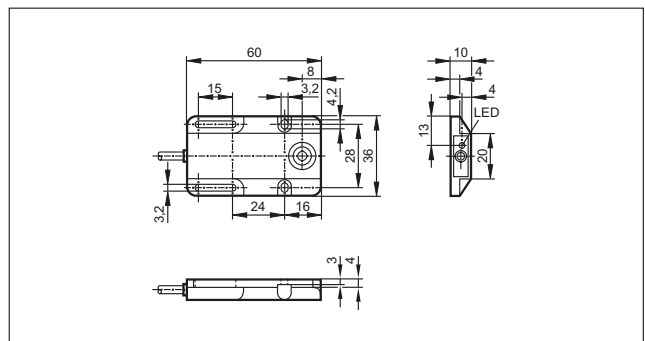

107

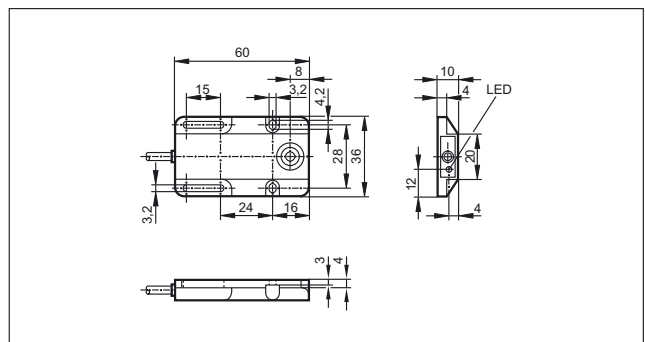



Position sensors

Scale drawings / drawing no. – CAD download: www.ifm.com

108

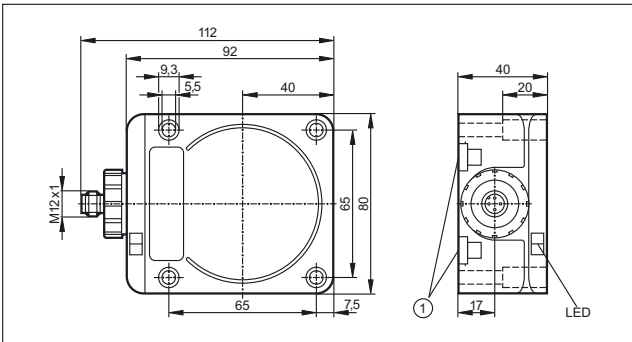

1: Mounting on DIN rail

109

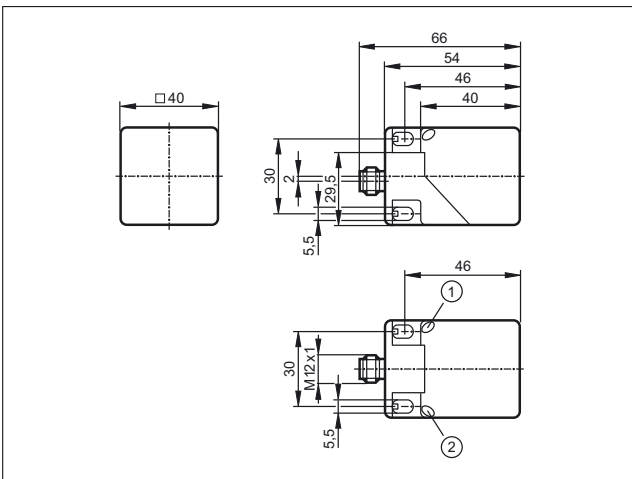

1: LED yellow, 2: LED green

110

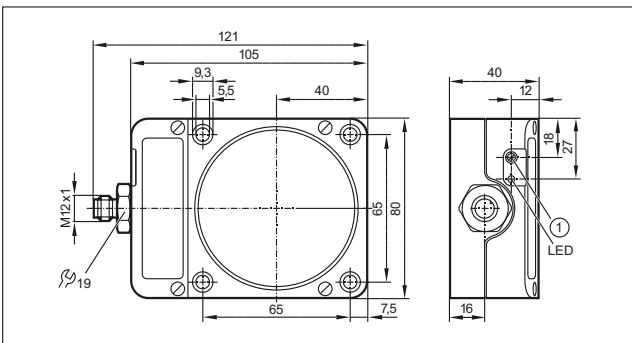

111

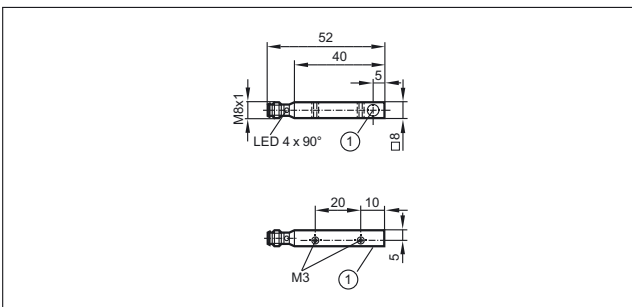

1: sensing face

112

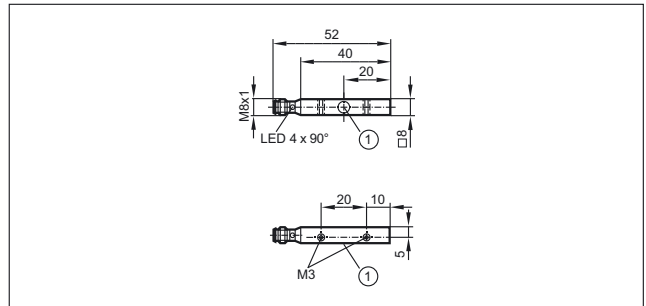

1: sensing face

113

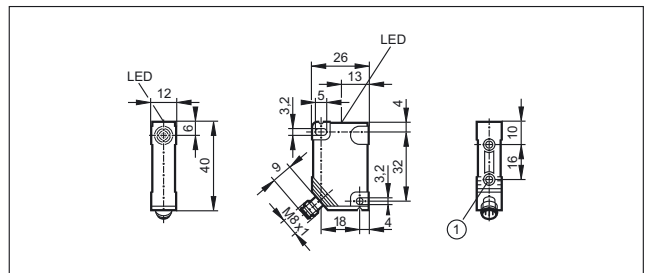

1: threaded insert M3, depth 5.8 mm, max. tightening torque 1.2 Nm (screw fixing class 8.8) when brass insert in contact with counterpart.

114

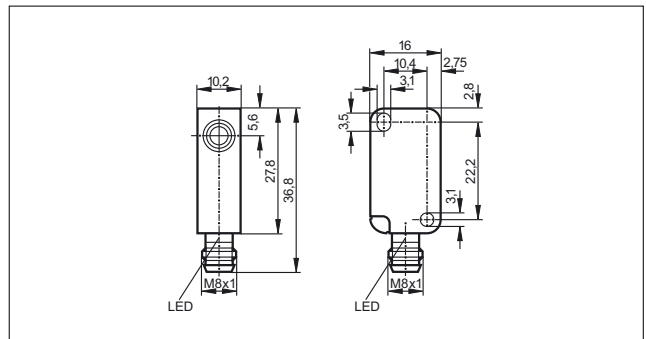

115

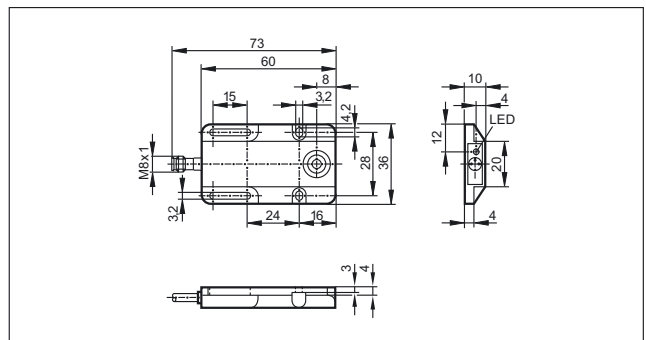

Scale drawings / drawing no. – CAD download: www.ifm.com

116

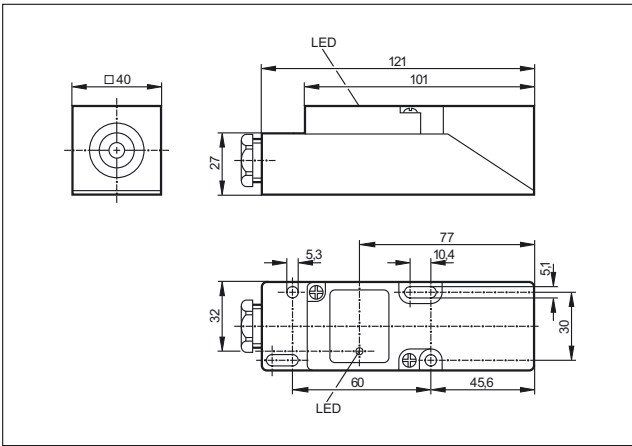

120

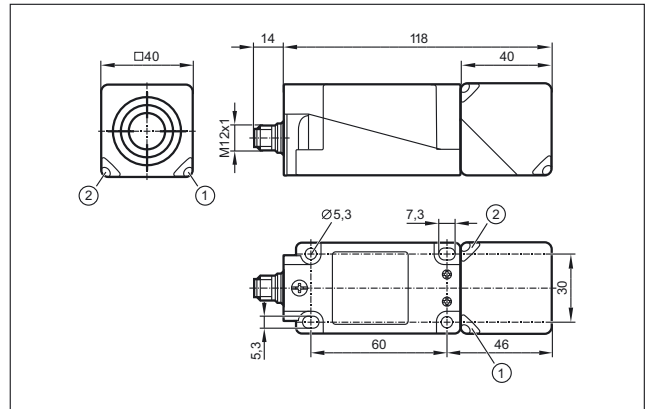

1: LED green, 2: LED yellow

117

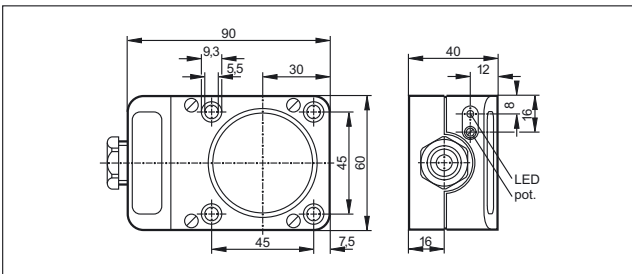

118

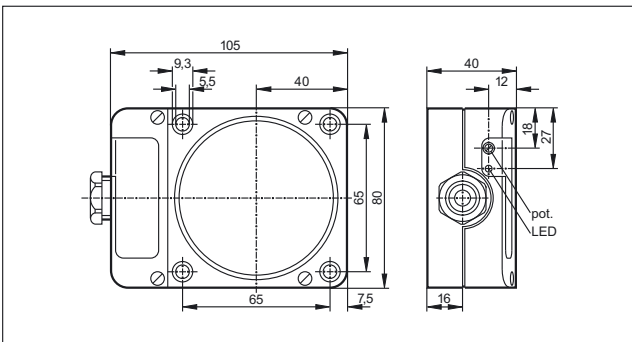

119

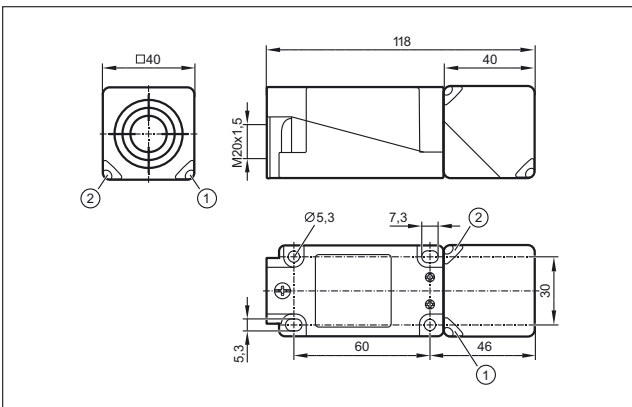

1: LED green, 2: LED yellow

121

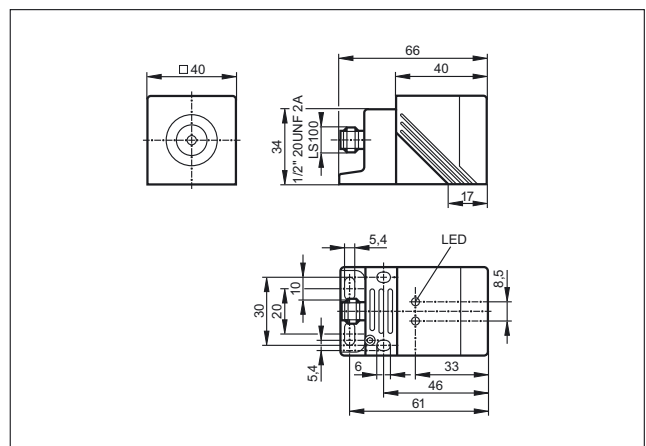

122

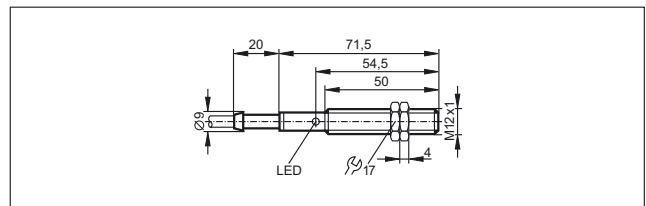

123

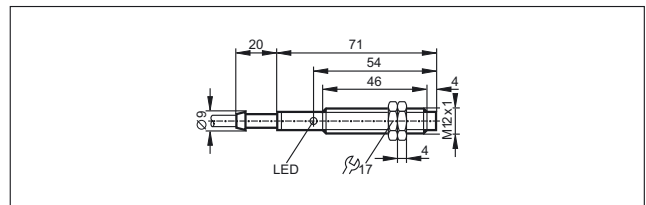



Position sensors

Scale drawings / drawing no. – CAD download: www.ifm.com

124

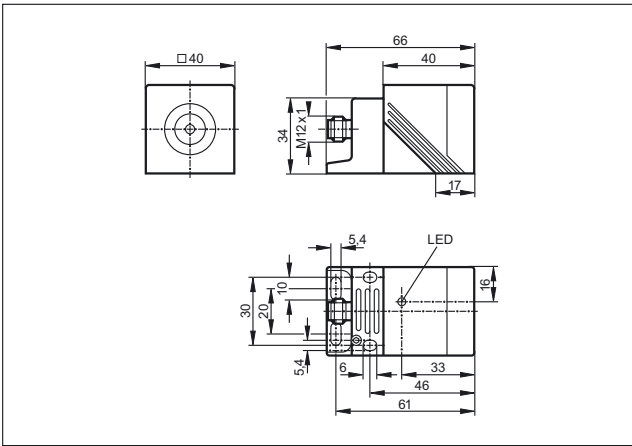

130

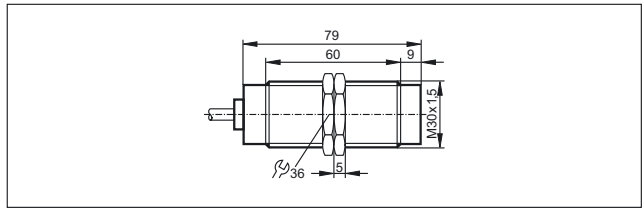

131

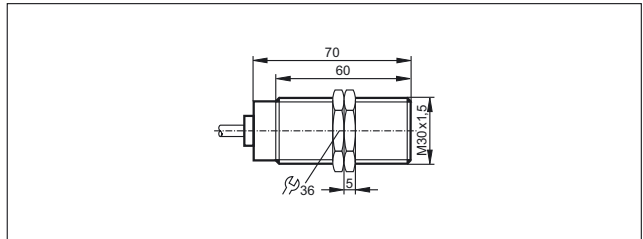

125

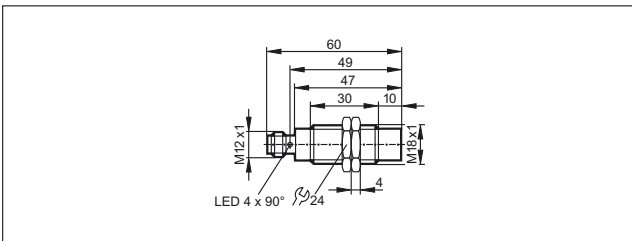

132

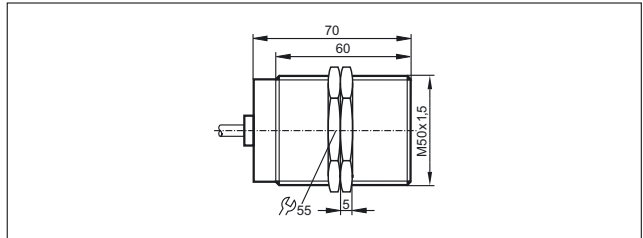

126

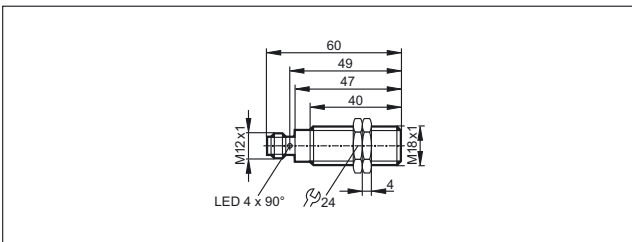

133

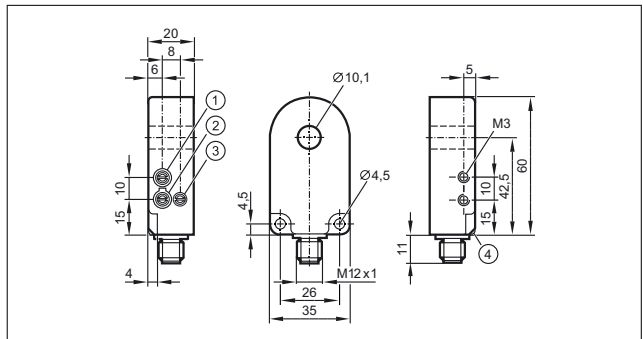

127

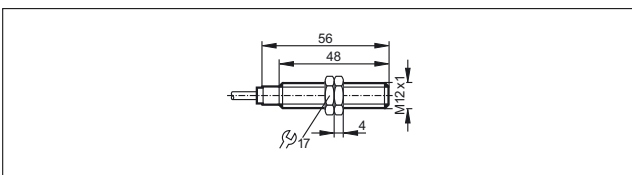

134

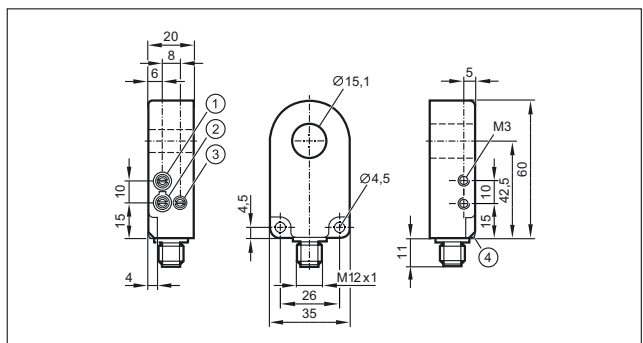

128

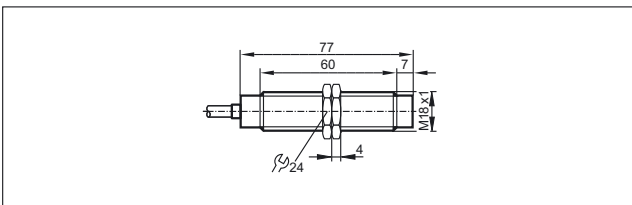

129

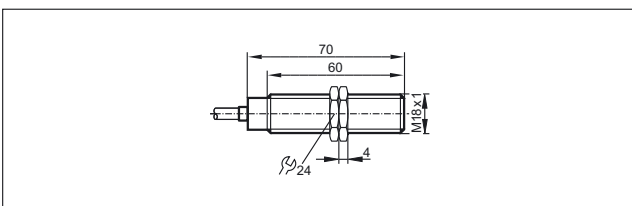

Scale drawings / drawing no. – CAD download: www.ifm.com

135

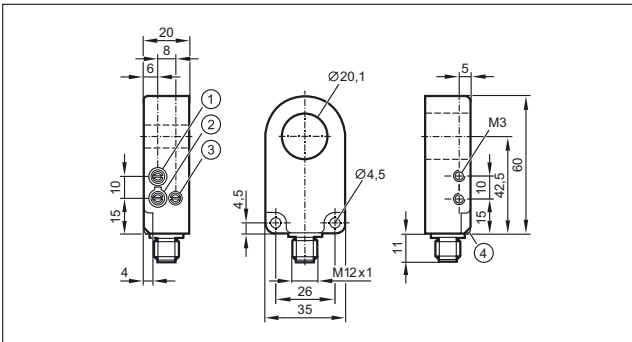

136

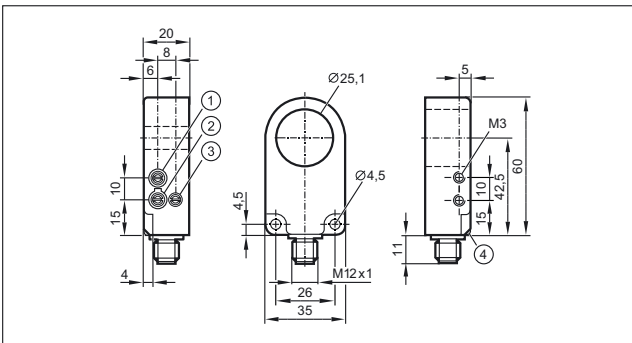

137

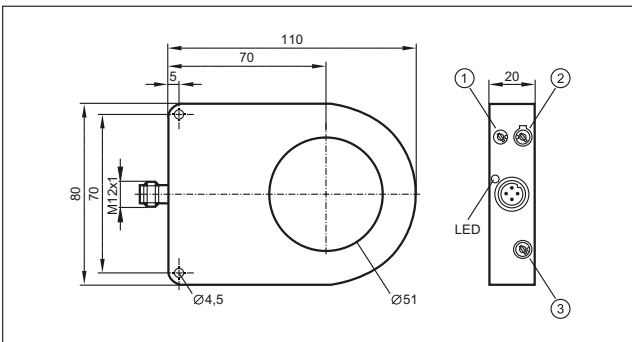

138

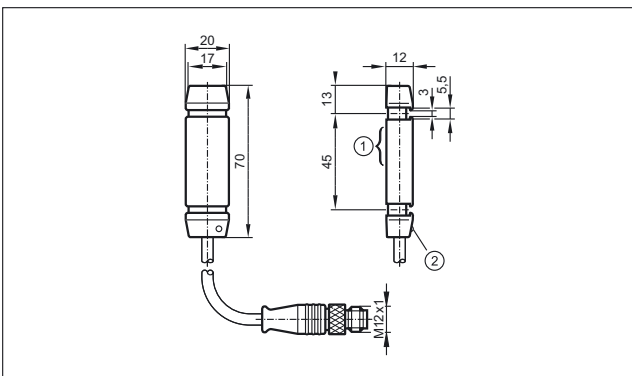

1: sensing face, 2: LED operating status

139

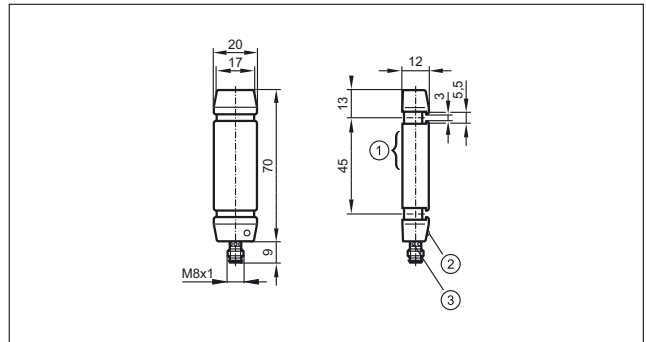

1: sensing face, 2: LED operating status, 3: LED switching status

140

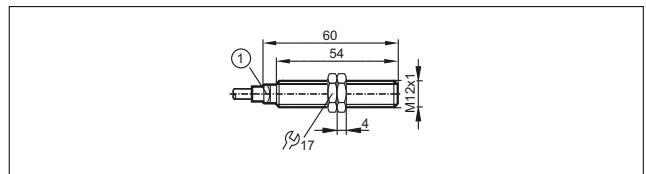

1: LED (yellow)

141

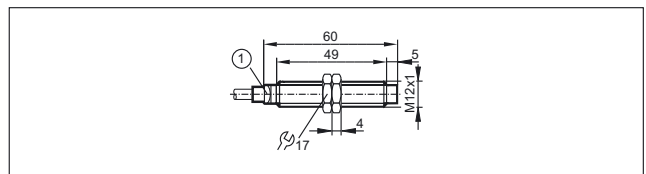

1: LED (yellow)

142

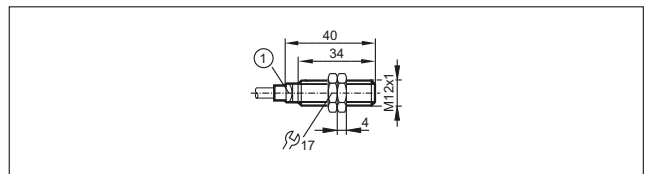

1: LED (yellow)

143

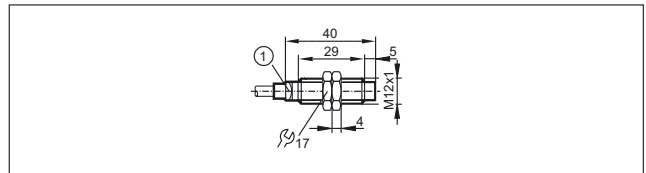

1: LED (yellow)

144

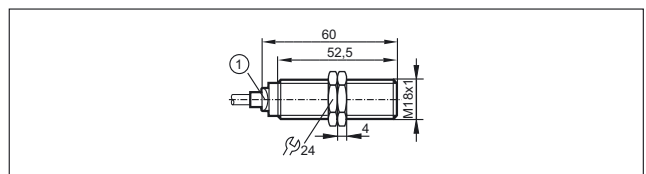

1: LED (yellow)



Position sensors

Scale drawings / drawing no. – CAD download: www.ifm.com

145

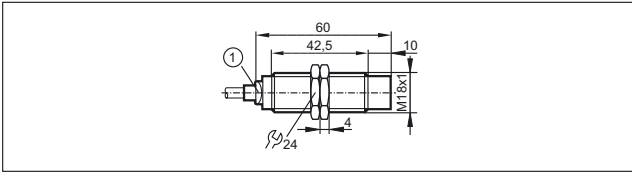

1: LED (yellow)

146

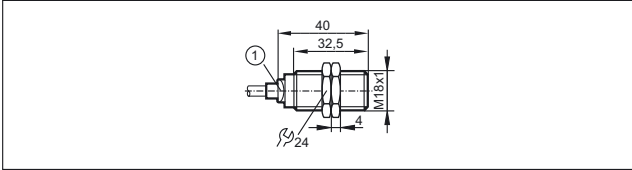

1: LED (yellow)

147

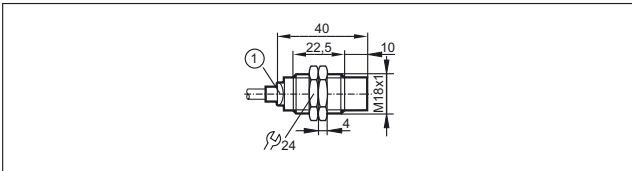

1: LED (yellow)

148

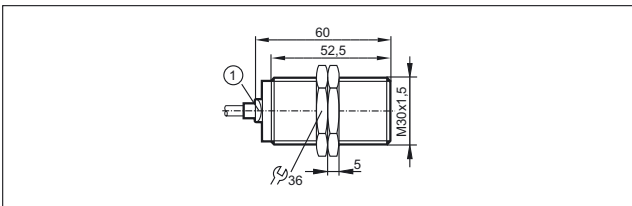

1: LED (yellow)

149

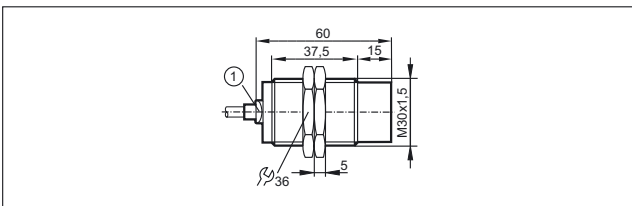

1: LED (yellow)

150

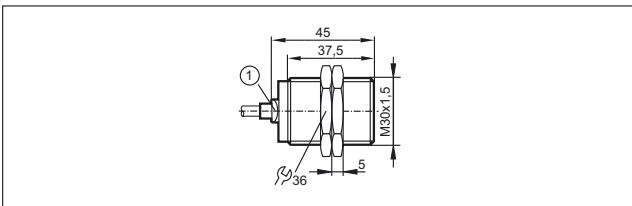

1: LED (yellow)

151

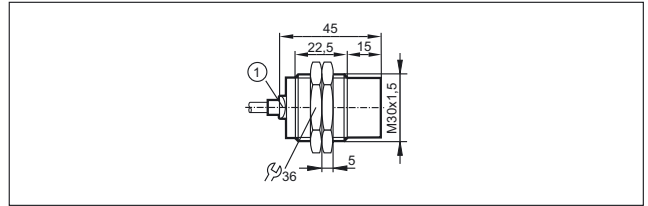

1: LED (yellow)

152

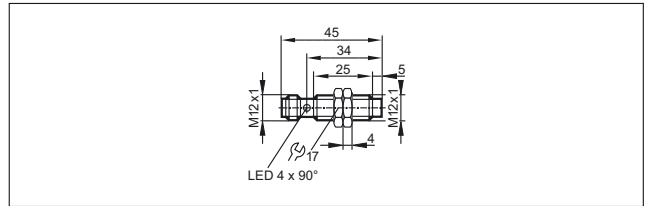

153

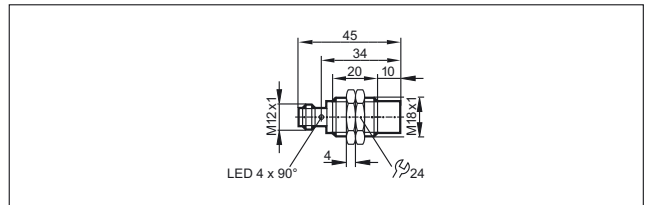

154

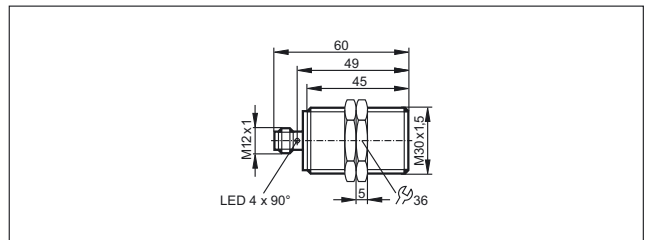

155

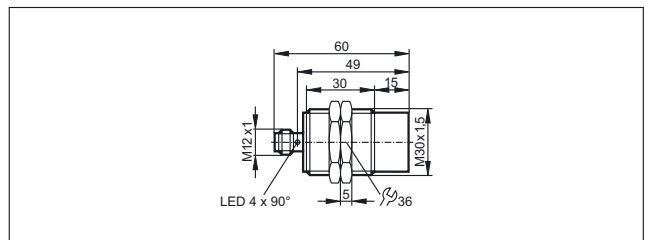

156

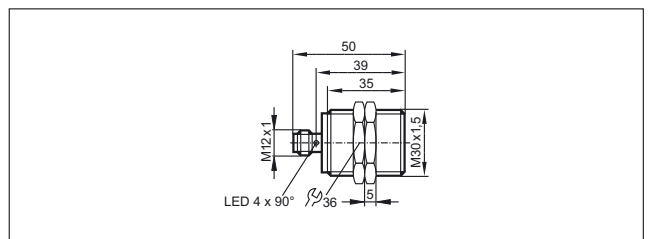

Scale drawings / drawing no. – CAD download: www.ifm.com

157

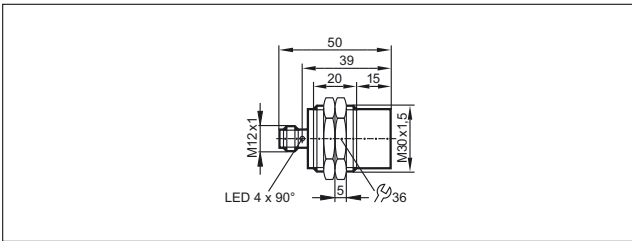

163

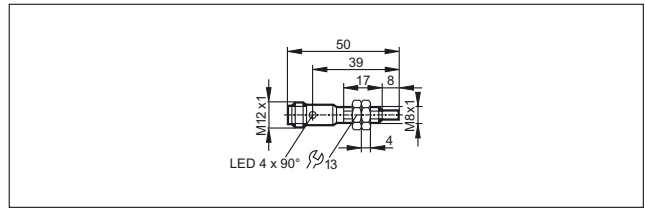

158

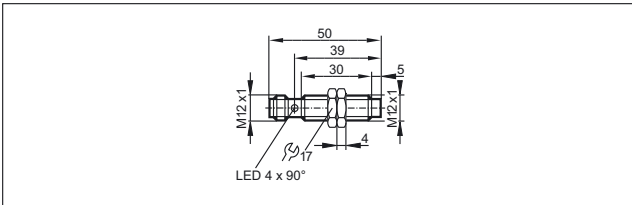

164

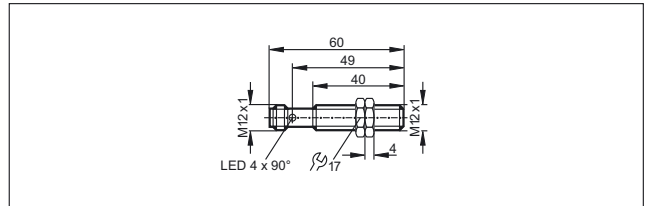

159

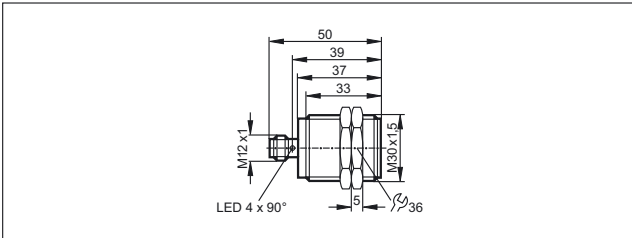

165

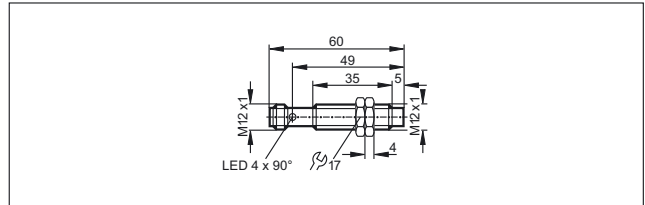

160

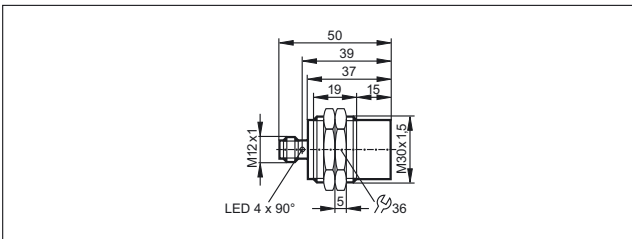

166

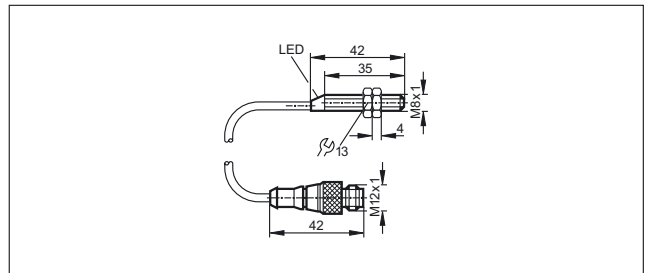

161

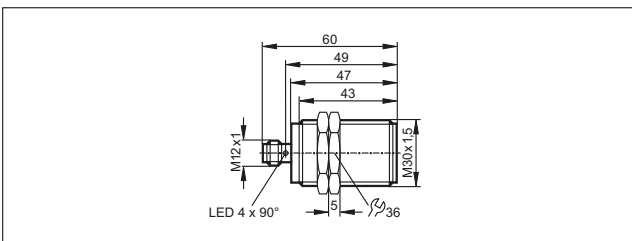

167

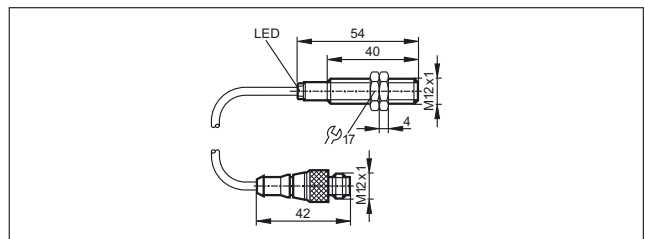

162

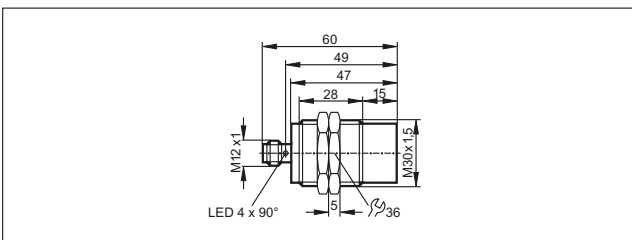

168

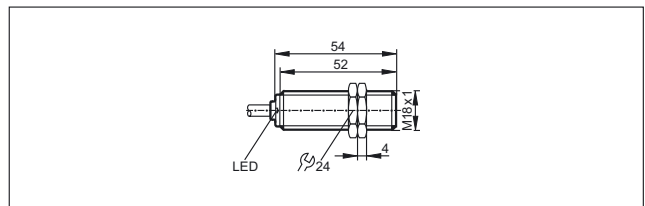

169

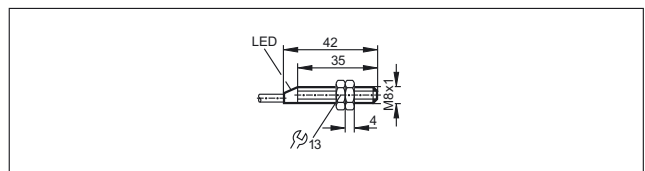



Position sensors

Scale drawings / drawing no. – CAD download: www.ifm.com

170

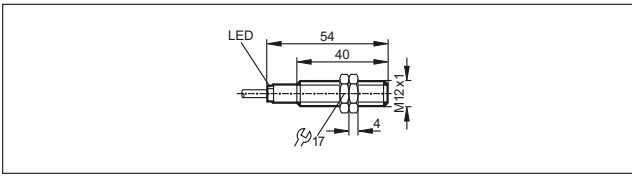

171

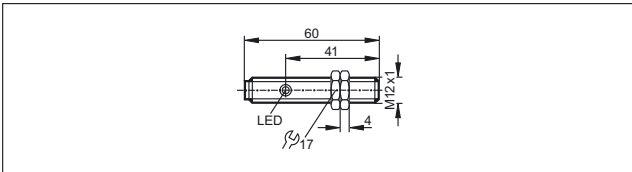

172

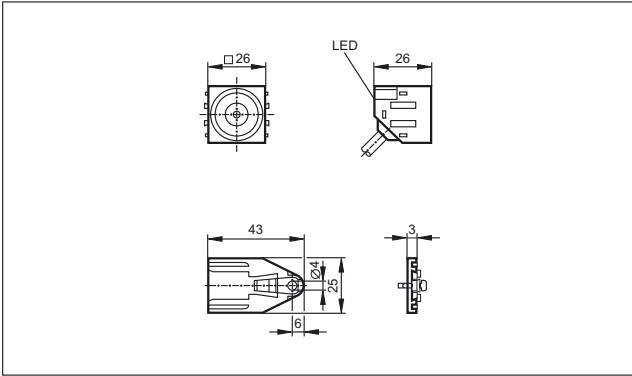

173

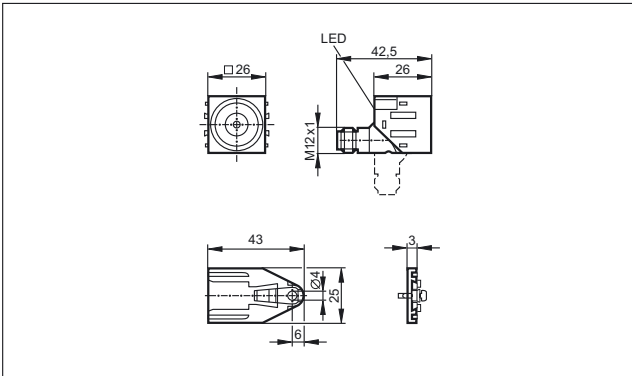

174

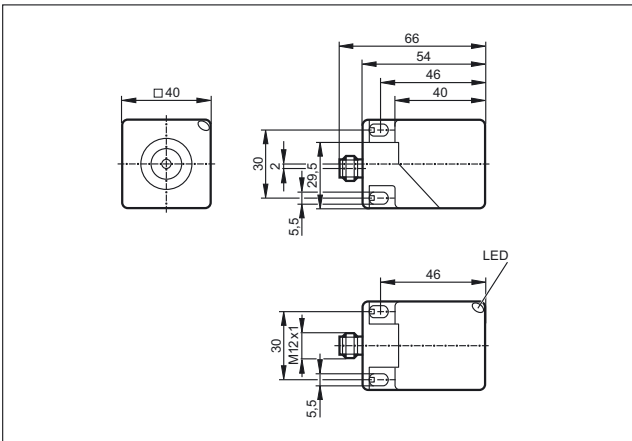

175

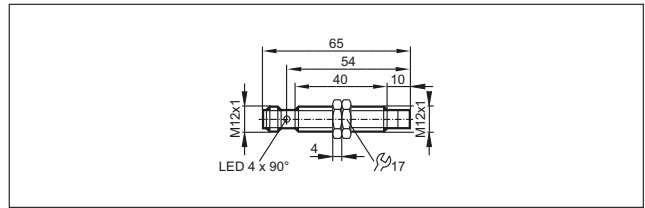

176

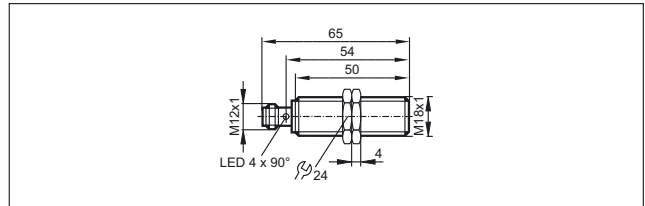

177

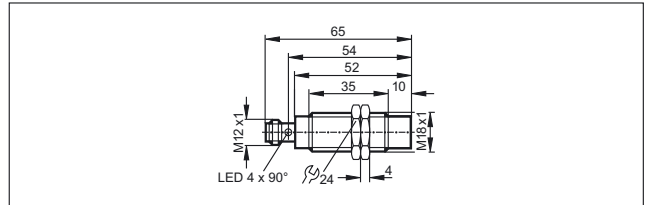

178

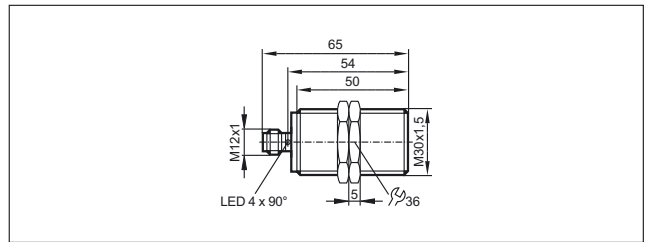

179

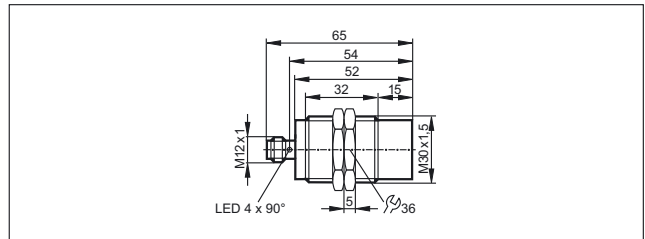

180

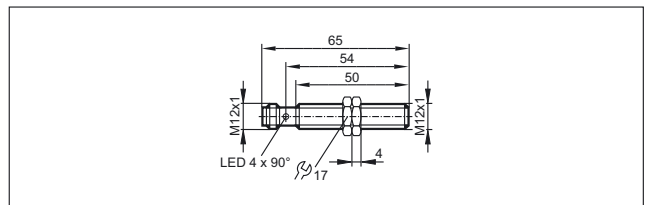

181

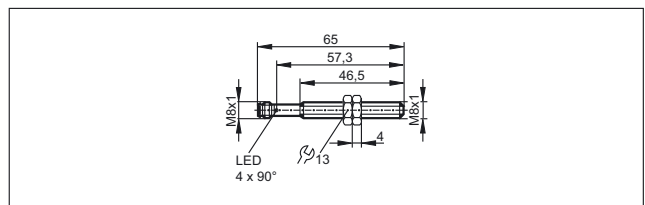

Scale drawings / drawing no. – CAD download: www.ifm.com

182

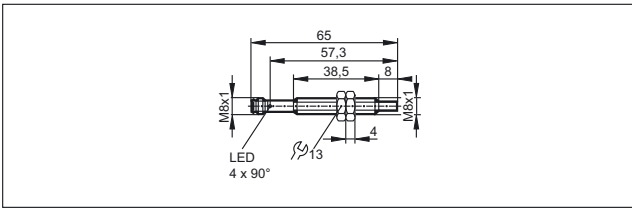

183

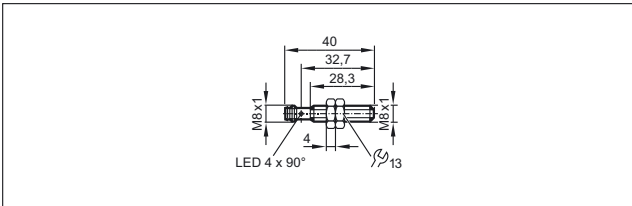

184

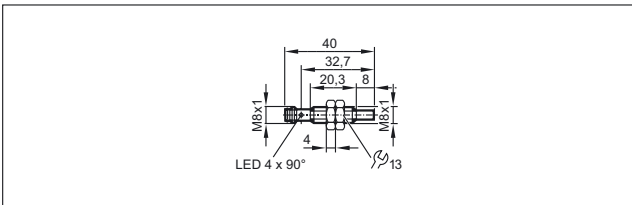

185

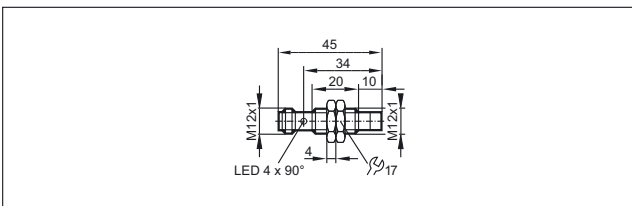

186

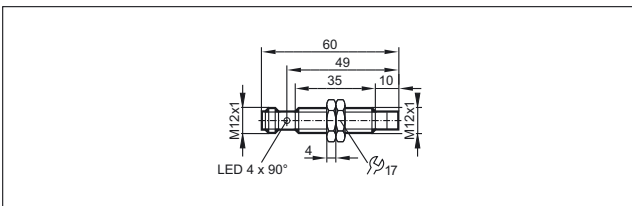

187

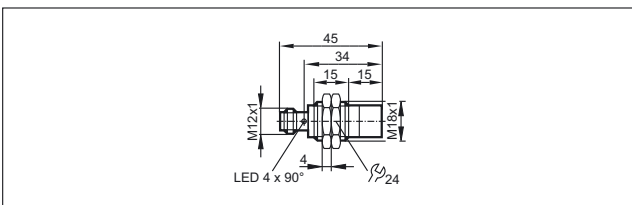

188

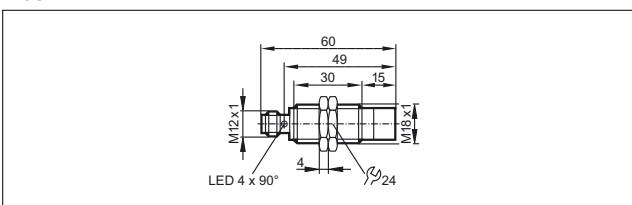

189

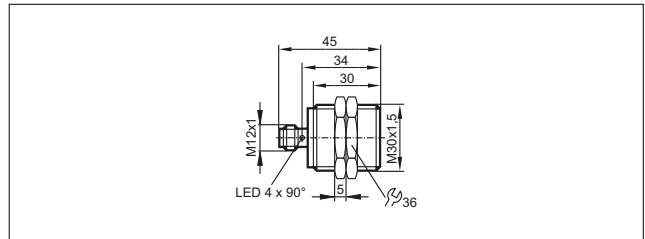

190

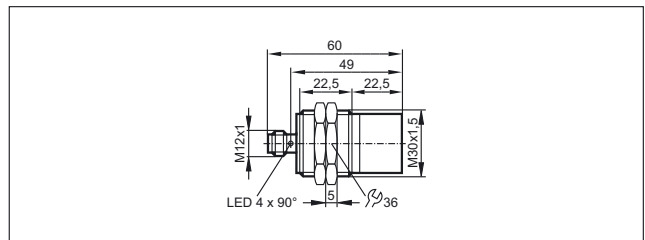

191

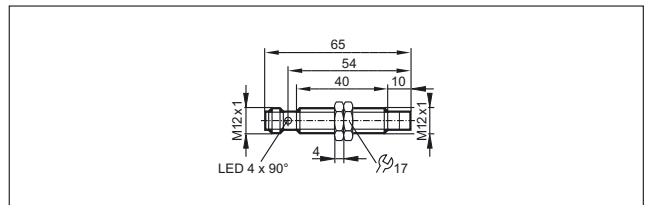

192

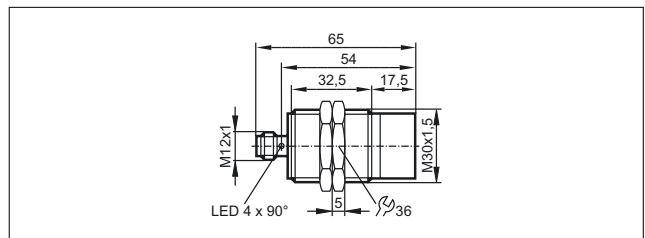

193

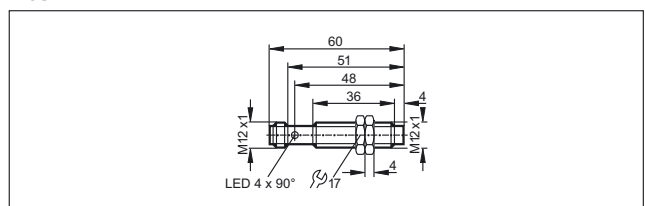

194

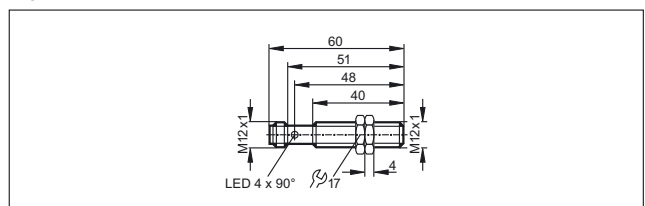



Position sensors

Scale drawings / drawing no. – CAD download: www.ifm.com

195

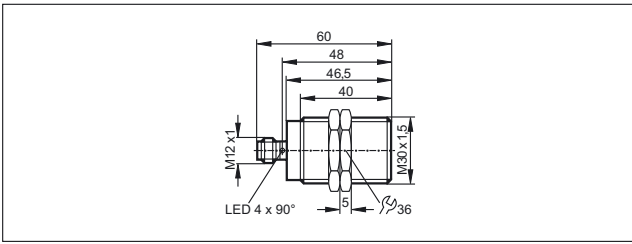

196

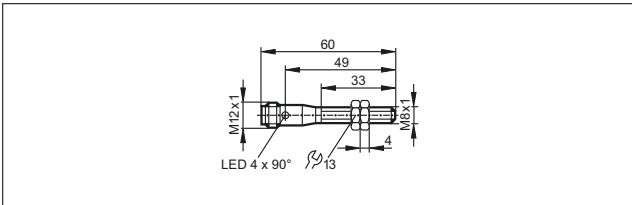

197

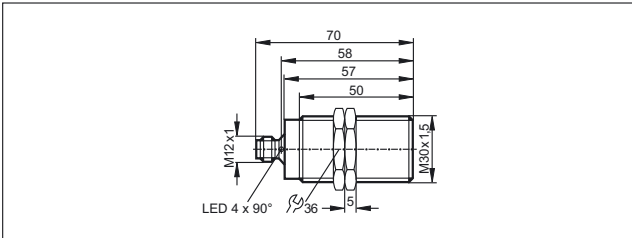

198

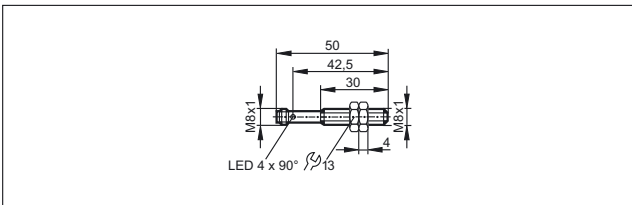

199

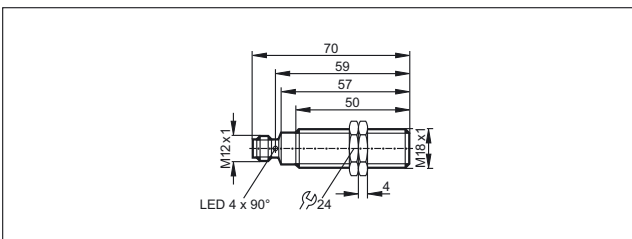

200

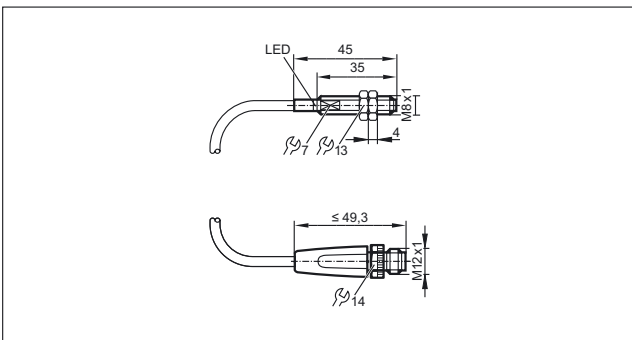

201

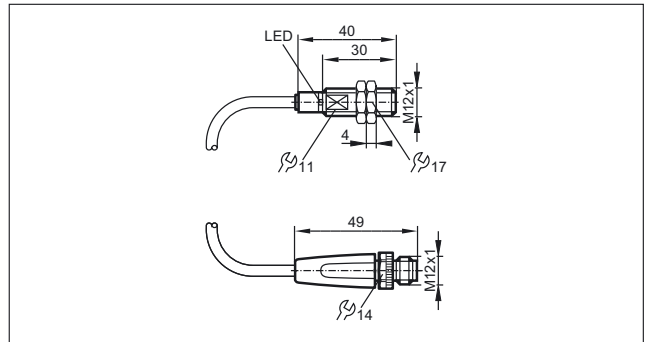

202

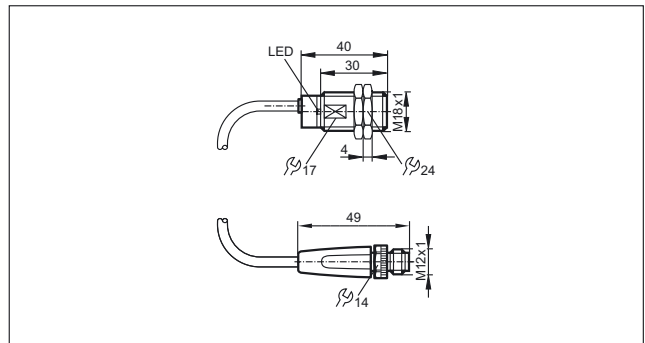

203

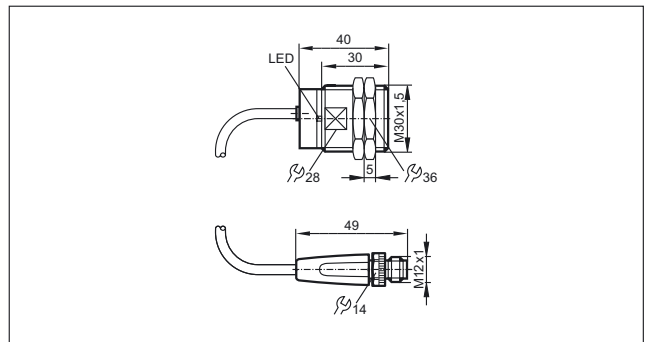

204

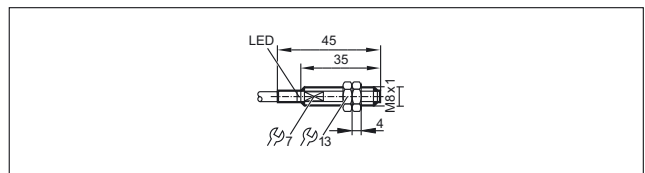

205

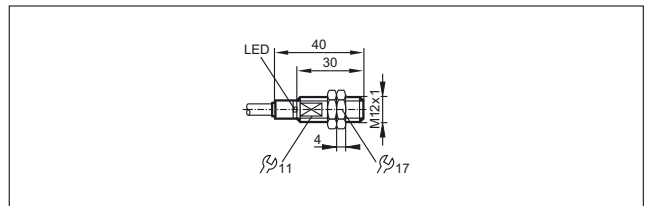

206

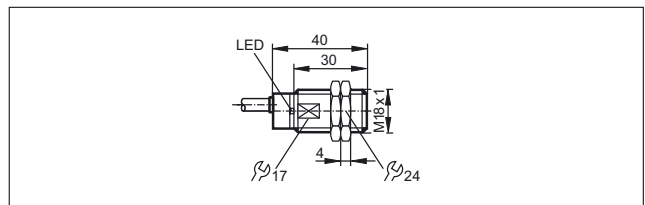

Scale drawings / drawing no. – CAD download: www.ifm.com

207

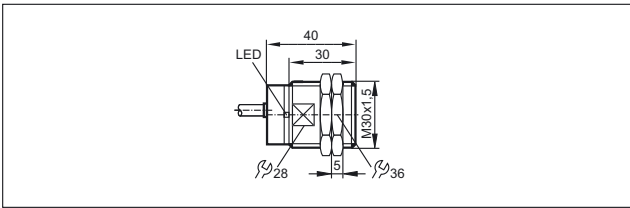

213

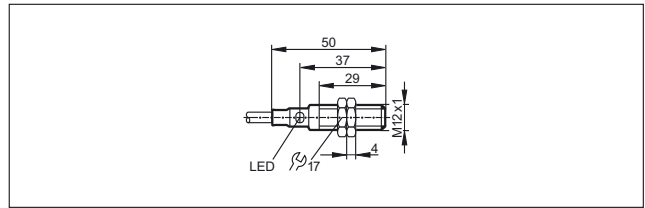

208

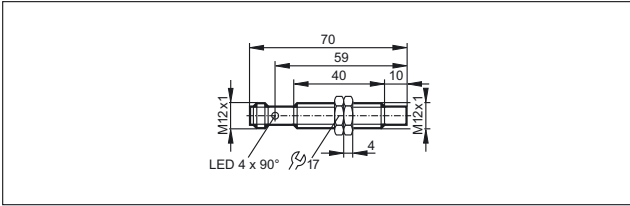

214

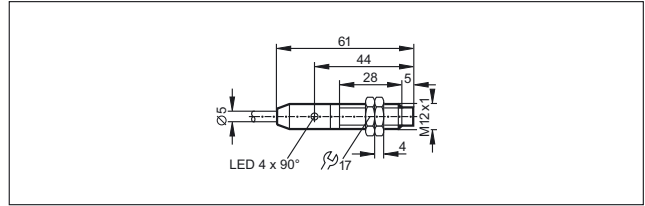

209

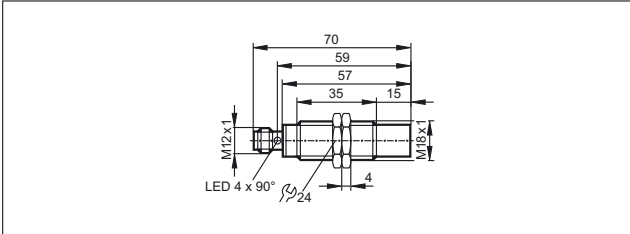

215

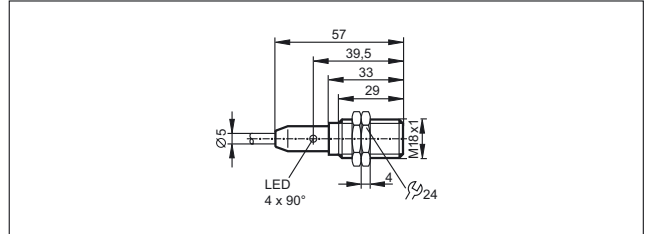

210

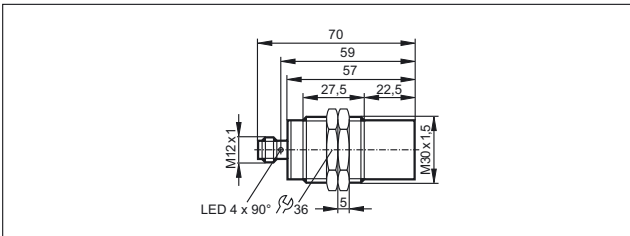

216

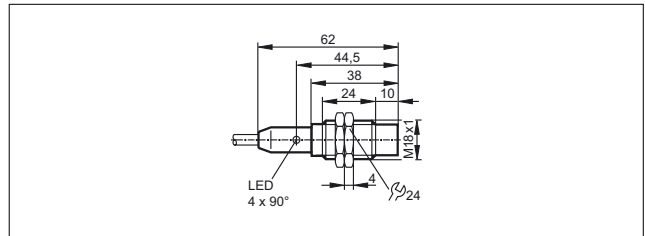

211

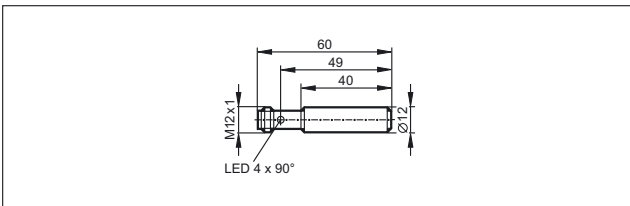

217

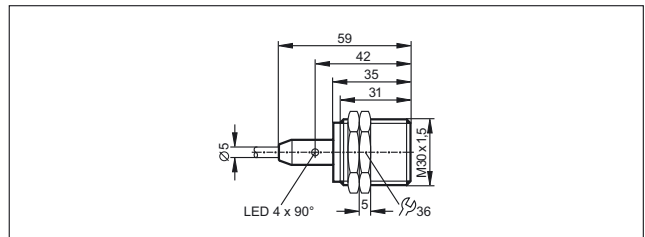

212

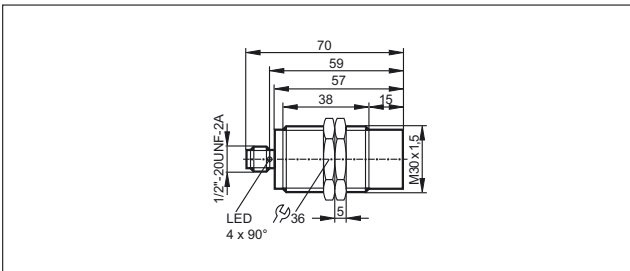

218

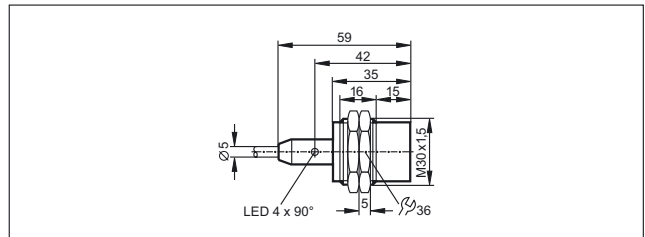



Position sensors

Scale drawings / drawing no. – CAD download: www.ifm.com

219

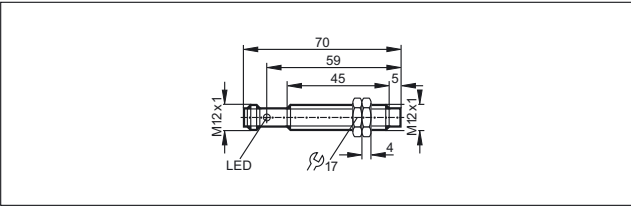

225

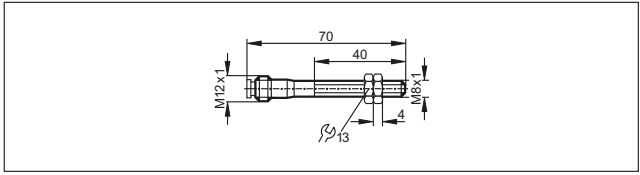

220

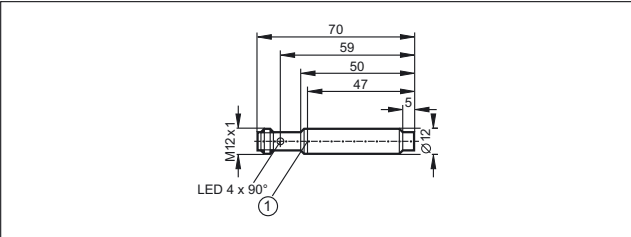

1: locating groove

226

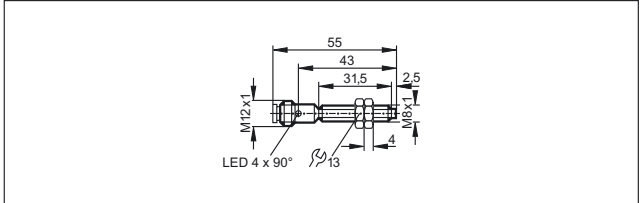

221

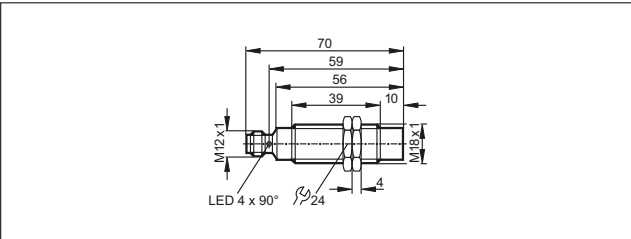

227

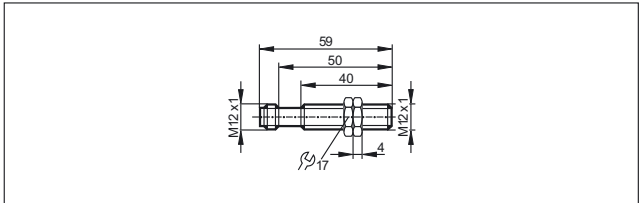

228

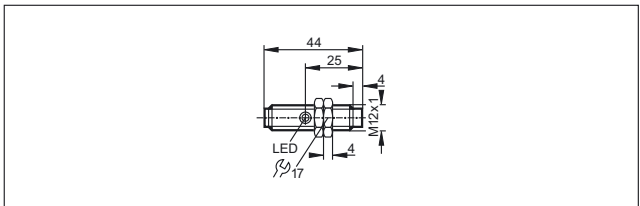

222

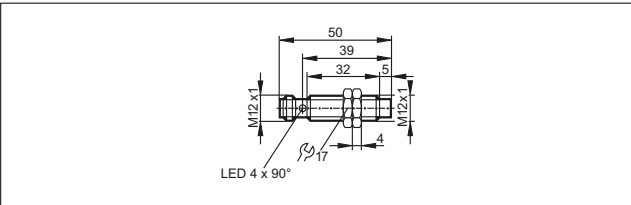

229

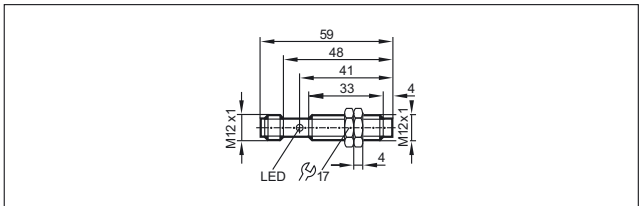

223

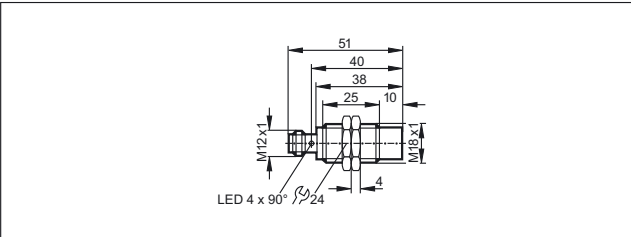

230

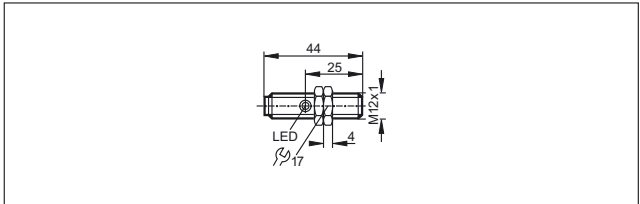

224

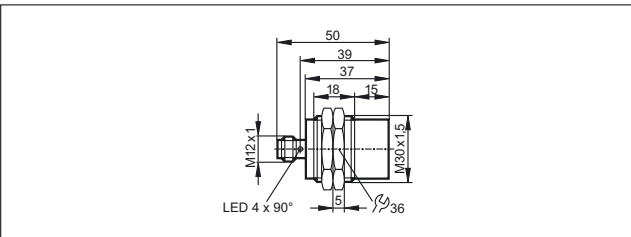

231

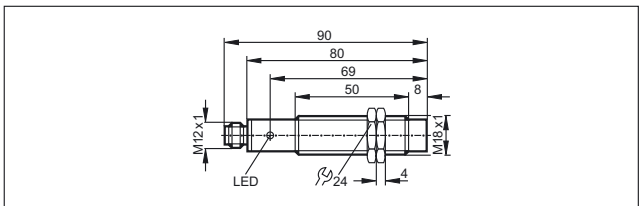

Scale drawings / drawing no. – CAD download: www.ifm.com

232

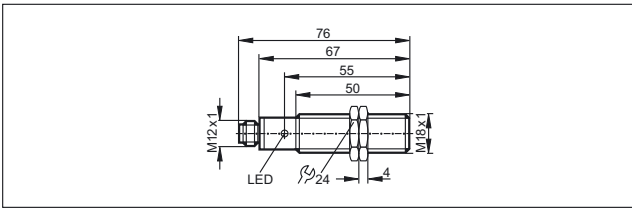

233

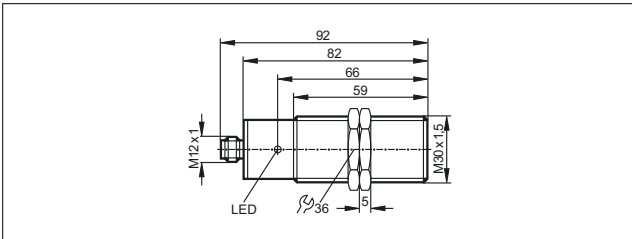

234

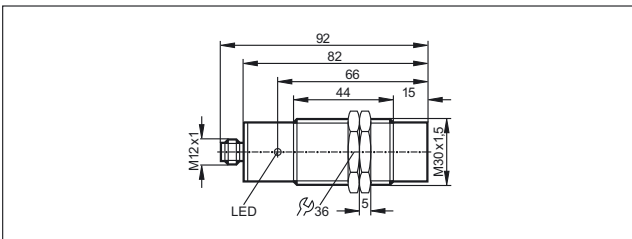

235

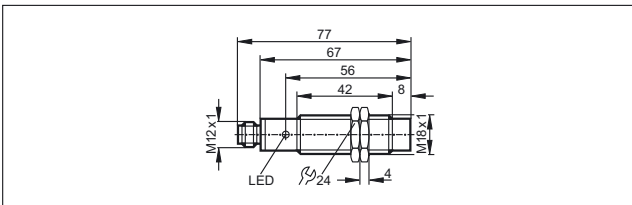

236

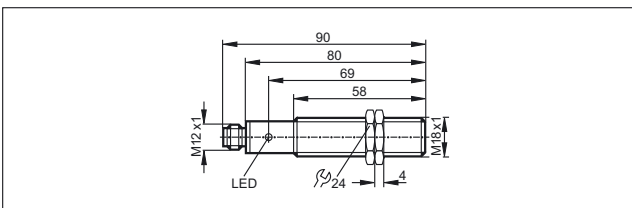

237

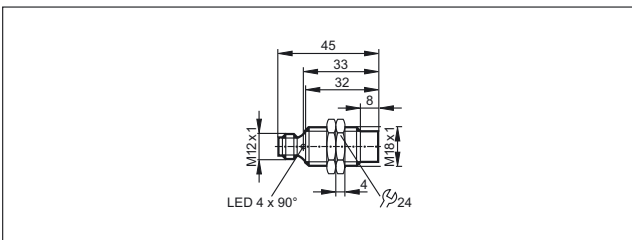

238

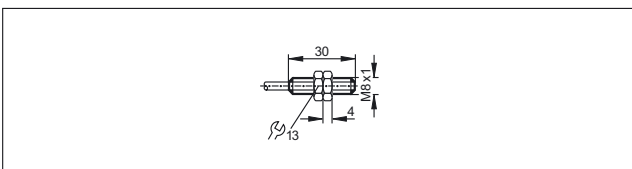

239

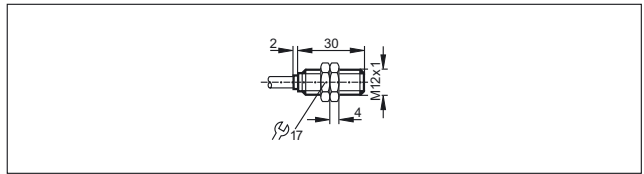

240

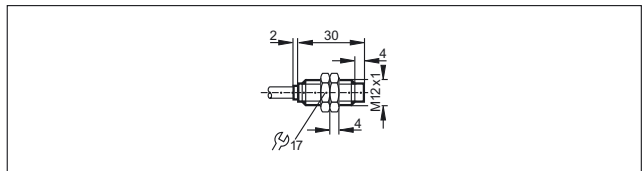

241

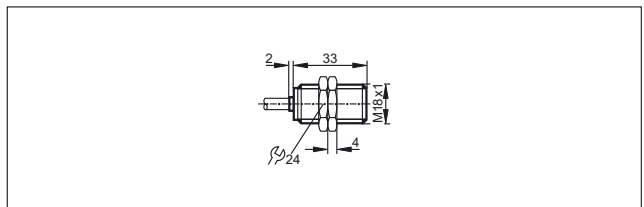

242

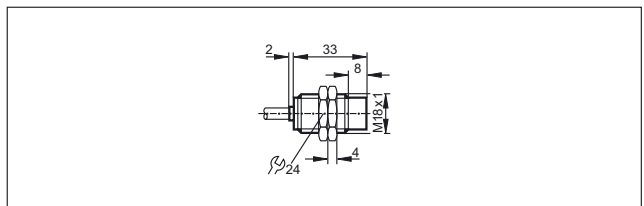

243

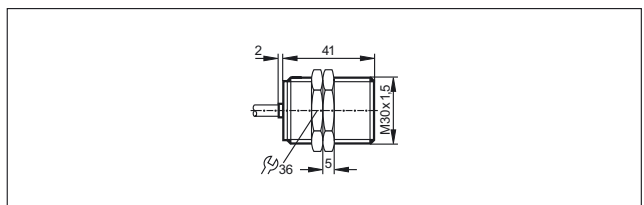

244

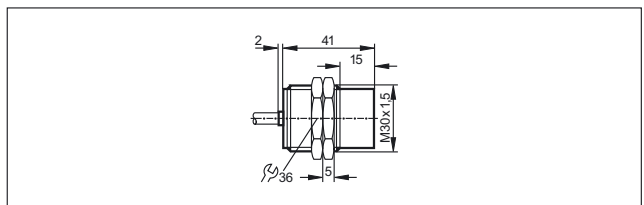

245

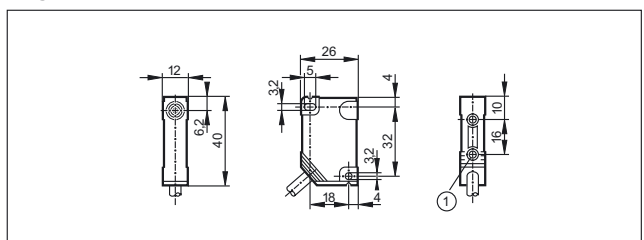

1: threaded insert M3, depth 5.8 mm, max. tightening torque 1.2 Nm (screw fixing class 8.8) when brass insert in contact with counterpart.



Position sensors

Scale drawings / drawing no. – CAD download: www.ifm.com

246

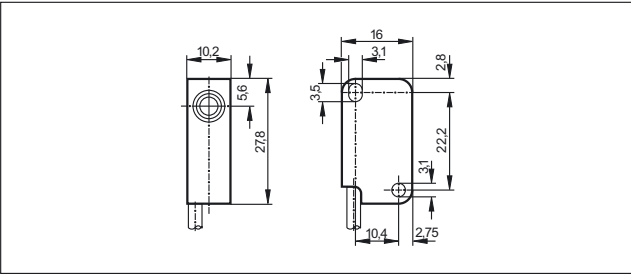

247

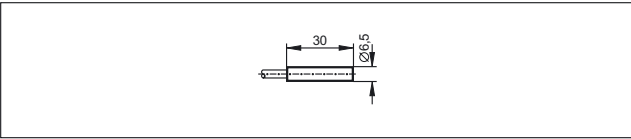

248

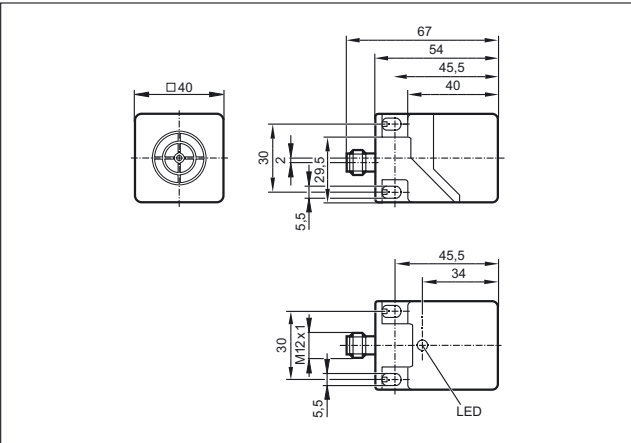

249

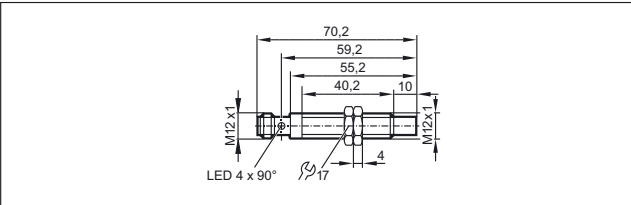

250

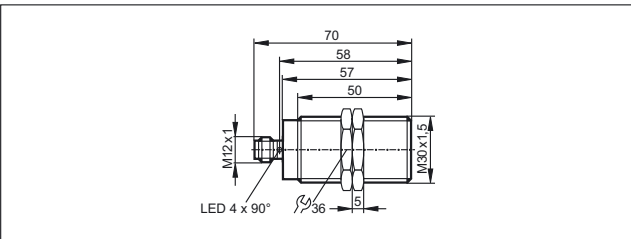

251

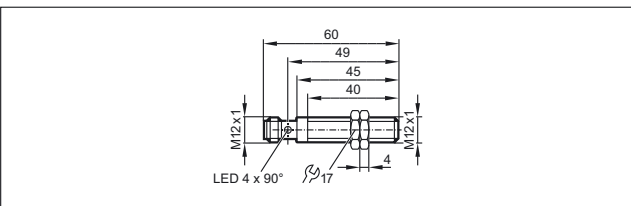

252

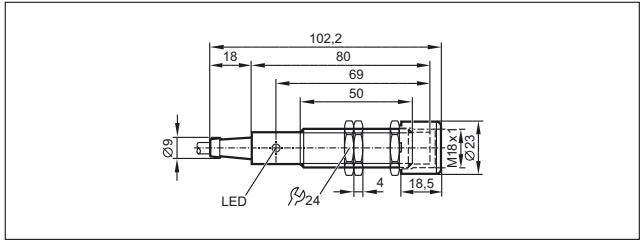

253

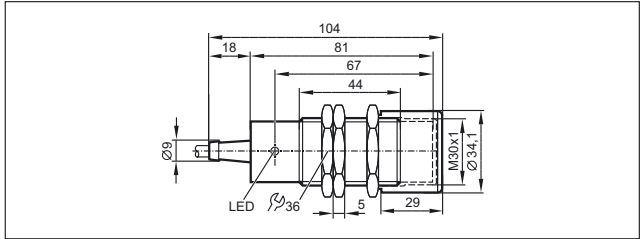

1: Sensor, 2: Sensor with protective cover

254

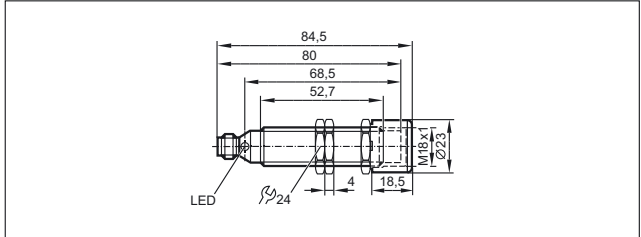

255

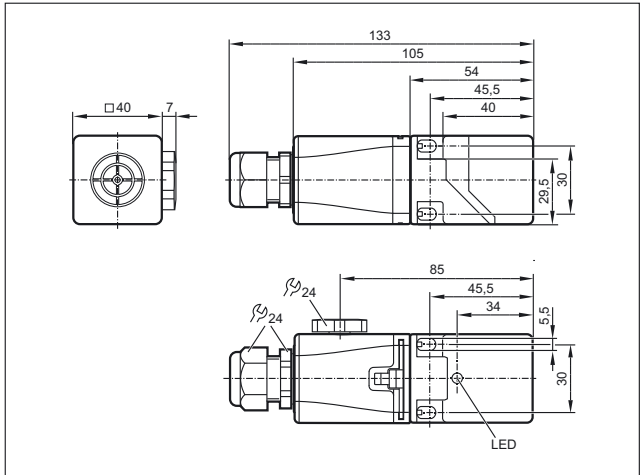

256

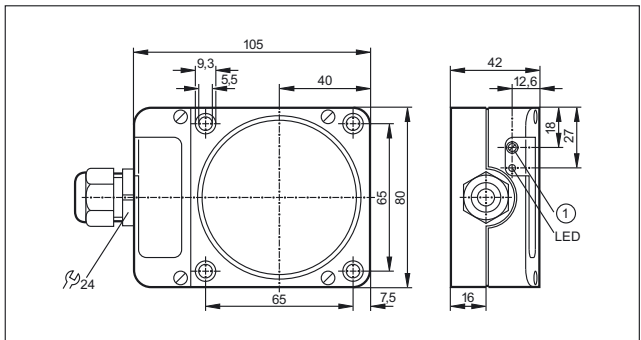

1: potentiometer





Capacitive sensors ensure accurate detection of positions and levels



Capacitive sensors



Easy parameter setting via IO-Link before installation of the sensor

Versatile data processing via IO-Link

Plastic or metal housings for different applications

Sensors for position and level detection

Mounting accessories for installation on tanks or sight glasses (bypass)



IO-Link



IP 69 K



Medium temperature up to 110°C



Capacitive sensors

Capacitive sensors are used for non-contact detection of any types of objects and for level monitoring. In contrast to inductive sensors, which only detect metallic objects, capacitive sensors can also detect non-metallic materials.

IO-Link for more convenience

IO-Link allows direct detection of the process value or switch-on/switch-off delays of the output. The parameters are set via the IO-Link interface.

Capacitive touch sensors

Capacitive touch sensors are wear and maintenance-free since switching does not require any pressure. Their operating principle is dynamic, static or latching. They are typically used as start / stop buttons or enable switches.

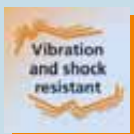

Vibration and shock resistant



Temperature range -40...+85°C

System overview	Page
Sensors for level and position detection DC	162 - 163
Sensors for level and position detection AC/DC	163 - 164
Sensors with IO-Link	164 - 167
Sensors with ATEX approval	167 - 168
Switching amplifiers with ATEX approval	168 - 169
Dynamic capacitive touch sensors	169
Static capacitive touch sensors	170
Capacitive touch sensors with latching evaluation principle	170
Software	171
Accessories	171 - 172
Accessories mounting adapters	172
Accessories mounting components	172 - 173
Wiring diagrams	173 - 174
Scale drawings / drawing no. – CAD download: www.ifm.com	174 - 178







Position sensors



Sensors for level and position detection DC

Type	Dimensions [mm]	Sensing range [mm]	Material	U _b [V]	Protection	f [Hz]	I _{load} [mA]	Draw- ing no.	Order no.
Cable 2 m · Output function  · DC PNP · Wiring diagram no. 1									
	M12 / L = 69	4 f	high-grade stainless steel	10...36	IP 65	50	100	1	KF5014
	M12 / L = 70	8 nf	high-grade stainless steel	10...36	IP 65	50	100	2	KF5015
Cable 2 m · Output function  · DC PNP · Wiring diagram no. 2									
	M18 / L = 77	8 nf	PP	10...36	IP 65 / IP 67	10	200	3	KG5069
M12 connector · Output function  · DC PNP · Wiring diagram no. 19 · Connector groups 8, 10, 19, 21, 23, 25, 148, 149, 153, 184, 188, 193, 202									
	M30 / L = 116	nf	PPS	10...30	IP 67	10	200	4	KN5121
M12 connector · Output function  · DC PNP · Wiring diagram no. 3 · Connector groups 8, 10, 11, 18, 19, 21, 23, 25, 148, 149, 150, 153, 154, 184, 188, 190, 193, 202, 203, 204									
	M18 / L = 87	12 nf	PBT	10...36	IP 65 / IP 67	10	200	5	KG5066
	M18 / L = 87	8 nf	PBT	10...36	IP 65 / IP 67	10	200	5	KG5071
	M30 / L = 90	20 nf	PBT	10...36	IP 65 / IP 67	10	200	6	KI5083
M12 connector · Output function  · DC PNP/NPN · Wiring diagram no. 20 · Connector groups 8, 10, 11, 18, 19, 21, 23, 25, 148, 149, 150, 153, 154, 184, 188, 190, 193, 202, 203, 204									
	M30 / L = 90	20 nf	PBT	10...36	IP 65 / IP 67	10	200	6	KI5082
M12 connector · Output function  · DC PNP · Wiring diagram no. 3 · Connector groups 8, 10, 19, 21, 23, 25, 148, 149, 153, 184, 188, 193, 202									
	M12 / L = 60	4 f	High-grade st. steel	10...36	IP 65	50	100	7	KF5001
	M12 / L = 61	8 nf	High-grade st. steel	10...36	IP 65	50	100	8	KF5002
M12 connector · Output function  · DC NPN · Wiring diagram no. 4 · Connector groups 8, 10, 19, 21, 23, 25, 148, 149, 153, 184, 188, 193, 202									
	M12 / L = 60	4 f	High-grade st. steel	10...36	IP 65	50	100	7	KF5013

Type	Dimensions [mm]	Sensing range [mm]	Material	U _b [V]	Protection	f [Hz]	I _{load} [mA]	Drawing no.	Order no.
------	--------------------	-----------------------	----------	-----------------------	------------	-----------	---------------------------	-------------	-----------

M12 connector · Output function  /  · DC PNP · Wiring diagram no. 3 · Connector groups 8, 10, 19, 21, 23, 25, 148, 149, 153, 184, 188, 193, 202

	M30 / L = 90	8 f	High-grade st. steel	10...30	IP 65 / IP 67	10	100	9	KI5085
	M30 / L = 90	15 nf	High-grade st. steel	10...30	IP 65 / IP 67	10	100	10	KI5087

M12 connector · Output function  /  · DC PNP · Wiring diagram no. 3 · Connector groups 8, 10, 11, 18, 19, 21, 23, 25, 148, 149, 150, 153, 154, 184, 188, 190, 193, 202, 203, 204



	M18 / L = 92.5	15 nf	PBT	10...30	IP 65 / IP 67 / IP 69K	30	200	11	KG6000
---	----------------	-------	-----	---------	------------------------	----	-----	----	--------

f = flush / nf = non flush / qf = quasi-flush



Sensors for level and position detection AC/DC

Type	Dimensions [mm]	Sensing range [mm]	Material	U _b [V]	Protection	f AC / DC [Hz]	I _{load} AC / DC [mA]	Drawing no.	Order no.
------	--------------------	-----------------------	----------	-----------------------	------------	----------------------	--------------------------------------	-------------	-----------



Cable 2 m · Output function  · AC/DC · Wiring diagram no. 5

	M18 / L = 84	8 nf	PBT	20...250	IP 67	25 / 50	150 / 100	12	KG0009*
	M30 / L = 81	15 nf	PBT	20...250	IP 65	25 / 40	200	13	KI0016*
	120 x 80 x 30	60 nf	modified PPO	20...250	IP 65	10	200	14	KD0012*

Cable 2 m · Output function  · AC/DC · Wiring diagram no. 6

	M18 / L = 84	8 nf	PBT	20...250	IP 67	25 / 50	150 / 100	12	KG0010*
	M30 / L = 81	15 nf	PBT	20...250	IP 65	25 / 40	200	13	KI0020*

1/2" UNF-Connector · Output function  /  · AC/DC · Wiring diagram no. 7 · Connector group 33

	M18 / L = 87	12 nf	PBT	20...250	IP 65 / IP 67	10	100	15	KG0016*
	M30 / L = 90	20 nf	PBT	20...250	IP 65 / IP 67	10	100	16	KI0054*



Position sensors

Type	Dimensions [mm]	Sensing range [mm]	Material	U _b [V]	Protection	f AC / DC [Hz]	I _{load} AC / DC [mA]	Drawing no.	Order no.
------	--------------------	-----------------------	----------	-----------------------	------------	----------------------	--------------------------------------	-------------	-----------

Terminals · Output function · AC/DC · Wiring diagram no. 8

	M30 / L = 125	15 nf	PBT	20...250	IP 65	25 / 40	200	17	KI0024*
--	---------------	-------	-----	----------	-------	---------	-----	----	---------

Terminals · Output function · AC/DC · Wiring diagram no. 21

	105 x 80 x 40	60 nf	modified PPO	20...250	IP 65	10	200	18	KD0009*
--	---------------	-------	--------------	----------	-------	----	-----	----	---------

f = flush / nf = non flush / qf = quasi-flush

* Note on use of miniature fuses for electrical connection

Miniature fuse to IEC60127-2 sheet 1, ≤ 2 A (fast acting) Recommendation: check the unit for reliable function after a short circuit.

Sensors with IO-Link

Type	Dimensions [mm]	Sensing range [mm]	Material	U _b [V]	Protection	f [Hz]	I _{load} [mA]	Drawing no.	Order no.
------	--------------------	-----------------------	----------	-----------------------	------------	-----------	---------------------------	-------------	-----------

M12 connector · Output function · DC PNP · Wiring diagram no. 3 · Connector groups 8, 10, 11, 18, 19, 21, 23, 25, 148, 149, 150, 153, 154, 184, 188, 190, 193, 202, 203, 204

	M30 / L = 92	25 nf	PBT	10...30	IP 65 / IP 67 / IP 69K	40	200	19	KI6000
--	--------------	-------	-----	---------	---------------------------	----	-----	----	--------

Cable 2 m · Output function · DC NPN · Wiring diagram no. 9

	M30 / L = 92	25 nf	PBT	10...30	IP 65 / IP 67 / IP 69K	40	200	20	KI5300
--	--------------	-------	-----	---------	---------------------------	----	-----	----	--------

Cable 2 m · Output function · DC PNP · Wiring diagram no. 10

	M30 / L = 92	25 nf	PBT	10...30	IP 65 / IP 67 / IP 69K	40	200	20	KI5301
--	--------------	-------	-----	---------	---------------------------	----	-----	----	--------

Cable 2 m · Output function · DC NPN · Wiring diagram no. 11



















	M30 / L = 92	25 nf	PBT	10...30	IP 65 / IP 67 / IP 69K	40	200	20	KI5302
--	--------------	-------	-----	---------	---------------------------	----	-----	----	--------

Cable 2 m · Output function · DC PNP · Wiring diagram no. 10

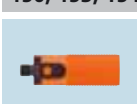
	M30 / L = 92	15 qf	PBT	10...30	IP 65 / IP 67 / IP 69K	40	200	20	KI5304
--	--------------	-------	-----	---------	---------------------------	----	-----	----	--------

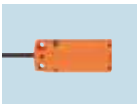
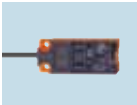









Cable 2 m · Output function · DC PNP · Wiring diagram no. 1













	M30 / L = 92	25 nf	PBT	10...30	IP 65 / IP 67 / IP 69K	40	200	20	KI5303
--	--------------	-------	-----	---------	---------------------------	----	-----	----	--------

Type	Dimensions [mm]	Sensing range [mm]	Material	U _b [V]	Protection	f [Hz]	I _{load} [mA]	Draw- ing no.	Order no.
Cable 2 m · Output function  · DC PNP · Wiring diagram no. 12									
	M30 / L = 92	15 qf	PBT	10...30	IP 65 / IP 67 / IP 69K	40	200	20	KI5305
M12 connector · Output function  · DC NPN · Wiring diagram no. 4 · Connector groups 8, 10, 19, 21, 23, 25, 148, 149, 153, 184, 188, 193, 202									
	M30 / L = 92	25 nf	PBT	10...30	IP 65 / IP 67 / IP 69K	40	200	21	KI5306
M12 connector · Output function  · DC PNP · Wiring diagram no. 13 · Connector groups 8, 10, 11, 18, 19, 21, 23, 25, 148, 149, 150, 153, 154, 184, 188, 190, 193, 202, 203, 204									
	M30 / L = 92	25 nf	PBT	10...30	IP 65 / IP 67 / IP 69K	40	200	21	KI5307
M12 connector · Output function  · DC NPN · Wiring diagram no. 14 · Connector groups 8, 10, 19, 21, 23, 25, 148, 149, 153, 184, 188, 193, 202									
	M30 / L = 92	25 nf	PBT	10...30	IP 65 / IP 67 / IP 69K	40	200	21	KI5308
M12 connector · Output function  · DC PNP · Wiring diagram no. 15 · Connector groups 8, 10, 11, 18, 19, 21, 23, 25, 148, 149, 150, 153, 154, 184, 188, 190, 193, 202, 203, 204									
	M30 / L = 92	25 nf	PBT	10...30	IP 65 / IP 67 / IP 69K	40	200	21	KI5309
M12 connector · Output function  · DC PNP · Wiring diagram no. 13 · Connector groups 8, 10, 11, 18, 19, 21, 23, 25, 148, 149, 150, 153, 154, 184, 188, 190, 193, 202, 203, 204									
	M30 / L = 92	15 qf	PBT	10...30	IP 65 / IP 67 / IP 69K	40	200	21	KI5310
M12 connector · Output function  · DC PNP · Wiring diagram no. 15 · Connector groups 8, 10, 11, 18, 19, 21, 23, 25, 148, 149, 150, 153, 154, 184, 188, 190, 193, 202, 203, 204									
	M30 / L = 92	15 qf	PBT	10...30	IP 65 / IP 67 / IP 69K	40	200	21	KI5311
Cable 2 m · Output function  /  · DC PNP · Wiring diagram no. 2									
	20 x 7 x 48	12 nf	PBT	10...30	IP 65 / IP 67	10	100	22	KQ5100
	20 x 14 x 48	12 nf	PBT	10...30	IP 65 / IP 67	10	100	23	KQ6002
Cable with connector 0.04 m · Output function  /  · DC PNP · Wiring diagram no. 3 · Connector groups 1, 2, 3, 78, 84, 145, 146									
	20 x 7 x 48	12 nf	PBT	10...30	IP 65 / IP 67	10	100	24	KQ5102







Position sensors

Type	Dimensions [mm]	Sensing range [mm]	Material	U _b [V]	Protection	f [Hz]	I _{load} [mA]	Drawing no.	Order no.
Cable with connector 0.04 m · Output function · DC PNP · Wiring diagram no. 3 · Connector groups 4, 5, 80, 86, 147									
	20 x 14 x 48	12 nf	PBT	10...30	IP 65 / IP 67	10	100	25	KQ6004
Cable with connector 0.1 m · Output function · DC PNP · Wiring diagram no. 3 · Connector groups 8, 10, 19, 21, 23, 25, 148, 149, 153, 184, 188, 193, 202									
	20 x 7 x 48	12 nf	PBT	10...30	IP 65 / IP 67	10	100	26	KQ5101
	20 x 14 x 48	12 nf	PBT	10...30	IP 65 / IP 67	10	100	27	KQ6005
M12 connector · Output function · DC PNP · Wiring diagram no. 3 · Connector groups 8, 10, 11, 18, 19, 21, 23, 25, 148, 149, 150, 153, 154, 184, 188, 190, 193, 202, 203, 204									
	M18 / L = 92.5	15 nf	PBT	10...30	IP 65 / IP 67 / IP 69K	30	200	11	KG6000
Cable 2 m · Output function · DC NPN · Wiring diagram no. 9									
	M18 / L = 92.5	15 nf	PBT	10...30	IP 65 / IP 67 / IP 69K	30	200	28	KG5300
Cable 2 m · Output function · DC PNP · Wiring diagram no. 10									
	M18 / L = 92.5	15 nf	PBT	10...30	IP 65 / IP 67 / IP 69K	30	200	28	KG5301
Cable 2 m · Output function · DC NPN · Wiring diagram no. 11									
	M18 / L = 92.5	15 nf	PBT	10...30	IP 65 / IP 67 / IP 69K	30	200	28	KG5302
Cable 2 m · Output function · DC PNP · Wiring diagram no. 1									
	M18 / L = 92.5	15 nf	PBT	10...30	IP 65 / IP 67 / IP 69K	30	200	28	KG5303
Cable 2 m · Output function · DC PNP · Wiring diagram no. 10									
	M18 / L = 92.5	8 qf	PBT	10...30	IP 65 / IP 67 / IP 69K	30	200	28	KG5304
Cable 2 m · Output function · DC NPN · Wiring diagram no. 1									
	M18 / L = 92.5	8 qf	PBT	10...30	IP 65 / IP 67 / IP 69K	30	200	28	KG5305

Type	Dimensions [mm]	Sensing range [mm]	Material	U _b [V]	Protection	f [Hz]	I _{load} [mA]	Draw- ing no.	Order no.
M12 connector · Output function  · DC NPN · Wiring diagram no. 4 · Connector groups 8, 10, 19, 21, 23, 25, 148, 149, 153, 184, 188, 193, 202									
	M18 / L = 92.5	15 nf	PBT	10...30	IP 65 / IP 67 / IP 69K	30	200	29	KG5306
M12 connector · Output function  · DC PNP · Wiring diagram no. 13 · Connector groups 8, 10, 11, 18, 19, 21, 23, 25, 148, 149, 150, 153, 154, 184, 188, 190, 193, 202, 203, 204									
	M18 / L = 92.5	15 nf	PBT	10...30	IP 65 / IP 67 / IP 69K	30	200	29	KG5307
M12 connector · Output function  · DC NPN · Wiring diagram no. 14 · Connector groups 8, 10, 19, 21, 23, 25, 148, 149, 153, 184, 188, 193, 202									
	M18 / L = 92.5	15 nf	PBT	10...30	IP 65 / IP 67 / IP 69K	30	200	29	KG5308
M12 connector · Output function  · DC PNP · Wiring diagram no. 15 · Connector groups 8, 10, 11, 18, 19, 21, 23, 25, 148, 149, 150, 153, 154, 184, 188, 190, 193, 202, 203, 204									
	M18 / L = 92.5	15 nf	PBT	10...30	IP 65 / IP 67 / IP 69K	30	200	29	KG5309
M12 connector · Output function  · DC PNP · Wiring diagram no. 13 · Connector groups 8, 10, 11, 18, 19, 21, 23, 25, 148, 149, 150, 153, 154, 184, 188, 190, 193, 202, 203, 204									
	M18 / L = 92.5	8 qf	PBT	10...30	IP 65 / IP 67 / IP 69K	30	200	29	KG5310
M12 connector · Output function  · DC PNP · Wiring diagram no. 15 · Connector groups 8, 10, 11, 18, 19, 21, 23, 25, 148, 149, 150, 153, 154, 184, 188, 190, 193, 202, 203, 204									
	M18 / L = 92.5	8 qf	PBT	10...30	IP 65 / IP 67 / IP 69K	30	200	29	KG5311







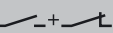

f = flush / nf = non flush / qf = quasi-flush

Sensors with ATEX approval

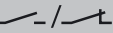
Type	Dimensions [mm]	Sensing range [mm]	Material	U _{nom.} at 1 KΩ [V]	U _b [V]	Internal capacit. [nF]	Internal inductance [μH]	f [Hz]	Draw- ing no.	Order no.
Cable 2 m · Output function  · Connection to certified intrinsically safe circuits with the max. values U = 15 V / I = 50 mA / P = 120 mW · Wiring diagram no. 16										
	M30 / L = 81	15 nf	PBT	8.2 DC	7.5...15	375	1	40	13	KI5030
Cable 2 m · Output function  · Connection to certified intrinsically safe circuits with the max. values U = 15 V / I = 50 mA / P = 120 mW · Wiring diagram no. 17										
	M34 / L = 92	15 nf	Brass	8.2 DC	7.5...15	375	1	40	30	KX5001

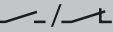

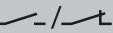
Position sensors

Type	Dimensions [mm]	Sensing range [mm]	Material	U _{nom.} at 1 K Ω [V]	U _b [V]	Internal capacit. [nF]	Internal inductance [μ H]	f [Hz]	Draw- ing no.	Order no.
Terminals · Output function  · DC PNP · Wiring diagram no. 18										
	M30 / L = 150	15 nf	PBT	10...30 DC	–	–	–	10	31	KI503A
	M30 / L = 125	15 nf	PBT	10...30 DC	–	–	–	10	32	KI505A
Terminals · Output function  · AC/DC · Wiring diagram no. 22										
	M30 / L = 150	15 nf	PBT	20...250 DC / 30...250 AC	–	–	–	10	31	KI000A*
	M30 / L = 125	15 nf	PBT	20...250 DC / 30...250 AC	–	–	–	10	32	KI001A*
Terminals · Output function  · AC/DC · Wiring diagram no. 21										
	105 x 80 x 42	60 nf	modified PPE	20...250 AC/DC	–	–	–	4	33	KD001A*
Terminals · Output function  · DC PNP · Wiring diagram no. 23										
	105 x 80 x 42	60 nf	modified PPO	10...36 DC	–	–	–	10	33	KD501A

f = flush / nf = non flush / qf = quasi-flush

* Note on use of miniature fuses for electrical connection









Miniature fuse to IEC60127-2 sheet 1, ≤ 2 A (fast acting) Recommendation: check the unit for reliable function after a short circuit.

Switching amplifiers with ATEX approval

Type	U _b [V]	Power / current consumption [VA] / [mA]	f [Hz]	T _a [°C]	Output	Protection	Draw- ing no.	Order no.
	115	1.0 /	10	-20...60	relay (1 changeover contact)	IP 20	34	N0030A
	230	1.0 /	10	-20...60	relay (1 changeover contact)	IP 20	34	N0031A
	115	1.3 /	10	-20...60	relay (1 changeover contact per channel)	IP 20	34	N0032A
	230	1.3 /	10	-20...60	relay (1 changeover contact per channel)	IP 20	34	N0033A
	24	/ < 23	10	-20...60	relay (1 changeover contact)	IP 20	34	N0530A

Type	U _b [V]	Power / current consumption [VA] / [mA]	f [Hz]	T _a [°C]	Output	Protection	Draw- ing no.	Order no.
	24	/ < 50	5000	-20...60	2 transistor outputs PNP (100 mA, short-circuit protection)	IP 20	34	N0531A
	24	/ < 50	5000	-20...60	2 outputs (optocoupler, bipolar, 100 mA, short-circuit protection)	IP 20	34	N0532A
	24	/ < 50	10	-20...60	relay (1 changeover contact per channel)	IP 20	34	N0533A
	24	/ < 50	5000	-20...60	2 transistor outputs PNP (100 mA, short-circuit protection)	IP 20	34	N0534A

Dynamic capacitive touch sensors

Type	U _b [V]	I _{load} [mA]	Current consumption [mA]	Ambient temperature [°C]	Protection	Draw- ing no.	Order no.
Cable 2 m · Output function  · DC PNP							
	24	200	30	-40...85	IP 67 / IP 69K	35	KT5010
Cable with connector 0.3 m · Output function  · DC PNP · Connector groups 4, 5, 80, 86, 147							
	24	200	30	-40...85	IP 67 / IP 69K	35	KT5011
Cable 2 m · Output function  · DC PNP							
	24	200	30	-40...85	IP 65 / IP 67 / IP 69K	36	KT5309
Cable with connector 0.3 m · Output function  · DC PNP · Connector groups 8, 10, 11, 18, 19, 21, 23, 25, 148, 149, 150, 153, 154, 184, 188, 190, 193, 202, 203, 204							
	24	200	30	-40...85	IP 65 / IP 67 / IP 69K	37	KT5102
	24	200	30	-40...85	IP 65 / IP 67 / IP 69K	37	KT5112
Cable 2 m · Output function  · DC PNP							
	24	200	30	-40...85	IP 65 / IP 67 / IP 69K	37	KT5111



Position sensors

Static capacitive touch sensors

Type	U _b [V]	I _{load} [mA]	Current consumption [mA]	Ambient temperature [°C]	Protection	Drawing no.	Order no.
------	-----------------------	---------------------------	-----------------------------	-----------------------------	------------	-------------	-----------

Cable 2 m · Output function  · DC PNP

	24	200	30	-40...85	IP 67 / IP 69K	35	KT5012
---	----	-----	----	----------	----------------	----	--------



Cable with connector 0.3 m · Output function  · DC PNP · Connector groups 4, 5, 80, 86, 147

	24	200	30	-40...85	IP 67 / IP 69K	35	KT5013
---	----	-----	----	----------	----------------	----	--------

Cable with connector 0.3 m · Output function  · DC PNP · Connector groups 8, 10, 11, 18, 19, 21, 23, 25, 148, 149, 150, 153, 154, 184, 188, 190, 193, 202, 203, 204

	24	200	30	-40...85	IP 65 / IP 67 / IP 69K	37	KT5106
---	----	-----	----	----------	------------------------	----	--------

Cable 2 m · Output function  · DC PNP

	24	200	30	-40...85	IP 65 / IP 67 / IP 69K	37	KT5110
	24	200	30	-40...85	IP 65 / IP 67 / IP 69K	36	KT5310

Capacitive touch sensors with latching evaluation principle

Type	U _b [V]	I _{load} [mA]	Current consumption [mA]	Ambient temperature [°C]	Protection	Drawing no.	Order no.
------	-----------------------	---------------------------	-----------------------------	-----------------------------	------------	-------------	-----------

Cable 2 m · Output function  · DC PNP

	24	200	30	-40...85	IP 65 / IP 67 / IP 69K	37	KT5150
---	----	-----	----	----------	------------------------	----	--------

Cable 0.3 m · Output function  · DC PNP · Connector groups 8, 10, 11, 18, 19, 21, 23, 25, 148, 149, 150, 153, 154, 184, 188, 190, 193, 202, 203, 204

	24	200	30	-40...85	IP 65 / IP 67 / IP 69K	37	KT5151
---	----	-----	----	----------	------------------------	----	--------

Cable 2 m · Output function  · DC PNP

	24	200	30	-40...85	IP 65 / IP 67 / IP 69K	36	KT5350
---	----	-----	----	----------	------------------------	----	--------

Cable 0.3 m · Output function  · DC PNP · Connector groups 8, 10, 11, 18, 19, 21, 23, 25, 148, 149, 150, 153, 154, 184, 188, 190, 193, 202, 203, 204











	24	200	30	-40...85	IP 65 / IP 67 / IP 69K	36	KT5351
---	----	-----	----	----------	------------------------	----	--------

Product selectors and further information can be found at: www.ifm.com

Software

Type	Description	Order no.
	LR DEVICE (USB stick) · Parameter setting of the units via the network · Software for clear online and offline parameter setting of IO-Link sensors via USB adapter · Use via USB connection cable (drivers are supplied): E30396 IO-Link interface or E30390 IO-Link master (note the respective data sheet) · IODD import and update from ifm's homepage · Reading of IODDs via storage media · Automatic sensor identification · Graphic representation of the process values and history incl. export function · Documentation and archiving · Transferable parameter sets · Full memory plug support for IO-Link 1.1	QA0011
	LR DEVICE (download) · Parameter setting of the units via the network · Software for clear online and offline parameter setting of IO-Link sensors via USB adapter · Use via USB connection cable (drivers are supplied): E30396 IO-Link interface or E30390 IO-Link master (note the respective data sheet) · IODD import and update from ifm's homepage · Reading of IODDs via storage media · Automatic sensor identification · Graphic representation of the process values and history incl. export function · Documentation and archiving · Transferable parameter sets · Full memory plug support for IO-Link 1.1	QA0012

Accessories

Type	Description	Order no.
	Memory plug · Parameter memory for IO-Link sensors · Storage capacity: 2 Kbytes · Housing materials: PA PACM 12 / PET / sealing: FPM / nut: stainless steel 316L / 1.4404 / connector: TPU	E30398
	Cover ring 100 mm · for type KT50 · Housing materials: polycarbonate-ABS yellow	E80372
	Cover ring 100 mm · for type KT50 · Housing materials: polycarbonate-ABS green	E80373
	Cover ring 100 mm · for type KT50 · Housing materials: polycarbonate-ABS Red	E80374
	Cover ring 100 mm · for type KT50 · Housing materials: polycarbonate-ABS blue	E80375
	Cover ring 100 mm · for type KT50 · Housing materials: polycarbonate-ABS orange	E80376
	Symbol disc (plastic) · Ø 20.4 mm · for type KT51 / KT53 · Start symbol · Housing materials: Polyamide	E12377
	Symbol disc (plastic) · Ø 20.4 mm · for type KT51 / KT53 · Symbol Stop · Housing materials: Polyamide	E12378
	Symbol disc (plastic) · Ø 20.4 mm · for type KT51 / KT53 · Symbol ON · Housing materials: Polyamide	E12379
	Symbol disc (plastic) · Ø 20.4 mm · for type KT51 / KT53 · Symbol OFF · Housing materials: Polyamide	E12380



Position sensors





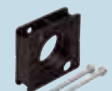

Type	Description	Order no.
	Symbol disc (plastic) · Ø 20.4 mm · for type KT51 / KT53 · Without symbol, transparent · Housing materials: Polyamide	E12386

Accessories mounting adapters

Type	Description	Order no.
	Mounting adapter · M18 x 1 - G $\frac{3}{4}$ · Housing materials: POM	E43900
	Mounting adapter · M18 x 1 - G 1 · Housing materials: POM	E43904
	Mounting adapter · M30 x 1.5 - G $1\frac{1}{4}$ · Housing materials: PVDF / EPDM	E11036
	Mounting adapter · M30 x 1.5 - G $1\frac{1}{2}$ · Housing materials: PVDF / EPDM	E11034
	Mounting adapter · Ø 34 mm - G $1\frac{1}{2}$ · Housing materials: POM	E11027
	Locknut · G $\frac{3}{4}$ · for mounting adapter · Housing materials: POM	E43902
	Locknut · G $1\frac{1}{4}$ · for mounting adapter · Housing materials: PVDF	E11030
	Locknut · G $1\frac{1}{2}$ · for mounting adapter · Housing materials: PVDF	E11032
	Protective cover · G $1\frac{1}{4}$ · for mounting adapter · Housing materials: PES black transparent	E11078

Accessories mounting components

Type	Description	Order no.
	Mounting clamp · Ø 20 mm - Ø 18 mm · with reducing bush · for type M18 · Housing materials: PBT	E10076
	Mounting clamp · Ø 34 mm - Ø 30 mm · with reducing bush · for type M30 · Housing materials: PBT	E10077

Type	Description	Order no.
	Angle bracket · for type M12 · Housing materials: stainless steel	E10735
	Angle bracket · for type M18 · Housing materials: stainless steel	E10736
	Angle bracket · for type M30 · Housing materials: stainless steel	E10737
	Mounting adapter for free-standing mounting · for type KQ5, KQ6 · Housing materials: adapter: PBT / inserts: Brass / screw: steel galvanised	E12153
	Mounting adapter · Pipe and tube installation KQ5 / KQ6 with cable ties · Fixing of the types KQ5 and KQ6 to pipes and tubes · Housing materials: Mounting adapter: PA 12 black	E12163
	Fixing strap · Length: 760 mm · for capacitive level sensors · for type KNQ, KQ5, KQ6 · Housing materials: PA	E10880
	Mounting set · M30 x 1.5 / G 1/4...G 1 · for capacitive sensors on rising pipes G 1/4" - 1" · Housing materials: POM	E11037

Wiring diagrams

Core colours

- BN brown
- BU blue
- BK black
- GN/YE green/yellow

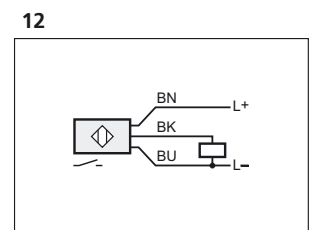
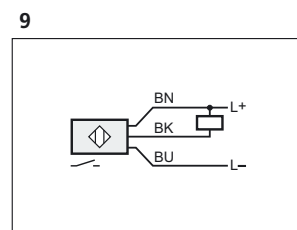
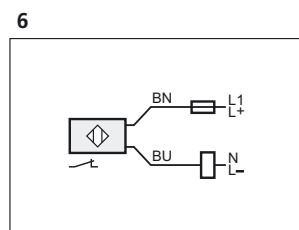
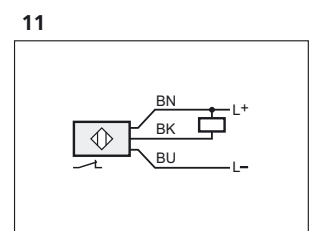
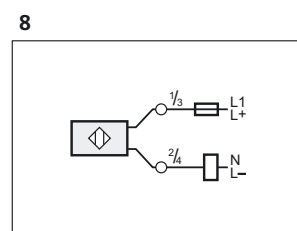
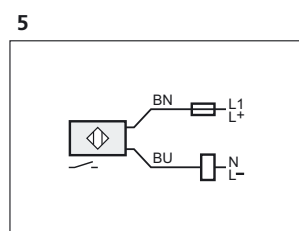
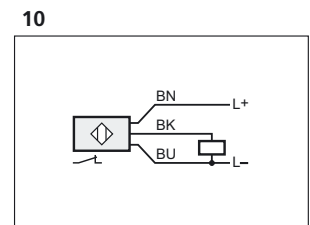
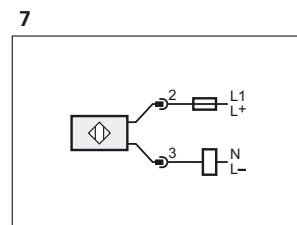
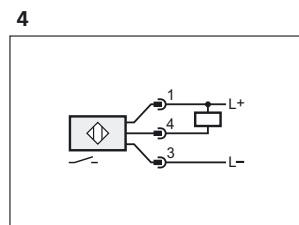
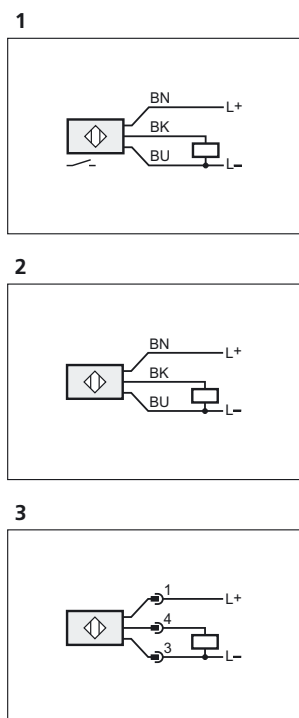



Position sensors

Wiring diagrams

13

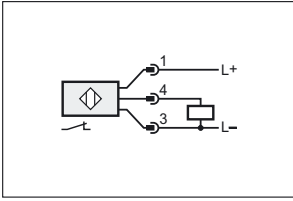

15

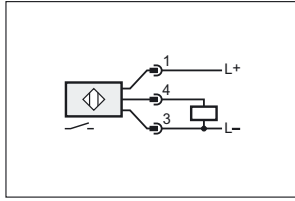

17

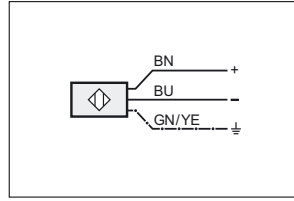

14

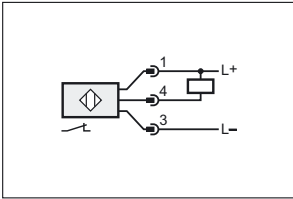

16

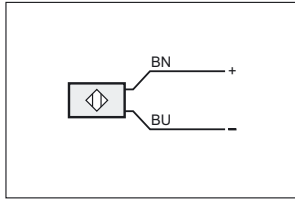

18

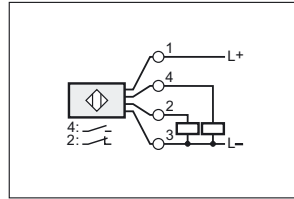

19

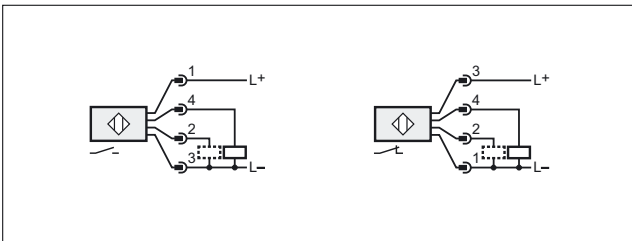

2: function check output / programming wire

20

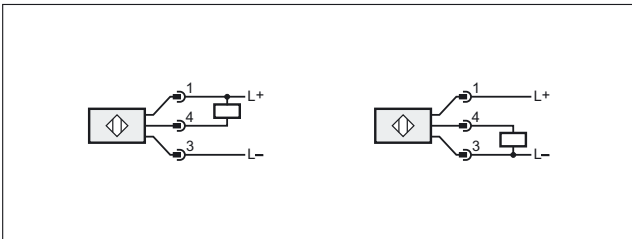

21

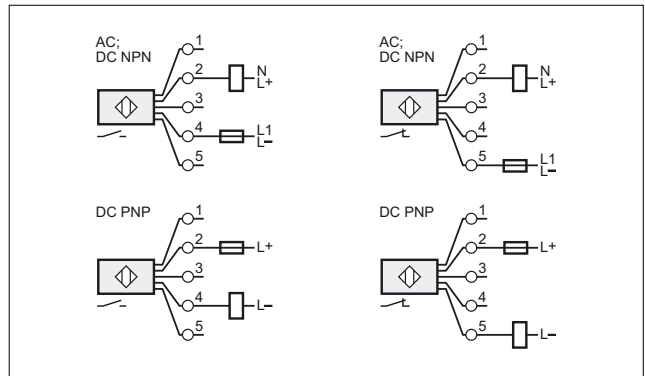

22

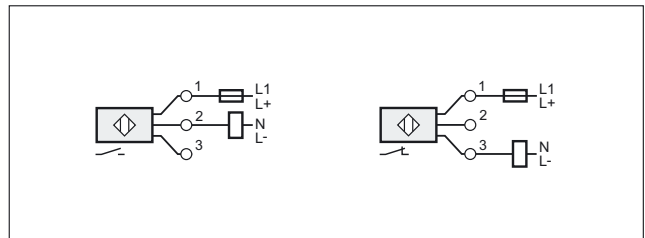

23

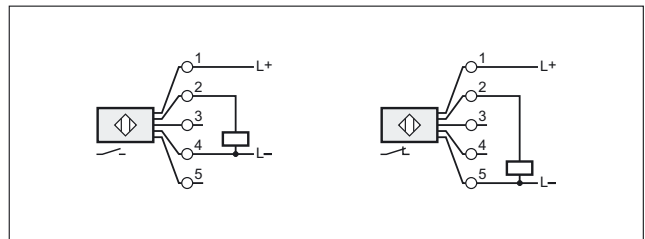

Scale drawings / drawing no. – CAD download: www.ifm.com

1

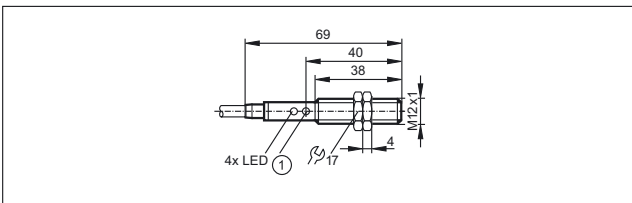

2

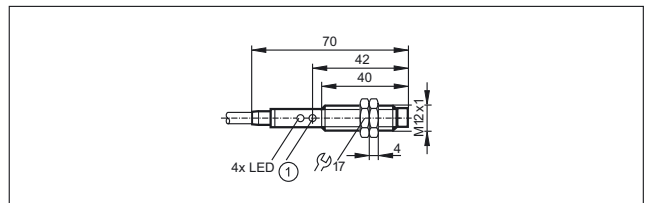

Scale drawings / drawing no. – CAD download: www.ifm.com

3

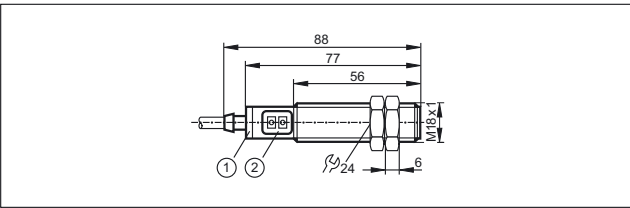

1: LED ring, 2: Programming buttons

4

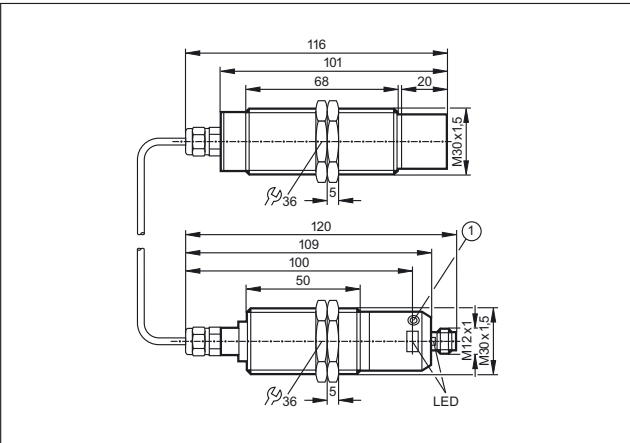

1: Programming button

5

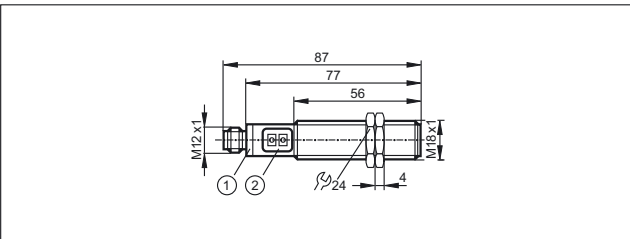

1: LED ring, 2: Programming buttons

6

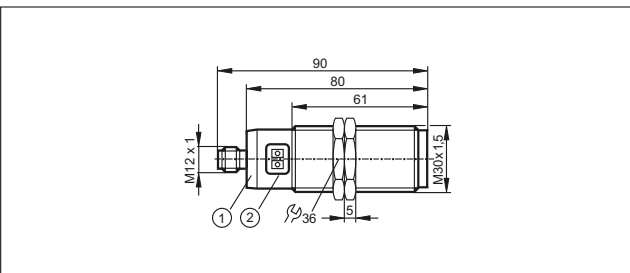

1: LED ring, 2: Programming buttons

7

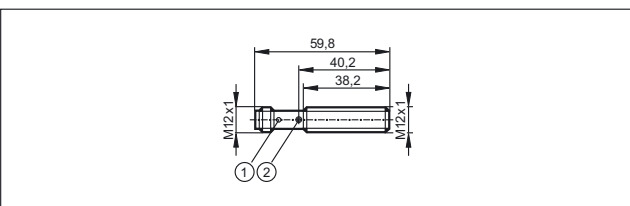

1: LED 4 x 90°, 2: potentiometer

8

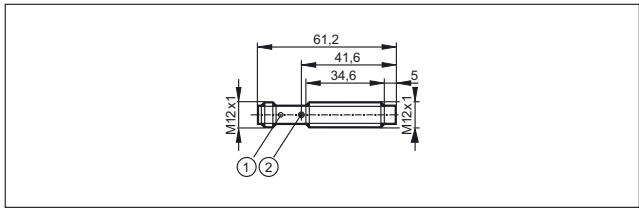

1: LED 4 x 90°, 2: potentiometer

9

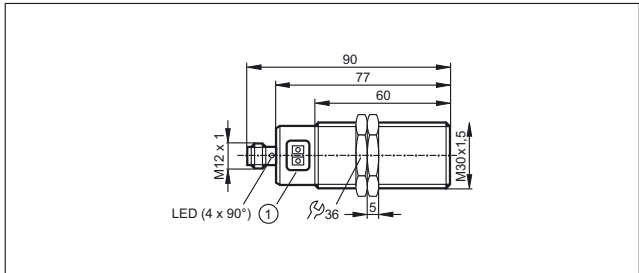

1: Programming buttons

10

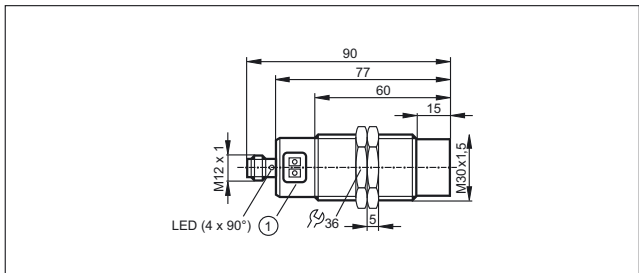

1: Programming buttons

11

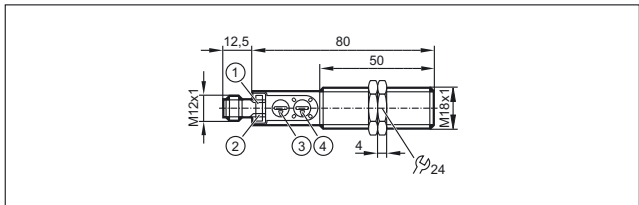

1: LED yellow (output status indication), 2: LED green (output status indication), 3: Potentiometer (sensing range), 4: Potentiometer (switching function)

12

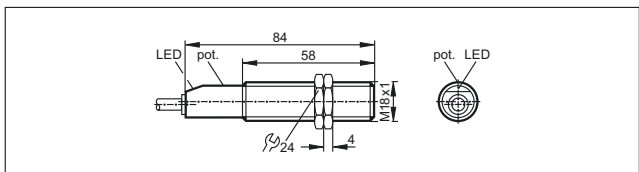

13

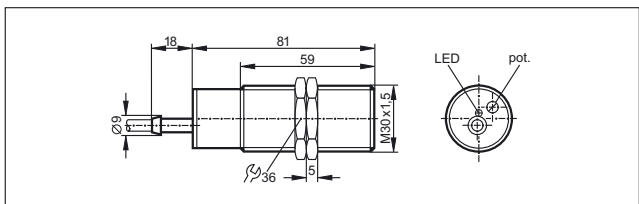



Position sensors

Scale drawings / drawing no. – CAD download: www.ifm.com

14

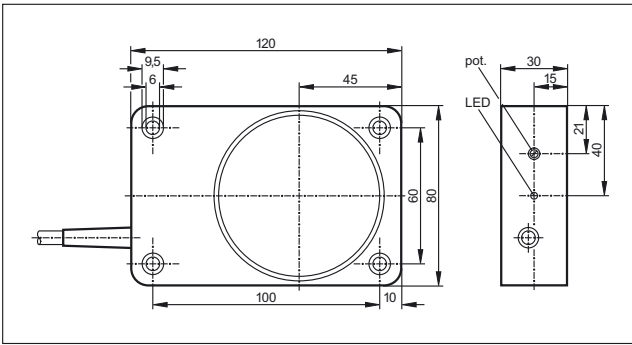

15

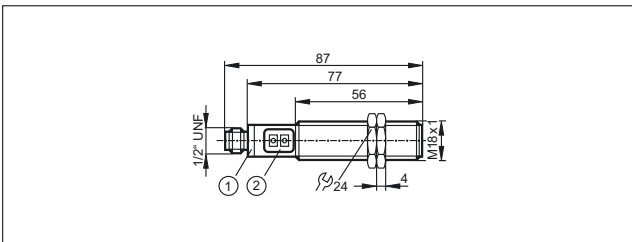

16

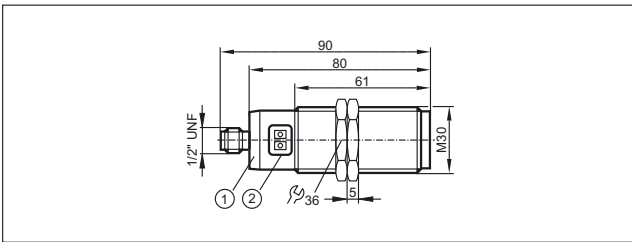

1: LED ring, 2: Programming buttons

17

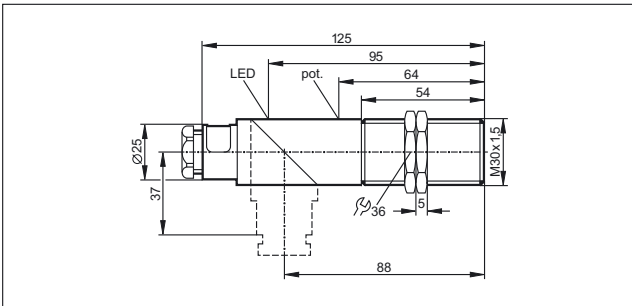

18

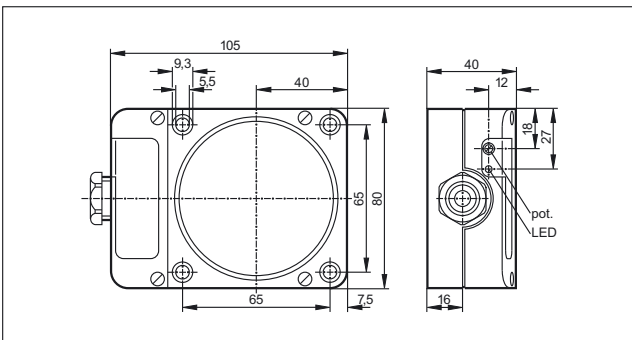

19

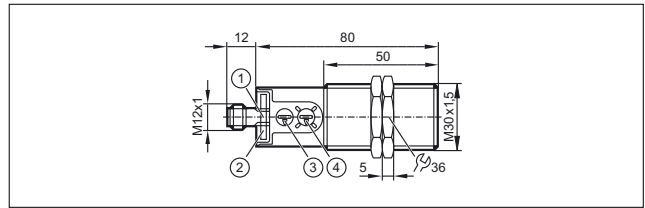

1: LED yellow (output status indication), 2: LED green (output status indication), 3: Potentiometer (sensing range), 4: Potentiometer (switching function)

20

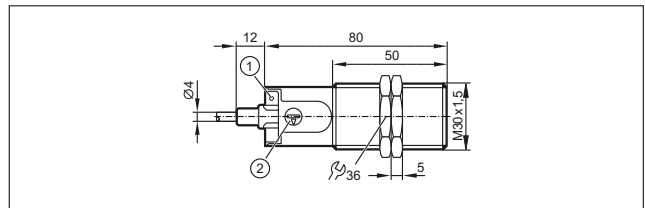

1: LED yellow (output status indication), 2: Potentiometer (sensing range)

21

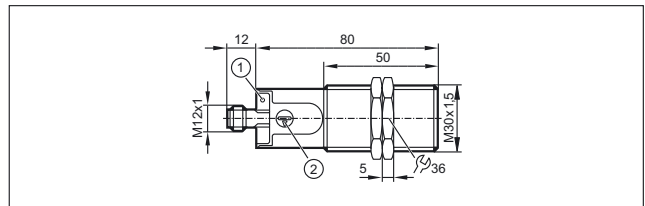

1: LED yellow (output status indication), 2: Potentiometer (sensing range)

22

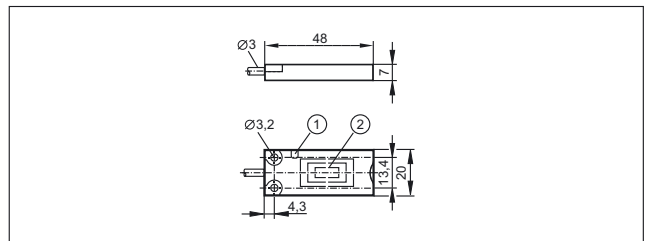

1: LED, 2: sensing face

23

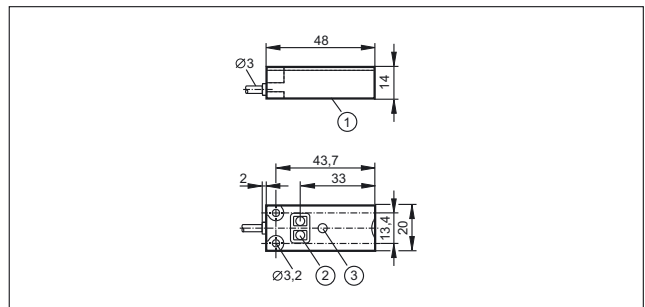

1: sensing face, 2: Programming buttons, 3: LED

Scale drawings / drawing no. – CAD download: www.ifm.com

24

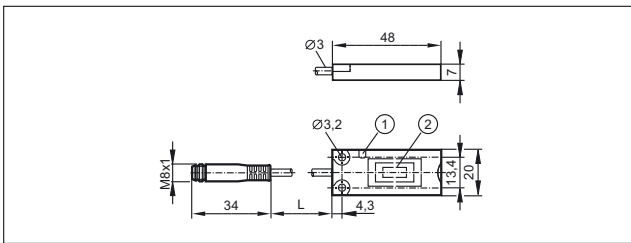

1: LED, 2: sensing face

25

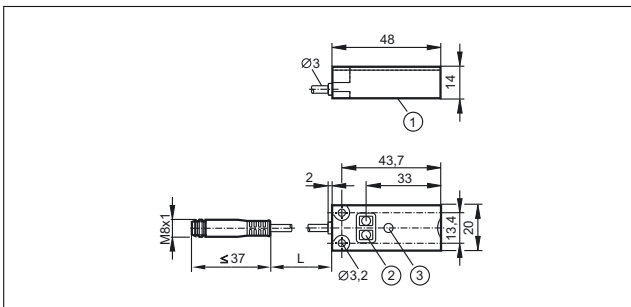

1: sensing face, 2: Programming buttons, 3: LED

26

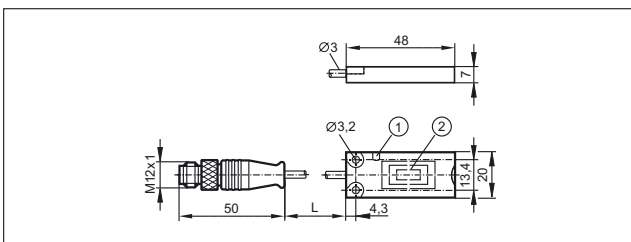

1: LED, 2: sensing face

27

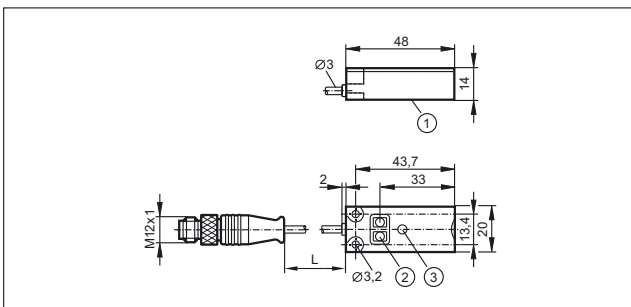

1: sensing face, 2: Programming buttons, 3: LED

28

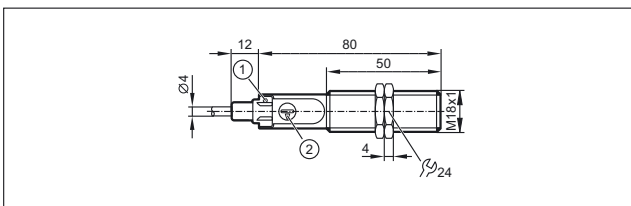

29

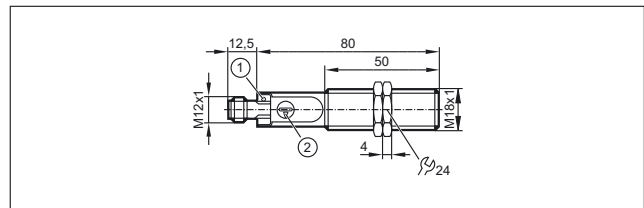

1: LED yellow (output status indication), 2: Potentiometer (sensing range)

30

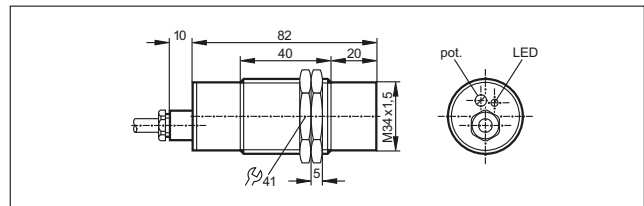

31

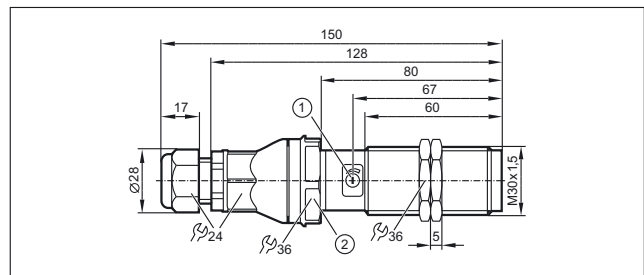

1: potentiometer, 2: tightening torque 10 Nm

32

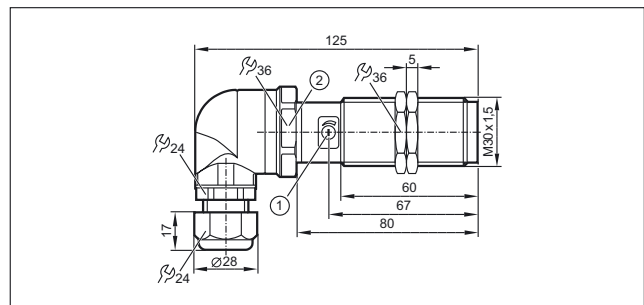

1: potentiometer, 2: tightening torque 10 Nm

33

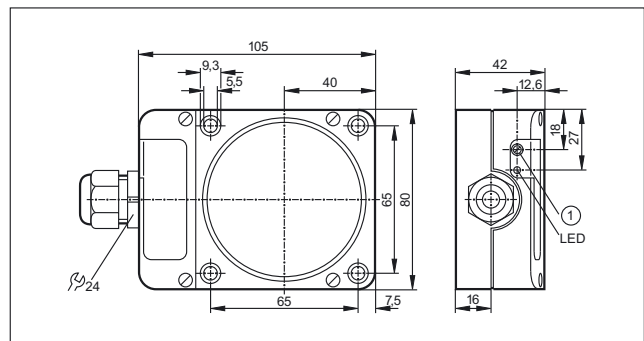

1: potentiometer



Position sensors

Scale drawings / drawing no. – CAD download: www.ifm.com

34

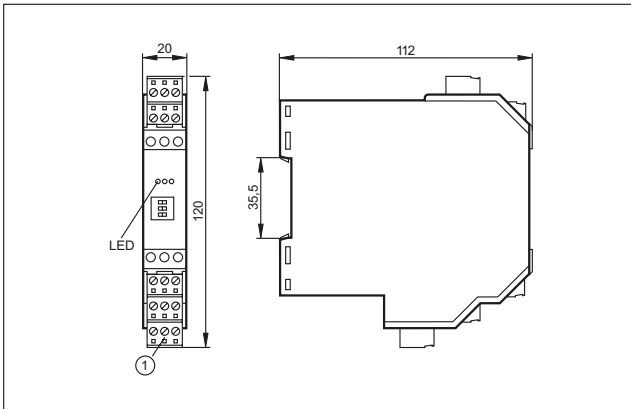

1: Combicon plug with screw terminals (optional)

35

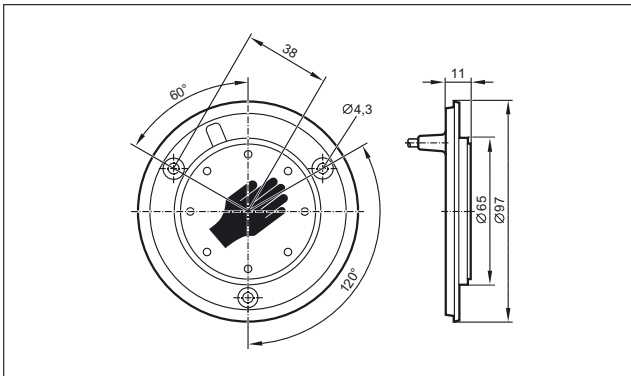

36

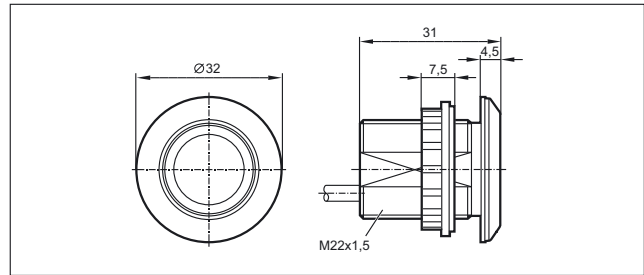

37

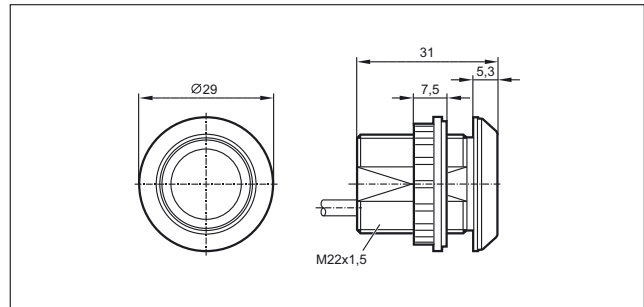





Non-contact and wear-free detection with magnetic sensors



Magnetic sensors



Detection also through non-magnetisable metals

Small designs with very long sensing ranges up to 100 mm

Cylinder and rectangular designs for demanding applications

High mechanical stability in case of shock or vibration

Flush or non-flush installation in non-magnetisable metals

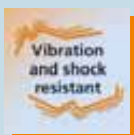

Vibration and shock resistant



IP 68
IP 69 K



Temperature resistant up to 120°C

Magnetic sensors

Magnetic sensors are used in automation to detect positions without contact or wear and tear. Magnetic sensors come into their own where inductive sensors reach their limits. Advantage: Magnetic sensors offer small designs with very long sensing ranges. Depending on the orientation of the magnetic field, the sensor can be damped from the front or from the side. Since magnetic fields penetrate all non-magnetisable materials, the sensors can detect magnets through walls made of non-ferrous metal, stainless steel, aluminium, plastic or wood.

















In the food industry, for example, magnetic sensors are often used in connection with pigs (cleaning devices which pass through the inside of pipes). Magnetic sensors are used to determine their exact position from the outside through the wall of the stainless steel pipe.

System overview	Page
Full-metal sensors for high-pressure resistant applications on hydraulic cylinders and valves	182 - 183
Full metal sensors for industrial applications	183
Sensors for industrial applications	184
Full metal sensors for hygienic and wet areas	185
Sensors for hygienic and wet areas	185
Accessories damping magnets	185 - 186
Accessories mounting components	186 - 187
Accessories mounting sets	187
Wiring diagrams	187 - 188
Scale drawings / drawing no. – CAD download: www.ifm.com	188 - 189



Position sensors

Full-metal sensors for high-pressure resistant applications on hydraulic cylinders and valves

Type	Dimensions [mm]	Sensing range [mm]	Material	U _b [V]	Protection	f [Hz]	I _{load} [mA]	Drawing no.	Order no.
M12 connector · Output function  · DC PNP · Wiring diagram no. 1 · Connector groups 8, 10, 11, 18, 19, 21, 23, 25, 148, 149, 150, 153, 154, 184, 188, 190, 193, 202, 203, 204									
	M12 / L = 93	1.8 f	High-grade st. steel	10...36	IP 65 / IP 68 / IP 69K	1000	200	1	MFH200
M12 connector · Output function  · DC NPN · Wiring diagram no. 2 · Connector groups 8, 10, 19, 21, 23, 25, 148, 149, 153, 184, 188, 193, 202									
	M12 / L = 93	1.8 f	High-grade st. steel	10...36	IP 65 / IP 68 / IP 69K	1000	200	1	MFH201
M12 connector · Output function  · DC PNP · Wiring diagram no. 1 · Connector groups 8, 10, 11, 18, 19, 21, 23, 25, 148, 149, 150, 153, 154, 184, 188, 190, 193, 202, 203, 204									
	M12 / L = 60	1.8 f	High-grade st. steel	10...36	IP 65 / IP 68 / IP 69K	1000	200	2	MFH202
M12 connector · Output function  · DC NPN · Wiring diagram no. 2 · Connector groups 8, 10, 19, 21, 23, 25, 148, 149, 153, 184, 188, 193, 202									
	M12 / L = 60	1.8 f	High-grade st. steel	10...36	IP 65 / IP 68 / IP 69K	1000	200	2	MFH203
M12 connector · Output function  · DC PNP · Wiring diagram no. 3 · Connector groups 8, 10, 19, 21, 23, 25, 148, 149, 153, 184, 188, 193, 202									
	M12 / L = 60	1.8 f	High-grade st. steel	10...36	IP 65 / IP 68 / IP 69K	1000	200	2	MFH204
Cable 2 m · Output function  · DC PNP · Wiring diagram no. 4									
	M12 / L = 40	1.8 f	High-grade st. steel	10...36	IP 65 / IP 68 / IP 69K	1000	200	3	MFH205
Cable 2 m · Output function  · DC NPN · Wiring diagram no. 5									
	M12 / L = 40	1.8 f	High-grade st. steel	10...36	IP 65 / IP 68 / IP 69K	1000	200	3	MFH206
Cable 2 m · Output function  · DC PNP · Wiring diagram no. 6									
	M12 / L = 40	1.8 f	High-grade st. steel	10...36	IP 65 / IP 68 / IP 69K	1000	200	3	MFH207
Cable 2 m · Output function normally open / closed · DC PNP · Wiring diagram no. 7									
	M12 / L = 40	1.8 f	High-grade st. steel	10...36	IP 65 / IP 68 / IP 69K	1000	200	3	MFH208

Type	Dimensions [mm]	Sensing range [mm]	Material	U _b [V]	Protection	f [Hz]	I _{load} [mA]	Drawing no.	Order no.
------	--------------------	-----------------------	----------	-----------------------	------------	-----------	---------------------------	-------------	-----------

M12 connector · Output function normally open / closed · DC PNP · Wiring diagram no. 8

	M12 / L = 60	1.8 f	High-grade st. steel	10...36	IP 65 / IP 68 / IP 69K	1000	100	4	MFH209
---	--------------	-------	----------------------	---------	------------------------	------	-----	---	---------------

M12 connector · Output function  · DC PNP · Wiring diagram no. 1 · Connector groups 8, 10, 11, 18, 19, 21, 23, 25, 148, 149, 150, 153, 154, 184, 188, 190, 193, 202, 203, 204

	M14 / L = 53	2 f	High-grade st. steel	10...36	IP 65 / IP 68 / IP 69K	1000	200	5	M9H200
---	--------------	-----	----------------------	---------	------------------------	------	-----	---	---------------

f = flush / nf = non flush / qf = quasi-flush

Full metal sensors for industrial applications

Type	Dimensions [mm]	Sensing range [mm]	Material	U _b [V]	Protection	f [Hz]	I _{load} [mA]	Drawing no.	Order no.
------	--------------------	-----------------------	----------	-----------------------	------------	-----------	---------------------------	-------------	-----------

M12 connector · Output function  · DC PNP · Wiring diagram no. 1 · Connector groups 148, 149, 150, 153, 154, 184, 188, 190, 193, 202, 203, 204

	M12 / L = 60	60	High-grade st. steel	10...30	IP 65 / IP 67	5000	200	6	MFS211
---	--------------	----	----------------------	---------	---------------	------	-----	---	---------------

	M18 / L = 60	70	High-grade st. steel	10...30	IP 65 / IP 67	5000	200	7	MGS204
---	--------------	----	----------------------	---------	---------------	------	-----	---	---------------

M12 connector · Output function  · DC NPN · Wiring diagram no. 2 · Connector groups 148, 149, 153, 184, 188, 193, 202

	M12 / L = 60	60	High-grade st. steel	10...30	IP 65 / IP 67	5000	200	6	MFS209
---	--------------	----	----------------------	---------	---------------	------	-----	---	---------------

M12 connector · Output function  · DC PNP · Wiring diagram no. 3 · Connector groups 148, 149, 153, 184, 188, 193, 202

	M12 / L = 60	60	High-grade st. steel	10...30	IP 65 / IP 67	5000	200	6	MFS210
---	--------------	----	----------------------	---------	---------------	------	-----	---	---------------

	M18 / L = 60	70	High-grade st. steel	10...30	IP 65 / IP 67	5000	200	7	MGS206
---	--------------	----	----------------------	---------	---------------	------	-----	---	---------------

M12 connector · Output function  · DC NPN · Wiring diagram no. 2 · Connector groups 148, 149, 153, 184, 188, 193, 202

	M18 / L = 60	70	High-grade st. steel	10...30	IP 65 / IP 67	5000	200	7	MGS205
---	--------------	----	----------------------	---------	---------------	------	-----	---	---------------





Position sensors

Sensors for industrial applications

Type	Dimensions [mm]	Sensing range [mm]	Material	U _b [V]	Protection	f [Hz]	I _{load} [mA]	Drawing no.	Order no.
------	--------------------	-----------------------	----------	-----------------------	------------	-----------	---------------------------	-------------	-----------

Cable 2 m · Output function · DC PNP · Wiring diagram no. 4

	M8 / L = 50	60	stainless steel (316L)	10...30	IP 67	5000	200	8	ME5011
	M12 / L = 50	60	High-grade st. steel	10...30	IP 67	5000	200	9	MFS201
	M18 / L = 50	70	stainless steel	10...30	IP 67	5000	200	10	MGS201

Cable 2 m · Output function · DC NPN · Wiring diagram no. 5

	M8 / L = 40	60	stainless steel (316L)	10...30	IP 67	5000	200	11	ME5015
	M12 / L = 50	60	High-grade st. steel	10...30	IP 67	5000	200	9	MFS202

Cable 2 m · Output function · DC PNP · Wiring diagram no. 6

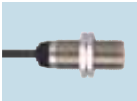
	M18 / L = 50	70	stainless steel	10...30	IP 67	5000	200	10	MGS202
---	--------------	----	-----------------	---------	-------	------	-----	----	---------------

M8 connector · Output function · DC PNP · Wiring diagram no. 1 · Connector groups 1, 2, 3, 78, 84, 145, 146

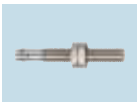
	M8 / L = 60	60	stainless steel (316L)	10...30	IP 67	5000	200	12	ME5010
---	-------------	----	------------------------	---------	-------	------	-----	----	---------------

Cable 2 m · Output function · DC PNP · Wiring diagram no. 4

	28 x 10 x 16	60	PBT	10...30	IP 67	5000	200	13	MS5011
---	--------------	----	-----	---------	-------	------	-----	----	---------------

Cable with connector 0.15 m · Output function · DC PNP · Wiring diagram no. 1 · Connector groups 1, 2, 3, 78, 84, 145, 146

	40 x 12 x 26	60	PBT	10...30	IP 67	–	200	14	MN5200
---	--------------	----	-----	---------	-------	---	-----	----	---------------

M8 connector · Output function · DC PNP · Wiring diagram no. 9 · Connector groups 1, 2, 3, 78, 84, 145, 146

	28 x 10 x 16	60	PBT	10...30	IP 67	5000	200	15	MS5013
---	--------------	----	-----	---------	-------	------	-----	----	---------------



M8 connector · Output function · DC PNP · Wiring diagram no. 1 · Connector groups 1, 2, 3, 78, 84, 145, 146

	28 x 10 x 16	60	PBT	10...30	IP 67	5000	200	15	MS5010
---	--------------	----	-----	---------	-------	------	-----	----	---------------

Full metal sensors for hygienic and wet areas

Type	Dimensions [mm]	Sensing range [mm]	Material	U _b [V]	Protection	f [Hz]	I _{load} [mA]	Drawing no.	Order no.
------	--------------------	-----------------------	----------	-----------------------	------------	-----------	---------------------------	-------------	-----------

M12 connector · Output function  · DC PNP · Wiring diagram no. 1 · Connector groups 148, 149, 150, 153, 154, 184, 188, 190, 193, 202, 203, 204

	M12 / L = 60	60	High-grade st. steel	10...30	IP 65 / IP 68 / IP 69K	5000	100	6	MFT202
	Ø 12 / L = 60	60	High-grade st. steel	10...30	IP 65 / IP 68 / IP 69K	5000	100	16	MFT204
	M18 / L = 60	70	High-grade st. steel	10...30	IP 65 / IP 68 / IP 69K	5000	100	7	MGT203

Sensors for hygienic and wet areas

Type	Dimensions [mm]	Sensing range [mm]	Material	U _b [V]	Protection	f [Hz]	I _{load} [mA]	Drawing no.	Order no.
------	--------------------	-----------------------	----------	-----------------------	------------	-----------	---------------------------	-------------	-----------

M12 connector · Output function  · DC PNP · Wiring diagram no. 1 · Connector groups 148, 149, 150, 153, 154, 184, 188, 190, 193, 202, 203, 204

	M12 / L = 60	60	High-grade st. steel	10...30	IP 65 / IP 68 / IP 69K	5000	100	6	MFT202
---	--------------	----	----------------------	---------	------------------------	------	-----	---	--------

M12 connector · Output function  · DC PNP · Wiring diagram no. 1 · Connector groups 148, 150, 153, 154, 184, 188, 190, 193









	M18 / L = 60	100	High-grade st. steel	10...30	IP 68 / IP 69K	–	200	7	MGT201
---	--------------	-----	----------------------	---------	----------------	---	-----	---	--------

Accessories damping magnets

Type	Description	Order no.
	Damping magnet · M 3.2 · Housing materials: Barium ferrite	E12537
	Damping magnet · M 6.1 · Housing materials: Neodymium	E12538
	Damping magnet · M 6.1 · Housing materials: Neodymium	E12539
	Damping magnet · M 7.0 · Housing materials: Neodymium galvanised	E12540



Position sensors

Type	Description	Order no.
	Damping magnet · M 7.1 · Housing materials: Neodymium / plastics	E12541
	Damping magnet · M 1.0 · Housing materials: Samarium cobalt	E10749
	Damping magnet · M 2.0 · Housing materials: AlNiCo	E10750
	Damping magnet · M 3.0 · Housing materials: Barium ferrite	E10751
	Damping magnet · M 3.1 · Housing materials: Barium ferrite / stainless steel	E12291
	Damping magnet · M 4.0 · Housing materials: Barium ferrite	E10752
	Damping magnet · M 4.1 · Housing materials: Barium ferrite / stainless steel	E11803
	Damping magnet · M 5.0 · Housing materials: Barium ferrite	E10753
	Damping magnet · M 5.1 · Housing materials: Barium ferrite with plastic coating / steel	E10754

Accessories mounting components

Type	Description	Order no.
	Angle bracket · for type M8 · Housing materials: stainless steel	E10734
	Angle bracket · for type M12 · Housing materials: stainless steel	E10735
	Angle bracket · for type M18 · Housing materials: stainless steel	E10736
	Mounting clamp · Ø 8 mm · Housing materials: aluminium black anodised	E10221

Type	Description	Order no.
	Mounting clamp · Ø 12 mm · with end stop · for type M12 · Housing materials: PC	E11047
	Mounting clamp · Ø 18 mm · with end stop · for type M18 · Housing materials: PC	E11048

Accessories mounting sets

Type	Description	Order no.
	Mounting set · Ø 18.5 mm · Clamp mounting · Free-standing M10 · for type OG, IG, KG · Housing materials: clamp: diecast zinc / fixture: steel	E20718
	Mounting set · Ø 18.5 mm · Clamp mounting · Free-standing M10 · for type OG, IG, KG · Housing materials: clamp: diecast zinc / fixture: steel	E20719
	Mounting set · Ø 18.5 mm · Clamp mounting · Free-standing M10 · for type OG, IG, KG · Housing materials: fixture: stainless steel 316Ti / 1.4571 / clamp: stainless steel	E20869
	Mounting set · Ø 18.5 mm · Clamp mounting · Free-standing M10 · for type OG, IG, KG · Housing materials: fixture: stainless steel 316Ti / 1.4571 / clamp: stainless steel	E20870
	Mounting set · Ø 18.5 mm · Clamp mounting · aluminium profile · for type OG, IG, KG · Housing materials: fixture: stainless steel 316Ti / 1.4571 / clamp: diecast zinc / Cube: diecast zinc	E20866
	Mounting set · Ø 18.5 mm · Clamp mounting · aluminium profile · for type OG, IG, KG · Housing materials: fixture: stainless steel 316Ti / 1.4571 / clamp: diecast zinc / Cube: diecast zinc	E20867

Wiring diagrams

Core colours

- BK black
- BN brown
- BU blue
- WH white

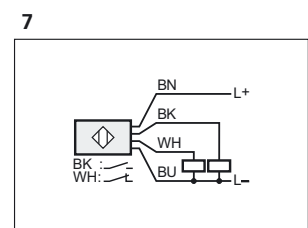
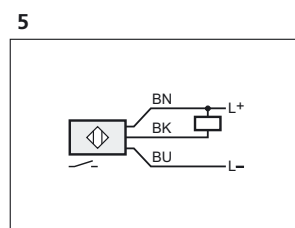
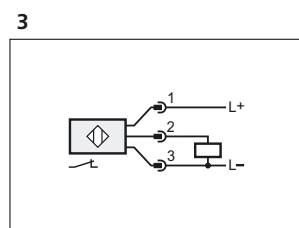
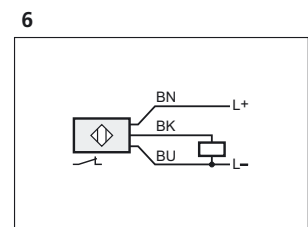
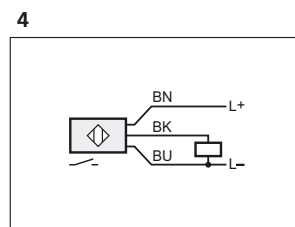
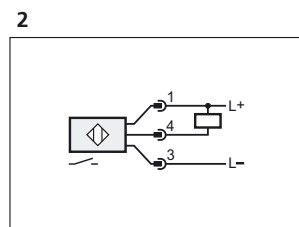
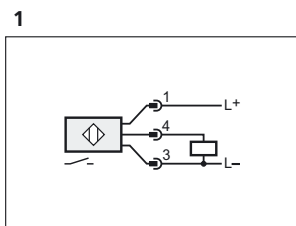



Position sensors

Wiring diagrams

8

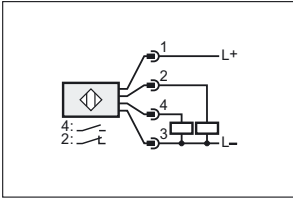

9

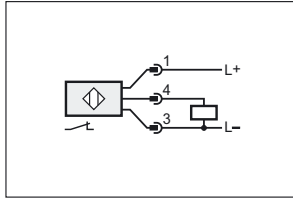

Scale drawings / drawing no. – CAD download: www.ifm.com

1

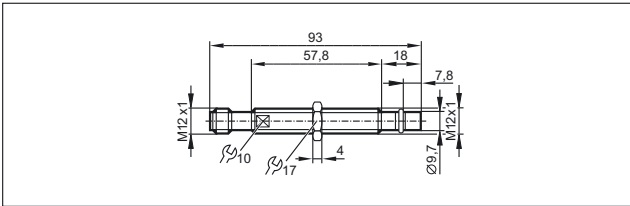

7

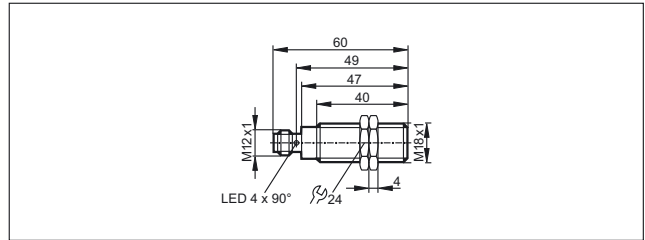

2

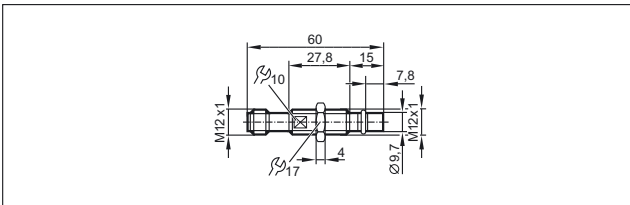

8

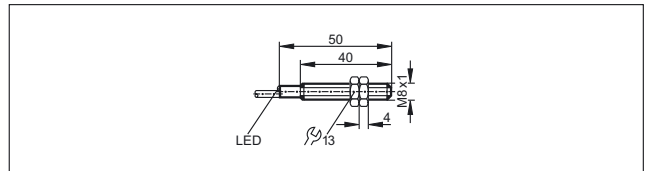

3

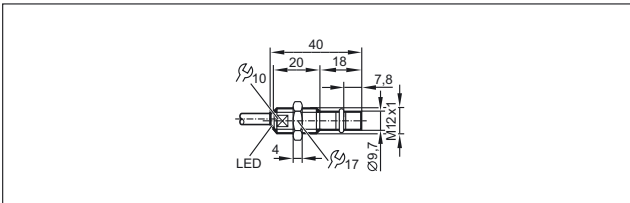

9

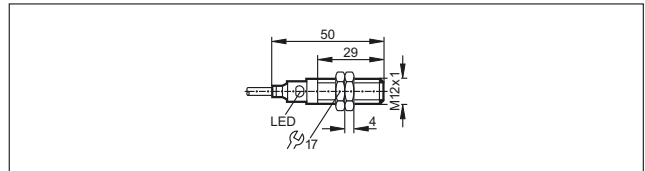

4

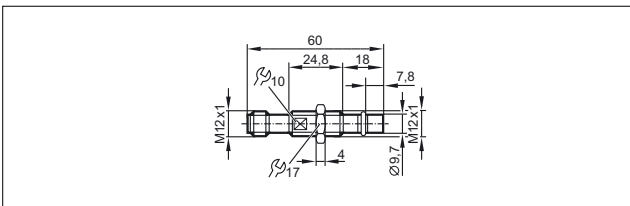

10

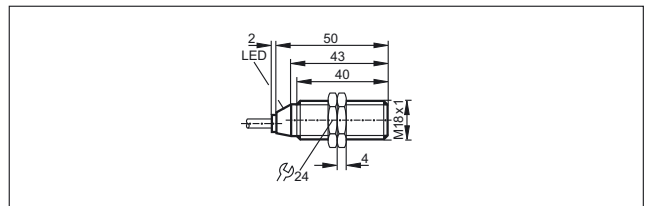

5

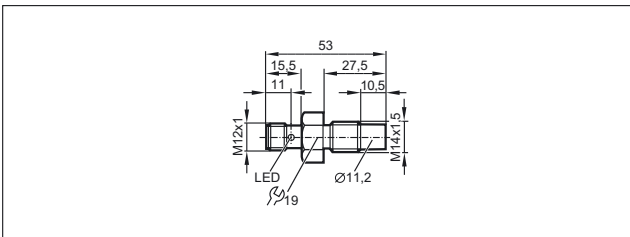

11

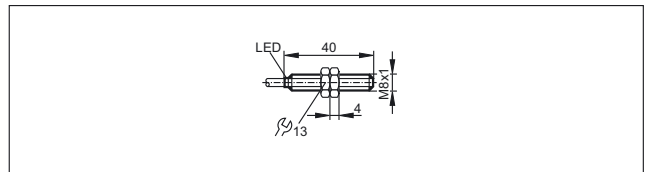

6

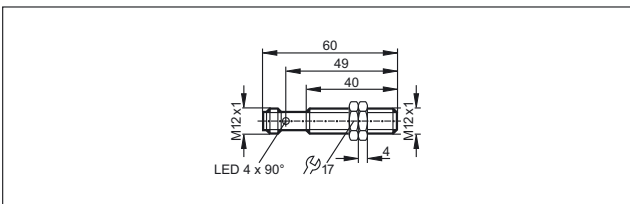

12

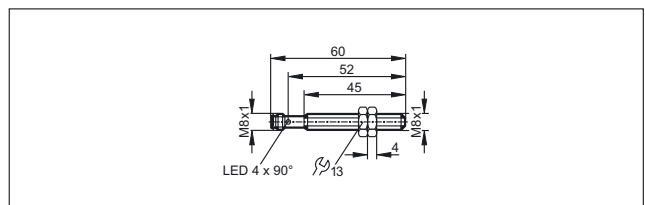

Product selectors and further information can be found at: www.ifm.com

Scale drawings / drawing no. – CAD download: www.ifm.com

13

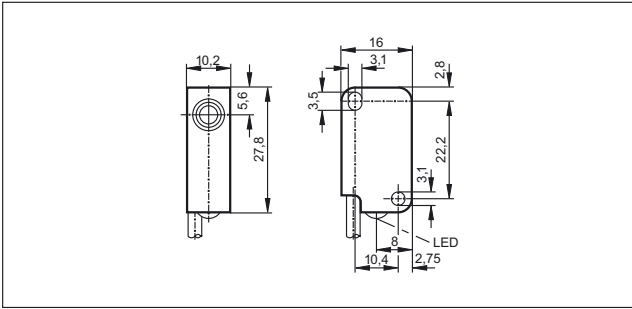

15

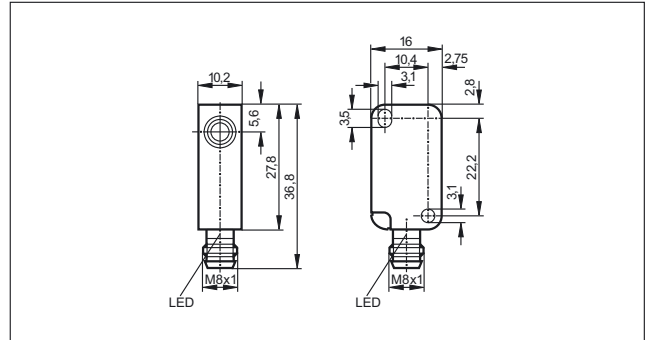

14

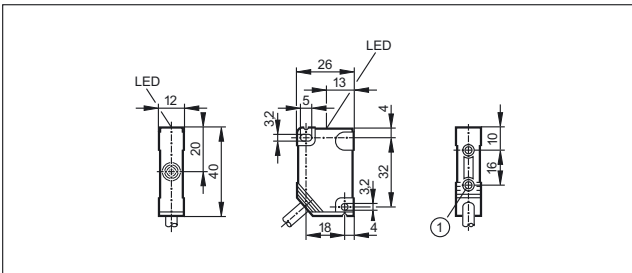

1: threaded insert M3, depth 5.8 mm, max. tightening torque 1.2 Nm (screw fixing class 8.8) when brass insert in contact with counterpart.

16

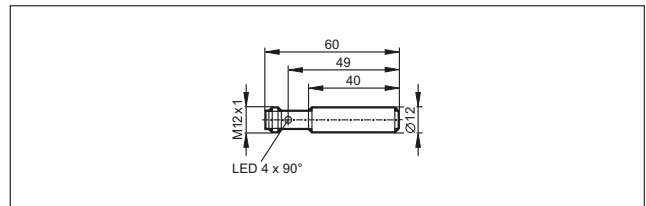



Accurate detection of the piston position in pneumatic cylinders



Cylinder sensors



Self-clamping fixture for easy adjustment and quick mounting

Convenient: Can be easily inserted from above into the slot

Suitable for almost all C- and T-slots

Unit versions available with connection cable and M8 or M12 cable plug

Wide selection of adapter accessories



Cylinder sensors



















Cylinder sensors are used for position detection of pistons in pneumatic cylinders. They are directly mounted onto the cylinder. The ring magnet attached to the piston is detected through the housing wall of non-magnetisable material (e.g. aluminium, brass or stainless steel). ifm offers a standard solution for different cylinder types and manufacturers. Moreover, a wide range of adapters and fixing accessories ensures fast and reliable installation.

System overview	Page
T-slot sensors for industrial applications	192 - 193
T-slot reed sensors for industrial applications, 2-wire	193 - 194
T-slot reed sensors for industrial applications, 3-wire	194 - 195
T-slot sensors for hygienic and wet areas	195
T-slot sensors for short-stroke cylinders	196
T-slot sensors for short-stroke cylinders for hygienic and wet areas	197
T-slot sensors with ATEX approval 1G/1D	197
T-slot sensors with ATEX approval 3D/3G	197
T-slot sensors with ATEX approval 3D	197
T-slot reed sensors with ATEX approval 1G/1D	198
T-slot reed sensors with ATEX approval 3D/3G	198
T-slot sensors for welding applications, weld-field immune	198
Two T-slot sensors on one connector	198 - 199
Non flush C-slot sensors for industrial applications	199
Flush C-slot sensors for industrial applications	200
C-slot sensors for short-stroke cylinders	200 - 201
Fixing straps for clean line cylinders	201 - 202
Clips	202 - 203
Adapters for tie rod and integrated profile	203
Adapters for trapezoidal slot cylinders	204
Various adapters and memorisation blocks	204 - 205
Wiring diagrams	205 - 206
Scale drawings / drawing no. – CAD download: www.ifm.com	206 - 209





Position sensors

T-slot sensors for industrial applications

Type	Dimensions [mm]	Material	U _b [V]	f [Hz]	Protection	I _{load} [mA]	T _a [°C]	Drawing no.	Order no.
Cable 2 m · Output function  · 3-wire · DC PNP · Wiring diagram no. 1									
	25 x 5 x 6.5	PA (polyamide)	10...30	10000	IP 65 / IP 67	100	-25...85	1	MK5100
	25 x 5 x 6.5	PA (polyamide)	10...30	10000	IP 65 / IP 67	200	-25...85	1	MK5115
Cable 2 m · Output function  · 3-wire · DC NPN · Wiring diagram no. 2									
	25 x 5 x 6.5	PA (polyamide)	10...30	10000	IP 65 / IP 67	100	-25...85	1	MK5114
Cable 2 m · Output function  · 2-wire · DC PNP/NPN · Wiring diagram no. 3									
	25 x 5 x 6.5	PA (polyamide)	10...30	4000	IP 65 / IP 67	100	-25...85	1	MK5103
Cable 6 m · Output function  · 3-wire · DC PNP · Wiring diagram no. 1									
	25 x 5 x 6.5	PA (polyamide)	10...30	10000	IP 65 / IP 67	200	-25...85	1	MK5117
Cable 10 m · Output function  · 3-wire · DC PNP · Wiring diagram no. 1									
	25 x 5 x 6.5	PA (polyamide)	10...30	10000	IP 65 / IP 67	100	-25...85	1	MK5124
Cable 0.3 m · with M8 connector (snap-fit) · Output function  · 3-wire · DC PNP · Wiring diagram no. 4 · Connector groups 1, 2, 3, 78, 84, 145, 146									
	25 x 5 x 6.5	PA (polyamide)	10...30	10000	IP 65 / IP 67	100	-25...85	2	MK5101
	25 x 5 x 6.5	PA (polyamide)	10...30	10000	IP 65 / IP 67	200	-25...85	2	MK5106
Cable 0.3 m · with M8 connector (snap-fit) · Output function  · 3-wire · DC NPN · Wiring diagram no. 5 · Connector groups 1, 3, 78, 84, 145									
	25 x 5 x 6.5	PA (polyamide)	10...30	10000	IP 65 / IP 67	100	-25...85	2	MK5112
Cable 0.3 m · with M8 connector (snap-fit) · Output function  · 2-wire · DC PNP/NPN · Wiring diagram no. 6 · Connector groups 1, 3, 145									
	25 x 5 x 6.5	PA (polyamide)	10...30	4000	IP 65 / IP 67	100	-25...85	2	MK5104

Type	Dimensions [mm]	Material	U _b [V]	f [Hz]	Protection	I _{load} [mA]	T _a [°C]	Drawing no.	Order no.
------	--------------------	----------	-----------------------	-----------	------------	---------------------------	------------------------	----------------	--------------

Cable 0.3 m · with M8 connector · Output function  · 3-wire · DC PNP · Wiring diagram no. 4 · Connector groups 1, 2, 3, 78, 84, 145, 146

	25 x 5 x 6.5	PA (polyamide)	10...30	10000	IP 65 / IP 67	100	-25...85	3	MK5102
---	--------------	----------------	---------	-------	---------------	-----	----------	---	--------

Cable 0.3 m · with M12 connector · Output function  · 3-wire · DC PNP · Wiring diagram no. 4 · Connector groups 8, 10, 11, 18, 19, 21, 23, 25, 148, 149, 150, 153, 154, 184, 188, 190, 193, 202, 203, 204

	25 x 5 x 6.5	PA (polyamide)	10...30	10000	IP 65 / IP 67	100	-25...85	4	MK5107
---	--------------	----------------	---------	-------	---------------	-----	----------	---	--------

	25 x 5 x 6.5	PA (polyamide)	10...30	10000	IP 65 / IP 67	200	-25...85	4	MK5108
---	--------------	----------------	---------	-------	---------------	-----	----------	---	--------

Cable 0.3 m · with M8 connector · Output function  · 2-wire · DC PNP/NPN · Wiring diagram no. 6 · Connector groups 1, 3, 145

	25 x 5 x 6.5	PA (polyamide)	10...30	4000	IP 65 / IP 67	100	-25...85	3	MK5105
---	--------------	----------------	---------	------	---------------	-----	----------	---	--------

Cable 0.3 m · with M12 connector · Output function  · 2-wire · DC PNP/NPN · Wiring diagram no. 6 · Connector groups 8, 10, 19, 21, 23, 25, 148, 149, 153, 184, 188, 193, 202

	25 x 5 x 6.5	PA (polyamide)	10...30	4000	IP 65 / IP 67	100	-25...85	4	MK5109
---	--------------	----------------	---------	------	---------------	-----	----------	---	--------

Cable 1 m · with M8 connector · Output function  · 3-wire · DC PNP · Wiring diagram no. 4 · Connector groups 1, 2, 3, 78, 84, 145, 146

	25 x 5 x 6.5	PA (polyamide)	10...30	10000	IP 65 / IP 67	100	-25...85	3	MK5122
---	--------------	----------------	---------	-------	---------------	-----	----------	---	--------

M8 connector · Output function  · 3-wire · DC PNP · Wiring diagram no. 4 · Connector groups 1, 2, 3, 78, 84, 145, 146

	27.5 x 18 x 15.5	PA (polyamide)	10...30	6000	IP 65 / IP 67	100	-25...85	5	MK5900
---	------------------	----------------	---------	------	---------------	-----	----------	---	--------

M8 connector · Output function  · 3-wire · DC NPN · Wiring diagram no. 5 · Connector groups 1, 3, 78, 84, 145

	27.5 x 18 x 15.5	PA (polyamide)	10...30	6000	IP 65 / IP 67	100	-25...85	5	MK5902
---	------------------	----------------	---------	------	---------------	-----	----------	---	--------

T-slot reed sensors for industrial applications, 2-wire











Type	Dimensions [mm]	Material	U _b [V]	f [Hz]	Protection	I _{load} [mA]	T _a [°C]	Drawing no.	Order no.
------	--------------------	----------	-----------------------	-----------	------------	---------------------------	------------------------	----------------	--------------

M8 connector · Output function  · 2-wire · AC/DC PNP/NPN · Wiring diagram no. 7

	27.5 x 18 x 15.5	PA (polyamide)	5...50	1000	IP 65 / IP 67	100	-25...70	5	MR0901*
---	------------------	----------------	--------	------	---------------	-----	----------	---	---------









Position sensors







Type	Dimensions [mm]	Material	U _b [V]	f [Hz]	Protection	I _{load} [mA]	T _a [°C]	Drawing no.	Order no.
Cable 2 m · Output function  · 2-wire · AC/DC PNP/NPN · Wiring diagram no. 8									
	30.5 x 5 x 6.5	PA (polyamide)	5...120	1000	IP 65 / IP 67	100	-25...70	6	MR0100*
Cable 6 m · Output function  · 2-wire · AC/DC PNP/NPN · Wiring diagram no. 8									
	30.5 x 5 x 6.5	PA (polyamide)	5...120	1000	IP 65 / IP 67	100	-25...70	6	MR0117*
Cable 0.3 m · with M8 connector (snap-fit) · Output function  · 2-wire · AC/DC PNP/NPN · Wiring diagram no. 7 · Connector groups 1, 3, 145									
	30.5 x 5 x 6.5	PA (polyamide)	5...60	1000	IP 65 / IP 67	100	-25...70	7	MR0101*
Cable 0.3 m · with M8 connector · Output function  · 2-wire · AC/DC PNP/NPN · Wiring diagram no. 7 · Connector groups 1, 3, 145									
	30.5 x 5 x 6.5	PA (polyamide)	5...60	1000	IP 65 / IP 67	100	-25...70	8	MR0102*
Cable 0.3 m · with M12 connector · Output function  · 2-wire · AC/DC PNP/NPN · Wiring diagram no. 7 · Connector groups 8, 10, 19, 21, 23, 25, 148, 149, 153, 184, 188, 193, 202									
	30.5 x 5 x 6.5	PA (polyamide)	5...60	1000	IP 65 / IP 67	100	-25...70	9	MR0107*

* Note on use of miniature fuses for electrical connection

Miniature fuse to IEC60127-2 sheet 1, ≤ 0,175 A (fast acting) Recommendation: check the unit for reliable function after a short circuit.

T-slot reed sensors for industrial applications, 3-wire







Type	Dimensions [mm]	Material	U _b [V]	f [Hz]	Protection	I _{load} [mA]	T _a [°C]	Drawing no.	Order no.
Cable 0.3 m · with M8 connector (snap-fit) · Output function  · 3-wire · AC/DC PNP · Wiring diagram no. 9 · Connector groups 1, 2, 3, 78, 84, 145, 146									
	30.5 x 5 x 6.5	PA (polyamide)	5...50	1000	IP 65 / IP 67	350 / 500	-25...70	7	MR0119*
Cable 0.3 m · with M8 connector · Output function  · 3-wire · AC/DC PNP · Wiring diagram no. 9 · Connector groups 1, 2, 3, 78, 84, 145, 146									
	30.5 x 5 x 6.5	PA (polyamide)	5...50	1000	IP 65 / IP 67	350 / 500	-25...70	8	MR0120*
Cable 2 m · Output function  · 3-wire · AC/DC PNP · Wiring diagram no. 10									
	30.5 x 5 x 6.5	PA (polyamide)	5...50	1000	IP 65 / IP 67	350 / 500	-25...70	6	MR0122*

Type	Dimensions [mm]	Material	U _b [V]	f [Hz]	Protection	I _{load} [mA]	T _a [°C]	Draw- ing no.	Order no.
Cable 6 m · Output function  · 3-wire · AC/DC PNP · Wiring diagram no. 10									
	30.5 x 5 x 6.5	PA (polyamide)	5...50	1000	IP 65 / IP 67	350 / 500	-25...70	6	MR0123*
Cable 0.3 m · with M12 connector · Output function  · 3-wire · AC/DC PNP · Wiring diagram no. 9 · Connector groups 8, 10, 11, 18, 19, 21, 23, 25, 148, 149, 150, 153, 154, 184, 188, 190, 193, 202, 203, 204									
	30.5 x 5 x 6.5	PA (polyamide)	5...50	1000	IP 65 / IP 67	350 / 500	-25...70	9	MR0121*
M8 connector · Output function  · 3-wire · AC/DC PNP · Wiring diagram no. 9									
	27.5 x 18 x 15.5	PA (polyamide)	5...50	1000	IP 65 / IP 67	350 / 500	-25...70	5	MR0902*

*** Note on use of miniature fuses for electrical connection**

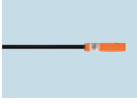
Miniature fuse to IEC60127-2 sheet 1, ≤ 0,175 A (fast acting) Recommendation: check the unit for reliable function after a short circuit.









T-slot sensors for hygienic and wet areas

Type	Dimensions [mm]	Material	U _b [V]	f [Hz]	Protection	I _{load} [mA]	T _a [°C]	Draw- ing no.	Order no.
Cable 2 m · Output function  · 3-wire · DC PNP · Wiring diagram no. 1									
	25 x 5 x 6.5	PA (polyamide)	10...30	10000	IP 65 / IP 67 / IP 69K	100	-25...85	1	MK5110
Cable 6 m · Output function  · 3-wire · DC PNP · Wiring diagram no. 1									
	25 x 5 x 6.5	PA (polyamide)	10...30	10000	IP 65 / IP 67 / IP 69K	100	-25...85	1	MK5128
Cable 0.3 m · with M12 connector · Output function  · 3-wire · DC PNP · Wiring diagram no. 4 · Connector groups 8, 10, 11, 18, 19, 21, 23, 25, 148, 149, 150, 153, 154, 184, 188, 190, 193, 202, 203, 204									
	25 x 5 x 6.5	PA (polyamide)	10...30	10000	IP 65 / IP 67 / IP 69K	100	-25...85	10	MK5111
Cable 0.3 m · with M12 connector · Output function  · 3-wire · DC NPN · Wiring diagram no. 5 · Connector groups 8, 10, 19, 21, 23, 25, 148, 149, 153, 184, 188, 193, 202									
	25 x 5 x 6.5	PA (polyamide)	10...30	6000	IP 65 / IP 67 / IP 69K	100	-25...85	11	MK5186

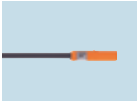

Position sensors

T-slot sensors for short-stroke cylinders

Type	Dimensions [mm]	Material	U _b [V]	f [Hz]	Protection	I _{load} [mA]	T _a [°C]	Drawing no.	Order no.
Cable 2 m · Output function  · 3-wire · DC PNP · Wiring diagram no. 1									
	25 x 5 x 6.5	PA (polyamide)	10...30	6000	IP 65 / IP 67	100	-25...85	12	MK5140
Cable 2 m · Output function  · 3-wire · DC PNP · Wiring diagram no. 11									
	25 x 5 x 6.5	PA (polyamide)	10...30	6000	IP 65 / IP 67	100	-25...85	12	MK5156
Cable 10 m · Output function  · 3-wire · DC PNP · Wiring diagram no. 1									
	25 x 5 x 6.5	PA (polyamide)	10...30	6000	IP 65 / IP 67	100	-25...85	12	MK5161
Cable 0.3 m · with M8 connector (snap-fit) · Output function  · 3-wire · DC NPN · Wiring diagram no. 5 · Connector groups 1, 3, 78, 84, 145									
	25 x 5 x 6.5	PA (polyamide)	10...30	6000	IP 65 / IP 67	100	-25...85	13	MK5137
Cable 0.3 m · with M8 connector (snap-fit) · Output function  · 3-wire · DC PNP · Wiring diagram no. 4 · Connector groups 1, 2, 3, 78, 84, 145, 146									
	25 x 5 x 6.5	PA (polyamide)	10...30	6000	IP 65 / IP 67	100	-25...85	13	MK5138
Cable 0.3 m · with M8 connector (snap-fit) · Output function  · 3-wire · DC PNP · Wiring diagram no. 12 · Connector groups 1, 2, 3, 78, 84, 145, 146									
	25 x 5 x 6.5	PA (polyamide)	10...30	6000	IP 65 / IP 67	100	-25...85	13	MK5155
Cable 0.3 m · with M8 connector · Output function  · 3-wire · DC PNP · Wiring diagram no. 4 · Connector groups 1, 2, 3, 78, 84, 145, 146									
	25 x 5 x 6.5	PA (polyamide)	10...30	6000	IP 65 / IP 67	100	-25...85	14	MK5159
Cable 0.3 m · with M12 connector · Output function  · 3-wire · DC PNP · Wiring diagram no. 4 · Connector groups 8, 10, 11, 18, 19, 21, 23, 25, 148, 149, 150, 153, 154, 184, 188, 190, 193, 202, 203, 204									
	25 x 5 x 6.5	PA (polyamide)	10...30	6000	IP 65 / IP 67	100	-25...85	15	MK5139

T-slot sensors for short-stroke cylinders for hygienic and wet areas

Type	Dimensions [mm]	Material	U _b [V]	f [Hz]	Protection	I _{load} [mA]	T _a [°C]	Drawing no.	Order no.
------	--------------------	----------	-----------------------	-----------	------------	---------------------------	------------------------	----------------	--------------

Cable 2 m · Output function  · 3-wire · DC PNP · Wiring diagram no. 1

	25 x 5 x 6.5	PA (polyamide)	10...30	6000	IP 65 / IP 67 / IP 69K	100	-25...85	12	MK5158
---	--------------	----------------	---------	------	---------------------------	-----	----------	----	--------

Cable 0.3 m · with M12 connector · Output function  · 3-wire · DC PNP · Wiring diagram no. 4 · Connector groups 8, 10, 11, 18, 19, 21, 23, 25, 148, 149, 150, 153, 154, 184, 188, 190, 193, 202, 203, 204

	25 x 5 x 6.5	PA (polyamide)	10...30	6000	IP 65 / IP 67 / IP 69K	100	-25...85	11	MK5157
---	--------------	----------------	---------	------	---------------------------	-----	----------	----	--------

T-slot sensors with ATEX approval 1G/1D

Type	Dimensions [mm]	Material	U _b [V]	f [Hz]	Protection	I _{load} [mA]	T _a [°C]	Drawing no.	Order no.
------	--------------------	----------	-----------------------	-----------	------------	---------------------------	------------------------	----------------	--------------

Cable 6 m · Output function  · 2-wire · Connection to certified intrinsically safe circuits with the max. values U = 15 V / I = 50 mA / P = 120 mW · Wiring diagram no. 3

	25 x 5 x 6.5	PA (polyamide)	–	2000	IP 65 / IP 67	–	-25...70	12	MK502A
---	--------------	----------------	---	------	---------------	---	----------	----	--------

T-slot sensors with ATEX approval 3D/3G

Type	Dimensions [mm]	Material	U _b [V]	f [Hz]	Protection	I _{load} [mA]	T _a [°C]	Drawing no.	Order no.
------	--------------------	----------	-----------------------	-----------	------------	---------------------------	------------------------	----------------	--------------

Cable 6 m · Output function  · 3-wire · DC PNP · Wiring diagram no. 1

	25 x 5 x 6.5	PA (polyamide)	10...30	6000	IP 65 / IP 67	100	-20...60	12	MK503A
---	--------------	----------------	---------	------	---------------	-----	----------	----	--------

T-slot sensors with ATEX approval 3D

Type	Dimensions [mm]	Material	U _b [V]	f [Hz]	Protection	I _{load} [mA]	T _a [°C]	Drawing no.	Order no.
------	--------------------	----------	-----------------------	-----------	------------	---------------------------	------------------------	----------------	--------------

Cable 2 m · Output function  · 3-wire · DC PNP · Wiring diagram no. 1

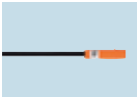
	25 x 5 x 6.5	PA (polyamide)	10...30	10000	IP 65 / IP 67	100	-25...60	1	MK500A
---	--------------	----------------	---------	-------	---------------	-----	----------	---	--------

Cable 0.3 m · with M12 connector · Output function  · 3-wire · DC PNP · Wiring diagram no. 4 · Connector groups 196, 198

	25 x 5 x 6.5	PA (polyamide)	10...30	10000	IP 65 / IP 67	100	-25...60	10	MK501A
---	--------------	----------------	---------	-------	---------------	-----	----------	----	--------



Position sensors

T-slot reed sensors with ATEX approval 1G/1D

Type	Dimensions [mm]	Material	U _b [V]	f [Hz]	Protection	I _{load} [mA]	T _a [°C]	Drawing no.	Order no.
------	--------------------	----------	-----------------------	-----------	------------	---------------------------	------------------------	----------------	--------------

Cable 6 m · Output function  · 2-wire · Connection to certified intrinsically safe circuits with the max. values U = 15 V / I = 50 mA / P = 120 mW · Wiring diagram no. 3

	30.5 x 5 x 6.5	PA (polyamide)	-	-	IP 65 / IP 67	-	-25...70	6	MR500A
---	----------------	----------------	---	---	---------------	---	----------	---	--------

T-slot reed sensors with ATEX approval 3D/3G

Type	Dimensions [mm]	Material	U _b [V]	f [Hz]	Protection	I _{load} [mA]	T _a [°C]	Drawing no.	Order no.
------	--------------------	----------	-----------------------	-----------	------------	---------------------------	------------------------	----------------	--------------

Cable 6 m · Output function  · 2-wire · DC PNP/NPN · Wiring diagram no. 13

	30.5 x 5 x 6.5	PA (polyamide)	5...30	-	IP 65 / IP 67	100	-20...60	6	MR501A*
---	----------------	----------------	--------	---	---------------	-----	----------	---	---------

* Note on use of miniature fuses for electrical connection

Miniature fuse to IEC60127-2 sheet 1, ≤ 0,175 A (fast acting) Recommendation: check the unit for reliable function after a short circuit.

T-slot sensors for welding applications, weld-field immune

Type	Dimensions [mm]	Material	U _b [V]	f [Hz]	Protection	I _{load} [mA]	T _a [°C]	Drawing no.	Order no.
------	--------------------	----------	-----------------------	-----------	------------	---------------------------	------------------------	----------------	--------------

Cable 0.3 m · with M12 connector · Output function  · 3-wire · DC PNP · Wiring diagram no. 4 · Connector groups 137, 138, 139, 140, 141

	25 x 5 x 6.5	PA (polyamide)	10...30	9	IP 65 / IP 67	100	-25...85	4	MK5214
---	--------------	----------------	---------	---	---------------	-----	----------	---	--------

Cable 0.3 m · with M8 connector · Output function  · 3-wire · DC PNP · Wiring diagram no. 4

	25 x 5 x 6.5	PA (polyamide)	10...30	9	IP 65 / IP 67	100	-25...85	3	MK5215
---	--------------	----------------	---------	---	---------------	-----	----------	---	--------

Two T-slot sensors on one connector

Type	Dimensions [mm]	Material	U _b [V]	f [Hz]	Protection	I _{load} [mA]	T _a [°C]	Drawing no.	Order no.
------	--------------------	----------	-----------------------	-----------	------------	---------------------------	------------------------	----------------	--------------

Cable 0.3 m · with M8 connector · Output function  · 4-wire · DC PNP · Wiring diagram no. 14 · Connector groups 4, 5, 80, 86, 147

	25 x 5 x 6.5	PA (polyamide)	10...30	6000	IP 65 / IP 67	100	-25...85	16	MK5208
---	--------------	----------------	---------	------	---------------	-----	----------	----	--------

Type	Dimensions [mm]	Material	U _b [V]	f [Hz]	Protection	I _{load} [mA]	T _a [°C]	Drawing no.	Order no.
------	--------------------	----------	-----------------------	-----------	------------	---------------------------	------------------------	----------------	--------------

Cable 0.3 m · with M12 connector · Output function  · 4-wire · DC PNP · Wiring diagram no. 14 · Connector groups 8, 9, 10, 11, 18, 19, 21, 23, 25, 148, 149, 150, 151, 153, 154, 184, 188, 190, 193, 202, 203, 204



25 x 5 x 6.5 PA (polyamide) 10...30 6000 IP 65 / IP 67 100 -25...85 17 MK5209

Non flush C-slot sensors for industrial applications

Type	Dimensions [mm]	Material	U _b [V]	f [Hz]	Protection	I _{load} [mA]	T _a [°C]	Drawing no.	Order no.
------	--------------------	----------	-----------------------	-----------	------------	---------------------------	------------------------	----------------	--------------

Cable 2 m · Output function  · 3-wire · DC PNP · Wiring diagram no. 1

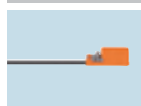

17.5 x 2.8 x 7.7 PA (polyamide) 10...30 10000 IP 65 / IP 67 100 -25...85 18 MK5300

Cable 2 m · Output function  · 3-wire · DC NPN · Wiring diagram no. 2

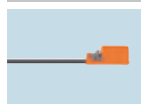

17.5 x 2.8 x 7.7 PA (polyamide) 10...30 10000 IP 65 / IP 67 100 -25...85 18 MK5306

Cable 0.3 m · with M8 connector (snap-fit) · Output function  · 3-wire · DC PNP · Wiring diagram no. 4 · Connector groups 1, 2, 3, 78, 84, 145, 146



17.5 x 2.8 x 7.7 PA (polyamide) 10...30 10000 IP 65 / IP 67 100 -25...85 19 MK5301

Cable 0.3 m · with M8 connector (snap-fit) · Output function  · 3-wire · DC NPN · Wiring diagram no. 5 · Connector groups 1, 3, 78, 84, 145



17.5 x 2.8 x 7.7 PA (polyamide) 10...30 10000 IP 65 / IP 67 100 -25...85 19 MK5307

Cable 0.3 m · with M8 connector · Output function  · 3-wire · DC PNP · Wiring diagram no. 4 · Connector groups 1, 2, 3, 78, 84, 145, 146

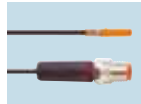

17.5 x 2.8 x 7.7 PA (polyamide) 10...30 10000 IP 65 / IP 67 100 -25...85 20 MK5302

Cable 0.5 m · with M8 connector · Output function  · 3-wire · DC PNP · Wiring diagram no. 4 · Connector groups 1, 2, 3, 78, 84, 145, 146

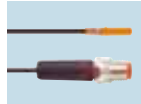

17.5 x 2.8 x 7.7 PA (polyamide) 10...30 10000 IP 65 / IP 67 100 -25...85 20 MK5305

Cable 0.3 m · with M12 connector · Output function  · 3-wire · DC PNP · Wiring diagram no. 4 · Connector groups 8, 10, 11, 18, 19, 21, 23, 25, 148, 149, 150, 153, 154, 184, 188, 190, 193, 202, 203, 204

















17.5 x 2.8 x 7.7 PA (polyamide) 10...30 10000 IP 65 / IP 67 100 -25...85 21 MK5304













Position sensors

Flush C-slot sensors for industrial applications

Type	Dimensions [mm]	Material	U _b [V]	f [Hz]	Protection	I _{load} [mA]	T _a [°C]	Drawing no.	Order no.
Cable 2 m · Output function  · 3-wire · DC PNP · Wiring diagram no. 1									
	26.1 x 2.8 x 5.5	PA (polyamide)	10...30	10000	IP 65 / IP 67	100	-25...85	22	MK5312
Cable 2 m · Output function  · 3-wire · DC NPN · Wiring diagram no. 2									
	26.1 x 2.8 x 5.5	PA (polyamide)	10...30	10000	IP 65 / IP 67	100	-25...85	22	MK5309
Cable 0.3 m · with M8 connector (snap-fit) · Output function  · 3-wire · DC PNP · Wiring diagram no. 4 · Connector groups 1, 2, 3, 78, 84, 145, 146									
	26.1 x 2.8 x 5.5	PA (polyamide)	10...30	10000	IP 65 / IP 67	100	-25...85	23	MK5310
Cable 0.3 m · with M8 connector · Output function  · 3-wire · DC PNP · Wiring diagram no. 4 · Connector groups 1, 2, 3, 78, 84, 145, 146									
	26.1 x 2.8 x 5.5	PA (polyamide)	10...30	10000	IP 65 / IP 67	100	-25...85	24	MK5311
Cable 0.3 m · with M12 connector · Output function  · 3-wire · DC PNP · Wiring diagram no. 4 · Connector groups 8, 10, 11, 18, 19, 21, 23, 25, 148, 149, 150, 153, 154, 184, 188, 190, 193, 202, 203, 204									
	26.1 x 2.8 x 5.5	PA (polyamide)	10...30	10000	IP 65 / IP 67	100	-25...85	25	MK5314
Cable 0.3 m · with M8 connector (snap-fit) · Output function  · 3-wire · DC NPN · Wiring diagram no. 5 · Connector groups 1, 3, 78, 84, 145									
	26.1 x 2.8 x 5.5	PA (polyamide)	10...30	10000	IP 65 / IP 67	100	-25...85	23	MK5308
Cable 0.5 m · with M8 connector · Output function  · 3-wire · DC PNP · Wiring diagram no. 4 · Connector groups 1, 2, 3, 78, 84, 145, 146									
	26.1 x 2.8 x 5.5	PA (polyamide)	10...30	10000	IP 65 / IP 67	100	-25...85	26	MK5315

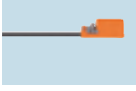
C-slot sensors for short-stroke cylinders

Type	Dimensions [mm]	Material	U _b [V]	f [Hz]	Protection	I _{load} [mA]	T _a [°C]	Drawing no.	Order no.
Cable 2 m · Output function  · 3-wire · DC PNP · Wiring diagram no. 1									
	26.1 x 2.8 x 5.5	PA (polyamide)	10...30	5000	IP 65 / IP 67	100	-25...85	22	MK5325

Type	Dimensions [mm]	Material	U _b [V]	f [Hz]	Protection	I _{load} [mA]	T _a [°C]	Drawing no.	Order no.
Cable 0.3 m · with M8 connector (snap-fit) · Output function  · 3-wire · DC PNP · Wiring diagram no. 4 · Connector groups 1, 2, 3, 78, 84, 145, 146									
	26.1 x 2.8 x 5.5	PA (polyamide)	10...30	5000	IP 65 / IP 67	100	-25...85	23	MK5326
Cable 0.3 m · with M8 connector · Output function  · 3-wire · DC PNP · Wiring diagram no. 4 · Connector groups 1, 2, 3, 78, 84, 145, 146									
	25.8 x 2.8 x 5	PA (polyamide)	10...30	5000	IP 65 / IP 67	100	-25...85	27	MK5328
Cable 2 m · Output function  · 3-wire · DC PNP · Wiring diagram no. 1									
	17.5 x 2.8 x 7.7	PA (polyamide)	10...30	5000	IP 65 / IP 67	100	-25...85	28	MK5329
Cable 0.3 m · with M8 connector (snap-fit) · Output function  · 3-wire · DC PNP · Wiring diagram no. 4 · Connector groups 1, 2, 3, 78, 84, 145, 146									
	17.5 x 2.8 x 7.7	PA (polyamide)	10...30	5000	IP 65 / IP 67	100	-25...85	29	MK5330
Cable 0.3 m · with M8 connector · Output function  · 3-wire · DC PNP · Wiring diagram no. 4 · Connector groups 1, 2, 3, 78, 84, 145, 146									
	17.5 x 2.8 x 7.7	PA (polyamide)	10...30	5000	IP 65 / IP 67	100	-25...85	30	MK5331

Fixing straps for clean line cylinders

Type	Description	Order no.
	Fixing strap for clean-line cylinders · Piston diameter 8...12 mm · for type MKT · Housing materials: adapter: PA / Fixing strap: stainless steel	E11816
	Fixing strap for clean-line cylinders · Piston diameter 16...20 mm · for type MKT · Housing materials: adapter: PA / Fixing strap: stainless steel	E11817
	Fixing strap for clean-line cylinders · Piston diameter 25...32 mm · for type MKT · Housing materials: adapter: PA / Fixing strap: stainless steel	E11818
	Fixing strap for clean-line cylinders · Piston diameter 40 mm · for type MKT · Housing materials: adapter: PA / Fixing strap: stainless steel	E11819
	Fixing strap for clean-line cylinders · Piston diameter 50 mm · for type MKT · Housing materials: adapter: PA / Fixing strap: stainless steel	E11820
	Fixing strap for clean-line cylinders · Piston diameter 63 mm · for type MKT · Housing materials: adapter: PA / Fixing strap: stainless steel	E11821



Position sensors

Type	Description	Order no.
	Fixing strap for clean-line cylinders · Piston diameter 80 mm · for type MKT · Housing materials: adapter: PA / Fixing strap: stainless steel	E11822
	Fixing strap for clean-line cylinders · Piston diameter 100 mm · for type MKT · Housing materials: adapter: PA / Fixing strap: stainless steel	E11823
	Fixing strap for clean-line cylinders · Piston diameter 10...16 mm · for type MKT · Housing materials: adapter: stainless steel / Fixing strap: stainless steel	E11975
	Fixing strap for clean-line cylinders · Piston diameter 20...25 mm · for type MKT · Housing materials: adapter: stainless steel / Fixing strap: stainless steel	E11976
	Fixing strap for clean-line cylinders · Piston diameter 32 mm · for type MKT · Housing materials: adapter: stainless steel / Fixing strap: stainless steel	E11977
	Fixing strap for clean-line cylinders · Piston diameter 40 mm · for type MKT · Housing materials: adapter: stainless steel / Fixing strap: stainless steel	E11978
	Fixing strap for clean-line cylinders · Piston diameter 50 mm · for type MKT · Housing materials: adapter: stainless steel / Fixing strap: stainless steel	E11979
	Fixing strap for clean-line cylinders · Piston diameter 63 mm · for type MKT · Housing materials: adapter: stainless steel / Fixing strap: stainless steel	E11980
	Fixing strap for clean-line cylinders · Piston diameter 80 mm · for type MKT · Housing materials: adapter: stainless steel / Fixing strap: stainless steel	E11981
	Fixing strap for clean-line cylinders · Piston diameter 100 mm · for type MKT · Housing materials: adapter: stainless steel / Fixing strap: stainless steel	E11982
	Adapter for clean-line cylinders · for types MKT (T-slot cylinder sensors) · Housing materials: PA	E11846
	Adapter for clean-line cylinders · for types MKT (T-slot cylinder sensors) · Housing materials: stainless steel	E11877

Clips

Type	Description	Order no.
	Clip · for types MKT (T-slot cylinder sensors) · Piston diameter 12 mm · Housing materials: POM / fixture: aluminium / screw: stainless steel	E11961
	Clip · for types MKT (T-slot cylinder sensors) · Piston diameter 16 mm · Housing materials: POM / fixture: aluminium / screw: stainless steel	E11958

Type	Description	Order no.
	Clip · for types MKT (T-slot cylinder sensors) · Piston diameter 20 mm · Housing materials: POM / fixture: aluminium / screw: stainless steel	E11959
	Clip · for types MKT and MKI (T-slot cylinder sensors) · Piston diameter 25 mm · Housing materials: POM / fixture: aluminium / screw: stainless steel	E11960
	Clip · for types MKT (T-slot cylinder sensors) · Clamping range 44-45 mm · Piston diameter 40 mm · Housing materials: POM / fixture: aluminium / screw: stainless steel	E12015
	Clip · for types MKT (T-slot cylinder sensors) · Clamping range 35-36 mm · Piston diameter 32 mm · Housing materials: POM / fixture: aluminium / screw: stainless steel	E12017



Adapters for tie rod and integrated profile

Type	Description	Order no.
	Adapter for tie rod / integrated profile cylinders · for types MKT (T-slot cylinder sensors) · Clamping range 5...11 mm · Housing materials: aluminium / screw: stainless steel	E11797
	Adapter for tie rod / integrated profile cylinders · for types MKT (T-slot cylinder sensors) · Clamping range 9...15 mm · Housing materials: aluminium / screw: stainless steel	E11799
	Adapter for tie rod / integrated profile cylinders · for types MKT (T-slot cylinder sensors) · Clamping range 14...20 mm · Housing materials: aluminium / screw: stainless steel	E11801
	Adapter for tie rod cylinders (or cylinders of the same dimensions) · for types MKT (T-slot cylinder sensors) · Clamping range 3...7 mm · Housing materials: aluminium / screw: stainless steel	E11913
	Adapter for tie rod cylinders (or cylinders of the same dimensions) · for types MKT (T-slot cylinder sensors) · Clamping range 5...7 mm · Housing materials: aluminium / screw: stainless steel	E11912
	Adapter for tie rod / integrated profile cylinders · for types MKT (T-slot cylinder sensors) · Clamping range 5...11 mm · Housing materials: aluminium / screw: stainless steel	E12231
	Adapter for tie rod / integrated profile cylinders · for types MKT (T-slot cylinder sensors) · Clamping range 9...13.5 mm · Housing materials: aluminium / screw: stainless steel	E12232
	Adapter for tie rod / integrated profile cylinders · for types MKT (T-slot cylinder sensors) · Clamping range 9...17 mm · Housing materials: aluminium / screw: stainless steel	E12233
	Adapter for tie rod / integrated profile cylinders · for types MKT (T-slot cylinder sensors) · Clamping range 13...15 mm · Housing materials: aluminium / screw: stainless steel	E12234







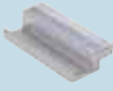

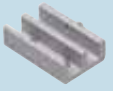

Position sensors





Adapters for trapezoidal slot cylinders

Type	Description	Order no.
	Adapter for trapezoidal slot cylinders · for types MKT (T-slot cylinder sensors) · Housing materials: aluminium alloy / set screw: stainless steel	E11796
	Adapter for trapezoidal slot cylinders · for types MKT (T-slot cylinder sensors) · Housing materials: aluminium alloy / set screw: stainless steel	E11957
	Adapter for trapezoidal slot cylinders · for types MKT (T-slot cylinder sensors) · Housing materials: aluminium alloy / set screw: stainless steel	E11988
	Adapter for Pneumax cylinders 1500 series (or cylinders of the same dimensions) · for types MKT / MRT (T-slot cylinder sensors) · Housing materials: aluminium	E12375

Various adapters and memorisation blocks

Type	Description	Order no.
	Adapter for Bosch Rexroth cylinders ICL series and Festo cylinders type CDN · for types MKT (T-slot cylinder sensors) · Housing materials: adapter: aluminium anodised / screw: stainless steel	E12164
	Adapter for Bosch-Rexroth cylinders PRA / PRB series (or cylinders of the same dimensions) · for types MKT (T-slot cylinder sensors) · Housing materials: aluminium / screw: stainless steel	E11892
	Adapter for Bosch-Rexroth cylinders 523 series (or cylinders of the same dimensions) · for types MKT (T-slot cylinder sensors) · L-slot · Housing materials: aluminium / screw: stainless steel	E11894
	Adapter for SMC cylinders ECDQ2 series (or cylinders of the same dimensions) · for types MKT (T-slot cylinder sensors) · T-slot rail, flat · Housing materials: aluminium / screw: stainless steel	E11890
	Adapter for SMC cylinders CDQ2 series (or cylinders of the same dimensions) · for types MKT (T-slot cylinder sensors) · T-slot rail, high · Housing materials: aluminium / screw: stainless steel	E11891
	Adapter for SMC cylinder CP95 · for types MKT (T-slot cylinder sensors) · Housing materials: stainless steel	E11872
	Adapter for Festo cylinders type DZH (or cylinders of the same dimensions) · for types MKT (T-slot cylinder sensors) · Housing materials: aluminium / screw: stainless steel	E11895
	Adapter for Norgren cylinders of the M series · for types MKT (T-slot cylinder sensors) · Housing materials: stainless steel	E12218
	Protective adapter for T-slot cylinder sensors · for types MKT (T-slot cylinder sensors) · Housing materials: diecast zinc coated / screws: stainless steel	E12259

Product selectors and further information can be found at: www.ifm.com

Type	Description	Order no.
	T-slot adapter for C-slot sensor · for types MKC (C-slot cylinder sensor) for installation in T-slot cylinders · (height 5 mm) · Housing materials: diecast zinc / fixing element: stainless steel	E11928
	T-slot adapter for C-slot sensor · for types MKC (C-slot cylinder sensor) for installation in T-slot cylinders · (height 7.7 mm) · Housing materials: diecast zinc / fixing element: stainless steel	E11914
	T-slot cylinder memorisation block · for types MKT (T-slot cylinder sensors) · Housing materials: PA / stainless steel	E11798
	C-slot cylinder memorisation block · for types MKC (C-slot cylinder sensors) · Housing materials: PA / stainless steel	E12004

Wiring diagrams

Core colours

- BK black
- BN brown
- BU blue

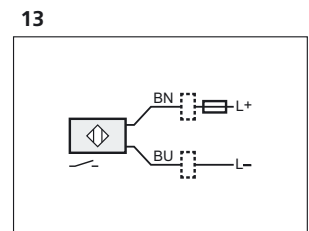
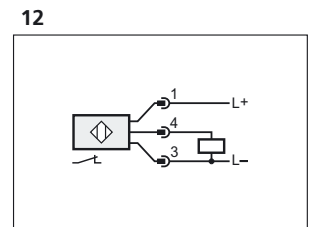
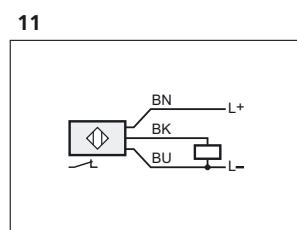
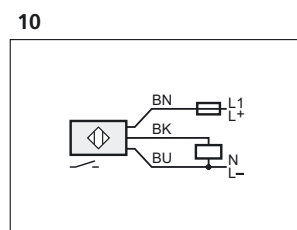
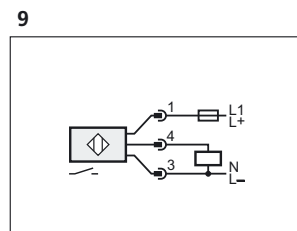
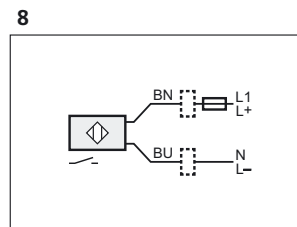
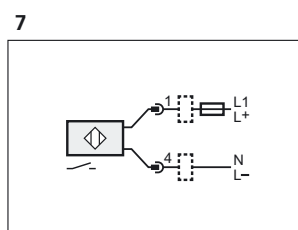
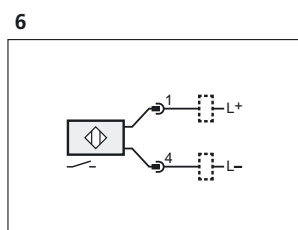
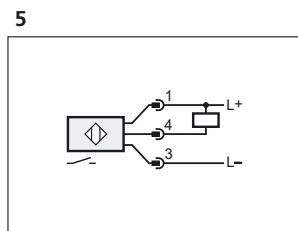
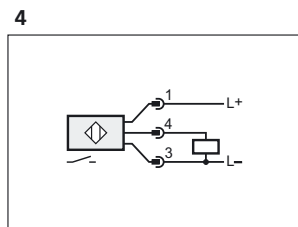
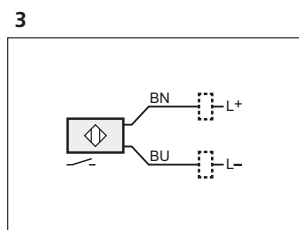
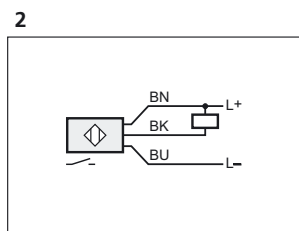
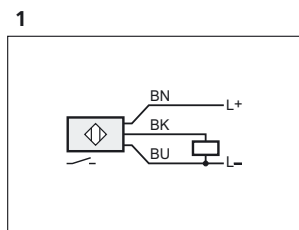

Note: miniature fuse to IEC60127-2 sheet 1, ≤ 0,175 A (fast acting)



Position sensors

Wiring diagrams

14

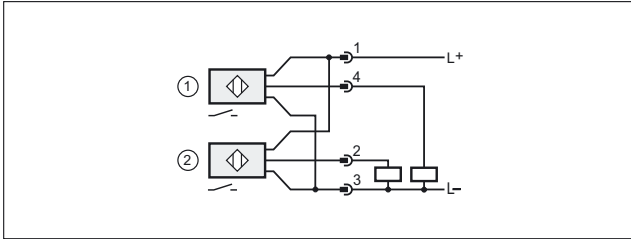

1: sensor 1, 2: sensor 2

Scale drawings / drawing no. – CAD download: www.ifm.com

1

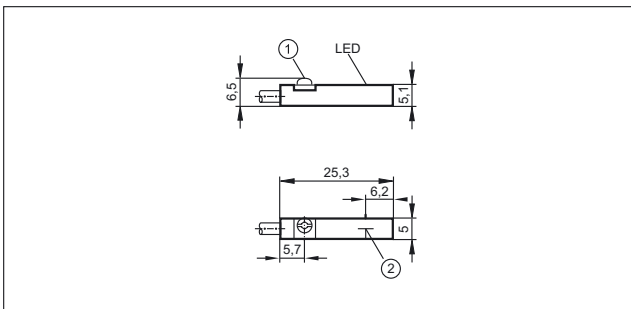

1: Fastening clamp, 2: sensing face

4

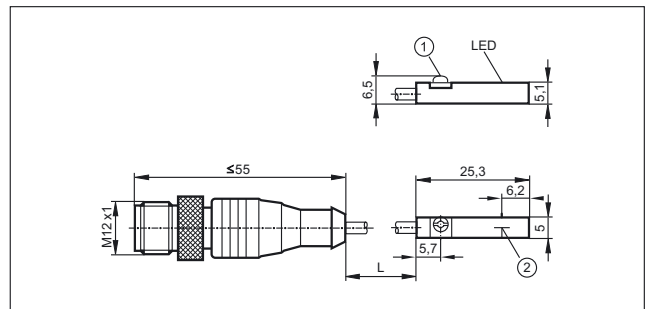

1: Fastening clamp, 2: sensing face

2

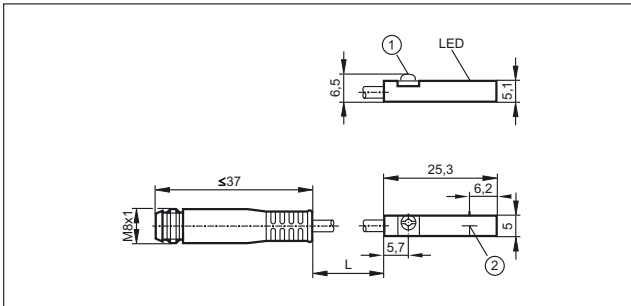

1: Fastening clamp, 2: sensing face

5

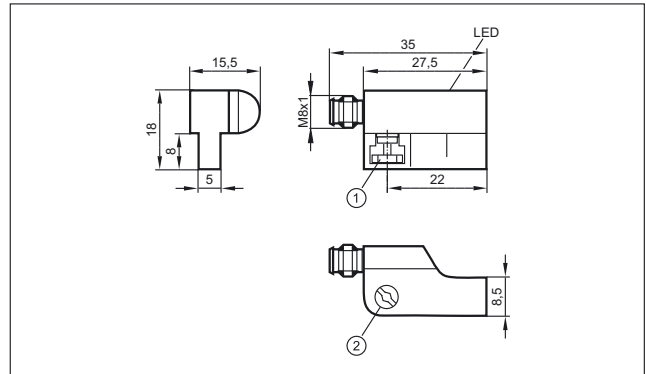

1: fixing element, 2: combined head screw for fixing element

3

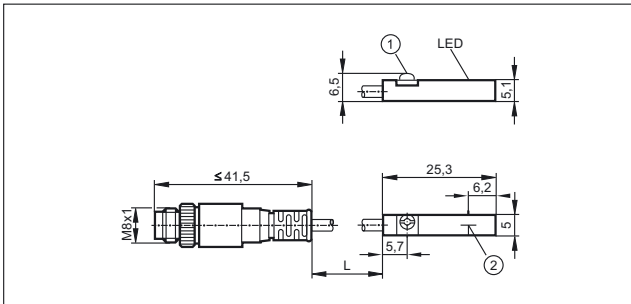

1: Fastening clamp, 2: sensing face

6

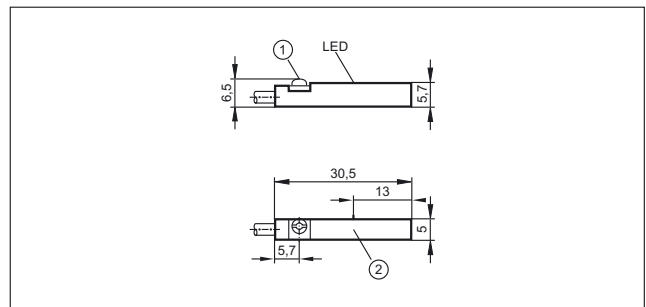

1: Clamping screw with combined slot/hexagon socket head AF 1.5, 2: sensing face

Scale drawings / drawing no. – CAD download: www.ifm.com

7

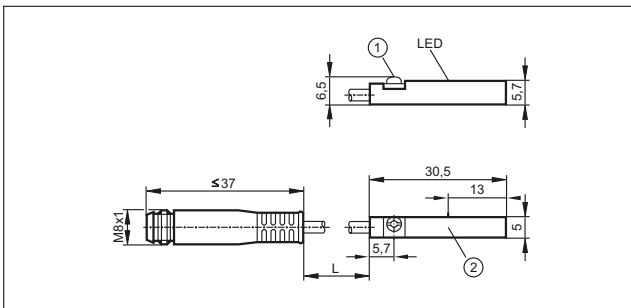

1: Clamping screw with combined slot/hexagon socket head AF 1.5, 2: sensing face

8

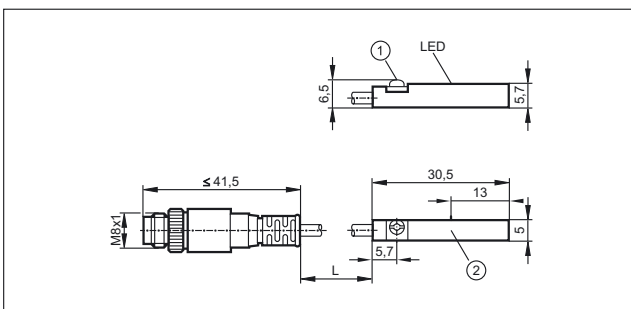

1: Clamping screw with combined slot/hexagon socket head AF 1.5, 2: sensing face

9

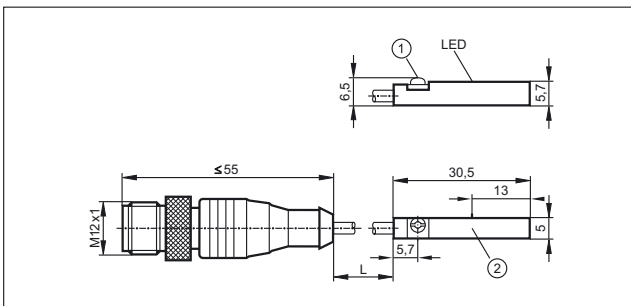

1: Clamping screw with combined slot/hexagon socket head AF 1.5, 2: sensing face

10

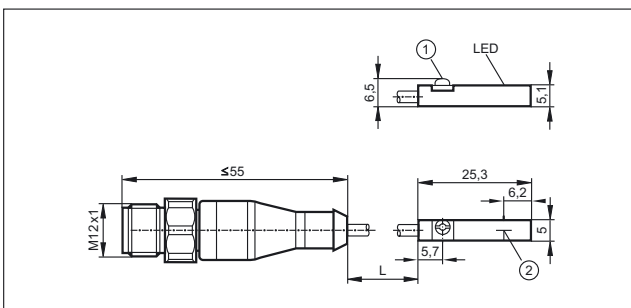

1: Fastening clamp, 2: sensing face

11

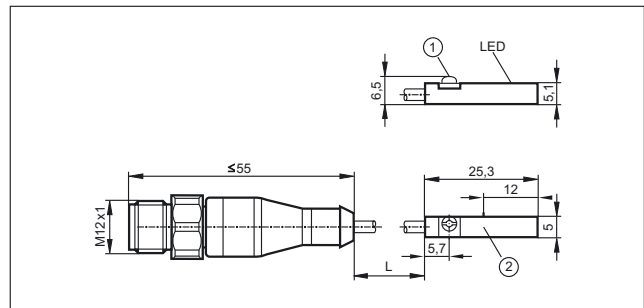

1: Fastening clamp, 2: sensing face

12

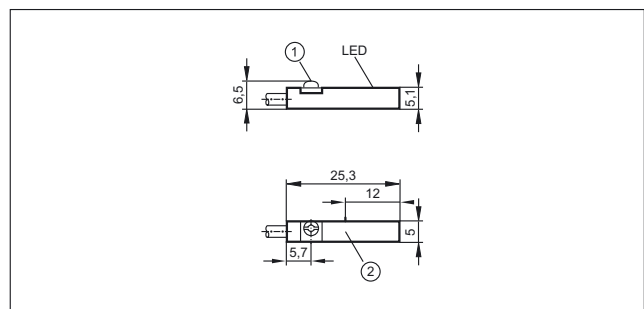

1: Fastening clamp, 2: sensing face

13

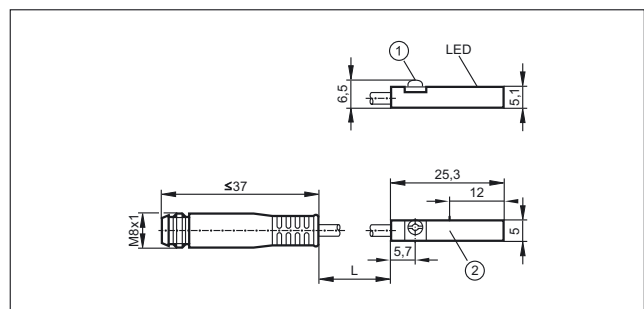

1: Fastening clamp, 2: sensing face

14

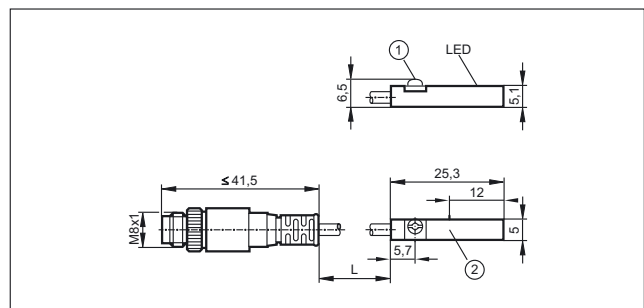

1: Fastening clamp, 2: sensing face



Position sensors

Scale drawings / drawing no. – CAD download: www.ifm.com

15

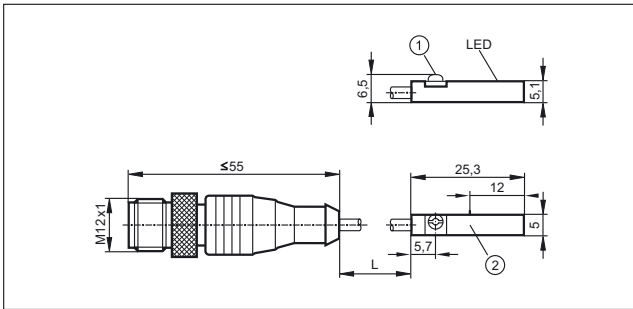

1: Fastening clamp, 2: sensing face

16

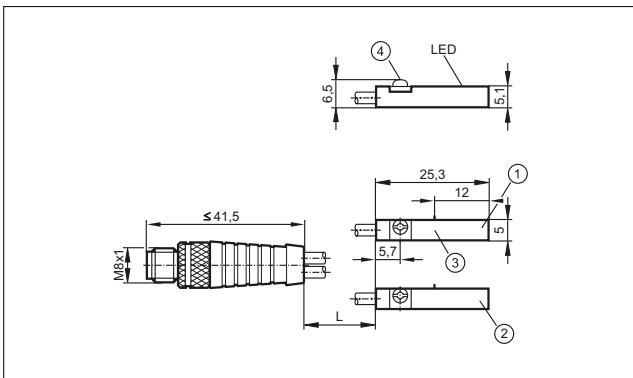

1: sensor 1, 2: sensor 2, 3: sensing face, 4: Fastening clamp

17

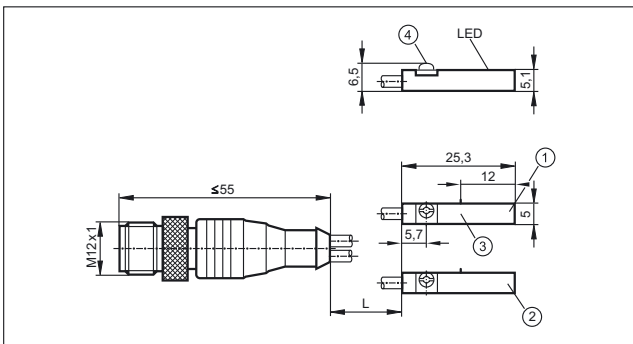

1: sensor 1, 2: sensor 2, 3: sensing face, 4: Fastening clamp

18

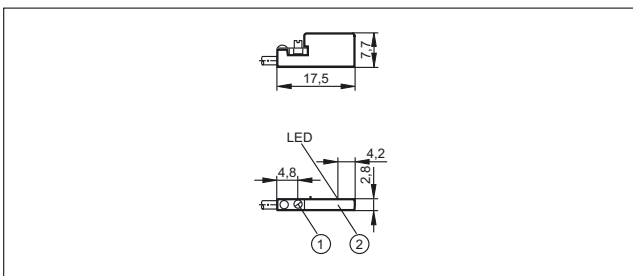

1: Fastening clamp, 2: sensing face

19

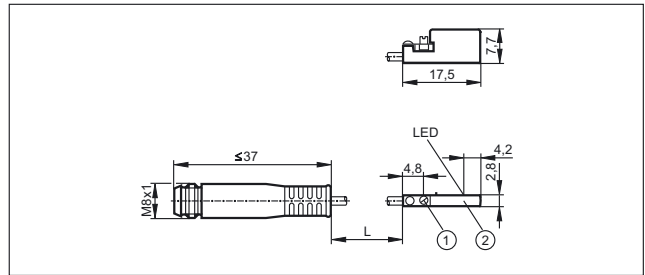

1: Fastening clamp, 2: sensing face

20

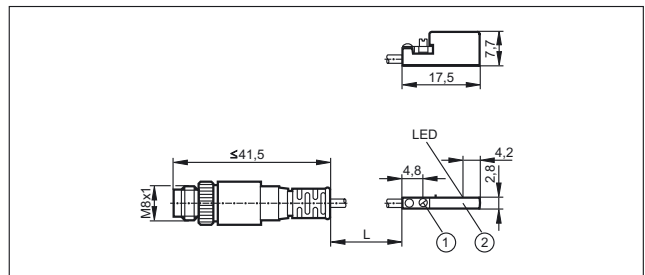

1: Fastening clamp, 2: sensing face

21

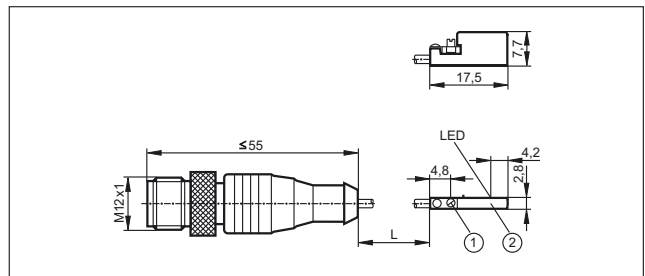

1: Fastening clamp, 2: sensing face

22

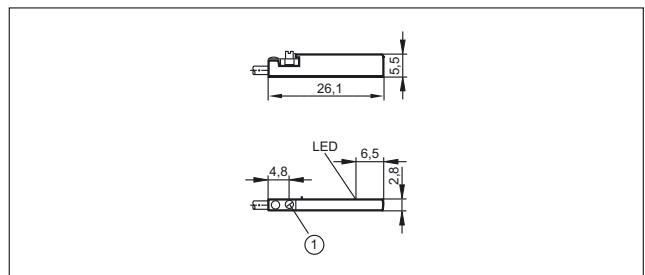

1: Fastening clamp

23

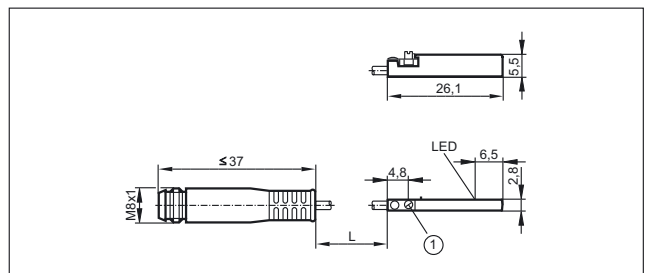

1: Fastening clamp

Scale drawings / drawing no. – CAD download: www.ifm.com

24

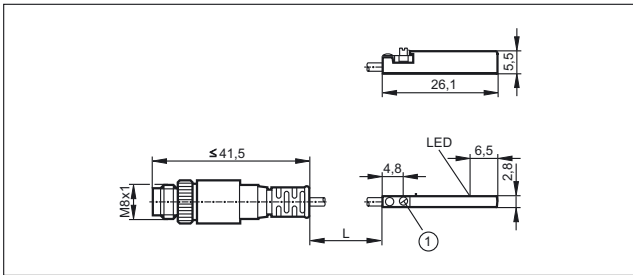

1: Fastening clamp

28

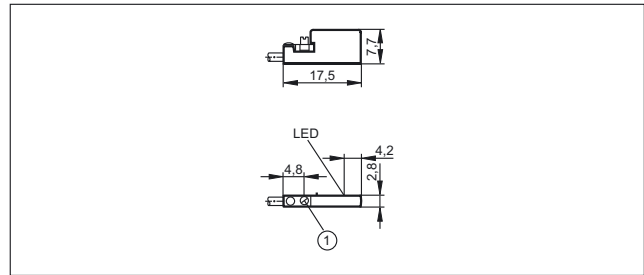

1: Fastening clamp

25

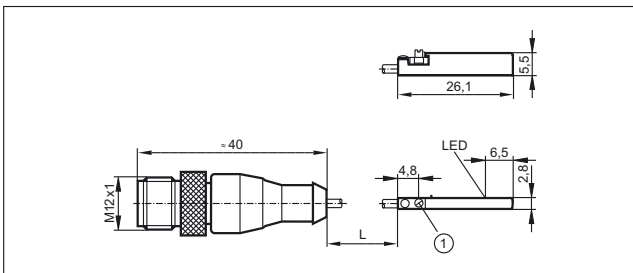

1: Fastening clamp

29

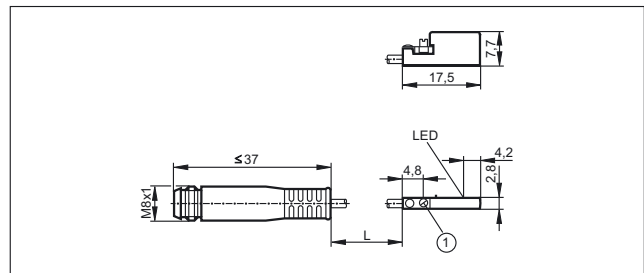

1: Fastening clamp

26

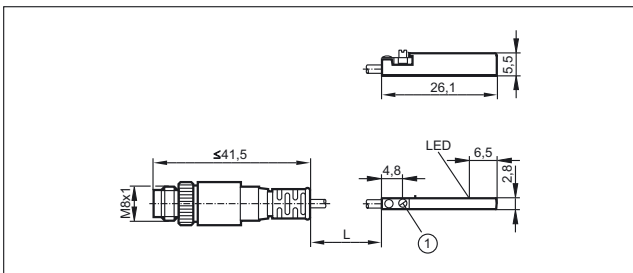

1: Fastening clamp

30

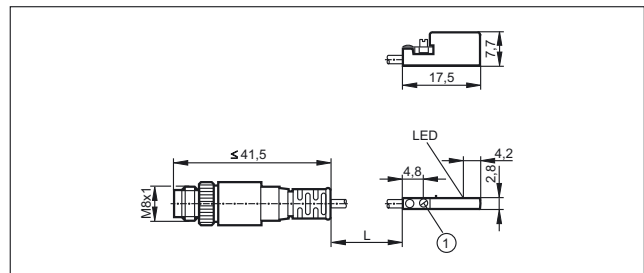

1: Fastening clamp

27

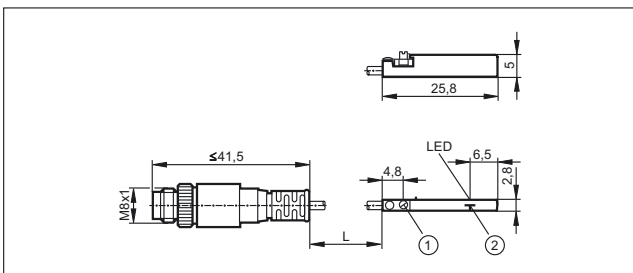

1: Fastening clamp, 2: sensing face



Ultrasonic sensors – hear what's hard to see



Ultrasonic sensors



Robust high-grade stainless steel housing for demanding applications

M18 plastic housing available in the lengths 60 and 98 mm

The vibrating sound transducer reduces the deposit of dirt

Digital and analogue output for point level measurement and distance detection

Setting via teach button, wire teach or IO-Link



Ultrasound



TEACH-IN



IO-Link



High-grade stainless steel



IP 67

The alternative for difficult surfaces

Ultrasonic sensors transmit and receive sound waves in the ultrasonic range. The object to be detected reflects the sound waves and the distance information is determined via time of flight measurement. As opposed to photoelectric sensors colour, transparency or the object's surface shine do not play a role. Blister packages in packaging technology or transparent plastic bowls in the food industry, for example, can be reliably detected.

High performance

The ifm ultrasonic sensors in M18 design provide a particularly small blind zone and long sensing ranges which are usually only achieved by sensors of a considerably larger design. The sensors operate reliably with heavy soiling so that they can be used in applications in which photoelectric sensors meet their limits.

System overview	Page
Ultrasonic diffuse-reflection sensor with plastic housing	212 - 213
Ultrasonic diffuse-reflection sensor with stainless steel housing	213 - 216
Ultrasonic retro-reflective sensor	216
Accessories	217
Wiring diagrams	217
Scale drawings / drawing no. – CAD download: www.ifm.com	218



Position sensors

Ultrasonic diffuse-reflection sensor with plastic housing

Type	Dimensions [mm]	Sensing range [mm]	Material	U _b [V]	Protection	f [Hz]	I _{load} [mA]	Drawing no.	Order no.
------	--------------------	-----------------------	----------	-----------------------	------------	-----------	---------------------------	-------------	-----------

M12 connector · Output function / · 3-wire · DC PNP · Wiring diagram no. 1 · Connector groups 8, 10, 11, 18, 19, 21, 23, 25, 148, 149, 150, 153, 154, 184, 188, 190, 193, 202, 203, 204

	M18 / L = 60.5	300	PBT	10...30	IP 67	8	100	1	UGT200
	M18 / L = 60.5	800	PBT	10...30	IP 67	5	100	1	UGT201
	M18 / L = 60.5	1200	PBT	10...30	IP 67	5	100	1	UGT202

M12 connector · Output function / · 3-wire · DC NPN · Wiring diagram no. 2 · Connector groups 8, 10, 11, 18, 19, 21, 23, 25, 148, 149, 150, 153, 154, 184, 188, 190, 193, 202, 203, 204

	M18 / L = 60.5	300	PBT	10...30	IP 67	8	100	1	UGT209
	M18 / L = 60.5	800	PBT	10...30	IP 67	5	100	1	UGT210
	M18 / L = 60.5	1200	PBT	10...30	IP 67	5	100	1	UGT211

M12 connector · Output function / · 3-wire · DC PNP · Wiring diagram no. 3 · Connector groups 8, 10, 11, 18, 19, 21, 23, 25, 148, 149, 150, 153, 154, 184, 188, 190, 193, 202, 203, 204

	M18 / L = 60.5	300	PBT	10...30	IP 67	8	100	1	UGT212
	M18 / L = 60.5	800	PBT	10...30	IP 67	5	100	1	UGT213
	M18 / L = 60.5	1200	PBT	10...30	IP 67	5	100	1	UGT214



M12 connector · Output function 2 x normally open / closed programmable · 3-wire · DC PNP · Wiring diagram no. 4 · Connector groups 10, 12, 13, 19, 21, 22, 23, 24, 25, 148, 149, 150, 152, 153, 154, 155, 184, 186, 188, 190, 192, 193, 194, 202, 205

	M18 / L = 97.5	1600	PBT	10...30	IP 67	3	100	2	UGT203
	M18 / L = 97.5	2200	PBT	10...30	IP 67	2	100	2	UGT206













M12 connector · Output function 1 x NO / NC programmable + 1 x current output · 3-wire · DC PNP · Wiring diagram no. 5 · Connector groups 10, 12, 13, 19, 21, 22, 23, 24, 25, 148, 149, 150, 152, 153, 154, 155, 184, 186, 188, 190, 192, 193, 194, 202, 205

	M18 / L = 97.5	1600	PBT	10...30	IP 67	3	100	2	UGT204
	M18 / L = 97.5	2200	PBT	10...30	IP 67	2	100	2	UGT207

Product selectors and further information can be found at: www.ifm.com

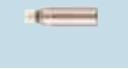













Type	Dimensions [mm]	Sensing range [mm]	Material	U _b [V]	Protection	f [Hz]	I _{load} [mA]	Drawing no.	Order no.
M12 connector · Output function 1 x NO / NC programmable + 1 x voltage output · 3-wire · DC PNP · Wiring diagram no. 5 · Connector groups 10, 12, 13, 19, 21, 22, 23, 24, 25, 148, 149, 150, 152, 153, 154, 155, 184, 186, 188, 190, 192, 193, 194, 202, 205									
	M18 / L = 97.5	1600	PBT	10...30	IP 67	3	100	2	UGT205
	M18 / L = 97.5	2200	PBT	10...30	IP 67	2	100	2	UGT208













Ultrasonic diffuse-reflection sensor with stainless steel housing

Type	Dimensions [mm]	Sensing range [mm]	Material	U _b [V]	Protection	f [Hz]	I _{load} [mA]	Drawing no.	Order no.
M12 connector · Output function  /  · 3-wire · DC PNP · Wiring diagram no. 1 · Connector groups 8, 10, 11, 18, 19, 21, 23, 25, 148, 149, 150, 153, 154, 184, 188, 190, 193, 202, 203, 204									
	M18 / L = 60.5	300	1.4404	10...30	IP 67	8	100	1	UGT500
	M18 / L = 60.5	800	1.4404	10...30	IP 67	5	100	1	UGT503
	M18 / L = 60.5	1200	1.4404	10...30	IP 67	5	100	1	UGT506
M12 connector · Output function  /  · 3-wire · DC NPN · Wiring diagram no. 2 · Connector groups 8, 10, 11, 18, 19, 21, 23, 25, 148, 149, 150, 153, 154, 184, 188, 190, 193, 202, 203, 204									
	M18 / L = 60.5	300	1.4404	10...30	IP 67	8	100	1	UGT521
	M18 / L = 60.5	800	1.4404	10...30	IP 67	5	100	1	UGT522
	M18 / L = 60.5	1200	1.4404	10...30	IP 67	5	100	1	UGT523
M12 connector · Output function 1x analogue 4...20 mA · 3-wire · DC analogue · Wiring diagram no. 6 · Connector groups 8, 10, 19, 21, 23, 25, 148, 149, 153, 184, 188, 193, 202									
	M18 / L = 60.5	300	1.4404	10...30	IP 67	–	–	1	UGT501
	M18 / L = 60.5	800	1.4404	10...30	IP 67	–	–	1	UGT504
	M18 / L = 60.5	1200	1.4404	10...30	IP 67	–	–	1	UGT507



Position sensors







Type	Dimensions [mm]	Sensing range [mm]	Material	U _b [V]	Protection	f [Hz]	I _{load} [mA]	Draw- ing no.	Order no.
M12 connector · Output function 0...10 V analogue · 3-wire · DC analogue · Wiring diagram no. 6 · Connector groups 8, 10, 19, 21, 23, 25, 148, 149, 153, 184, 188, 193, 202									
	M18 / L = 60.5	300	1.4404	10...30	IP 67	–	–	1	UGT502
	M18 / L = 60.5	800	1.4404	10...30	IP 67	–	–	1	UGT505
	M18 / L = 60.5	1200	1.4404	10...30	IP 67	–	–	1	UGT508
M12 connector · Output function  · 3-wire · DC PNP · Wiring diagram no. 3 · Connector groups 8, 10, 11, 18, 19, 21, 23, 25, 148, 149, 150, 153, 154, 184, 188, 190, 193, 202, 203, 204									
	M18 / L = 60.5	300	1.4404	10...30	IP 67	8	100	1	UGT524
	M18 / L = 60.5	800	1.4404	10...30	IP 67	5	100	1	UGT525
	M18 / L = 60.5	1200	1.4404	10...30	IP 67	5	100	1	UGT526
M12 connector · Output function 1 x NO / NC programmable + 1 x current output · 3-wire · DC PNP · Wiring diagram no. 5 · Connector groups 8, 10, 12, 13, 19, 21, 22, 23, 24, 25, 95, 96, 97, 98, 99, 100, 107, 108, 109, 110, 111, 112, 130, 148, 149, 150, 152, 153, 154, 155, 184, 186, 188, 190, 192, 193, 194, 202, 203, 204, 205									
	53 x 20 x 37.7	300	1.4542	10...30	IP 67	8	100	3	UGT580
	53 x 20 x 37.7	800	1.4542	10...30	IP 67	5	100	3	UGT582
	53 x 20 x 37.7	1200	1.4542	10...30	IP 67	5	100	3	UGT584
M12 connector · Output function 1 x NO / NC programmable + 1 x voltage output · 3-wire · DC PNP · Wiring diagram no. 5 · Connector groups 8, 10, 12, 13, 19, 21, 22, 23, 24, 25, 95, 96, 97, 98, 99, 100, 107, 108, 109, 110, 111, 112, 130, 148, 149, 150, 152, 153, 154, 155, 184, 186, 188, 190, 192, 193, 194, 202, 203, 204, 205									
	53 x 20 x 37.7	300	1.4542	10...30	IP 67	8	100	3	UGT581
	53 x 20 x 37.7	800	1.4542	10...30	IP 67	5	100	3	UGT583
	53 x 20 x 37.7	1200	1.4542	10...30	IP 67	5	100	3	UGT585
M12 connector · Output function 1 x NO / NC programmable + 1 x current output · 3-wire · DC NPN · Wiring diagram no. 7 · Connector groups 8, 10, 12, 13, 19, 21, 22, 23, 24, 25, 95, 96, 97, 98, 99, 100, 107, 108, 109, 110, 111, 112, 130, 148, 149, 150, 152, 153, 154, 155, 184, 186, 188, 190, 192, 193, 194, 202, 203, 204, 205									
	53 x 20 x 37.7	300	1.4542	10...30	IP 67	8	100	3	UGT586

Type	Dimensions [mm]	Sensing range [mm]	Material	U _b [V]	Protection	f [Hz]	I _{load} [mA]	Drawing no.	Order no.
M12 connector · Output function 1 x NO / NC programmable + 1 x current output · 3-wire · DC NPN · Wiring diagram no. 7 · Connector groups 8, 10, 12, 13, 19, 21, 22, 23, 24, 25, 95, 96, 97, 98, 99, 100, 107, 108, 109, 110, 111, 112, 130, 148, 149, 150, 152, 153, 154, 155, 184, 186, 188, 190, 192, 193, 194, 202, 203, 204, 205									
	53 x 20 x 37.7	800	1.4542	10...30	IP 67	5	100	3	UGT588
	53 x 20 x 37.7	1200	1.4542	10...30	IP 67	5	100	3	UGT590
M12 connector · Output function 1 x NO / NC programmable + 1 x voltage output · 3-wire · DC NPN · Wiring diagram no. 7 · Connector groups 8, 10, 12, 13, 19, 21, 22, 23, 24, 25, 95, 96, 97, 98, 99, 100, 107, 108, 109, 110, 111, 112, 130, 148, 149, 150, 152, 153, 154, 155, 184, 186, 188, 190, 192, 193, 194, 202, 203, 204, 205									
	53 x 20 x 37.7	300	1.4542	10...30	IP 67	8	100	3	UGT587
	53 x 20 x 37.7	800	1.4542	10...30	IP 67	5	100	3	UGT589
	53 x 20 x 37.7	1200	1.4542	10...30	IP 67	5	100	3	UGT591
M12 connector · Output function 1 x Schließer / Öffner programmierbar · 3-wire · DC PNP · Wiring diagram no. 3 · Connector groups 8, 10, 12, 13, 19, 21, 22, 23, 24, 25, 95, 96, 97, 98, 99, 100, 107, 108, 109, 110, 111, 112, 130, 148, 149, 150, 152, 153, 154, 155, 184, 186, 188, 190, 192, 193, 194, 202, 203, 204, 205									
	53 x 20 x 37.7	300	1.4542	10...30	IP 67	8	100	3	UGT592
	53 x 20 x 37.7	800	1.4542	10...30	IP 67	5	100	3	UGT593
	53 x 20 x 37.7	1200	1.4542	10...30	IP 67	5	100	3	UGT594
M12 connector · Output function 2 x normally open / closed programmable · 3-wire · DC PNP · Wiring diagram no. 4 · Connector groups 10, 12, 13, 19, 21, 22, 23, 24, 25, 148, 149, 150, 152, 153, 154, 155, 184, 186, 188, 190, 192, 193, 194, 202, 205									
	M18 / L = 97.5	1600	1.4404	10...30	IP 67	3	100	2	UGT509
	M18 / L = 97.5	2200	1.4404	10...30	IP 67	2	100	2	UGT512
M12 connector · Output function 1 x NO / NC programmable + 1 x current output · 3-wire · DC PNP · Wiring diagram no. 5 · Connector groups 10, 12, 13, 19, 21, 22, 23, 24, 25, 148, 149, 150, 152, 153, 154, 155, 184, 186, 188, 190, 192, 193, 194, 202, 205									
	M18 / L = 97.5	1600	1.4404	10...30	IP 67	3	100	2	UGT510
	M18 / L = 97.5	2200	1.4404	10...30	IP 67	2	100	2	UGT513
M12 connector · Output function 1 x NO / NC programmable + 1 x voltage output · 3-wire · DC PNP · Wiring diagram no. 5 · Connector groups 10, 12, 13, 19, 21, 22, 23, 24, 25, 148, 149, 150, 152, 153, 154, 155, 184, 186, 188, 190, 192, 193, 194, 202, 205									
	M18 / L = 97.5	1600	1.4404	10...30	IP 67	3	100	2	UGT511







You can find wiring diagrams and scale drawings from page 217



Position sensors









Type	Dimensions [mm]	Sensing range [mm]	Material	U _b [V]	Protection	f [Hz]	I _{load} [mA]	Draw- ing no.	Order no.
M12 connector · Output function 1 x NO / NC programmable + 1 x voltage output · 3-wire · DC PNP · Wiring diagram no. 5 · Connector groups 10, 12, 13, 19, 21, 22, 23, 24, 25, 148, 149, 150, 152, 153, 154, 155, 184, 186, 188, 190, 192, 193, 194, 202, 205									
	M18 / L = 97.5	2200	1.4404	10...30	IP 67	2	100	2	UGT514
M12 connector · Output function 2 x normally open / closed programmable · 3-wire · DC NPN · Wiring diagram no. 8 · Connector groups 10, 12, 13, 19, 21, 22, 23, 24, 25, 148, 149, 150, 152, 153, 154, 155, 184, 186, 188, 190, 192, 193, 194, 202, 205									
	M18 / L = 97.5	1600	1.4404	10...30	IP 67	3	100	2	UGT515
	M18 / L = 97.5	2200	1.4404	10...30	IP 67	2	100	2	UGT518
M12 connector · Output function 1 x NO / NC programmable + 1 x current output · 3-wire · DC NPN · Wiring diagram no. 7 · Connector groups 10, 12, 13, 19, 21, 22, 23, 24, 25, 148, 149, 150, 152, 153, 154, 155, 184, 186, 188, 190, 192, 193, 194, 202, 205									
	M18 / L = 97.5	1600	1.4404	10...30	IP 67	3	100	2	UGT516
	M18 / L = 97.5	2200	1.4404	10...30	IP 67	2	100	2	UGT519
M12 connector · Output function 1 x NO / NC programmable + 1 x voltage output · 3-wire · DC NPN · Wiring diagram no. 7 · Connector groups 10, 12, 13, 19, 21, 22, 23, 24, 25, 148, 149, 150, 152, 153, 154, 155, 184, 186, 188, 190, 192, 193, 194, 202, 205									
	M18 / L = 97.5	1600	1.4404	10...30	IP 67	3	100	2	UGT517
	M18 / L = 97.5	2200	1.4404	10...30	IP 67	2	100	2	UGT520

Ultrasonic retro-reflective sensor

Type	Dimensions [mm]	Sensing range [mm]	Material	U _b [V]	Protection	f [Hz]	I _{load} [mA]	Draw- ing no.	Order no.
M12 connector · Output function  · 3-wire · DC PNP · Wiring diagram no. 9 · Connector groups 10, 12, 13, 19, 21, 22, 23, 24, 25, 148, 149, 150, 152, 153, 154, 155, 184, 186, 188, 190, 192, 193, 194, 202, 205									
	M18 / L = 97.5	1600	1.4404	10...30	IP 67	2	100	2	UGR500
	M18 / L = 97.5	2200	1.4404	10...30	IP 67	2	100	2	UGR501
M12 connector · Output function  · 3-wire · DC NPN · Wiring diagram no. 10 · Connector groups 8, 10, 12, 13, 19, 21, 22, 23, 24, 25, 95, 96, 97, 98, 99, 100, 107, 108, 109, 110, 111, 112, 130, 148, 149, 150, 152, 153, 154, 155, 184, 186, 188, 190, 192, 193, 194, 202, 203, 204, 205									
	M18 / L = 97.5	1600	1.4404	10...30	IP 67	2	100	2	UGR502
	M18 / L = 97.5	2200	1.4404	10...30	IP 67	2	100	2	UGR503

Product selectors and further information can be found at: www.ifm.com

Accessories

Type	Description	Order no.
	Mounting set · Ø 18.5 mm · Clamp mounting · rod mounting Ø 12 mm · for type OG, IG, KG · Housing materials: clamp: diecast zinc / fixture: steel	E20720
	Mounting set · Ø 18.5 mm · Clamp mounting · rod mounting Ø 12 mm · for type OG, IG, KG · Housing materials: clamp: high-grade stainless steel / fixture: high-grade stainless steel	E21206
	Mounting set · Ø 18.5 mm · Clamp mounting · rod mounting Ø 12 mm · for type OG, IG, KG · Housing materials: clamp: diecast zinc / fixture: steel	E20721
	Mounting set · Ø 18.5 mm · Clamp mounting · rod mounting Ø 12 mm · for type OG, IG, KG · Housing materials: clamp: high-grade stainless steel / fixture: high-grade stainless steel	E21207
	mounting rod · Ø 12 / M10 · Length: 130 mm · straight · Housing materials: stainless steel 316Ti / 1.4571	E20938
	mounting rod · Ø 12 / M10 · Length: 200 mm · angled · Housing materials: stainless steel 316Ti / 1.4571	E20940
	Cube · M10 · aluminium profile · Housing materials: diecast zinc	E20951
	Sound Tube · for type UG · Housing materials: POM	E23000

Wiring diagrams

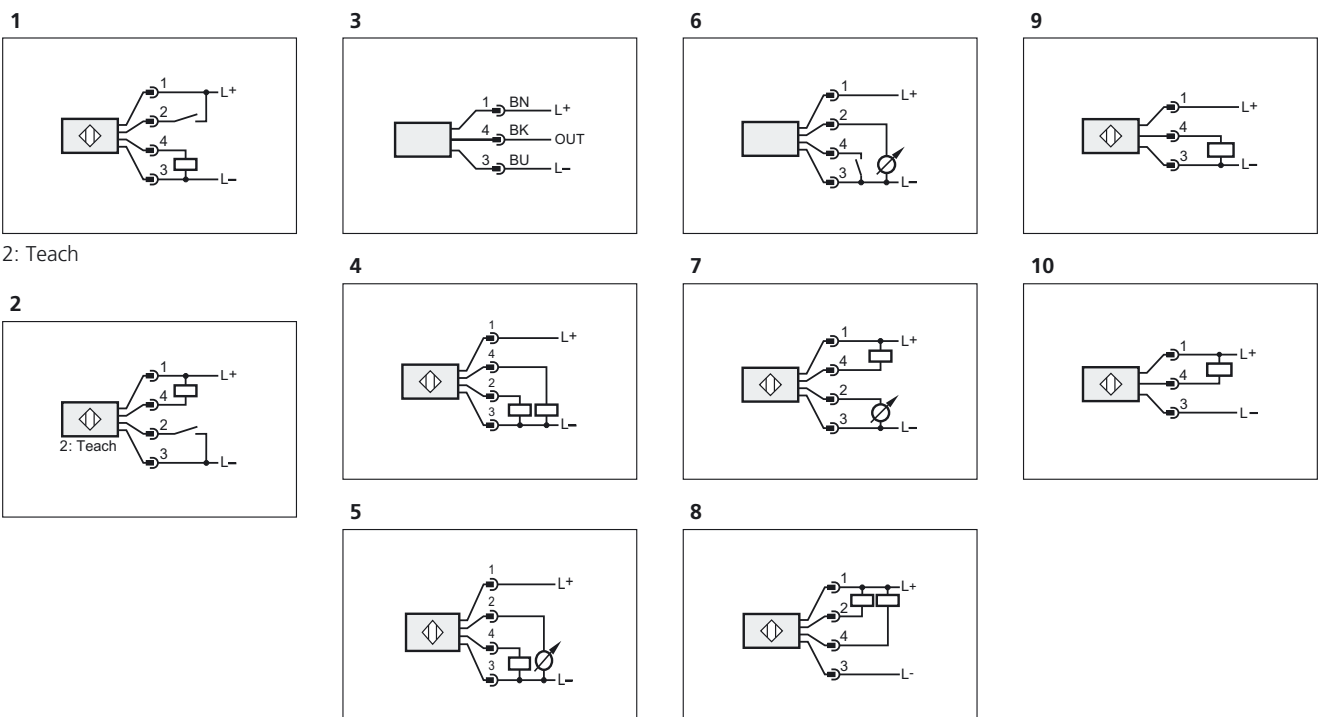



Position sensors

Scale drawings / drawing no. – CAD download: www.ifm.com

1

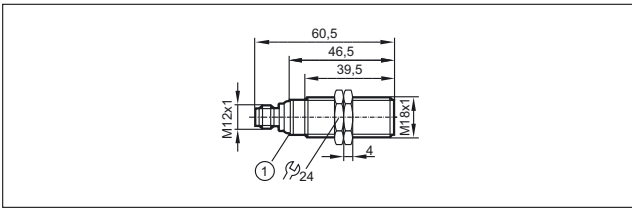

1: LEDs

2

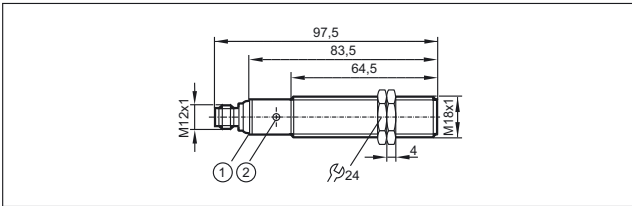

1: LEDs, 2: teach button

3

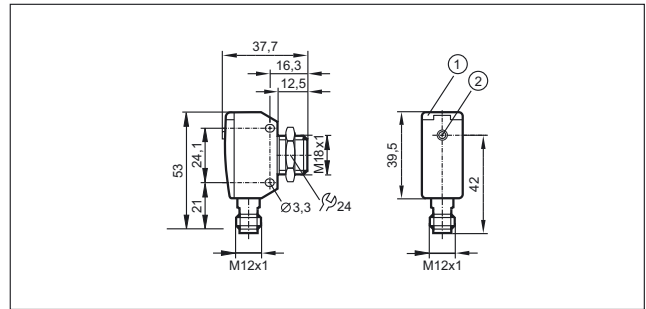

1: LEDs, 2: teach button





Infrared / red light sensors for maximum detection zones



Photoelectric sensors for general applications



Visible red light for easy adjustment

Versions for use in hygienic and wet areas

LED display to check operation, switching status and function

Pushbuttons for quick and easy set-up

Wide range of system components for easy and secure mounting

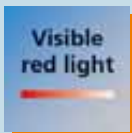

Photoelectric sensors

Photoelectric sensors as „artificial eyes“ are fundamental to automation technology. They are used where a reliable and non-contact detection of the exact position of objects is required. The material of the object to be detected is of no importance. Compared to inductive sensors, photoelectric sensors have a much larger sensing zone.

They are available as through-beam, retro-reflective and diffuse reflection sensors in various designs and sizes.

For hygienic and wet areas, the products of the WetLine series offer special characteristics such as high ingress-resistance up to IP 68 / IP 69K or stainless steel housings.







<i>System overview</i>	<i>Page</i>
Cylindrical OF housing (M12) BasicLine	223 - 224
Cylindrical housing OG (M18) BasicLine	224 - 227
Cylindrical housing OG (M18) PerformanceLine	227 - 228
Cylindrical housing OG (M18) WetLine for hygienic and wet areas	228 - 230
Cylindrical housing OG (M18) BasicLine with lateral sensing face	230 - 231
Rectangular housing OG (M18)	231 - 232
OG series (M18) WetLine with rectangular housing for hygienic and wet areas	232
Rectangular O8 design	233 - 236
Rectangular housing O7 BasicLine	236 - 237
Rectangular housing OJ BasicLine, lateral sensing face	238
Rectangular housing OJ PerformanceLine, lateral sensing face	238 - 239
Rectangular housing OJ PerformanceLine, front sensing face	239
Rectangular plastic housing in O6 design	239 - 243
Rectangular housing O6 PerformanceLine, WetLine for hygienic and wet areas	243 - 248
Rectangular O6 design for oils and coolants	248
Rectangular housing O5 BasicLine	249
Rectangular housing O5 PerformanceLine	249 - 250
Rectangular housing O5 PerformanceLine with ATEX approval 3D	250 - 251
Rectangular OA design with relay output	251
Rectangular housing O4 BasicLine	251 - 252
Rectangular housing O4 PerformanceLine	252 - 253
Prismatic reflectors, reflective tape and fixing components	253 - 254
Software	255
Accessories OA	255
Accessories OF design (M12)	255
Accessories OG design (M18)	255 - 256
Accessories OI design (M30)	256
Accessories O7 housing	257
Accessories OJ housing	257 - 258
Accessories for O6 design	258
Accessories O5 housing	258 - 259
Accessories O4 housing	259 - 260



Position sensors

<i>System overview</i>	<i>Page</i>
Accessories for system components	260 - 261
Wiring diagrams	261 - 263
Scale drawings / drawing no. – CAD download: www.ifm.com	263 - 273

Cylindrical OF housing (M12) BasicLine

Type	Operating principle	Range	Type of light	Spot Ø at max. range [mm]	Output H = light-on D = dark-on	Wiring diagr. no.	Draw- ing no.	Order no.
Through-beam sensor · Cable 2 m · 10...36 DC · metal · IP67								
	Transmitter	4 m	Infrared	700	–	1	1	OF5018
	Receiver	4 m	Infrared	–	H/D PNP	31	1	OF5019
Through-beam sensor · M12 connector · 10...36 DC · metal · IP65 · Connector groups 8, 10, 19, 21, 23, 25, 148, 149, 153, 184, 188, 193, 202								
	Transmitter	4 m	Infrared	700	–	2	2	OF5021
	Receiver	4 m	Infrared	–	H/D PNP	32	3	OF5022
Retro-reflective sensor · Cable 2 m · 10...36 DC · metal · IP67								
	Retro-reflective sensor	0.05...2 m	Infrared	140	H/D PNP	31	1	OF5014
	Polarisation filter	0.2...0.8 m	Red	70	H/D PNP	31	1	OF5024
	Retro-reflective sensor	0.05...2 m	Infrared	140	H/D NPN	33	1	OF5050
Retro-reflective sensor · M12 connector · 10...36 DC · metal · IP65 · Connector groups 8, 10, 19, 21, 23, 25, 148, 149, 153, 184, 188, 193, 202								
	Retro-reflective sensor	0.05...2 m	Infrared	140	H/D PNP	32	3	OF5016
	Polarisation filter	0.2...0.8 m	Red	70	H/D PNP	32	3	OF5025
	Retro-reflective sensor	0.05...2 m	Infrared	140	H/D NPN	34	3	OF5051
	Polarisation filter	0.2...0.8 m	Red	70	H/D NPN	34	3	OF5062
Diffuse reflection sensor · Cable 2 m · 10...36 DC · metal · IP67								
	Diffuse reflection sensor	1...200 mm	Infrared	92	H/D PNP	31	1	OF5010
	Diffuse reflection sensor	1...200 mm	Infrared	92	H/D NPN	35	1	OF5048



Position sensors

Type	Operating principle	Range	Type of light	Spot Ø at max. range [mm]	Output H = light-on D = dark-on	Wiring diagr. no.	Draw- ing no.	Order no.
------	---------------------	-------	---------------	---------------------------	---------------------------------------	-------------------------	---------------------	--------------

Diffuse reflection sensor · Cable 2 m · 10...36 DC · metal · IP67

	Diffuse reflection sensor	1...400 mm	Infrared	185	H/D PNP	31	1	OF5026
---	---------------------------	------------	----------	-----	---------	----	---	--------

Diffuse reflection sensor · Cable 6 m · 10...36 DC · high-grade stainless steel · IP67

	Diffuse reflection sensor	1...200 mm	Infrared	92	H/D PNP	31	1	OF5032
---	---------------------------	------------	----------	----	---------	----	---	--------

Diffuse reflection sensor · M12 connector · 10...36 DC · metal · IP65 · Connector groups 8, 10, 19, 21, 23, 25, 148, 149, 153, 184, 188, 193, 202

	Diffuse reflection sensor	1...200 mm	Infrared	92	H/D PNP	32	3	OF5012
	Diffuse reflection sensor	1...400 mm	Infrared	185	H/D PNP	32	3	OF5027
	Diffuse reflection sensor	1...200 mm	Infrared	92	H/D NPN	36	3	OF5049
	Diffuse reflection sensor	1...400 mm	Infrared	185	H/D NPN	36	3	OF5060

Cylindrical housing OG (M18) BasicLine

Type	Operating principle	Range	Type of light	Spot Ø at max. range [mm]	Output H = light-on D = dark-on	Wiring diagr. no.	Draw- ing no.	Order no.
------	---------------------	-------	---------------	---------------------------	---------------------------------------	-------------------------	---------------------	--------------

Through-beam sensor · M12 connector · 10...30 DC · plastics · IP67 · Connector groups 8, 10, 19, 21, 23, 25, 148, 149, 153, 184, 188, 193, 202







	Transmitter	8 m	Red	600	–	2	4	OGS100
---	-------------	-----	-----	-----	---	---	---	--------

Through-beam sensor · M12 connector · 10...30 DC · plastics · IP67 · Connector groups 8, 10, 11, 18, 19, 21, 23, 25, 148, 149, 150, 153, 154, 184, 188, 190, 193, 202, 203, 204

	Receiver	8 m	Red	–	D PNP	3	4	OGE100
	Receiver	8 m	Red	–	H PNP	4	4	OGE101







Through-beam sensor · M12 connector · 10...30 DC · plastics · IP67 · Connector groups 8, 10, 19, 21, 23, 25, 148, 149, 153, 184, 188, 193, 202



	Receiver	8 m	Red	–	D NPN	5	4	OGE102
	Receiver	8 m	Red	–	H NPN	5	4	OGE103

Type	Operating principle	Range	Type of light	Spot Ø at max. range [mm]	Output H = light-on D = dark-on	Wiring diagr. no.	Draw- ing no.	Order no.
Through-beam sensor · M12 connector · 10...36 DC · high-grade stainless steel · IP67 · Connector groups 8, 10, 19, 21, 23, 25, 148, 149, 153, 184, 188, 193, 202								
	Transmitter	20 m	Red	800	–	2	5	OGS200
Through-beam sensor · M12 connector · 10...36 DC · high-grade stainless steel · IP67 · Connector groups 8, 10, 11, 18, 19, 21, 23, 25, 148, 149, 150, 153, 154, 184, 188, 190, 193, 202, 203, 204								
	Receiver	20 m	Red	–	D PNP	3	5	OGE200
	Receiver	20 m	Red	–	H PNP	4	5	OGE201
Through-beam sensor · Cable 2 m · 20...250 AC/DC (47...63 Hz AC) · plastics · IP67								
	Transmitter	15 m	Infrared	2000	–	6	6	OG0028
	Receiver	15 m	Infrared	–	H AC/DC	7	6	OG0029*
	Receiver	15 m	Infrared	–	D AC/DC	7	6	OG0038*
Through-beam sensor · 1/2" connector · 20...250 AC/DC (47...63 Hz AC) · plastics · IP67 · Connector group 33								
	Transmitter	15 m	Infrared	2000	–	8	7	OG0030
	Receiver	15 m	Infrared	–	H AC/DC	9	7	OG0031*
	Receiver	15 m	Infrared	–	D AC/DC	9	7	OG0039*
Retro-reflective sensor · M12 connector · 10...30 DC · plastics · IP67 · Connector groups 8, 10, 11, 18, 19, 21, 23, 25, 148, 149, 150, 153, 154, 184, 188, 190, 193, 202, 203, 204								
	Polarisation filter	0.05...2.5 m	Red	200	D PNP	3	4	OGP100
	Polarisation filter	0.05...2.5 m	Red	200	H PNP	4	4	OGP101
Retro-reflective sensor · M12 connector · 10...30 DC · plastics · IP67 · Connector groups 8, 10, 19, 21, 23, 25, 148, 149, 153, 184, 188, 193, 202								
	Polarisation filter	0.05...2.5 m	Red	200	D NPN	5	4	OGP102
	Polarisation filter	0.05...2.5 m	Red	200	H NPN	5	4	OGP103



Position sensors





Type	Operating principle	Range	Type of light	Spot Ø at max. range [mm]	Output H = light-on D = dark-on	Wiring diagr. no.	Draw- ing no.	Order no.
Retro-reflective sensor · M12 connector · 10...36 DC · high-grade stainless steel · IP67 · Connector groups 8, 10, 11, 18, 19, 21, 23, 25, 148, 149, 150, 153, 154, 184, 188, 190, 193, 202, 203, 204								
	Polarisation filter	0.03...4 m	Red	160	D PNP	3	5	OGP200
	Polarisation filter	0.03...4 m	Red	160	H PNP	4	5	OGP201
Retro-reflective sensor · Cable 2 m · 20...250 AC/DC (47...63 Hz AC) · plastics · IP67								
	Polarisation filter	3 m	Red	262	H AC/DC	7	6	OG0043*
	Polarisation filter	3 m	Red	262	D AC/DC	7	6	OG0032*
Retro-reflective sensor · 1/2" connector · 20...250 AC/DC (47...63 Hz AC) · plastics · IP67 · Connector group 33								
	Polarisation filter	3 m	Red	262	H AC/DC	9	7	OG0044*
	Polarisation filter	3 m	Red	262	D AC/DC	9	7	OG0033*
Diffuse reflection sensor · M12 connector · 10...30 DC · plastics · IP65 · Connector groups 8, 10, 11, 18, 19, 21, 23, 25, 148, 149, 150, 153, 154, 184, 188, 190, 193, 202, 203, 204								
	Diffuse reflection sensor	10...400 mm	Red	25	H PNP	3	8	OGT100
	Diffuse reflection sensor	10...400 mm	Red	25	D PNP	3	8	OGT101
Diffuse reflection sensor · M12 connector · 10...30 DC · plastics · IP65 · Connector groups 8, 10, 19, 21, 23, 25, 148, 149, 153, 184, 188, 193, 202								
	Diffuse reflection sensor	10...400 mm	Red	25	H NPN	5	8	OGT102
	Diffuse reflection sensor	10...400 mm	Red	25	D NPN	5	8	OGT103
Diffuse reflection sensor · M12 connector · 10...36 DC · high-grade stainless steel · IP65 · Connector groups 8, 10, 11, 18, 19, 21, 23, 25, 148, 149, 150, 153, 154, 184, 188, 190, 193, 202, 203, 204								
	Diffuse reflection sensor	2...600 mm	Red	50	H PNP	3	9	OGT200
	Background suppression	15...250 mm	Red	21	H PNP	3	9	OGH200

Type	Operating principle	Range	Type of light	Spot Ø at max. range [mm]	Output H = light-on D = dark-on	Wiring diagr. no.	Draw- ing no.	Order no.
Diffuse reflection sensor · Cable 2 m · 20...250 AC/DC (47...63 Hz AC) · plastics · IP67								
	Diffuse reflection sensor	1...600 mm	Infrared	< 169	H AC/DC	7	6	OG0034*
	Diffuse reflection sensor	1...600 mm	Infrared	< 169	D AC/DC	7	6	OG0040*
Diffuse reflection sensor · 1/2" connector · 20...250 AC/DC (47...63 Hz AC) · plastics · IP67 · Connector group 33								
	Diffuse reflection sensor	1...600 mm	Infrared	< 169	H AC/DC	9	7	OG0035*
	Diffuse reflection sensor	1...600 mm	Infrared	< 169	D AC/DC	9	7	OG0041*

*** Note on use of miniature fuses for electrical connection**



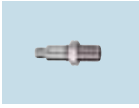

Miniature fuse to IEC60127-2 sheet 1, ≤ 2 A (fast acting) Recommendation: check the unit for reliable function after a short circuit.

Cylindrical housing OG (M18) PerformanceLine

Type	Operating principle	Range	Type of light	Spot Ø at max. range [mm]	Output H = light-on D = dark-on	Wiring diagr. no.	Draw- ing no.	Order no.
Through-beam sensor · Cable 2 m · 10...36 DC · high-grade stainless steel · IP67								
	Transmitter	25 m	Red	1000	–	1	10	OGS501
	Receiver	25 m	Red	–	H/D PNP	10	11	OGE502
Through-beam sensor · M12 connector · 10...36 DC · high-grade stainless steel · IP67 · Connector groups 8, 10, 19, 21, 23, 25, 148, 149, 153, 184, 188, 193, 202								
	Transmitter	25 m	Red	1000	–	2	12	OGS500
Through-beam sensor · M12 connector · 10...36 DC · high-grade stainless steel · IP67 · Connector groups 8, 10, 11, 18, 19, 21, 23, 25, 148, 149, 150, 153, 154, 184, 188, 190, 193, 202, 203, 204								
	Receiver	25 m	Red	–	H/D PNP	3	13	OGE500
Retro-reflective sensor · Cable 2 m · 10...36 DC · high-grade stainless steel · IP67								
	Polarisation filter	0.03...5 m	Red	200	H/D PNP	10	11	OGP502







Position sensors

Type	Operating principle	Range	Type of light	Spot Ø at max. range [mm]	Output H = light-on D = dark-on	Wiring diagr. no.	Draw- ing no.	Order no.
Retro-reflective sensor · M12 connector · 10...36 DC · high-grade stainless steel · IP67 · Connector groups 8, 10, 11, 18, 19, 21, 23, 25, 148, 149, 150, 153, 154, 184, 188, 190, 193, 202, 203, 204								
	Polarisation filter	0.03...5 m	Red	200	H/D PNP	3	13	OGP500
Retro-reflective sensor · M12 connector · 10...36 DC · high-grade stainless steel · IP67 · Connector groups 8, 10, 19, 21, 23, 25, 148, 149, 153, 184, 188, 193, 202								
	Polarisation filter	0.03...5 m	Red	200	H/D NPN	5	13	OGP503
Diffuse reflection sensor · Cable 2 m · 10...36 DC · high-grade stainless steel · IP67								
	Background suppression	15...300 mm	Red	25	H/D PNP	10	11	OGH501
Diffuse reflection sensor · M12 connector · 10...36 DC · high-grade stainless steel · IP67 · Connector groups 8, 10, 11, 18, 19, 21, 23, 25, 148, 149, 150, 153, 154, 184, 188, 190, 193, 202, 203, 204								
	Diffuse reflection sensor	2...800 mm	Red	66	H/D PNP	3	13	OGT500
	Background suppression	15...300 mm	Red	25	H/D PNP	3	13	OGH500
Diffuse reflection sensor · M12 connector · 10...36 DC · high-grade stainless steel · IP67 · Connector groups 8, 10, 19, 21, 23, 25, 148, 149, 153, 184, 188, 193, 202								
	Background suppression	15...300 mm	Red	25	H/D NPN	5	13	OGH504
	Background suppression	15...300 mm	Red	25	H/D NPN	5	13	OGH502

Cylindrical housing OG (M18) WetLine for hygienic and wet areas

Type	Operating principle	Range	Type of light	Spot Ø at max. range [mm]	Output H = light-on D = dark-on	Wiring diagr. no.	Draw- ing no.	Order no.
Through-beam sensor · Cable 6 m · 10...36 DC · high-grade stainless steel · IP67 / IP68 / IP69K								
	Transmitter	20 m	Red	800	–	1	14	OGS301
	Receiver	20 m	Red	–	D PNP	10	14	OGE302
	Receiver	20 m	Red	–	H PNP	10	14	OGE303

Type	Operating principle	Range	Type of light	Spot Ø at max. range [mm]	Output H = light-on D = dark-on	Wiring diagr. no.	Draw- ing no.	Order no.
Through-beam sensor · M12 connector · 10...36 DC · high-grade stainless steel · IP67 / IP68 / IP69K · Connector groups 148, 153, 184, 188, 193								
	Transmitter	20 m	Red	800	–	2	5	OGS300
Through-beam sensor · M12 connector · 10...36 DC · high-grade stainless steel · IP67 / IP68 / IP69K · Connector groups 148, 150, 153, 154, 184, 188, 190, 193								
	Receiver	20 m	Red	–	D PNP	3	5	OGE300
	Receiver	20 m	Red	–	H PNP	4	5	OGE301
Retro-reflective sensor · Cable 6 m · 10...36 DC · high-grade stainless steel · IP67 / IP68 / IP69K								
	Polarisation filter	0.03...4 m	Red	160	D PNP	10	14	OGP302
	Polarisation filter	0.03...4 m	Red	160	H PNP	10	14	OGP303
Retro-reflective sensor · M12 connector · 10...36 DC · high-grade stainless steel · IP67 / IP68 / IP69K · Connector groups 148, 150, 153, 154, 184, 188, 190, 193								
	Polarisation filter	0.03...4 m	Red	160	D PNP	3	5	OGP300
	Polarisation filter	0.03...4 m	Red	160	H PNP	4	5	OGP301
Diffuse reflection sensor · Cable 6 m · 10...36 DC · high-grade stainless steel · IP67 / IP68 / IP69K								
	Background suppression	100 mm	Red	9	H PNP	10	15	OGH306
	Background suppression	100 mm	Red	9	D PNP	10	15	OGH307
	Background suppression	200 mm	Red	17	H PNP	10	15	OGH308
	Background suppression	200 mm	Red	17	D PNP	10	15	OGH309
	Background suppression	300 mm	Red	25	H PNP	10	15	OGH310
	Background suppression	300 mm	Red	25	D PNP	10	15	OGH311



Position sensors

Type	Operating principle	Range	Type of light	Spot Ø at max. range [mm]	Output H = light-on D = dark-on	Wiring diagr. no.	Draw- ing no.	Order no.
------	---------------------	-------	---------------	---------------------------	---------------------------------------	-------------------------	---------------------	--------------

Diffuse reflection sensor · M12 connector · 10...36 DC · high-grade stainless steel · IP67 / IP68 / IP69K · Connector groups 148, 150, 153, 154, 184, 188, 190, 193

	Background suppression	100 mm	Red	9	H PNP	3	16	OGH300
	Background suppression	100 mm	Red	9	D PNP	3	16	OGH301
	Background suppression	200 mm	Red	17	H PNP	3	16	OGH302
	Background suppression	200 mm	Red	17	D PNP	3	16	OGH303
	Background suppression	300 mm	Red	25	H PNP	3	16	OGH304
	Background suppression	300 mm	Red	25	D PNP	3	16	OGH305

Cylindrical housing OG (M18) BasicLine with lateral sensing face

Type	Operating principle	Range	Type of light	Spot Ø at max. range [mm]	Output H = light-on D = dark-on	Wiring diagr. no.	Draw- ing no.	Order no.
------	---------------------	-------	---------------	---------------------------	---------------------------------------	-------------------------	---------------------	--------------

Through-beam sensor · M12 connector · 10...30 DC · high-grade stainless steel · IP68 · Connector groups 8, 10, 19, 21, 23, 25, 148, 149, 153, 184, 188, 193, 202

	Transmitter	9 m	Red	< 3000	–	2	17	OG5129
	Receiver	9 m	Red	–	H PNP	11	17	OG5127
	Receiver	9 m	Red	–	D PNP	12	17	OG5128

Retro-reflective sensor · M12 connector · 10...30 DC · high-grade stainless steel · IP68 · Connector groups 8, 10, 19, 21, 23, 25, 148, 149, 153, 184, 188, 193, 202

	Polarisation filter	3 m	Red	< 96	H PNP	11	17	OG5125
	Polarisation filter	3 m	Red	< 96	D PNP	12	17	OG5126

Diffuse reflection sensor · M12 connector · 10...30 DC · high-grade stainless steel · IP68 · Connector groups 8, 10, 19, 21, 23, 25, 148, 149, 153, 184, 188, 193, 202

	Background suppression	100 mm	Red	< 16	H PNP	11	18	OG5123
---	------------------------	--------	-----	------	-------	----	----	---------------

Type	Operating principle	Range	Type of light	Spot Ø at max. range [mm]	Output H = light-on D = dark-on	Wiring diagr. no.	Draw- ing no.	Order no.
------	---------------------	-------	---------------	---------------------------	---------------------------------------	-------------------------	---------------------	--------------

Diffuse reflection sensor · M12 connector · 10...30 DC · high-grade stainless steel · IP68 · Connector groups 8, 10, 11, 18, 19, 21, 23, 25, 148, 149, 150, 153, 154, 184, 188, 190, 193, 202, 203, 204

	Background suppression	200 mm	Red	< 28	H PNP	11	18	OG5124
---	------------------------	--------	-----	------	-------	----	----	--------

Rectangular housing OG (M18)

Type	Operating principle	Range	Type of light	Spot Ø at max. range [mm]	Output H = light-on D = dark-on	Wiring diagr. no.	Draw- ing no.	Order no.
------	---------------------	-------	---------------	---------------------------	---------------------------------------	-------------------------	---------------------	--------------

Through-beam sensor · M12 connector · 10...30 DC · metal · IP67 · Connector groups 8, 10, 19, 21, 23, 25, 148, 149, 153, 184, 188, 193, 202

	Transmitter	20 m	Red	800	–	2	19	OGS280
---	-------------	------	-----	-----	---	---	----	--------

	Receiver	20 m	Red	–	D NPN	13	19	OGE282
--	----------	------	-----	---	-------	----	----	--------

Through-beam sensor · M12 connector · 10...30 DC · metal · IP67 · Connector groups 8, 10, 11, 18, 19, 21, 23, 25, 148, 149, 150, 153, 154, 184, 188, 190, 193, 202, 203, 204

	Receiver	20 m	Red	–	D PNP	14	19	OGE280
---	----------	------	-----	---	-------	----	----	--------

	Receiver	20 m	Red	–	H PNP	4	19	OGE281
---	----------	------	-----	---	-------	---	----	--------

Retro-reflective sensor · M12 connector · 10...30 DC · metal · IP67 · Connector groups 8, 10, 11, 18, 19, 21, 23, 25, 148, 149, 150, 153, 154, 184, 188, 190, 193, 202, 203, 204

	Polarisation filter	0.1...4 m	Red	160	D PNP	14	19	OGP280
---	---------------------	-----------	-----	-----	-------	----	----	--------

	Polarisation filter	0.1...4 m	Red	160	H PNP	4	19	OGP281
---	---------------------	-----------	-----	-----	-------	---	----	--------

Retro-reflective sensor · M12 connector · 10...30 DC · metal · IP67 · Connector groups 8, 10, 19, 21, 23, 25, 148, 149, 153, 184, 188, 193, 202

	Polarisation filter	0.1...4 m	Red	160	D NPN	13	19	OGP282
---	---------------------	-----------	-----	-----	-------	----	----	--------

	Polarisation filter	0.1...4 m	Red	160	H NPN	15	19	OGP283
---	---------------------	-----------	-----	-----	-------	----	----	--------

Diffuse reflection sensor · M12 connector · 10...30 DC · metal · IP67 · Connector groups 8, 10, 11, 18, 19, 21, 23, 25, 148, 149, 150, 153, 154, 184, 188, 190, 193, 202, 203, 204

	Background suppression	100 mm	Red	7	H PNP	4	19	OGH280
---	------------------------	--------	-----	---	-------	---	----	--------

	Background suppression	200 mm	Red	13	H PNP	4	19	OGH281
---	------------------------	--------	-----	----	-------	---	----	--------



Position sensors

Type	Operating principle	Range	Type of light	Spot Ø at max. range [mm]	Output H = light-on D = dark-on	Wiring diagr. no.	Draw- ing no.	Order no.
------	---------------------	-------	---------------	---------------------------	---------------------------------------	-------------------------	---------------------	--------------

Diffuse reflection sensor · M12 connector · 10...30 DC · metal · IP67 · Connector groups 8, 10, 11, 18, 19, 21, 23, 25, 148, 149, 150, 153, 154, 184, 188, 190, 193, 202, 203, 204



Background suppression	15...200 mm	Red	13	H/D PNP	3	20	OGH580
------------------------	-------------	-----	----	---------	---	----	---------------

Diffuse reflection sensor · M12 connector · 10...30 DC · metal · IP67 · Connector groups 8, 10, 19, 21, 23, 25, 148, 149, 153, 184, 188, 193, 202



Background suppression	100 mm	Red	7	H NPN	15	19	OGH282
------------------------	--------	-----	---	-------	----	----	---------------



Background suppression	200 mm	Red	13	H NPN	15	19	OGH283
------------------------	--------	-----	----	-------	----	----	---------------



Background suppression	15...200 mm	Red	13	H/D NPN	5	20	OGH581
------------------------	-------------	-----	----	---------	---	----	---------------

OG series (M18) WetLine with rectangular housing for hygienic and wet areas

Type	Operating principle	Range	Type of light	Spot Ø at max. range [mm]	Output H = light-on D = dark-on	Wiring diagr. no.	Draw- ing no.	Order no.
------	---------------------	-------	---------------	---------------------------	---------------------------------------	-------------------------	---------------------	--------------

Through-beam sensor · M12 connector · 10...30 DC · metal · IP67 / IP68 / IP69K · Connector groups 8, 10, 19, 21, 23, 25, 148, 149, 153, 184, 188, 193, 202



Transmitter	15 m	Red	800	–	2	21	OGS380
-------------	------	-----	-----	---	---	----	---------------

Through-beam sensor · M12 connector · 10...30 DC · metal · IP67 / IP68 / IP69K · Connector groups 8, 10, 11, 18, 19, 21, 23, 25, 148, 149, 150, 153, 154, 184, 188, 190, 193, 202, 203, 204



Receiver	15 m	Red	–	D PNP	14	21	OGE380
----------	------	-----	---	-------	----	----	---------------

Receiver	15 m	Red	–	H PNP	4	21	OGE381
----------	------	-----	---	-------	---	----	---------------

Receiver	15 m	Red	–	D NPN	13	21	OGE382
----------	------	-----	---	-------	----	----	---------------

Diffuse reflection sensor · M12 connector · 10...30 DC · metal · IP67 / IP68 / IP69K · Connector groups 8, 10, 11, 18, 19, 21, 23, 25, 148, 149, 150, 153, 154, 184, 188, 190, 193, 202, 203, 204



Background suppression	100 mm	Red	7	H PNP	4	21	OGH380
------------------------	--------	-----	---	-------	---	----	---------------













Background suppression	200 mm	Red	13	H PNP	4	21	OGH381
------------------------	--------	-----	----	-------	---	----	---------------

Background suppression	100 mm	Red	7	H NPN	15	21	OGH382
------------------------	--------	-----	---	-------	----	----	---------------

Background suppression	200 mm	Red	13	H NPN	15	21	OGH383
------------------------	--------	-----	----	-------	----	----	---------------













Product selectors and further information can be found at: www.ifm.com



Rectangular O8 design

Type	Operating principle	Range	Type of light	Spot Ø at max. range [mm]	Output H = light-on D = dark-on	Wiring diagr. no.	Draw- ing no.	Order no.
Diffuse reflection sensor · Cable 2 m · 10...30 DC · metal · IP65 / IP67								
	Background suppression	3...15 mm	Red	4	H PNP	16	22	O8H200
	Background suppression	1...30 mm	Red	4	H PNP	16	22	O8H206
	Background suppression	1...50 mm	Red	4	H PNP	16	22	O8H212
	Background suppression	1...80 mm	Red	4.5	H PNP	16	22	O8H218
Diffuse reflection sensor · Cable 0.3 m · with M8 connector · 10...30 DC · metal · IP65 / IP67 · Connector groups 122, 123								
	Background suppression	3...15 mm	Red	4	H PNP	4	22	O8H202
	Background suppression	1...30 mm	Red	4	H PNP	4	22	O8H208
	Background suppression	1...50 mm	Red	4	H PNP	4	23	O8H214
	Background suppression	1...80 mm	Red	4.5	H PNP	4	22	O8H220
Diffuse reflection sensor · Cable 0.3 m · with M8 connector · 10...30 DC · metal · IP65 / IP67 · Connector groups 4, 5, 80, 86, 147								
	Background suppression	3...15 mm	Red	4	H PNP	4	22	O8H204
	Background suppression	1...30 mm	Red	4	H PNP	4	22	O8H210
	Background suppression	1...50 mm	Red	4	H PNP	4	22	O8H216
	Background suppression	1...80 mm	Red	4.5	H PNP	4	22	O8H222
Diffuse reflection sensor · Cable 2 m · 10...30 DC · metal · IP65 / IP67								
	Background suppression	3...15 mm	Red	4	H NPN	17	22	O8H201



Position sensors

Type	Operating principle	Range	Type of light	Spot Ø at max. range [mm]	Output H = light-on D = dark-on	Wiring diag. no.	Draw- ing no.	Order no.
Diffuse reflection sensor · Cable 2 m · 10...30 DC · metal · IP65 / IP67								
	Background suppression	1...30 mm	Red	4	H NPN	17	22	O8H207
	Background suppression	1...50 mm	Red	4	H NPN	17	22	O8H213
	Background suppression	1...80 mm	Red	4.5	H NPN	17	22	O8H219
Diffuse reflection sensor · Cable 0.3 m · with M8 connector · 10...30 DC · metal · IP65 / IP67 · Connector groups 122, 123								
	Background suppression	3...15 mm	Red	4	H NPN	15	22	O8H203
	Background suppression	1...30 mm	Red	4	H NPN	15	22	O8H209
	Background suppression	1...50 mm	Red	4	H NPN	15	22	O8H215
	Background suppression	1...80 mm	Red	4.5	H NPN	15	22	O8H221
Diffuse reflection sensor · Cable 0.3 m · with M8 connector · 10...30 DC · metal · IP65 / IP67 · Connector groups 4, 5, 80, 86, 147								
	Background suppression	3...15 mm	Red	4	H NPN	15	22	O8H205
	Background suppression	1...30 mm	Red	4	H NPN	15	22	O8H211
	Background suppression	1...50 mm	Red	4	H NPN	15	22	O8H217
	Background suppression	1...80 mm	Red	4.5	H NPN	15	22	O8H223
Diffuse reflection sensor · Cable 0.3 m · with M8 connector · 10...30 DC · metal · IP65 / IP67 · Connector groups 122, 123								
	Diffuse reflection sensor	0...180 mm	Red	18	H PNP	4	24	O8T202
	Diffuse reflection sensor	0...180 mm	Red	18	H NPN	15	25	O8T203

Type	Operating principle	Range	Type of light	Spot Ø at max. range [mm]	Output H = light-on D = dark-on	Wiring diagr. no.	Draw- ing no.	Order no.
Diffuse reflection sensor · Cable 0.3 m · with M8 connector · 10...30 DC · metal · IP65 / IP67 · Connector groups 4, 5, 80, 86, 147								
	Diffuse reflection sensor	0...180 mm	Red	18	H PNP	4	25	O8T204
	Diffuse reflection sensor	0...180 mm	Red	18	H NPN	15	25	O8T205
Diffuse reflection sensor · Cable 2 m · 10...30 DC · metal · IP65 / IP67								
	Diffuse reflection sensor	0...180 mm	Red	18	H PNP	16	25	O8T200
	Diffuse reflection sensor	0...180 mm	Red	18	H NPN	17	25	O8T201
Retro-reflective sensor · Cable 0.3 m · with M8 connector · 10...30 DC · metal · IP65 / IP67 · Connector groups 122, 123								
	Polarisation filter	20...1800 mm	Red	120	D PNP	14	25	O8P202
	Polarisation filter	20...1800 mm	Red	120	D NPN	13	25	O8P203
Retro-reflective sensor · Cable 0.3 m · with M8 connector · 10...30 DC · metal · IP65 / IP67 · Connector groups 4, 5, 80, 86, 147								
	Polarisation filter	20...1800 mm	Red	120	D PNP	14	25	O8P204
	Polarisation filter	20...1800 mm	Red	120	D NPN	13	25	O8P205
Retro-reflective sensor · Cable 2 m · 10...30 DC · metal · IP65 / IP67								
	Polarisation filter	20...1800 mm	Red	120	D PNP	18	25	O8P200
	Polarisation filter	20...1800 mm	Red	120	D NPN	19	25	O8P201
Through-beam sensor · Cable 0.3 m · with M8 connector · 10...30 DC · metal · IP65 / IP67 · Connector groups 122, 123								
	Receiver	3 m	Red	–	D PNP	14	26	O8E202
	Receiver	3 m	Red	–	D NPN	13	27	O8E203
	Transmitter	3 m	Red	200	–	2	28	O8S201

You can find wiring diagrams and scale drawings from page 261





Position sensors

Type	Operating principle	Range	Type of light	Spot Ø at max. range [mm]	Output H = light-on D = dark-on	Wiring diagr. no.	Draw- ing no.	Order no.
------	---------------------	-------	---------------	---------------------------	---------------------------------------	-------------------------	---------------------	--------------

Through-beam sensor · Cable 0.3 m · with M8 connector · 10...30 DC · metal · IP65 / IP67 · Connector groups 4, 5, 80, 86, 147

	Receiver	3 m	Red	–	D PNP	14	27	O8E204
	Receiver	3 m	Red	–	D NPN	13	27	O8E205
	Transmitter	3 m	Red	200	–	2	29	O8S202

Through-beam sensor · Cable 2 m · 10...30 DC · metal · IP65 / IP67

	Receiver	3 m	Red	–	D PNP	20	27	O8E200
	Receiver	3 m	Red	–	D NPN	21	27	O8E201
	Transmitter	3 m	Red	200	–	1	29	O8S200

Rectangular housing O7 BasicLine

Type	Operating principle	Range	Type of light	Spot Ø at max. range [mm]	Output H = light-on D = dark-on	Wiring diagr. no.	Draw- ing no.	Order no.
------	---------------------	-------	---------------	---------------------------	---------------------------------------	-------------------------	---------------------	--------------

Through-beam sensor · Cable 0.2 m · with M8 connector · 10...30 DC · plastics · IP65 · Connector groups 1, 3, 78, 84, 145

	Transmitter	0...1.5 m	Red	90	–	2	30	O7S200
---	-------------	-----------	-----	----	---	---	----	---------------

Through-beam sensor · Cable 0.2 m · with M8 connector · 10...30 DC · plastics · IP65 · Connector groups 1, 2, 3, 78, 84, 145, 146

	Receiver	0...1.5 m	Red	–	D PNP	14	31	O7E200
	Receiver	0...1.5 m	Red	–	H PNP	4	31	O7E201
	Receiver	0...1.5 m	Red	–	D NPN	13	31	O7E202
	Receiver	0...1.5 m	Red	–	H NPN	15	31	O7E203

Type	Operating principle	Range	Type of light	Spot Ø at max. range [mm]	Output H = light-on D = dark-on	Wiring diagr. no.	Draw- ing no.	Order no.
------	---------------------	-------	---------------	---------------------------	---------------------------------------	-------------------------	---------------------	--------------

Retro-reflective sensor · Cable 0.2 m · with M8 connector · 10...30 DC · plastics · IP65 · Connector groups 1, 2, 3, 78, 84, 145, 146

	Polarisation filter	0.03...1 m	Red	55	D PNP	14	32	O7P200
	Polarisation filter	0.03...1 m	Red	55	H PNP	4	32	O7P201
	Polarisation filter	0.03...1 m	Red	55	D NPN	13	32	O7P202
	Polarisation filter	0.03...1 m	Red	55	H NPN	15	32	O7P203





Diffuse reflection sensor · Cable 0.2 m · with M8 connector · 10...30 DC · plastics · IP65 · Connector groups 1, 2, 3, 78, 84, 145, 146

	Background suppression	5...30 mm	Red	2.5	H PNP	4	33	O7H200
	Background suppression	5...30 mm	Red	2.5	D PNP	14	33	O7H201
	Background suppression	5...30 mm	Red	2.5	H NPN	15	33	O7H206
	Background suppression	5...30 mm	Red	2.5	D NPN	13	33	O7H207
	Background suppression	5...50 mm	Red	2.5	H PNP	4	33	O7H202
	Background suppression	5...50 mm	Red	2.5	H NPN	15	33	O7H208
	Background suppression	5...50 mm	Red	2.5	D NPN	13	33	O7H209
	Background suppression	5...50 mm	Red	2.5	D PNP	14	33	O7H203
	Background suppression	3...100 mm	Red	7	H PNP	4	33	O7H204
	Background suppression	3...100 mm	Red	7	D PNP	14	33	O7H205
	Background suppression	3...100 mm	Red	7	H NPN	15	33	O7H210
	Background suppression	3...100 mm	Red	7	D NPN	13	33	O7H211







Position sensors

Rectangular housing OJ BasicLine, lateral sensing face

Type	Operating principle	Range	Type of light	Spot Ø at max. range [mm]	Output H = light-on D = dark-on	Wiring diagr. no.	Draw- ing no.	Order no.
Through-beam sensor · M8 connector · 10...30 DC · plastics · IP67 · Connector groups 1, 3, 78, 84, 145								
	Transmitter	0...10 m	Red	< 1000	–	2	34	OJS200
Through-beam sensor · M8 connector · 10...30 DC · plastics · IP67 · Connector groups 1, 2, 3, 78, 84, 145, 146								
	Receiver	10 m	–	–	D PNP	3	34	OJE200
Retro-reflective sensor · M8 connector · 10...30 DC · plastics · IP67 · Connector groups 1, 2, 3, 78, 84, 145, 146								
	Retro-reflective sensor	1.8 m	Red	64	D PNP	3	34	OJR200
	Polarisation filter	1.8 m	Red	64	D PNP	3	34	OJP200
Diffuse reflection sensor · M8 connector · 10...30 DC · plastics · IP67 · Connector groups 1, 2, 3, 78, 84, 145, 146								
	Background suppression	100 mm	Red	< 13	H PNP	3	35	OJH200

Rectangular housing OJ PerformanceLine, lateral sensing face

Type	Operating principle	Range	Type of light	Spot Ø at max. range [mm]	Output H = light-on D = dark-on	Wiring diagr. no.	Draw- ing no.	Order no.
Through-beam sensor · M8 connector · 10...30 DC · plastics · IP67 · Connector groups 4, 5, 80, 86, 147								
	Transmitter	10 m	Red	1000	–	2	36	OJ5130
	Receiver	10 m	Red	–	H/D PNP	22	36	OJ5131
Retro-reflective sensor · M8 connector · 10...30 DC · plastics · IP67 · Connector groups 4, 5, 80, 86, 147								
	Polarisation filter	0...2 m	Red	64	H/D PNP	22	36	OJ5126
Diffuse reflection sensor · M8 connector · 10...30 DC · plastics · IP67 · Connector groups 4, 5, 80, 86, 147								
	Diffuse reflection sensor	1...600 mm	Red	60	H/D PNP	22	37	OJ5122

Type	Operating principle	Range	Type of light	Spot Ø at max. range [mm]	Output H = light-on D = dark-on	Wiring diagr. no.	Draw- ing no.	Order no.
------	---------------------	-------	---------------	---------------------------	---------------------------------------	-------------------------	---------------------	--------------

Diffuse reflection sensor · M8 connector · 10...30 DC · plastics · IP67 · Connector groups 4, 5, 80, 86, 147

	Background suppression	15...400 mm	Red	< 18	H/D PNP	22	38	OJ5148
---	------------------------	-------------	-----	------	---------	----	----	---------------

Rectangular housing OJ PerformanceLine, front sensing face

Type	Operating principle	Range	Type of light	Spot Ø at max. range [mm]	Output H = light-on D = dark-on	Wiring diagr. no.	Draw- ing no.	Order no.
------	---------------------	-------	---------------	---------------------------	---------------------------------------	-------------------------	---------------------	--------------



Through-beam sensor · M8 connector · 10...30 DC · plastics · IP67 · Connector groups 4, 5, 80, 86, 147

	Transmitter	10 m	Red	1000	–	2	39	OJ5108
	Receiver	10 m	Red	–	H/D PNP	22	39	OJ5109

Retro-reflective sensor · M8 connector · 10...30 DC · plastics · IP67 · Connector groups 4, 5, 80, 86, 147

	Polarisation filter	0...2 m	Red	64	H/D PNP	22	39	OJ5104
---	---------------------	---------	-----	----	---------	----	----	---------------



Diffuse reflection sensor · M8 connector · 10...30 DC · plastics · IP67 · Connector groups 4, 5, 80, 86, 147

	Diffuse reflection sensor	1...600 mm	Red	60	H/D PNP	22	40	OJ5100
	Background suppression	15...400 mm	Red	< 18	H/D PNP	22	41	OJ5144

Rectangular plastic housing in O6 design









Type	Operating principle	Range	Type of light	Spot Ø at max. range [mm]	Output H = light-on D = dark-on	Wiring diagr. no.	Draw- ing no.	Order no.
------	---------------------	-------	---------------	---------------------------	---------------------------------------	-------------------------	---------------------	--------------











Through-beam sensor · Cable 2 m · 10...30 DC · plastics · IP65 / IP67

	Transmitter	10 m	Red	300	–	1	42	O6S200
	Receiver	10 m	Red	–	H/D PNP	10	43	O6E200
	Receiver	10 m	Red	–	H/D NPN	23	43	O6E204











Position sensors

Type	Operating principle	Range	Type of light	Spot Ø at max. range [mm]	Output H = light-on D = dark-on	Wiring diagr. no.	Draw- ing no.	Order no.
Through-beam sensor · Cable 0.3 m · with M12 connector, 4 poles · 10...30 DC · plastics · IP65 / IP67 · Connector groups 8, 10, 19, 21, 23, 25, 148, 149, 153, 184, 188, 193, 202								
	Transmitter	10 m	Red	300	–	2	42	O6S201
Through-beam sensor · Cable 0.3 m · with M12 connector, 4 poles · 10...30 DC · plastics · IP65 / IP67 · Connector groups 8, 10, 11, 18, 19, 21, 23, 25, 148, 149, 150, 153, 154, 184, 188, 190, 193, 202, 203, 204								
	Receiver	10 m	Red	–	H/D PNP	3	43	O6E201
Through-beam sensor · Cable 0.3 m · with M12 connector, 4 poles · 10...30 DC · plastics · IP65 / IP67 · Connector groups 8, 10, 19, 21, 23, 25, 148, 149, 153, 184, 188, 193, 202								
	Receiver	10 m	Red	–	H/D NPN	5	43	O6E205
Through-beam sensor · M8 connector, 3 poles · 10...30 DC · plastics · IP65 / IP67 · Connector groups 1, 3, 78, 84, 145								
	Transmitter	10 m	Red	300	–	2	44	O6S202
Through-beam sensor · M8 connector, 3 poles · 10...30 DC · plastics · IP65 / IP67 · Connector groups 1, 2, 3, 78, 84, 145, 146								
	Receiver	10 m	Red	–	H/D PNP	3	45	O6E202
Through-beam sensor · M8 connector, 4 poles · 10...30 DC · plastics · IP65 / IP67 · Connector groups 4, 5, 80, 86, 147								
	Receiver	10 m	Red	–	H/D PNP	3	45	O6E203
Through-beam sensor · M8 connector, 3 poles · 10...30 DC · plastics · IP65 / IP67 · Connector groups 1, 3, 78, 84, 145								
	Receiver	10 m	Red	–	H/D NPN	5	45	O6E206
Through-beam sensor · M8 connector, 4 poles · 10...30 DC · plastics · IP65 / IP67 · Connector groups 4, 5, 80, 86, 147								
	Receiver	10 m	Red	–	H/D NPN	5	45	O6E207
	Receiver	15 m	Infrared	–	H/D NPN	24	45	O6E216
	Receiver	15 m	Infrared	–	H/D PNP	3	45	O6E215
Diffuse reflection sensor · Cable 2 m · 10...30 DC · plastics · IP65 / IP67								
	Background suppression	2...200 mm	Red	8	H/D PNP	10	46	O6H200

Type	Operating principle	Range	Type of light	Spot Ø at max. range [mm]	Output H = light-on D = dark-on	Wiring diagr. no.	Draw- ing no.	Order no.
Diffuse reflection sensor · Cable 0.3 m · with M12 connector, 4 poles · 10...30 DC · plastics · IP65 / IP67 · Connector groups 8, 10, 11, 18, 19, 21, 23, 25, 148, 149, 150, 153, 154, 184, 188, 190, 193, 202, 203, 204								
	Background suppression	2...200 mm	Red	8	H/D PNP	3	46	O6H201
Diffuse reflection sensor · M8 connector, 3 poles · 10...30 DC · plastics · IP65 / IP67 · Connector groups 1, 2, 3, 78, 84, 145, 146								
	Background suppression	2...200 mm	Red	8	H/D PNP	3	47	O6H202
Diffuse reflection sensor · M8 connector, 4 poles · 10...30 DC · plastics · IP65 / IP67 · Connector groups 4, 5, 80, 86, 147								
	Background suppression	2...200 mm	Red	8	H/D PNP	3	47	O6H203
Diffuse reflection sensor · Cable 2 m · 10...30 DC · plastics · IP65 / IP67								
	Background suppression	2...200 mm	Red	8	H/D NPN	23	46	O6H204
Diffuse reflection sensor · Cable 0.3 m · with M12 connector, 4 poles · 10...30 DC · plastics · IP65 / IP67 · Connector groups 8, 10, 19, 21, 23, 25, 148, 149, 153, 184, 188, 193, 202								
	Background suppression	2...200 mm	Red	8	H/D NPN	5	46	O6H205
Diffuse reflection sensor · M8 connector, 3 poles · 10...30 DC · plastics · IP65 / IP67 · Connector groups 1, 3, 78, 84, 145								
	Background suppression	2...200 mm	Red	8	H/D NPN	5	47	O6H206
Diffuse reflection sensor · M8 connector, 4 poles · 10...30 DC · plastics · IP65 / IP67 · Connector groups 4, 5, 80, 86, 147								
	Background suppression	2...200 mm	Red	8	H/D NPN	5	47	O6H207
Retro-reflective sensor · Cable 2 m · 10...30 DC · plastics · IP65 / IP67								
	Polarisation filter	0.05...5 m	Red	150	H/D PNP	10	46	O6P200
Retro-reflective sensor · Cable 0.3 m · with M12 connector, 4 poles · 10...30 DC · plastics · IP65 / IP67 · Connector groups 8, 10, 11, 18, 19, 21, 23, 25, 148, 149, 150, 153, 154, 184, 188, 190, 193, 202, 203, 204								
	Polarisation filter	0.05...5 m	Red	150	H/D PNP	3	46	O6P201
Retro-reflective sensor · M8 connector, 3 poles · 10...30 DC · plastics · IP65 / IP67 · Connector groups 1, 2, 3, 78, 84, 145, 146								
	Polarisation filter	0.05...5 m	Red	150	H/D PNP	3	47	O6P202



Position sensors

Type	Operating principle	Range	Type of light	Spot Ø at max. range [mm]	Output H = light-on D = dark-on	Wiring diagr. no.	Draw- ing no.	Order no.
Retro-reflective sensor · M8 connector, 4 poles · 10...30 DC · plastics · IP65 / IP67 · Connector groups 4, 5, 80, 86, 147								
	Polarisation filter	0.05...5 m	Red	150	H/D PNP	3	47	O6P203
Retro-reflective sensor · Cable 2 m · 10...30 DC · plastics · IP65 / IP67								
	Polarisation filter	0.05...5 m	Red	150	H/D NPN	23	46	O6P204
Retro-reflective sensor · Cable 0.3 m · with M12 connector, 4 poles · 10...30 DC · plastics · IP65 / IP67 · Connector groups 8, 10, 19, 21, 23, 25, 148, 149, 153, 184, 188, 193, 202								
	Polarisation filter	0.05...5 m	Red	150	H/D NPN	5	46	O6P205
Retro-reflective sensor · M8 connector, 3 poles · 10...30 DC · plastics · IP65 / IP67 · Connector groups 1, 3, 78, 84, 145								
	Polarisation filter	0.05...5 m	Red	150	H/D NPN	5	47	O6P206
Retro-reflective sensor · M8 connector, 4 poles · 10...30 DC · plastics · IP65 / IP67 · Connector groups 4, 5, 80, 86, 147								
	Polarisation filter	0.05...5 m	Red	150	H/D NPN	5	47	O6P207
Through-beam sensor · M8 connector, 4 poles · 10...30 DC · plastics · IP65 / IP67 · Connector groups 4, 5, 80, 86, 147								
	Transmitter	10 m	Red	300	–	2	44	O6S203
	Transmitter	15 m	Infrared	460	–	2	44	O6S215
Diffuse reflection sensor · Cable 2 m · 10...30 DC · plastics · IP65 / IP67								
	Diffuse reflection sensor	5...500 mm	Red	15	H/D PNP	10	46	O6T200
Diffuse reflection sensor · Cable 0.3 m · with M12 connector, 4 poles · 10...30 DC · plastics · IP65 / IP67 · Connector groups 8, 10, 11, 18, 19, 21, 23, 25, 148, 149, 150, 153, 154, 184, 188, 190, 193, 202, 203, 204								
	Diffuse reflection sensor	5...500 mm	Red	15	H/D PNP	3	46	O6T201
Diffuse reflection sensor · M8 connector, 3 poles · 10...30 DC · plastics · IP65 / IP67 · Connector groups 1, 2, 3, 78, 84, 145, 146								
	Diffuse reflection sensor	5...500 mm	Red	15	H/D PNP	3	47	O6T202

Type	Operating principle	Range	Type of light	Spot Ø at max. range [mm]	Output H = light-on D = dark-on	Wiring diagr. no.	Draw- ing no.	Order no.
------	---------------------	-------	---------------	---------------------------	---------------------------------------	-------------------------	---------------------	--------------

Diffuse reflection sensor · M8 connector, 4 poles · 10...30 DC · plastics · IP65 / IP67 · Connector groups 4, 5, 80, 86, 147

	Diffuse reflection sensor	5...500 mm	Red	15	H/D PNP	3	47	O6T203
---	---------------------------	------------	-----	----	---------	---	----	--------

Diffuse reflection sensor · Cable 2 m · 10...30 DC · plastics · IP65 / IP67

	Diffuse reflection sensor	5...500 mm	Red	15	H/D NPN	23	46	O6T204
---	---------------------------	------------	-----	----	---------	----	----	--------

Diffuse reflection sensor · Cable 0.3 m · with M12 connector, 4 poles · 10...30 DC · plastics · IP65 / IP67 · Connector groups 8, 10, 19, 21, 23, 25, 148, 149, 153, 184, 188, 193, 202

	Diffuse reflection sensor	5...500 mm	Red	15	H/D NPN	5	46	O6T205
---	---------------------------	------------	-----	----	---------	---	----	--------

Diffuse reflection sensor · M8 connector, 3 poles · 10...30 DC · plastics · IP65 / IP67 · Connector groups 1, 3, 78, 84, 145

	Diffuse reflection sensor	5...500 mm	Red	15	H/D NPN	5	47	O6T206
--	---------------------------	------------	-----	----	---------	---	----	--------

Diffuse reflection sensor · M8 connector, 4 poles · 10...30 DC · plastics · IP65 / IP67 · Connector groups 4, 5, 80, 86, 147

	Diffuse reflection sensor	5...500 mm	Red	15	H/D NPN	5	47	O6T207
	Diffuse reflection sensor	5...600 mm	Infrared	24	H/D NPN	24	47	O6T216
	Diffuse reflection sensor	5...600 mm	Infrared	24	H/D PNP	3	47	O6T215

Rectangular housing O6 PerformanceLine, WetLine for hygienic and wet areas

Type	Operating principle	Range	Type of light	Spot Ø at max. range [mm]	Output H = light-on D = dark-on	Wiring diagr. no.	Draw- ing no.	Order no.
------	---------------------	-------	---------------	---------------------------	---------------------------------------	-------------------------	---------------------	--------------

Through-beam sensor · Cable 2 m · 10...30 DC · high-grade stainless steel · IP65 / IP67 / IP68 / IP69K

	Transmitter	10 m	Red	300	–	1	48	O6S300
---	-------------	------	-----	-----	---	---	----	--------











	Receiver	10 m	Red	–	H/D PNP	10	49	O6E300
---	----------	------	-----	---	---------	----	----	--------









Through-beam sensor · Cable 0.3 m · with M12 connector · 10...30 DC · high-grade stainless steel · IP65 / IP67 / IP68 / IP69K · Connector groups 148, 150, 153, 154, 184, 188, 190, 193

	Receiver	10 m	Red	–	H/D PNP	3	49	O6E301
---	----------	------	-----	---	---------	---	----	--------











Position sensors









Type	Operating principle	Range	Type of light	Spot Ø at max. range [mm]	Output H = light-on D = dark-on	Wiring diagr. no.	Draw- ing no.	Order no.
Through-beam sensor · M8 connector · 10...30 DC · high-grade stainless steel · IP65 / IP67 / IP68 / IP69K · Connector group 145								
	Transmitter	10 m	Red	300	–	2	50	O6S302
Through-beam sensor · M8 connector · 10...30 DC · high-grade stainless steel · IP65 / IP67 / IP68 / IP69K · Connector groups 145, 146								
	Receiver	10 m	Red	–	H/D PNP	3	51	O6E302
Through-beam sensor · M8 connector · 10...30 DC · high-grade stainless steel · IP65 / IP67 / IP68 / IP69K · Connector group 147								
	Receiver	10 m	Red	–	H/D PNP	3	51	O6E303
Through-beam sensor · Cable 0.3 m · with M12 connector · 10...30 DC · high-grade stainless steel · IP65 / IP67 / IP68 / IP69K · Connector groups 148, 153, 184, 188, 193								
	Transmitter	10 m	Red	300	–	2	48	O6S301
Through-beam sensor · Cable 2 m · 10...30 DC · high-grade stainless steel · IP65 / IP67 / IP68 / IP69K								
	Receiver	10 m	Red	–	H/D NPN	23	49	O6E304
Through-beam sensor · M8 connector · 10...30 DC · high-grade stainless steel · IP65 / IP67 / IP68 / IP69K · Connector group 147								
	Transmitter	10 m	Red	300	–	25	50	O6S305
Through-beam sensor · Cable 0.3 m · with M12 connector · 10...30 DC · high-grade stainless steel · IP65 / IP67 / IP68 / IP69K · Connector groups 148, 153, 184, 188, 193								
	Receiver	10 m	Red	–	H/D NPN	5	49	O6E305
Through-beam sensor · M8 connector · 10...30 DC · high-grade stainless steel · IP65 / IP67 / IP68 / IP69K · Connector group 147								
	Transmitter	10 m	Red	300	–	2	50	O6S303
	Receiver	10 m	Red	–	H/D PNP	3	51	O6E309
Through-beam sensor · M8 connector · 10...30 DC · high-grade stainless steel · IP65 / IP67 / IP68 / IP69K · Connector group 145								
	Receiver	10 m	Red	–	H/D NPN	5	51	O6E306

Type	Operating principle	Range	Type of light	Spot Ø at max. range [mm]	Output H = light-on D = dark-on	Wiring diagr. no.	Draw- ing no.	Order no.
Through-beam sensor · M8 connector · 10...30 DC · high-grade stainless steel · IP65 / IP67 / IP68 / IP69K · Connector group 147								
	Receiver	10 m	Red	–	H/D NPN	5	51	O6E307
Diffuse reflection sensor · Cable 2 m · 10...30 DC · high-grade stainless steel · IP65 / IP67 / IP68 / IP69K								
	Background suppression	2...200 mm	Red	8	H/D PNP	10	52	O6H300
Diffuse reflection sensor · Cable 0.3 m · with M12 connector · 10...30 DC · high-grade stainless steel · IP65 / IP67 / IP68 / IP69K · Connector groups 148, 150, 153, 154, 184, 188, 190, 193								
	Background suppression	2...200 mm	Red	8	H/D PNP	3	52	O6H301
Diffuse reflection sensor · M8 connector · 10...30 DC · high-grade stainless steel · IP65 / IP67 / IP68 / IP69K · Connector groups 145, 146								
	Background suppression	2...200 mm	Red	8	H/D PNP	3	53	O6H302
Diffuse reflection sensor · M8 connector · 10...30 DC · high-grade stainless steel · IP65 / IP67 / IP68 / IP69K · Connector group 147								
	Background suppression	2...200 mm	Red	8	H/D PNP	3	53	O6H303
Diffuse reflection sensor · Cable 2 m · 10...30 DC · high-grade stainless steel · IP65 / IP67 / IP68 / IP69K								
	Background suppression	2...200 mm	Red	8	H/D NPN	23	52	O6H304
Diffuse reflection sensor · Cable 0.3 m · with M12 connector · 10...30 DC · high-grade stainless steel · IP65 / IP67 / IP68 / IP69K · Connector groups 148, 153, 184, 188, 193								
	Background suppression	2...200 mm	Red	8	H/D NPN	5	52	O6H305
Diffuse reflection sensor · M8 connector · 10...30 DC · high-grade stainless steel · IP65 / IP67 / IP68 / IP69K · Connector group 145								
	Background suppression	2...200 mm	Red	8	H/D NPN	5	53	O6H306
Diffuse reflection sensor · M8 connector · 10...30 DC · high-grade stainless steel · IP65 / IP67 / IP68 / IP69K · Connector group 147								
	Background suppression	2...200 mm	Red	8	H/D NPN	5	53	O6H307
	Background suppression	2...200 mm	Red	8	H/D PNP	3	53	O6H309



Position sensors

Type	Operating principle	Range	Type of light	Spot Ø at max. range [mm]	Output H = light-on D = dark-on	Wiring diagr. no.	Draw- ing no.	Order no.
Diffuse reflection sensor · M8 connector · 10...30 DC · plastics · IP65 / IP67 · Connector groups 4, 5, 80, 86, 147								
	Background suppression	2...200 mm	Red	8	H+D PNP	26	54	O6H210
	Background suppression	100 mm	Red	6	H PNP	3	55	O6H211
	Background suppression	200 mm	Red	8	H PNP	3	55	O6H212
	Background suppression	100 mm	Red	6	H NPN	5	55	O6H213
	Background suppression	200 mm	Red	8	H NPN	5	55	O6H214
Diffuse reflection sensor · M8 connector · 10...30 DC · high-grade stainless steel · IP65 / IP67 / IP68 / IP69K · Connector group 147								
	Background suppression	2...200 mm	Red	8	H+D PNP	26	56	O6H310
Retro-reflective sensor · Cable 2 m · 10...30 DC · high-grade stainless steel · IP65 / IP67 / IP68 / IP69K								
	Polarisation filter	0.05...5 m	Red	150	H/D PNP	10	52	O6P300
Retro-reflective sensor · Cable 0.3 m · with M12 connector · 10...30 DC · high-grade stainless steel · IP65 / IP67 / IP68 / IP69K · Connector groups 148, 150, 153, 154, 184, 188, 190, 193								
	Polarisation filter	0.05...5 m	Red	150	H/D PNP	3	52	O6P301
Retro-reflective sensor · M8 connector · 10...30 DC · high-grade stainless steel · IP65 / IP67 / IP68 / IP69K · Connector groups 145, 146								
	Polarisation filter	0.05...5 m	Red	150	H/D PNP	3	53	O6P302
Retro-reflective sensor · M8 connector · 10...30 DC · high-grade stainless steel · IP65 / IP67 / IP68 / IP69K · Connector group 147								
	Polarisation filter	0.05...5 m	Red	150	H/D PNP	3	53	O6P303
Retro-reflective sensor · Cable 2 m · 10...30 DC · high-grade stainless steel · IP65 / IP67 / IP68 / IP69K								
	Polarisation filter	0.05...5 m	Red	150	H/D NPN	23	52	O6P304
Retro-reflective sensor · Cable 0.3 m · with M12 connector · 10...30 DC · high-grade stainless steel · IP65 / IP67 / IP68 / IP69K · Connector groups 148, 153, 184, 188, 193								
	Polarisation filter	0.05...5 m	Red	150	H/D NPN	5	52	O6P305

Type	Operating principle	Range	Type of light	Spot Ø at max. range [mm]	Output H = light-on D = dark-on	Wiring diagr. no.	Draw- ing no.	Order no.
Retro-reflective sensor · M8 connector · 10...30 DC · high-grade stainless steel · IP65 / IP67 / IP68 / IP69K · Connector group 145								
	Polarisation filter	0.05...5 m	Red	150	H/D NPN	5	53	O6P306
Retro-reflective sensor · M8 connector · 10...30 DC · high-grade stainless steel · IP65 / IP67 / IP68 / IP69K · Connector group 147								
	Polarisation filter	0.05...5 m	Red	150	H/D NPN	5	53	O6P307
	Polarisation filter	0.05...5 m	Red	150	H/D PNP	3	53	O6P309
	Polarisation filter	0.05...5 m	Red	150	H+D PNP	27	56	O6P310
Diffuse reflection sensor · Cable 2 m · 10...30 DC · high-grade stainless steel · IP65 / IP67 / IP68 / IP69K								
	Diffuse reflection sensor	5...500 mm	Red	15	H/D PNP	10	52	O6T300
Diffuse reflection sensor · Cable 0.3 m · with M12 connector · 10...30 DC · high-grade stainless steel · IP65 / IP67 / IP68 / IP69K · Connector groups 148, 150, 153, 154, 184, 188, 190, 193								
	Diffuse reflection sensor	5...500 mm	Red	15	H/D PNP	3	52	O6T301
Diffuse reflection sensor · M8 connector · 10...30 DC · high-grade stainless steel · IP65 / IP67 / IP68 / IP69K · Connector groups 145, 146								
	Diffuse reflection sensor	5...500 mm	Red	15	H/D PNP	3	53	O6T302
Diffuse reflection sensor · M8 connector · 10...30 DC · high-grade stainless steel · IP65 / IP67 / IP68 / IP69K · Connector group 147								
	Diffuse reflection sensor	5...500 mm	Red	15	H/D PNP	3	53	O6T303
Diffuse reflection sensor · Cable 2 m · 10...30 DC · high-grade stainless steel · IP65 / IP67 / IP68 / IP69K								
	Diffuse reflection sensor	5...500 mm	Red	15	H/D NPN	23	52	O6T304
Diffuse reflection sensor · Cable 0.3 m · with M12 connector · 10...30 DC · high-grade stainless steel · IP65 / IP67 / IP68 / IP69K · Connector groups 148, 153, 184, 188, 193								
	Diffuse reflection sensor	5...500 mm	Red	15	H/D NPN	5	52	O6T305
Diffuse reflection sensor · M8 connector · 10...30 DC · high-grade stainless steel · IP65 / IP67 / IP68 / IP69K · Connector group 145								
	Diffuse reflection sensor	5...500 mm	Red	15	H/D NPN	5	53	O6T306



Position sensors

Type	Operating principle	Range	Type of light	Spot Ø at max. range [mm]	Output H = light-on D = dark-on	Wiring diagr. no.	Draw- ing no.	Order no.
------	---------------------	-------	---------------	---------------------------	---------------------------------------	-------------------------	---------------------	--------------

Diffuse reflection sensor · M8 connector · 10...30 DC · high-grade stainless steel · IP65 / IP67 / IP68 / IP69K · Connector group 147

	Diffuse reflection sensor	5...500 mm	Red	15	H/D NPN	5	53	O6T307
	Diffuse reflection sensor	5...500 mm	Red	15	H/D PNP	3	53	O6T309

Rectangular O6 design for oils and coolants

Type	Operating principle	Range	Type of light	Spot Ø at max. range [mm]	Output H = light-on D = dark-on	Wiring diagr. no.	Draw- ing no.	Order no.
------	---------------------	-------	---------------	---------------------------	---------------------------------------	-------------------------	---------------------	--------------

Through-beam sensor · M8 connector · 10...30 DC · high-grade stainless steel · IP65 / IP67 ; IP68 · Connector groups 4, 5

	Transmitter	10 m	Red	300	–	2	50	O6S400
	Receiver	10 m	Red	–	H/D PNP	3	51	O6E400
	Receiver	10 m	Red	–	H/D NPN	5	51	O6E401

Diffuse reflection sensor · M8 connector · 10...30 DC · high-grade stainless steel · IP65 / IP67 ; IP68 · Connector groups 4, 5

	Background suppression	2...200 mm	Red	8	H/D PNP	3	53	O6H400
	Background suppression	2...200 mm	Red	8	H/D NPN	5	53	O6H401





Retro-reflective sensor · M8 connector · 10...30 DC · high-grade stainless steel · IP65 / IP67 ; IP68 · Connector groups 4, 5

	Polarisation filter	0.05...5 m	Red	150	H/D PNP	3	53	O6P400
	Polarisation filter	0.05...5 m	Red	150	H/D NPN	5	53	O6P401





Diffuse reflection sensor · M8 connector · 10...30 DC · high-grade stainless steel · IP65 / IP67 ; IP68 · Connector groups 4, 5

	Diffuse reflection sensor	5...500 mm	Red	15	H/D PNP	3	53	O6T400
	Diffuse reflection sensor	5...500 mm	Red	15	H/D NPN	5	53	O6T401

Rectangular housing O5 BasicLine

Type	Operating principle	Range	Type of light	Spot Ø at max. range [mm]	Output H = light-on D = dark-on	Wiring diagr. no.	Draw- ing no.	Order no.
Through-beam sensor · M12 connector · 10...36 DC · plastics · IP67 · Connector groups 8, 10, 19, 21, 23, 25, 148, 149, 153, 184, 188, 193, 202								
	Transmitter	20 m	Red	500	–	2	57	O5S200
Through-beam sensor · M12 connector · 10...36 DC · plastics · IP67 · Connector groups 8, 10, 11, 18, 19, 21, 23, 25, 148, 149, 150, 153, 154, 184, 188, 190, 193, 202, 203, 204								
	Receiver	20 m	Red	–	D PNP	14	57	O5E200
Retro-reflective sensor · M12 connector · 10...36 DC · plastics · IP67 · Connector groups 8, 10, 11, 18, 19, 21, 23, 25, 148, 149, 150, 153, 154, 184, 188, 190, 193, 202, 203, 204								
	Polarisation filter	0.1...7 m	Red	175	D PNP	14	58	O5P200
Retro-reflective sensor · M12 connector · 10...36 DC · plastics · IP67 · Connector groups 8, 9, 10, 11, 18, 19, 21, 23, 25, 148, 149, 150, 151, 153, 154, 184, 188, 190, 193, 202, 203, 204								
	Polarisation filter	0.1...7 m	Red	175	H PNP	28	58	O5P201
Diffuse reflection sensor · M12 connector · 10...36 DC · plastics · IP65 · Connector groups 8, 10, 11, 18, 19, 21, 23, 25, 148, 149, 150, 153, 154, 184, 188, 190, 193, 202, 203, 204								
	Background suppression	50...1400 mm	Red	50	H PNP	4	59	O5H200

Rectangular housing O5 PerformanceLine

Type	Operating principle	Range	Type of light	Spot Ø at max. range [mm]	Output H = light-on D = dark-on	Wiring diagr. no.	Draw- ing no.	Order no.
Through-beam sensor · Cable 2 m · 10...36 DC · plastics · IP67								
	Transmitter	25 m	Red	625	–	1	60	O5S501
	Receiver	25 m	Red	–	H/D PNP	10	61	O5E501
Through-beam sensor · M12 connector · 10...36 DC · plastics · IP67 · Connector groups 8, 10, 19, 21, 23, 25, 148, 149, 153, 184, 188, 193, 202								
	Transmitter	25 m	Red	625	–	2	57	O5S500
Through-beam sensor · M12 connector · 10...36 DC · plastics · IP67 · Connector groups 8, 10, 11, 18, 19, 21, 23, 25, 148, 149, 150, 153, 154, 184, 188, 190, 193, 202, 203, 204								
	Receiver	25 m	Red	–	H/D PNP	3	62	O5E500



Position sensors

Type	Operating principle	Range	Type of light	Spot Ø at max. range [mm]	Output H = light-on D = dark-on	Wiring diagr. no.	Draw- ing no.	Order no.
------	---------------------	-------	---------------	---------------------------	---------------------------------------	-------------------------	---------------------	--------------

Through-beam sensor · M12 connector · 10...36 DC · plastics · IP67 · Connector groups 8, 10, 19, 21, 23, 25, 148, 149, 153, 184, 188, 193, 202



Receiver	25 m	Red	–	H/D NPN	5	62	O5E502
----------	------	-----	---	---------	---	----	---------------

Retro-reflective sensor · Cable 2 m · 10...36 DC · plastics · IP67



Polarisation filter	0.075...10 m	Red	250	H/D PNP	10	63	O5P501
---------------------	--------------	-----	-----	---------	----	----	---------------

Retro-reflective sensor · M12 connector · 10...36 DC · plastics · IP67 · Connector groups 8, 10, 11, 18, 19, 21, 23, 25, 148, 149, 150, 153, 154, 184, 188, 190, 193, 202, 203, 204



Polarisation filter	0.075...10 m	Red	250	H/D PNP	3	64	O5P500
---------------------	--------------	-----	-----	---------	---	----	---------------

Retro-reflective sensor · M12 connector · 10...36 DC · plastics · IP67 · Connector groups 8, 10, 19, 21, 23, 25, 148, 149, 153, 184, 188, 193, 202



Polarisation filter	0.075...10 m	Red	250	H/D NPN	5	64	O5P502
---------------------	--------------	-----	-----	---------	---	----	---------------

Diffuse reflection sensor · Cable 2 m · 10...36 DC · plastics · IP67



Background suppression	50...1800 mm	Red	50	H/D PNP	10	63	O5H503
------------------------	--------------	-----	----	---------	----	----	---------------

Diffuse reflection sensor · M12 connector · 10...36 DC · plastics · IP67 · Connector groups 8, 10, 11, 18, 19, 21, 23, 25, 148, 149, 150, 153, 154, 184, 188, 190, 193, 202, 203, 204



Background suppression	50...1800 mm	Red	50	H/D PNP	3	64	O5H500
------------------------	--------------	-----	----	---------	---	----	---------------

Background suppression	60...700 mm	Red	35	H/D PNP	3	64	O5H501
------------------------	-------------	-----	----	---------	---	----	---------------

Diffuse reflection sensor · M12 connector · 10...36 DC · plastics · IP67 · Connector groups 8, 10, 19, 21, 23, 25, 148, 149, 153, 184, 188, 193, 202



Background suppression	50...1800 mm	Red	50	H/D NPN	5	64	O5H504
------------------------	--------------	-----	----	---------	---	----	---------------

Rectangular housing O5 PerformanceLine with ATEX approval 3D

Type	Operating principle	Range	Type of light	Spot Ø at max. range [mm]	Output H = light-on D = dark-on	Wiring diagr. no.	Draw- ing no.	Order no.
------	---------------------	-------	---------------	---------------------------	---------------------------------------	-------------------------	---------------------	--------------

Through-beam sensor · M12 connector · 10...30 DC · plastics · IP65 · Connector groups 196, 198



Transmitter	25 m	Red	625	–	2	65	O5S51A
-------------	------	-----	-----	---	---	----	---------------

Receiver	25 m	Red	–	H/D PNP	3	65	O5E51A
----------	------	-----	---	---------	---	----	---------------

Type	Operating principle	Range	Type of light	Spot Ø at max. range [mm]	Output H = light-on D = dark-on	Wiring diagr. no.	Draw- ing no.	Order no.
------	---------------------	-------	---------------	---------------------------	---------------------------------------	-------------------------	---------------------	--------------

Retro-reflective sensor · M12 connector · 10...30 DC · plastics · IP65 · Connector groups 196, 198

	Polarisation filter	0.075...10 m	Red	250	H/D PNP	3	65	O5P51A
---	---------------------	--------------	-----	-----	---------	---	----	---------------

Diffuse reflection sensor · M12 connector · 10...30 DC · plastics · IP65 · Connector groups 196, 198

	Background suppression	50...1800 mm	Red	50	H/D PNP	3	65	O5H51A
---	------------------------	--------------	-----	----	---------	---	----	---------------

Rectangular OA design with relay output

Type	Operating principle	Range	Type of light	Spot Ø at max. range [mm]	Output H = light-on D = dark-on	Wiring diagr. no.	Draw- ing no.	Order no.
------	---------------------	-------	---------------	---------------------------	---------------------------------------	-------------------------	---------------------	--------------

Retro-reflective sensor · Terminals · 20...250 AC/DC (47...63 Hz AC) · plastics · IP65

	Polarisation filter	0.2...8 m	Red	420	H/D Relay	29	66	OA0106*
--	---------------------	-----------	-----	-----	-----------	----	----	----------------

Diffuse reflection sensor · Terminals · 20...250 AC/DC (47...63 Hz AC) · plastics · IP65

	Diffuse reflection sensor	5...1500 mm	Infrared	370	H/D Relay	29	66	OA0108*
---	---------------------------	-------------	----------	-----	-----------	----	----	----------------

Through-beam sensor · Terminals · 20...250 AC/DC (47...63 Hz AC) · plastics · IP65

	Transmitter	50 m	Infrared	1500	–	30	66	OA0101
	Receiver	25...50 m	Infrared	–	H/D Relay	29	66	OA0102*

* Note on use of miniature fuses for electrical connection

Miniature fuse to IEC60127-2 sheet 1, ≤ 5 A (fast acting) Recommendation: check the unit for reliable function after a short circuit.

Rectangular housing O4 BasicLine



Type	Operating principle	Range	Type of light	Spot Ø at max. range [mm]	Output H = light-on D = dark-on	Wiring diagr. no.	Draw- ing no.	Order no.
------	---------------------	-------	---------------	---------------------------	---------------------------------------	-------------------------	---------------------	--------------

Through-beam sensor · M12 connector · 10...36 DC · plastics · IP67 · Connector groups 8, 10, 19, 21, 23, 25, 148, 149, 153, 184, 188, 193, 202



	Transmitter	0...50 m	Red	1000	–	2	67	O4S200
---	-------------	----------	-----	------	---	---	----	---------------



Position sensors

Type	Operating principle	Range	Type of light	Spot Ø at max. range [mm]	Output H = light-on D = dark-on	Wiring diagr. no.	Draw- ing no.	Order no.
Through-beam sensor · M12 connector · 10...36 DC · plastics · IP67 · Connector groups 8, 10, 11, 18, 19, 21, 23, 25, 148, 149, 150, 153, 154, 184, 188, 190, 193, 202, 203, 204								
	Receiver	0...50 m	Red	–	D PNP	14	68	O4E200
	Receiver	0...50 m	Red	–	H PNP	4	68	O4E201
Retro-reflective sensor · M12 connector · 10...36 DC · plastics · IP67 · Connector groups 8, 10, 11, 18, 19, 21, 23, 25, 148, 149, 150, 153, 154, 184, 188, 190, 193, 202, 203, 204								
	Polarisation filter	0.3...18 m	Red	500	D PNP	14	69	O4P200
	Polarisation filter	0.3...18 m	Red	500	H PNP	4	69	O4P201
Diffuse reflection sensor · M12 connector · 10...36 DC · plastics · IP65 · Connector groups 8, 10, 11, 18, 19, 21, 23, 25, 148, 149, 150, 153, 154, 184, 188, 190, 193, 202, 203, 204								
	Background suppression	100...2000 mm	Red	100	H PNP	4	70	O4H200
	Background suppression	100...2000 mm	Red	100	D PNP	14	70	O4H201

Rectangular housing O4 PerformanceLine

Type	Operating principle	Range	Type of light	Spot Ø at max. range [mm]	Output H = light-on D = dark-on	Wiring diagr. no.	Draw- ing no.	Order no.
Through-beam sensor · Cable 2 m · 10...36 DC · plastics · IP67								
	Transmitter	0...80 m	Red	2400	–	1	71	O4S501
	Receiver	0...80 m	Red	–	H/D PNP	10	72	O4E501
Through-beam sensor · M12 connector · 10...36 DC · plastics · IP67 · Connector groups 8, 10, 19, 21, 23, 25, 148, 149, 153, 184, 188, 193, 202								
	Transmitter	0...80 m	Red	2400	–	2	67	O4S500
Through-beam sensor · M12 connector · 10...36 DC · plastics · IP67 · Connector groups 8, 10, 11, 18, 19, 21, 23, 25, 148, 149, 150, 153, 154, 184, 188, 190, 193, 202, 203, 204								
	Receiver	0...80 m	Red	–	H/D PNP	3	73	O4E500

Type	Operating principle	Range	Type of light	Spot Ø at max. range [mm]	Output H = light-on D = dark-on	Wiring diagr. no.	Draw- ing no.	Order no.
------	---------------------	-------	---------------	---------------------------	---------------------------------------	-------------------------	---------------------	--------------

Retro-reflective sensor · Cable 2 m · 10...36 DC · plastics · IP67

	Polarisation filter	0.3...22 m	Red	660	H/D PNP	10	74	O4P501
---	---------------------	------------	-----	-----	---------	----	----	---------------

Retro-reflective sensor · M12 connector · 10...36 DC · plastics · IP67 · Connector groups 8, 10, 11, 18, 19, 21, 23, 25, 148, 149, 150, 153, 154, 184, 188, 190, 193, 202, 203, 204

	Polarisation filter	0.3...22 m	Red	660	H/D PNP	3	75	O4P500
---	---------------------	------------	-----	-----	---------	---	----	---------------

Diffuse reflection sensor · Cable 2 m · 10...36 DC · plastics · IP67

	Background suppression	100...2600 mm	Red	50	H/D PNP	10	76	O4H501
---	------------------------	---------------	-----	----	---------	----	----	---------------

Diffuse reflection sensor · M12 connector · 10...36 DC · plastics · IP67 · Connector groups 8, 10, 11, 18, 19, 21, 23, 25, 148, 149, 150, 153, 154, 184, 188, 190, 193, 202, 203, 204

	Background suppression	100...2600 mm	Red	50	H/D PNP	3	77	O4H500
--	------------------------	---------------	-----	----	---------	---	----	---------------

Prismatic reflectors, reflective tape and fixing components

Type	Description	Order no.
	Prismatic reflector · Ø 20 mm · round · For red light and infrared light retro-reflective sensors · Housing materials: plastics	E20003
	Prismatic reflector · Ø 25 mm · round · fixing by screw · For red light and infrared light retro-reflective sensors · Housing materials: plastics	E20953
	Prismatic reflector · Ø 35 mm · round · fixing by screw · For red light and infrared light retro-reflective sensors · Housing materials: plastics	E20954
	Prismatic reflector · Ø 42 mm · round · For red light and infrared light retro-reflective sensors · Housing materials: plastics	E20004
	Prismatic reflector · Ø 50 mm · round · fixing by screw · For red light and infrared light retro-reflective sensors · Housing materials: plastics	E20956
	Prismatic reflector · Ø 80 mm · round · For red light and infrared light retro-reflective sensors · Housing materials: plastics	E20005
	Prismatic reflector · 45 x 28 mm · rectangular · For red light and infrared light retro-reflective sensors · Housing materials: plastics	E20452



Position sensors

Type	Description	Order no.
	Prismatic reflector · 48 x 48 mm · rectangular · For red light and infrared light retro-reflective sensors · Housing materials: front plate: PMMA / base: ABS	E20744
	Prismatic reflector · 93 x 45 mm · rectangular · For red light and infrared light retro-reflective sensors · Housing materials: plastics	E20453
	Prismatic reflector · 96 x 96 mm · rectangular · For red light and infrared light retro-reflective sensors · Housing materials: plastics	E20454
	Prismatic reflector · 18 x 18 mm · rectangular · For red light and infrared light retro-reflective sensors · Housing materials: Solidchem	E21267
	Prismatic reflector · 56 x 38 mm · rectangular · For red light and infrared light retro-reflective sensors · Housing materials: Solidchem	E21268
	Prismatic reflector · 48 x 48 mm · rectangular · For red light and infrared light retro-reflective sensors · Housing materials: Solidchem	E21269
	Prismatic reflector · 96 x 96 mm · rectangular · For red light and infrared light retro-reflective sensors · Housing materials: Solidchem	E21270
	Mounting set · for reflector · Ø 25 mm · Clamp mounting · free-standing M8 · Housing materials: fixture: stainless steel 316Ti / 1.4571 / clamp: stainless steel	E20903
	Mounting set · for reflector · Ø 35 mm · Clamp mounting · free-standing M8 · Housing materials: fixture: stainless steel 316Ti / 1.4571 / clamp: stainless steel	E20907
	Mounting set · for reflector · Ø 50 mm · Clamp mounting · Free-standing M10 · Housing materials: fixture: stainless steel 316Ti / 1.4571 / clamp: stainless steel	E20911
	Mounting set · for reflector · Ø 80 mm · Clamp mounting · free-standing M12 · Housing materials: fixture: stainless steel 316Ti / 1.4571 / clamp: diecast zinc	E20914
	Mounting set · for reflector · Ø 80 mm · Clamp mounting · free-standing M12 · Housing materials: fixture: stainless steel 316Ti / 1.4571 / clamp: stainless steel	E20915
	Angle bracket · for reflector · 50 x 50 mm · Housing materials: fixture: stainless steel 316Ti / 1.4571	E20724
	Reflective tape · TS-02 · 50 x 1000 mm · For red light and infrared light retro-reflective sensors · Housing materials: plastics / acrylic	E21015



Software

Type	Description	Order no.
	LR DEVICE (USB stick) · Parameter setting of the units via the network · Software for clear online and offline parameter setting of IO-Link sensors via USB adapter · Use via USB connection cable (drivers are supplied): E30396 IO-Link interface or E30390 IO-Link master (note the respective data sheet) · IODD import and update from ifm's homepage · Reading of IODDs via storage media · Automatic sensor identification · Graphic representation of the process values and history incl. export function · Documentation and archiving · Transferable parameter sets · Full memory plug support for IO-Link 1.1	QA0011
	LR DEVICE (download) · Parameter setting of the units via the network · Software for clear online and offline parameter setting of IO-Link sensors via USB adapter · Use via USB connection cable (drivers are supplied): E30396 IO-Link interface or E30390 IO-Link master (note the respective data sheet) · IODD import and update from ifm's homepage · Reading of IODDs via storage media · Automatic sensor identification · Graphic representation of the process values and history incl. export function · Documentation and archiving · Transferable parameter sets · Full memory plug support for IO-Link 1.1	QA0012

Accessories OA

Type	Description	Order no.
	Mounting set · Clamp mounting · free-standing M12 · for type OA · Housing materials: fixture: stainless steel 316Ti / 1.4571 / clamp: diecast zinc	E20893

Accessories OF design (M12)

Type	Description	Order no.
	angle support · 90° · for type OF · Housing materials: housing: ABS / lens: PC	E20590
	Mounting set · Ø 12.2 mm · Clamp mounting · rod mounting Ø 10 mm · for type OF, IF · Housing materials: fixture: stainless steel 316Ti / 1.4571 / clamp: diecast zinc	E21200
	Mounting set · Ø 12.2 mm · Clamp mounting · rod mounting Ø 10 mm · for type OF, IF · Housing materials: fixture: stainless steel 316Ti / 1.4571 / clamp: stainless steel	E21201
	Mounting set · Ø 12.2 mm · Clamp mounting · rod mounting Ø 10 mm · for type OF, IF · Housing materials: fixture: stainless steel 316Ti / 1.4571 / clamp: diecast zinc	E21202
	Mounting set · Ø 12.2 mm · Clamp mounting · rod mounting Ø 10 mm · for type OF, IF · Housing materials: fixture: stainless steel 316Ti / 1.4571 / clamp: stainless steel	E21203

Accessories OG design (M18)









Type	Description	Order no.
	Angle bracket · for type M18 · Housing materials: stainless steel	E10736







Position sensors

Type	Description	Order no.
	Mounting set · Ø 18.5 mm · Clamp mounting · rod mounting Ø 12 mm · for type OG, IG, KG · Housing materials: clamp: diecast zinc / fixture: steel	E20720
	Mounting set · Ø 18.5 mm · Clamp mounting · rod mounting Ø 12 mm · for type OG, IG, KG · Housing materials: clamp: diecast zinc / fixture: steel	E20721
	Mounting set · Ø 18.5 mm · Clamp mounting · rod mounting Ø 12 mm · for type OG, IG, KG · Housing materials: clamp: high-grade stainless steel / fixture: high-grade stainless steel	E21206
	Mounting set · Ø 18.5 mm · Clamp mounting · rod mounting Ø 12 mm · for type OG, IG, KG · Housing materials: clamp: high-grade stainless steel / fixture: high-grade stainless steel	E21207









Accessories OI design (M30)

Type	Description	Order no.
	Angle bracket · for type M30 · Housing materials: stainless steel	E10737
	Mounting clamp · Ø 30 mm · with end stop · for type M30 · Housing materials: PC	E11049
	Mounting clamp · Ø 34 mm · Ø 30 mm · with reducing bush · for type M30 · Housing materials: PBT	E10077
	Mounting set · Ø 30.2 mm · Clamp mounting · aluminium profile · for type II, KI, OI, OI · Housing materials: fixture: stainless steel 316Ti / 1.4571 / clamp: diecast zinc / Cube: diecast zinc	E20875
	Mounting set · Ø 30.2 mm · Clamp mounting · free-standing M12 · for type OI, II, KI · Housing materials: fixture: stainless steel 316Ti / 1.4571 / clamp: diecast zinc	E20873
	Mounting set · Ø 30.2 mm · Clamp mounting · free-standing M12 · for type OI, II, KI · Housing materials: fixture: stainless steel 316Ti / 1.4571 / clamp: stainless steel	E20874
	mounting rod · Ø 12 / M10 · Length: 130 mm · straight · Housing materials: stainless steel 316Ti / 1.4571	E20938
	Cube · M10 · aluminium profile · Housing materials: diecast zinc	E20951
	Memory plug · Parameter memory for IO-Link sensors · Storage capacity: 2 Kbytes · Housing materials: PA PACM 12 / PET / sealing: FPM / nut: stainless steel 316L / 1.4404 / connector: TPU	E30398

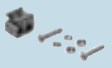
Accessories O7 housing

Type	Description	Order no.
	Mounting set · O7 · Clamp mounting · rod mounting Ø 10 mm · Housing materials: fixture: stainless steel / clamp: stainless steel / screw: stainless steel / nut: stainless steel	E21237
	Mounting set · O7 · Free-standing mounting · free-standing · Housing materials: fixture: stainless steel / screws: stainless steel	E21238
	Mounting set · O7 · Free-standing mounting · with fine adjustment · free-standing · Housing materials: fixture: stainless steel / Spring: spring steel / screws: stainless steel	E21239
	Mounting set · O7 · ball joint · free-standing · Housing materials: fixture: diecast zinc / mounting base: diecast zinc / screws: stainless steel	E21240

Accessories OJ housing

Type	Description	Order no.
	Angle bracket · for type OJ · Housing materials: high-grade stainless steel	E20984
	Basic clip · OJ · Housing materials: high-grade stainless steel	E20965
	Basic clip · OJ · Housing materials: diecast zinc	E20964
	Swivel-mount clip · for type OJ · Housing materials: diecast zinc	E20974
	Mounting set · OJ · for side lens · Clamp mounting · free-standing M8 · Housing materials: fixture: stainless steel 316Ti / 1.4571 / clamp: diecast zinc	E20968
	Mounting set · OJ · for side lens · Clamp mounting · free-standing M8 · Housing materials: fixture: stainless steel 316Ti / 1.4571 / clamp: stainless steel	E20969
	Mounting set · OJ · for side lens · rod mounting Ø 10 mm · Housing materials: clamp: diecast zinc / fixture: stainless steel 316Ti / 1.4571	E21095
	Mounting set · OJ · for side lens · Clamp mounting · rod mounting Ø 10 mm · Housing materials: fixture: stainless steel 316Ti / 1.4571 / clamp: diecast zinc	E21222
	Mounting set · OJ · for front lens · Clamp mounting · free-standing M8 · Housing materials: clamp: diecast zinc / fixture: stainless steel 316Ti / 1.4571	E20966









Position sensors



Type	Description	Order no.
	Mounting set · OJ · for front lens · Clamp mounting · rod mounting · Housing materials: fixture: stainless steel 316Ti / 1.4571 / clamp: stainless steel	E21221

Accessories for O6 design





Type	Description	Order no.
	Angle bracket · O6 · for type O6 · Housing materials: stainless steel 316Ti / 1.4571	E21271
	Mounting set · O6 · Clamp mounting · rod mounting Ø 10 mm · for type O6 · Housing materials: stainless steel 316Ti / 1.4571	E21272
	Protective cover · O6 · for type O6 · Housing materials: stainless steel 316Ti / 1.4571	E21273
	Pinhole mask · 0.5 mm · for type O6E / O6S plastic · Housing materials: stainless steel	E21277
	Slot mask · 0.5 x 8 mm · for type O6E / O6S plastic · Housing materials: stainless steel	E21280

Accessories O5 housing

Type	Description	Order no.
	Angle bracket · for type O5 · Housing materials: stainless steel 316Ti / 1.4571	E21087
	Angle bracket · for type O5 · Housing materials: stainless steel 316Ti / 1.4571	E21085
	Angle bracket · O5, O4 · for mounting O5, O4 sensors instead of OL sensors · Dovetail clamp · Housing materials: Dovetail clamp: AlMgSi0.5 / fixture: AlMg3	E21122
	Dovetail clamp · for type DTS, O4, O5 · Housing materials: AlMgSi0.5	E21088
	Mounting brackets Mounting on the back of the unit · for type O5 · Housing materials: stainless steel 316Ti / 1.4571	E21086
	Mounting sleeve · O5 · for mounting O5 sensors instead of OC sensors · Housing materials: AlZnMgCu1.5 F51/52	E21114







Type	Description	Order no.
	Mounting set · Clamp mounting · With protective cover · rod mounting Ø 12 mm · for type O5 · Housing materials: fixture: stainless steel 316Ti / 1.4571 / clamp: high-grade stainless steel	E21223
	Mounting set · Clamp mounting · With protective cover · rod mounting Ø 12 mm · for type O5 · Housing materials: stainless steel 316Ti / 1.4571 / clamp: diecast zinc	E21210
	Mounting set · Clamp mounting · rod mounting Ø 12 mm · for type O5, O5D · Housing materials: stainless steel 316Ti / 1.4571 / clamp: diecast zinc	E21211
	Mounting set · Clamp mounting · rod mounting Ø 12 mm · for type O5, O5D · Housing materials: stainless steel 316Ti / 1.4571 / clamp: high-grade stainless steel	E21212
	Mounting set · Clamp mounting · With protective cover · rod mounting Ø 14 mm · for type O5 · Housing materials: fixture: stainless steel 316Ti / 1.4571 / clamp: stainless steel	E21142
	Mounting set · Clamp mounting · With protective cover · Free-standing M10 · for type O5 · Housing materials: stainless steel 316Ti / 1.4571 / clamp: diecast zinc	E21084
	Mounting set · Clamp mounting · Free-standing M10 · for type O5 · Housing materials: stainless steel 316Ti / 1.4571 / clamp: diecast zinc	E21083
	Memory plug · Parameter memory for IO-Link sensors · Storage capacity: 2 Kbytes · Housing materials: PA PACM 12 / PET / sealing: FPM / nut: stainless steel 316L / 1.4404 / connector: TPU	E30398

Accessories O4 housing

Type	Description	Order no.
	Angle bracket · O1D, O4 · for type O1D, O4 · Housing materials: stainless steel 316L / 1.4404	E21120
	Angle bracket · O4 · for type O4 · Housing materials: stainless steel 316L / 1.4404	E21117
	Angle bracket · O5, O4 · for mounting O5, O4 sensors instead of OL sensors · Dovetail clamp · Housing materials: Dovetail clamp: AlMgSi0.5 / fixture: AlMg3	E21122
	Dovetail clamp · for type DTS, O4, O5 · Housing materials: AlMgSi0.5	E21088
	Mounting set · Clamp mounting · With protective cover · rod mounting Ø 12 mm · for type O4 · Housing materials: stainless steel 316L / 1.4404 / clamp: diecast zinc	E21215









Position sensors

Type	Description	Order no.
	Mounting set · Clamp mounting · With protective cover · rod mounting Ø 12 mm · for type O4 · Housing materials: stainless steel 316L / 1.4404 / clamp: high-grade stainless steel	E21216
	Mounting set · Clamp mounting · rod mounting Ø 12 mm · for type O4 · Housing materials: stainless steel 316L / 1.4404 / clamp: diecast zinc	E21217
	Mounting set · Clamp mounting · rod mounting Ø 12 mm · for type O4 · Housing materials: stainless steel 316L / 1.4404 / clamp: high-grade stainless steel	E21218
	Mounting set · O4 · Clamp mounting · for type O4 · Housing materials: stainless steel 316L / 1.4404 / clamp: diecast zinc	E21118
	Mounting set · O4 · Clamp mounting · With protective cover · for type O4 · Housing materials: stainless steel 316L / 1.4404 / clamp: diecast zinc	E21119
	Mounting set · O4 · Clamp mounting · for type O4 · Housing materials: stainless steel 316L / 1.4404 / clamp: diecast zinc	E21118

Accessories for system components

Type	Description	Order no.
	clamp · Ø 10 mm; M8 · free-standing M8 · Housing materials: clamp: diecast zinc	E20843
	clamp · Ø 10 mm; M8 · free-standing M8 · Housing materials: clamp: stainless steel 316Ti / 1.4571	E20844
	clamp · Ø 12 mm; M10 · Free-standing M10 · Housing materials: clamp: diecast zinc	E20716
	clamp · Ø 12 mm · rod mounting Ø 12 mm · Housing materials: clamp: diecast zinc	E20717
	clamp · Ø 12 mm · rod mounting Ø 12 mm · Housing materials: clamp: stainless steel	E21110
	clamp · Ø 14 mm; M12 · free-standing M12 · Housing materials: clamp: diecast zinc	E20796
	mounting rod · Ø 10 / M8 · Length: 150 mm · straight · Housing materials: stainless steel 316Ti / 1.4571	E21081

Type	Description	Order no.
	mounting rod · Ø 10 / M8 · Length: 200 mm · angled · Housing materials: stainless steel 316Ti / 1.4571	E80310
	mounting rod · Ø 12 / M10 · Length: 130 mm · straight · Housing materials: stainless steel 316Ti / 1.4571	E20938
	mounting rod · Ø 12 / M10 · Length: 200 mm · angled · Housing materials: stainless steel 316Ti / 1.4571	E20940
	Head cap screw · M8 x 40 mm · ISO 4762 (DIN 912) · free-standing M8 · Housing materials: screw: steel galvanised	E21204
	Head cap screw · M10 x 45 mm · ISO 4762 (DIN 912) · Free-standing M10 · Housing materials: screw: steel galvanised	E21208
	Head cap screw · M10 x 45 mm · ISO 4762 (DIN 912) · Free-standing M10 · Housing materials: screw: high-grade stainless steel	E21209
	Head cap screw · M10 x 120 mm · ISO 4762 (DIN 912) · Free-standing M10 · Housing materials: screw: steel galvanised	E21213
	Head cap screw · M10 x 120 mm · ISO 4762 (DIN 912) · Free-standing M10 · Housing materials: screw: high-grade stainless steel	E21214
	Cube · M8 · aluminium profile · Housing materials: diecast zinc	E20950
	Cube · M10 · aluminium profile · Housing materials: diecast zinc	E20951
	Protective bracket for free-standing and rod mounting · Ø 18 mm · Clamp mounting · Housing materials: stainless steel 316L / 1.4404	E21125
	Protective bracket for free-standing and rod mounting · Ø 18 mm · with end stop · Mounting clamp · Clamp mounting · Housing materials: Mounting clamp: PC black / Angle bracket: stainless steel 316L / 1.4404	E21126

Wiring diagrams

Core colours

BN brown
BU blue
BK black

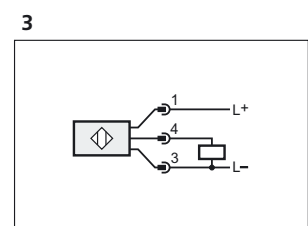
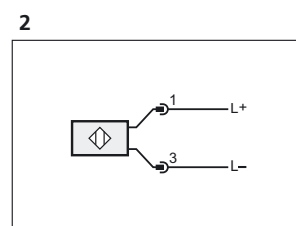
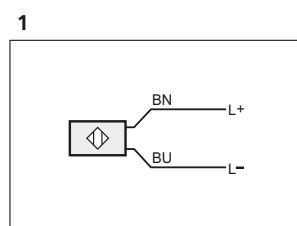



Position sensors

Wiring diagrams

4

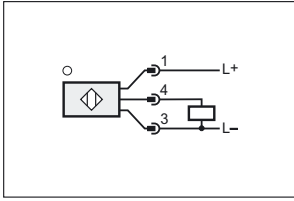

11

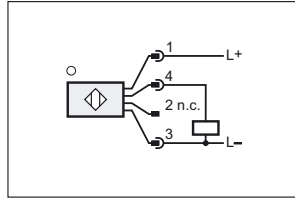

18

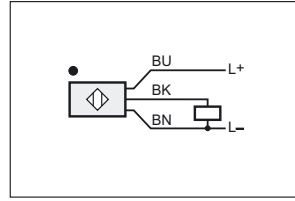

25

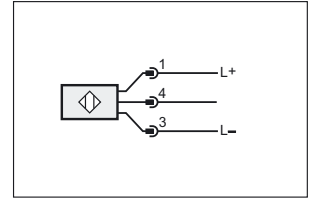

5

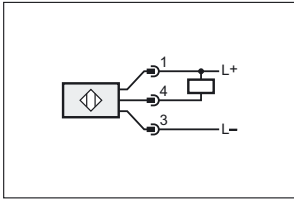

12

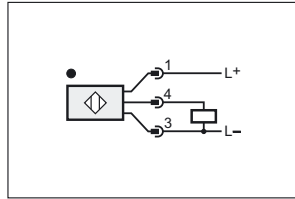

19

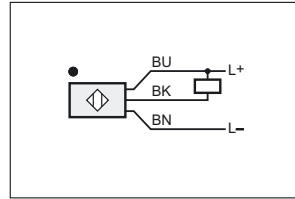

26

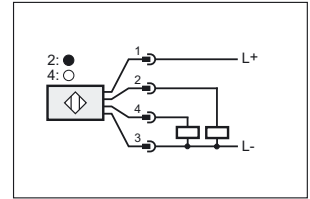

6

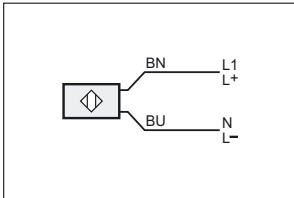

13

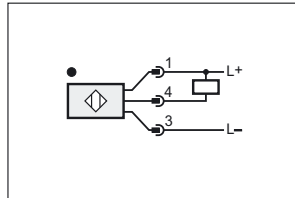

20

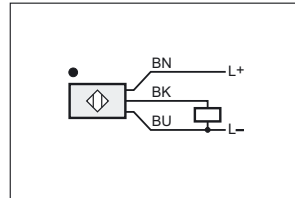

27

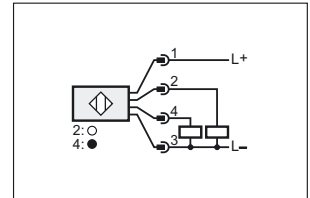

7

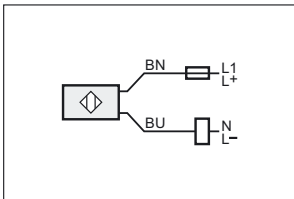

14

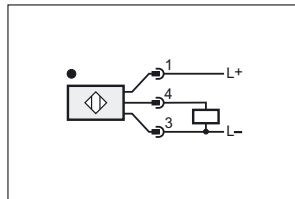

21

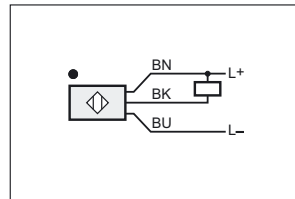

28

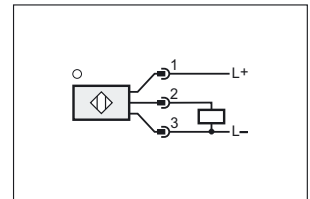

8

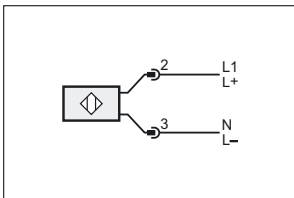

15

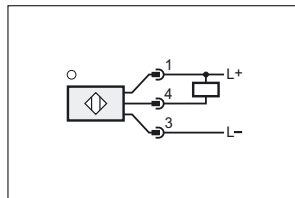

22

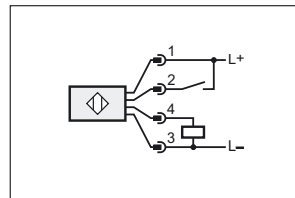

29

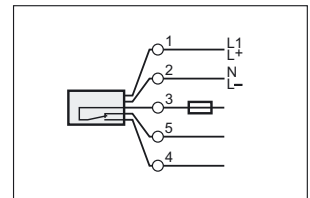

9

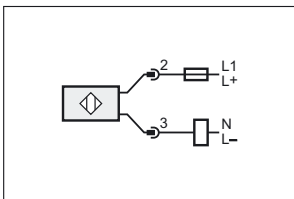

16

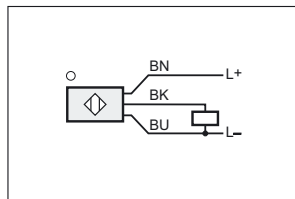

23

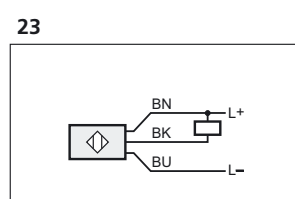

30

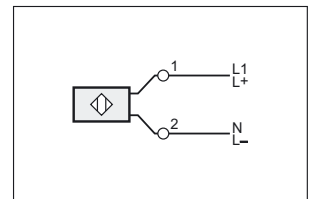

10

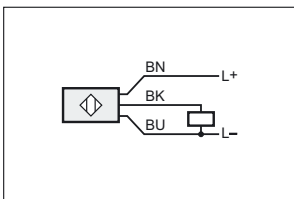

17

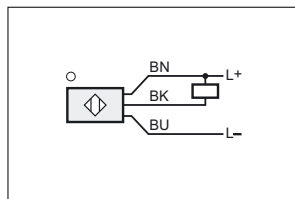

24

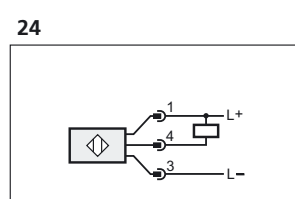

2: Teach

Wiring diagrams

31

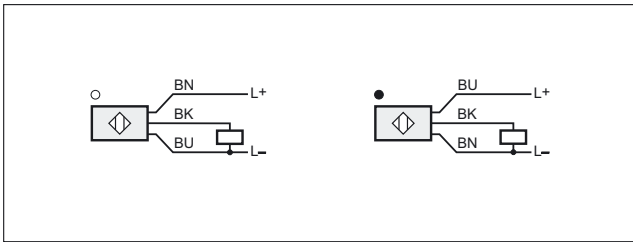

32

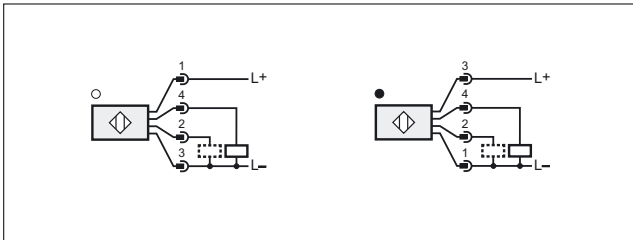

2: function check

33

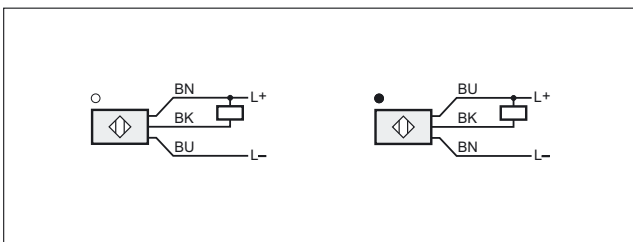

34

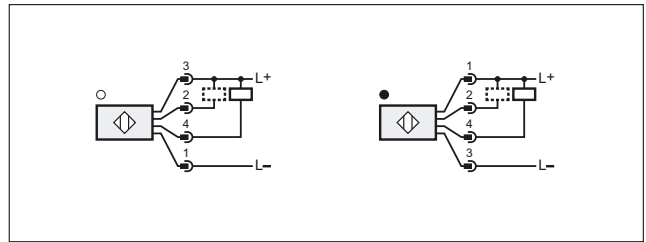

2: function check

35

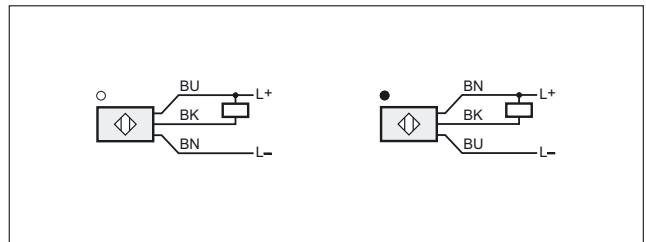

36

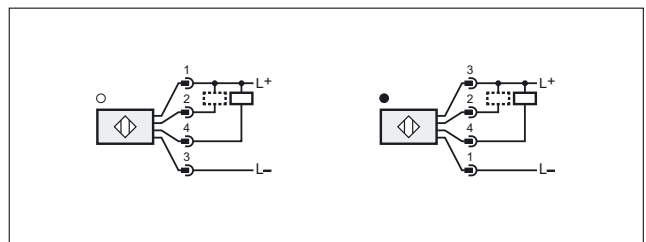

2: function check

Scale drawings / drawing no. – CAD download: www.ifm.com

1

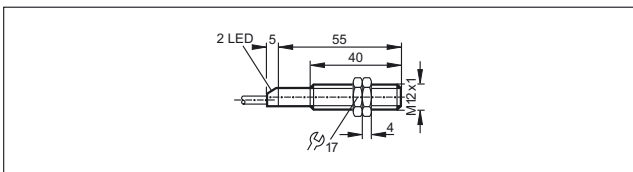

2

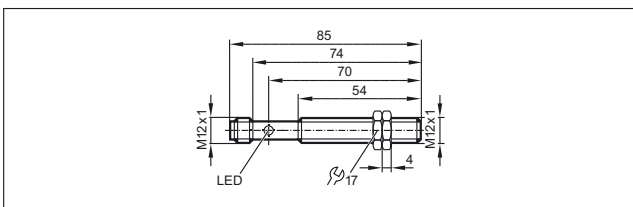

3

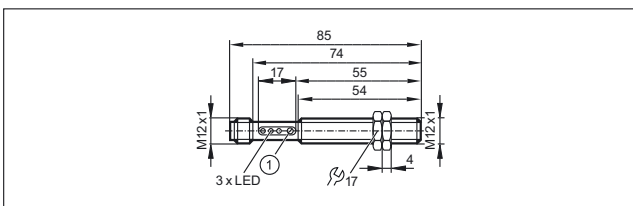

1: potentiometer

4

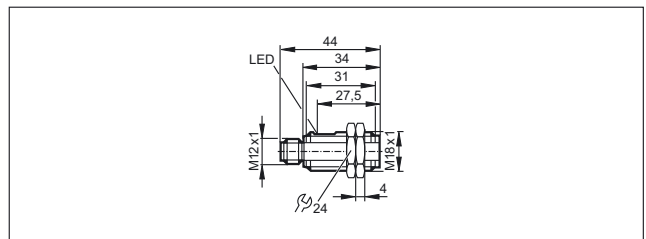

5

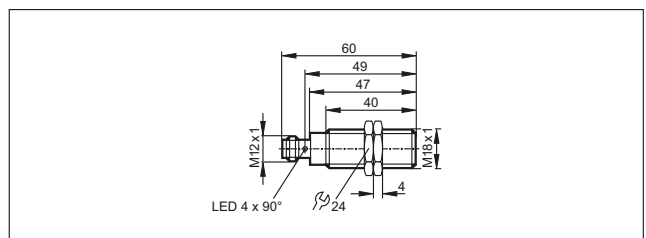



Position sensors

Scale drawings / drawing no. – CAD download: www.ifm.com

6

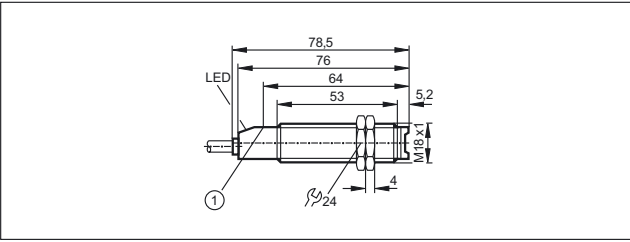

1: pushbutton

7

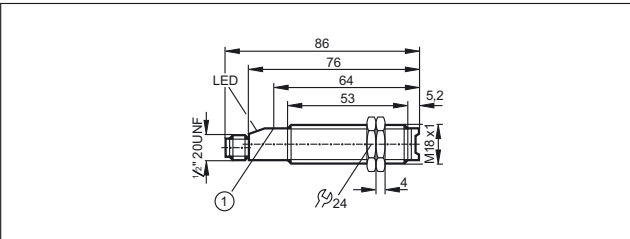

1: pushbutton

8

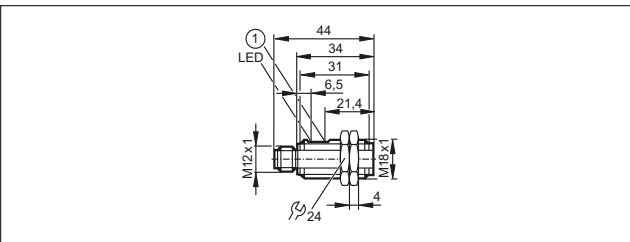

1: potentiometer

9

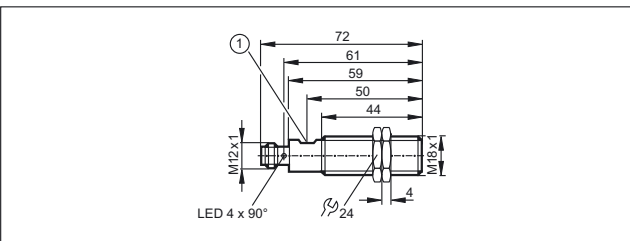

1: potentiometer

10

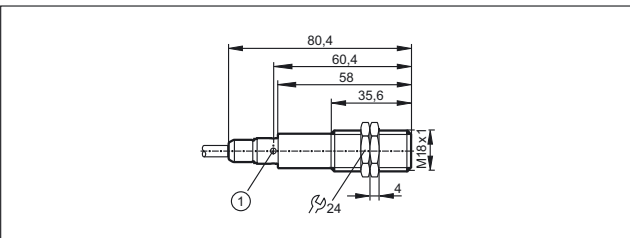

1: LED 4 x 90°

11

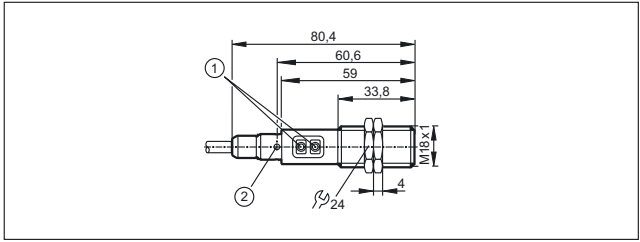

1: Programming buttons, 2: LED 4 x 90°

12

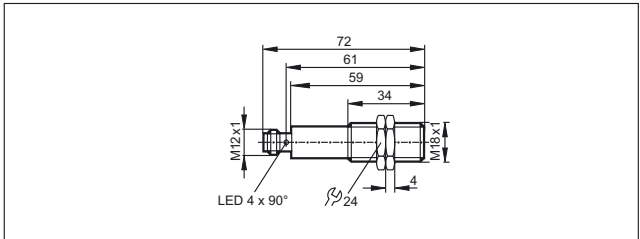

13

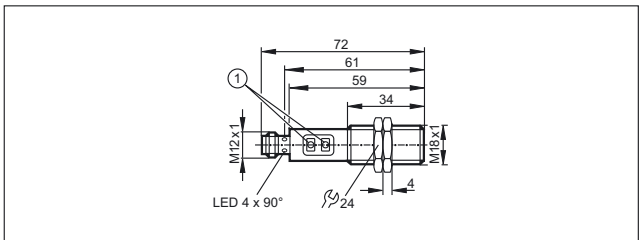

1: Programming buttons

14

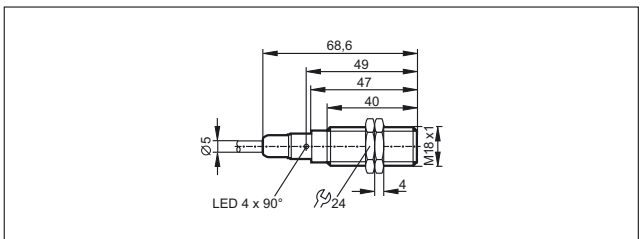

15

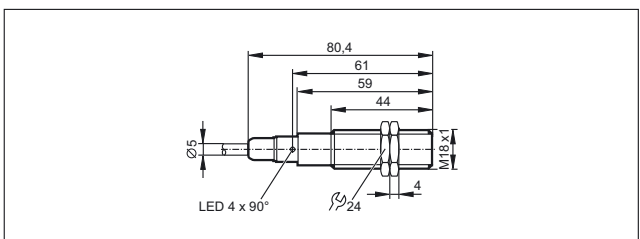

16

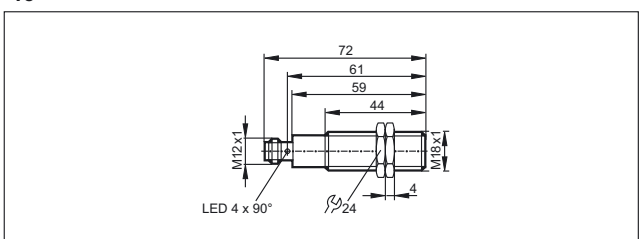

Scale drawings / drawing no. – CAD download: www.ifm.com

17

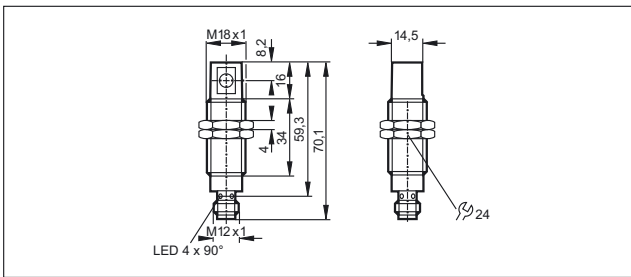

18

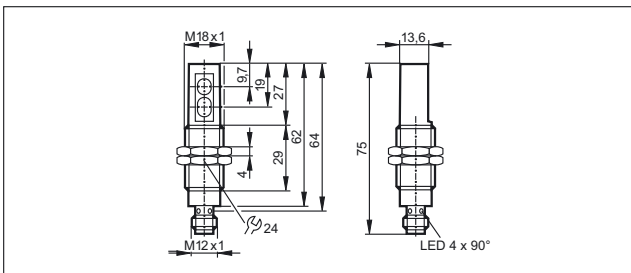

19

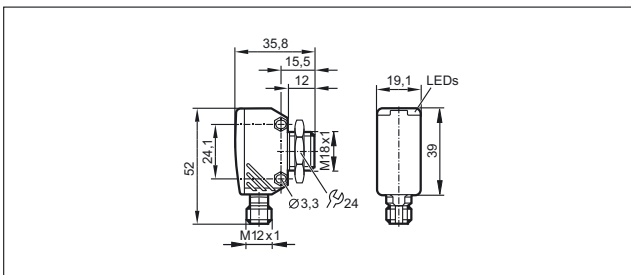

20

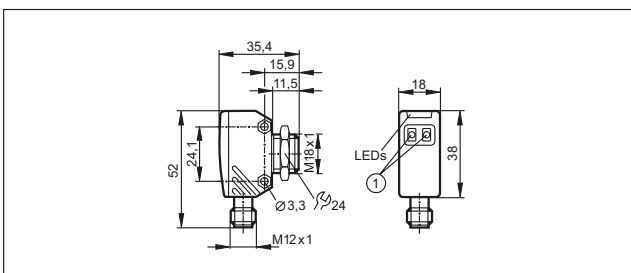

1: setting pushbuttons

21

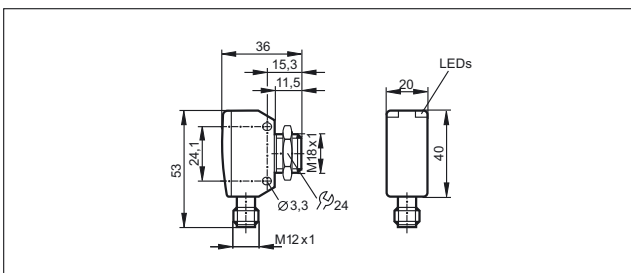

22

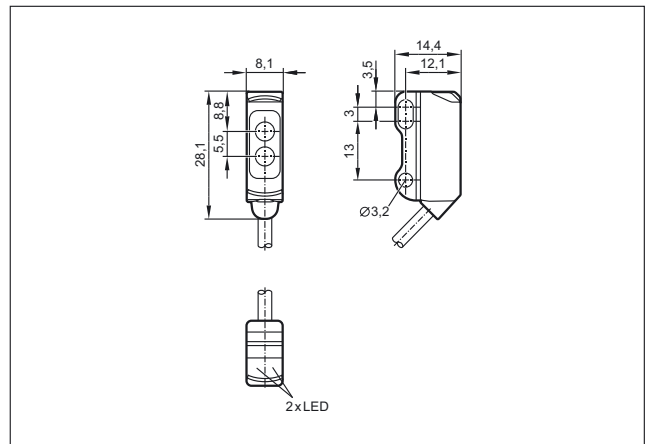

23

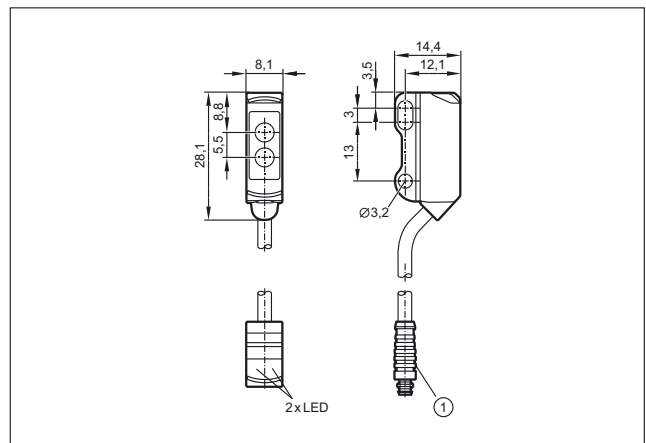

1: illustration (example)

24

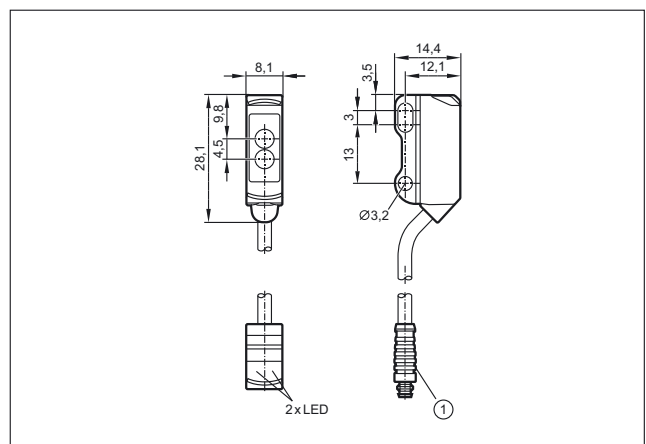

1: illustration (example)



Position sensors

Scale drawings / drawing no. – CAD download: www.ifm.com

25

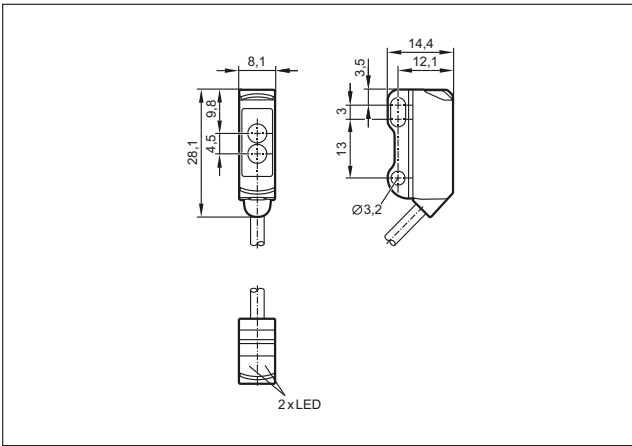

28

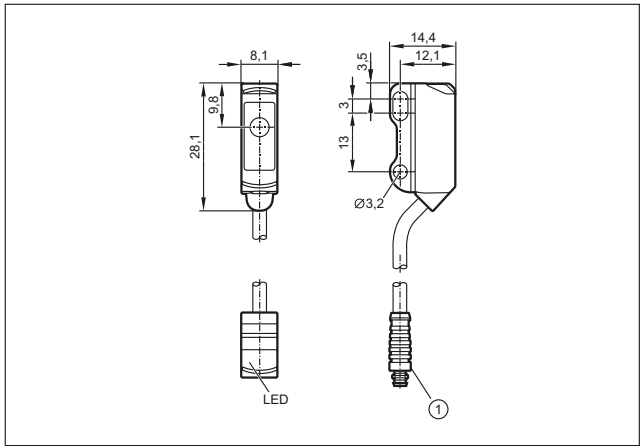

1: illustration (example)

26

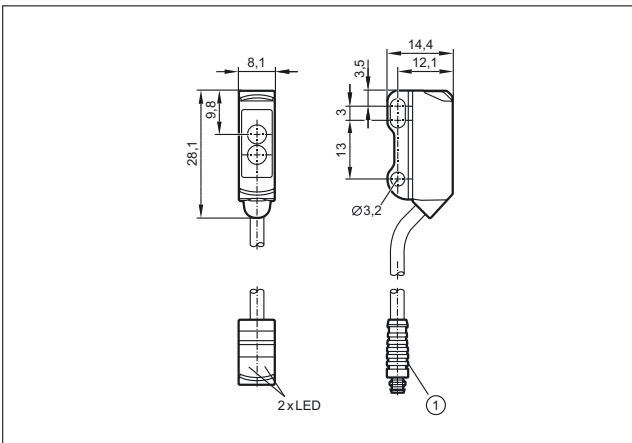

1: illustration (example)

29

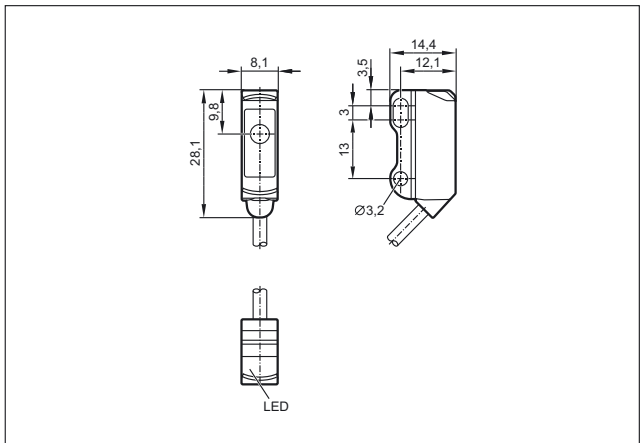

27

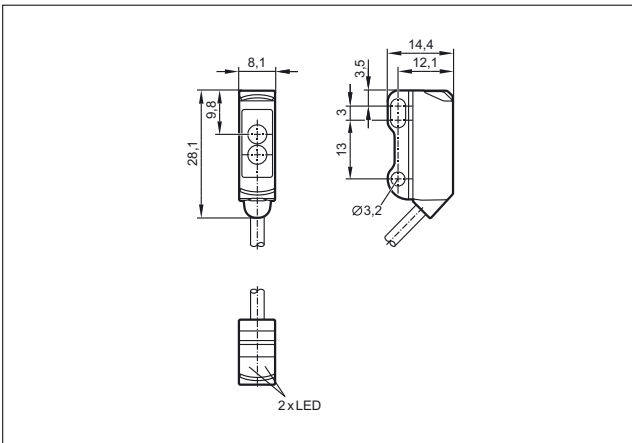

30

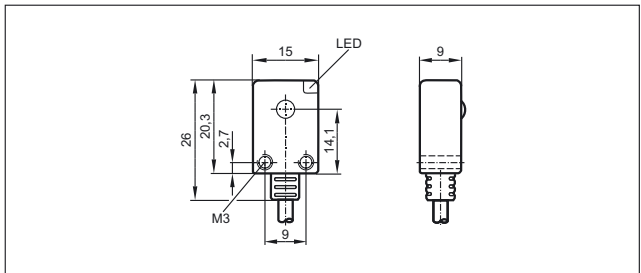

31

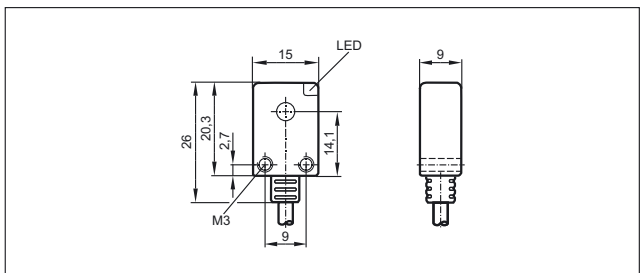

Scale drawings / drawing no. – CAD download: www.ifm.com

32

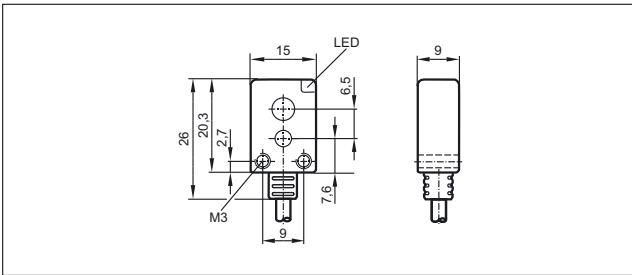

33

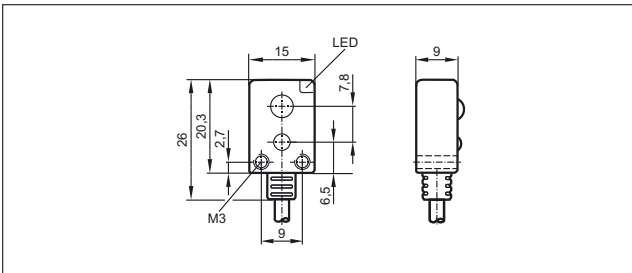

34

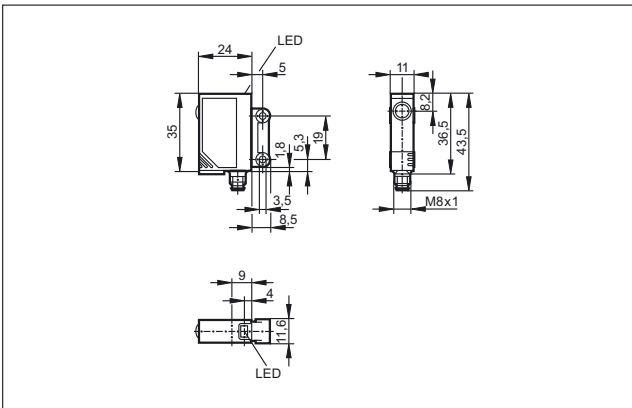

35

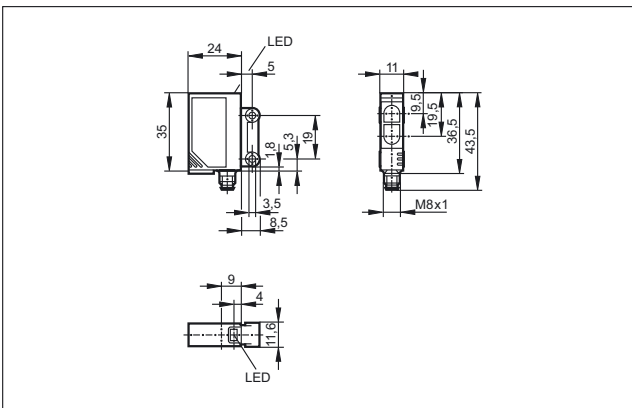

36

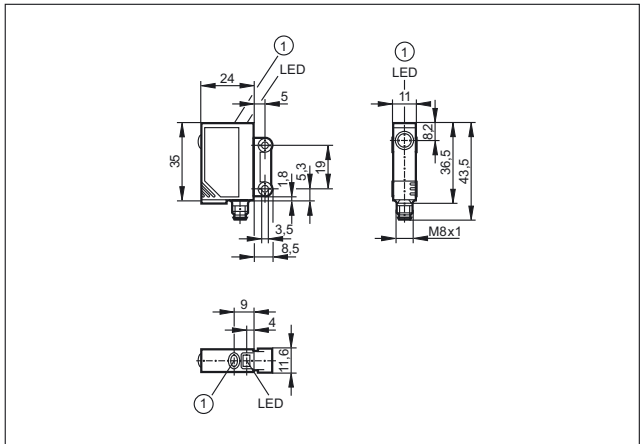

1: pushbutton

37

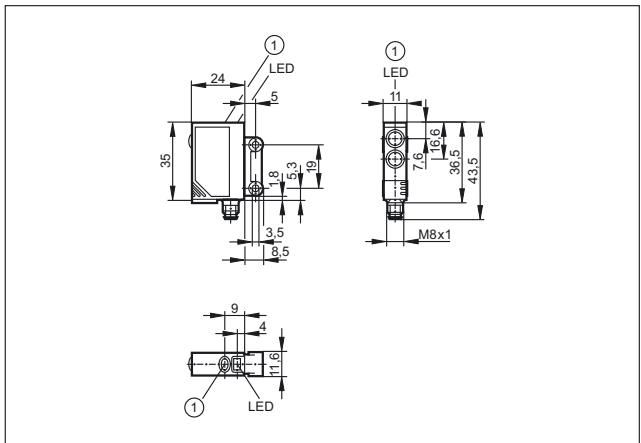

1: pushbutton

38

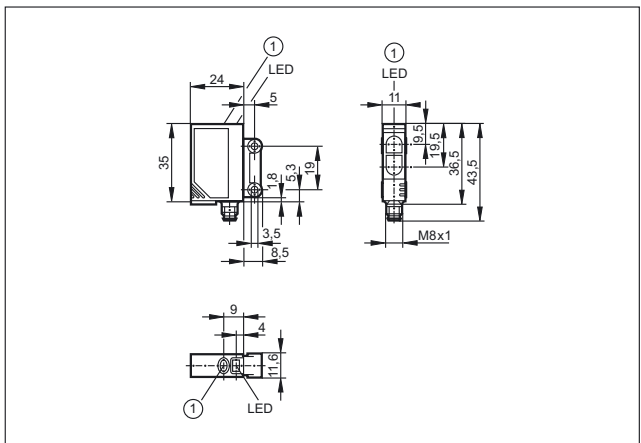

1: pushbutton



Position sensors

Scale drawings / drawing no. – CAD download: www.ifm.com

39

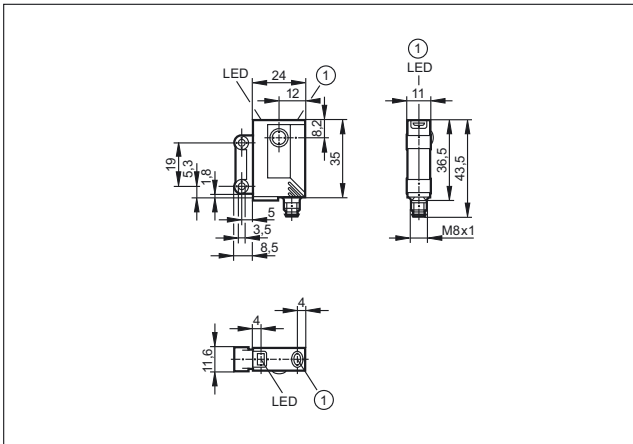

1: pushbutton

40

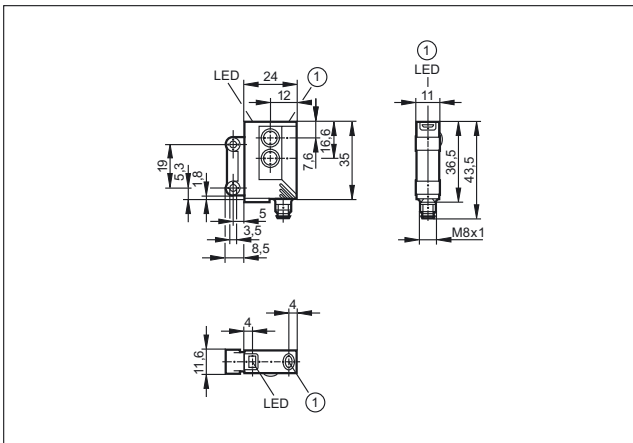

1: pushbutton

41

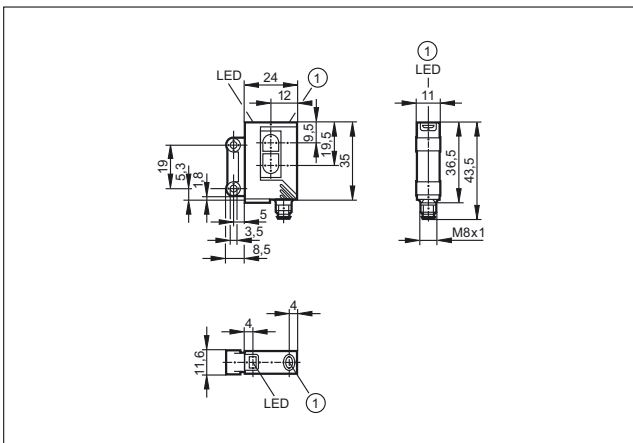

1: pushbutton

42

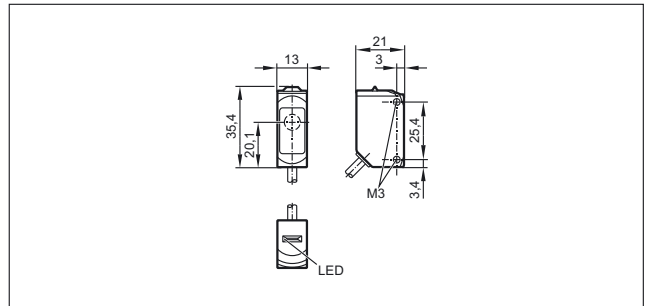

43

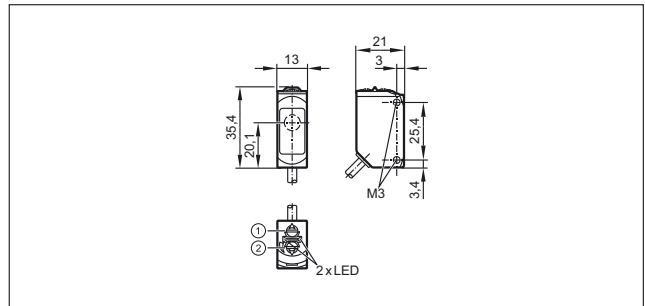

44

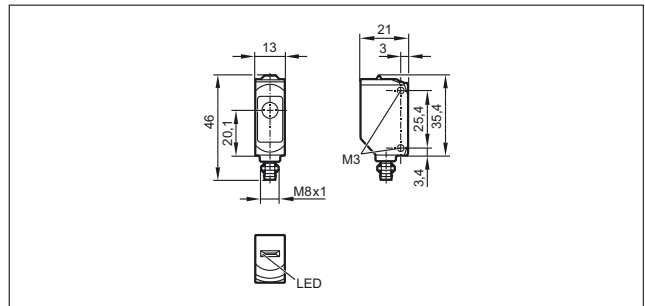

45

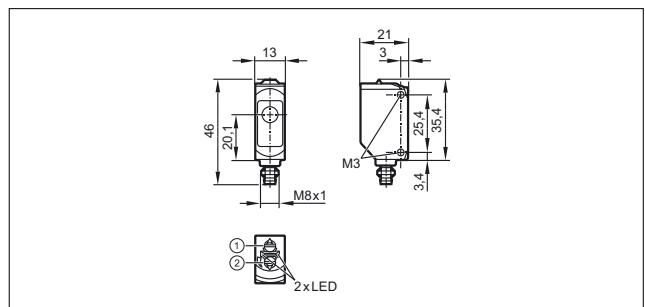

46

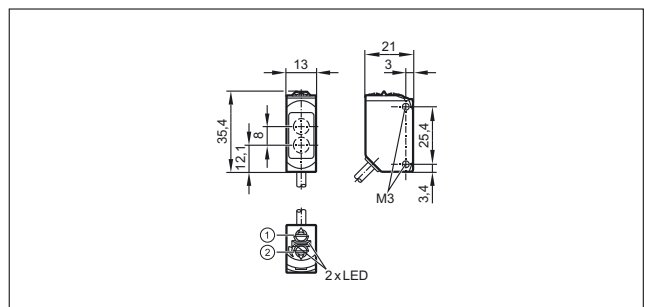

Scale drawings / drawing no. – CAD download: www.ifm.com

47

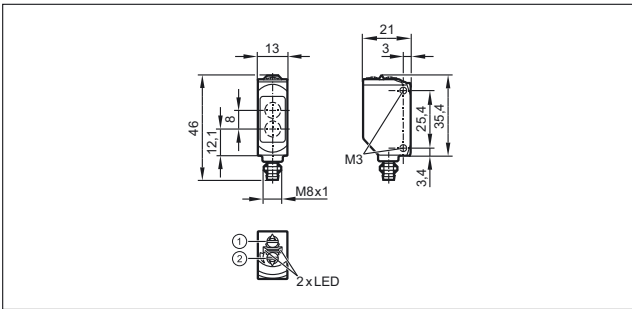

52

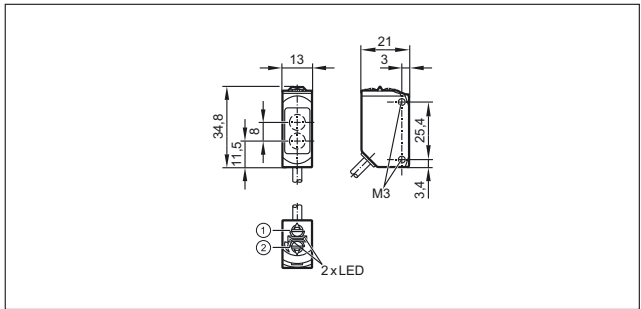

48

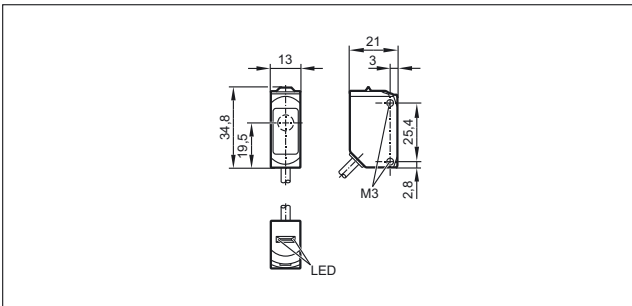

53

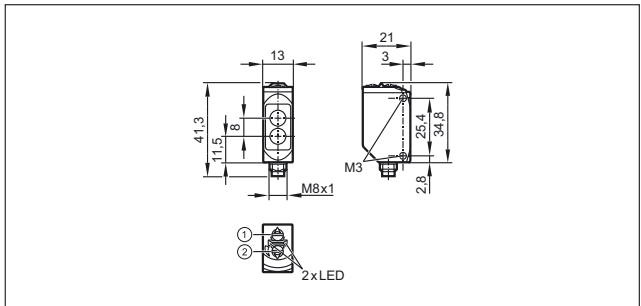

49

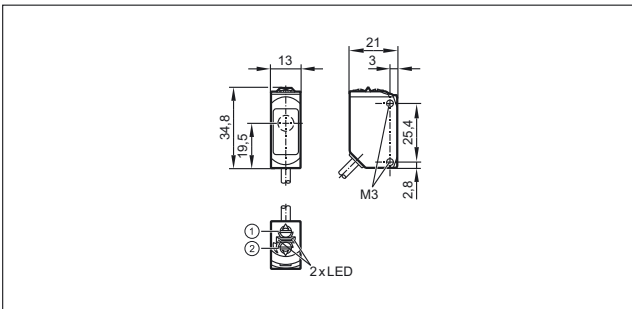

54

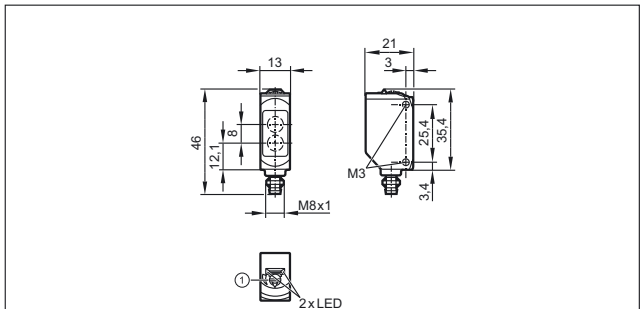

1:: output function switch, 2:: potentiometer sensitivity

1: potentiometer sensitivity

50

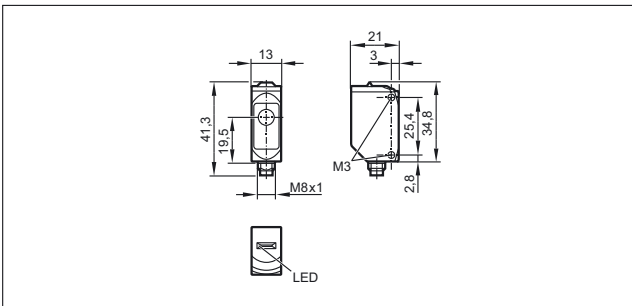

55

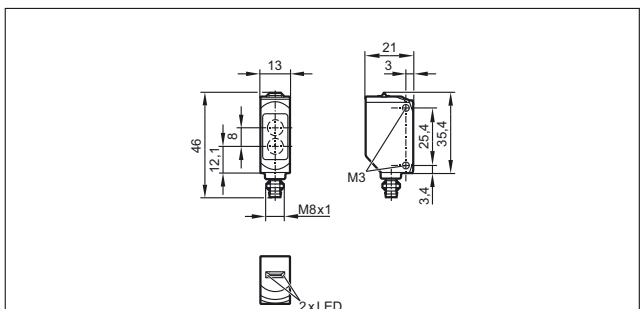

51

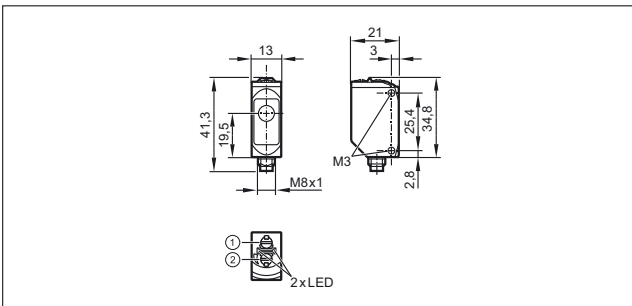

1:: output function switch, 2:: potentiometer sensitivity



Position sensors

Scale drawings / drawing no. – CAD download: www.ifm.com

56

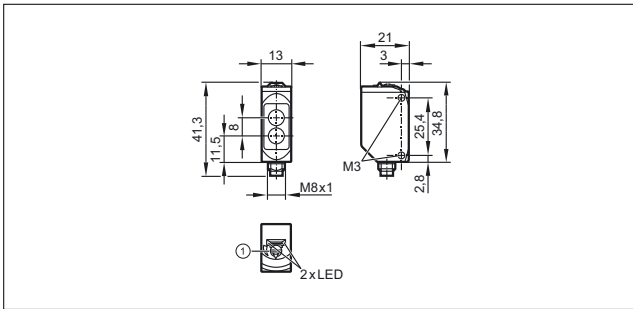

1: potentiometer sensitivity

57

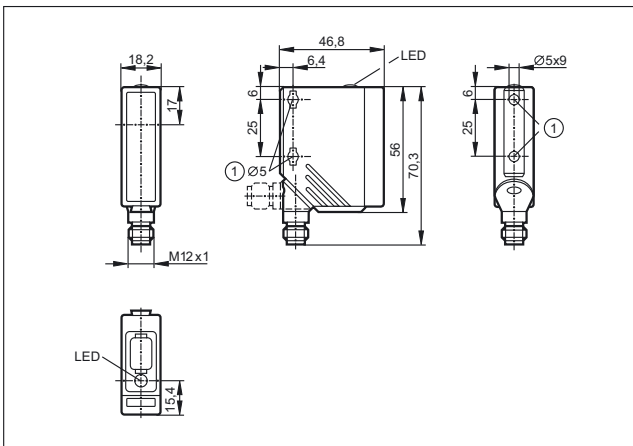

1: When a M5 mounting screw is used, the max. tightening torque is 2 Nm.

58

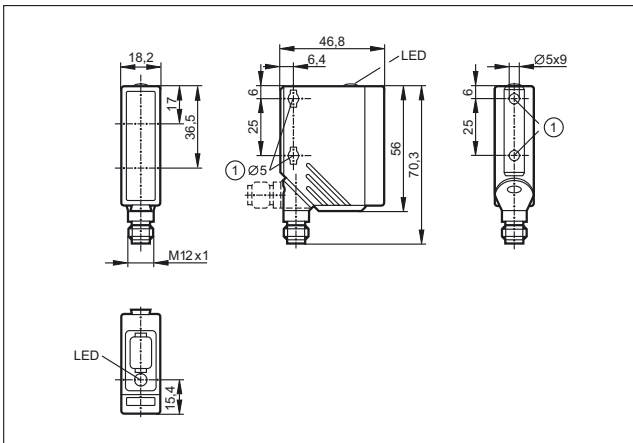

1: When a M5 mounting screw is used, the max. tightening torque is 2 Nm.

59

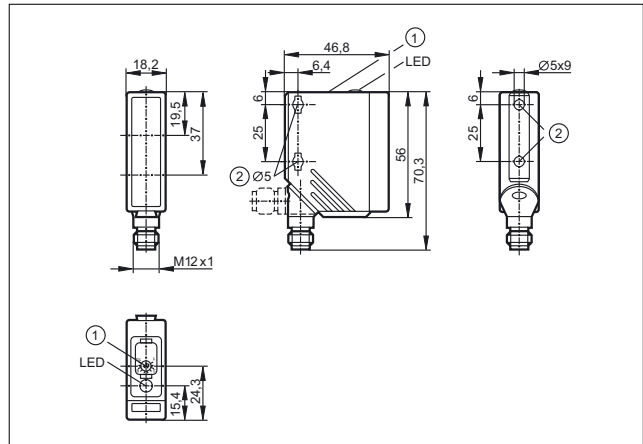

1: potentiometer, 2: When a M5 mounting screw is used, the max. tightening torque is 2 Nm.

60

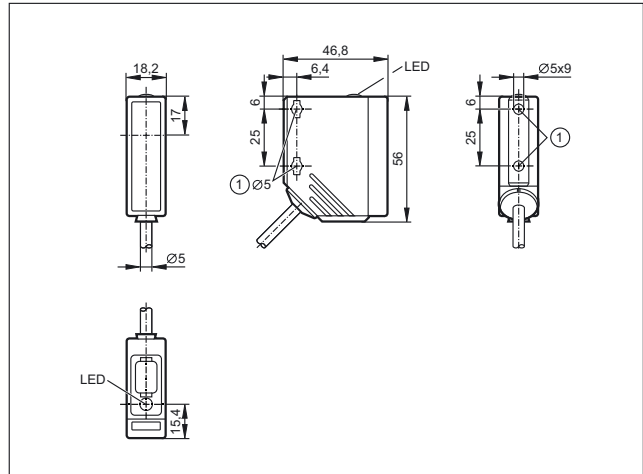

1: When a M5 mounting screw is used, the max. tightening torque is 2 Nm.

61

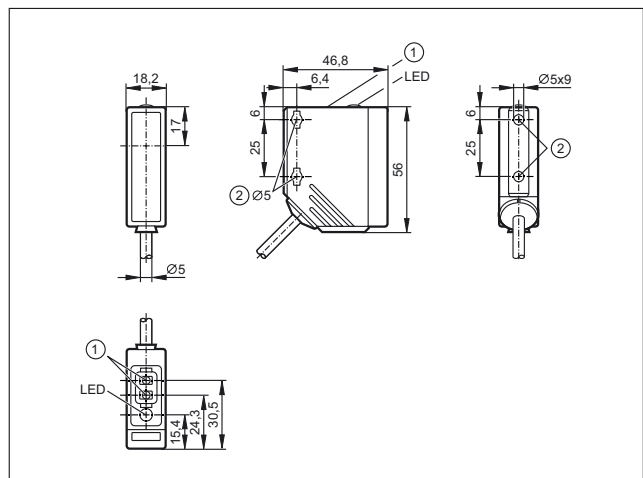

1: Programming buttons, 2: When a M5 mounting screw is used, the max. tightening torque is 2 Nm.

Scale drawings / drawing no. – CAD download: www.ifm.com

62

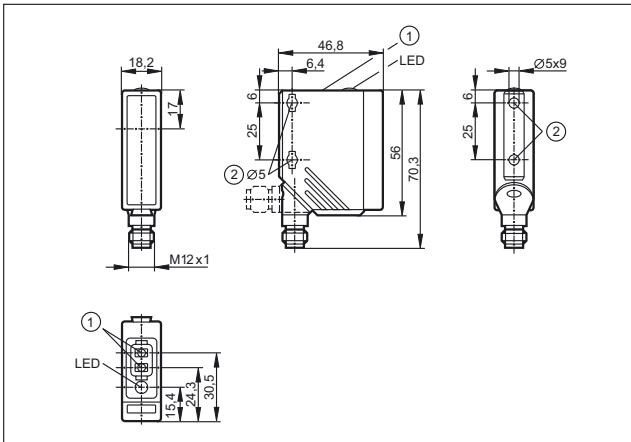

1: Programming buttons, 2: When a M5 mounting screw is used, the max. tightening torque is 2 Nm.

63

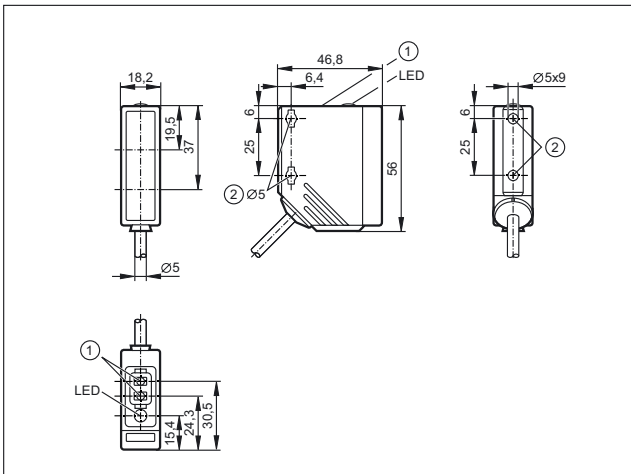

1: Programming buttons, 2: When a M5 mounting screw is used, the max. tightening torque is 2 Nm.

64

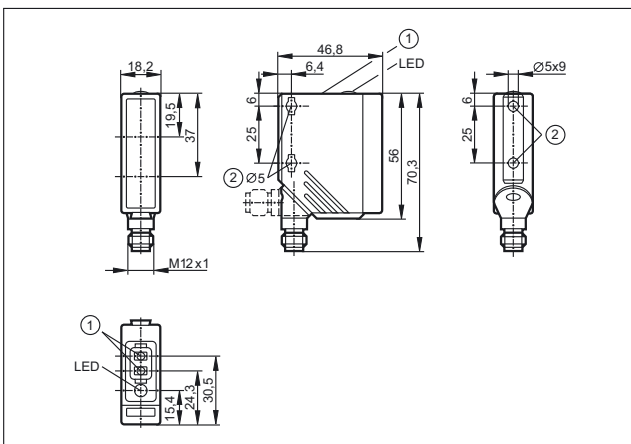

1: Programming buttons, 2: When a M5 mounting screw is used, the max. tightening torque is 2 Nm.

65

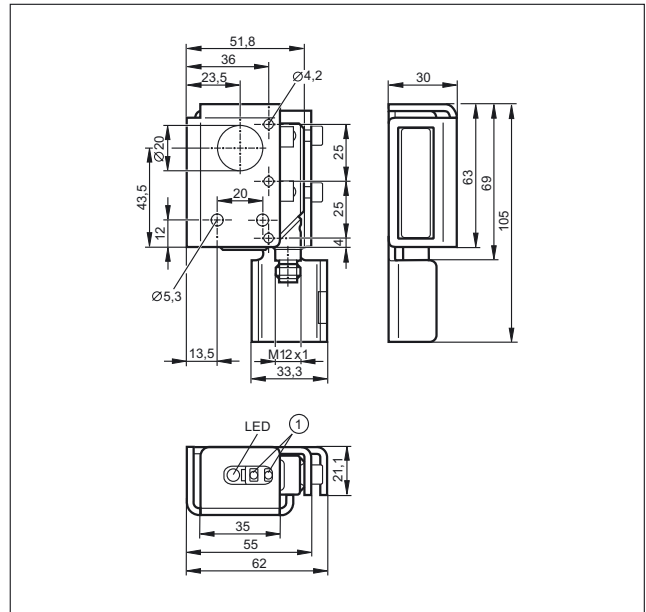

1: Programming buttons

66

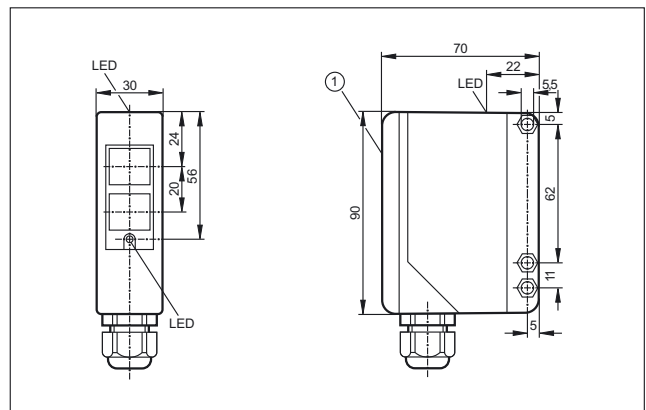

1: selection switch, pot's (under cover)

67

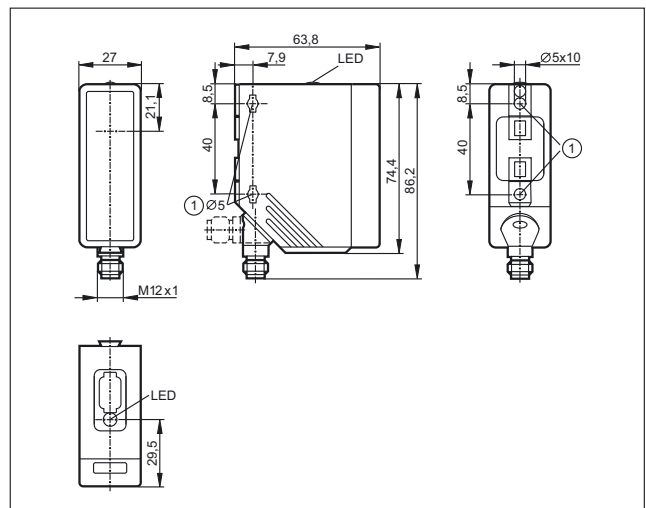

1: When a M5 mounting screw is used, the max. tightening torque is 2 Nm.



Position sensors

Scale drawings / drawing no. – CAD download: www.ifm.com

68

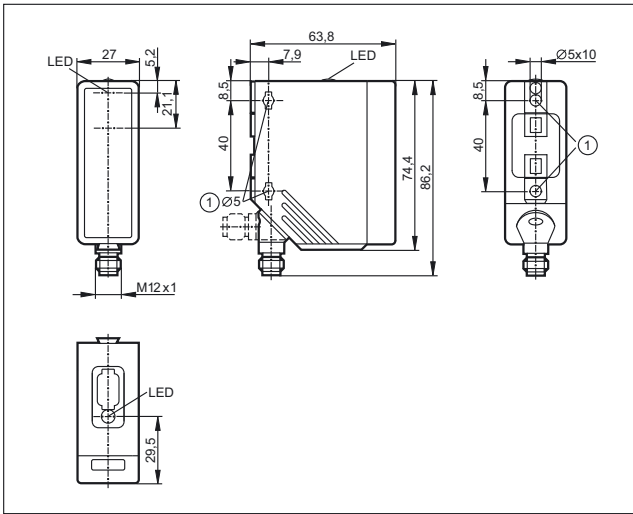

1: When a M5 mounting screw is used, the max. tightening torque is 2 Nm.

71

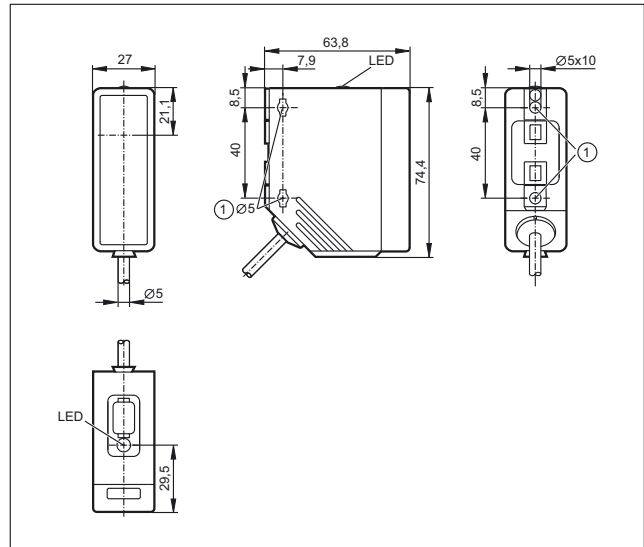

1: When a M5 mounting screw is used, the max. tightening torque is 2 Nm.

69

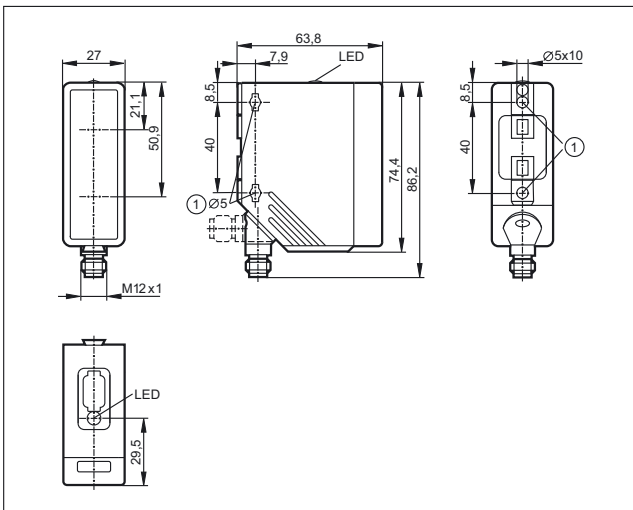

1: When a M5 mounting screw is used, the max. tightening torque is 2 Nm.

72

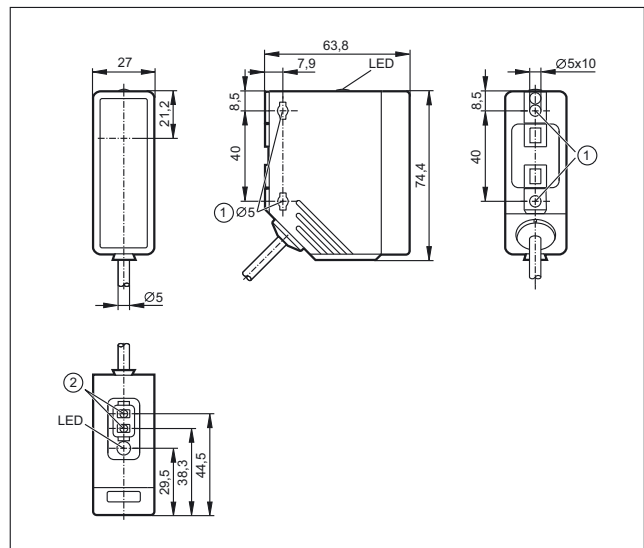

1: When a M5 mounting screw is used, the max. tightening torque is 2 Nm., 2: Programming buttons

70

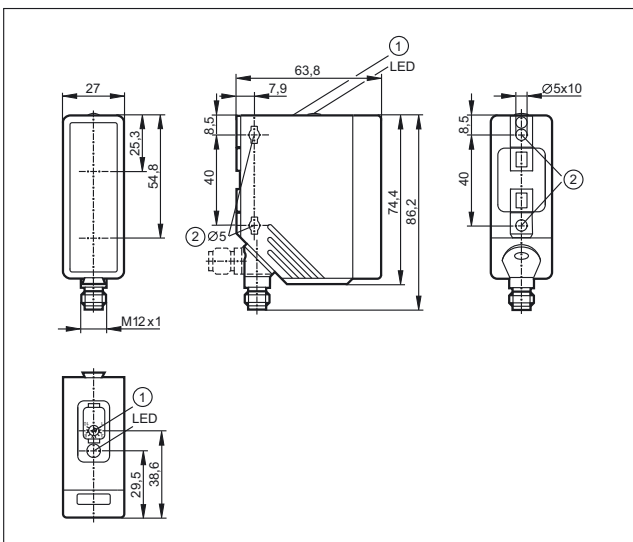

1: potentiometer, 2: When a M5 mounting screw is used, the max. tightening torque is 2 Nm.

Scale drawings / drawing no. – CAD download: www.ifm.com

73

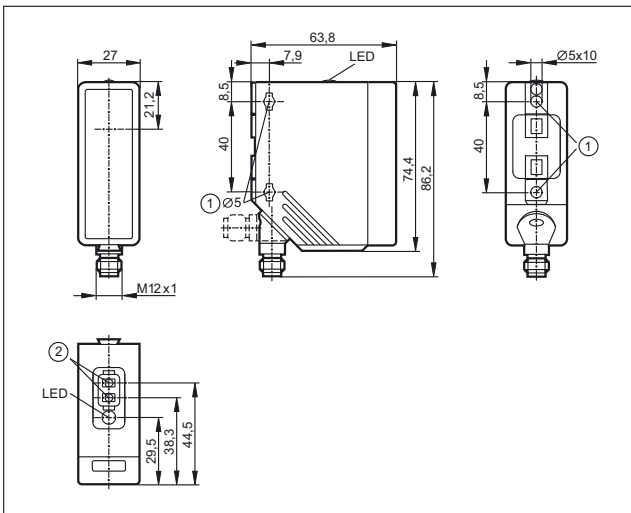

1: When a M5 mounting screw is used, the max. tightening torque is 2 Nm., 2: Programming buttons

75

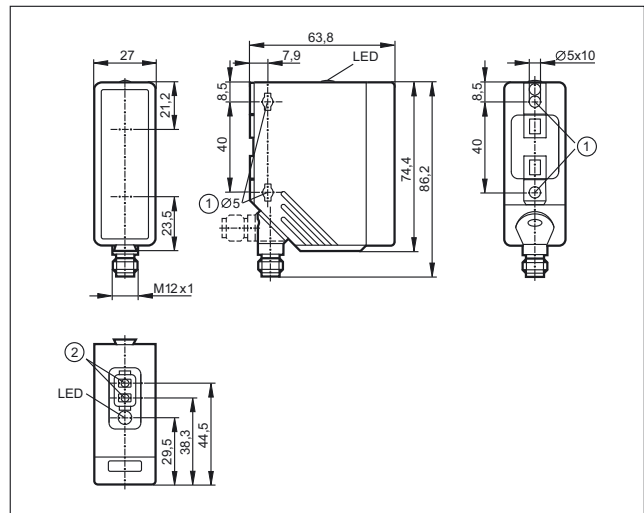

1: When a M5 mounting screw is used, the max. tightening torque is 2 Nm., 2: Programming buttons

74

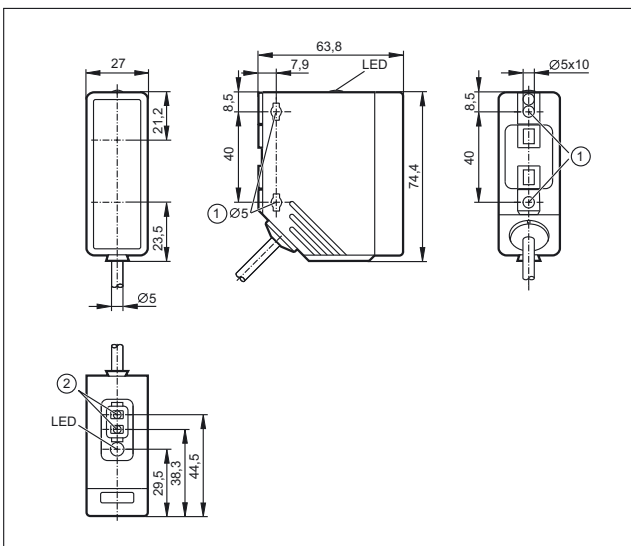

1: When a M5 mounting screw is used, the max. tightening torque is 2 Nm., 2: Programming buttons

76

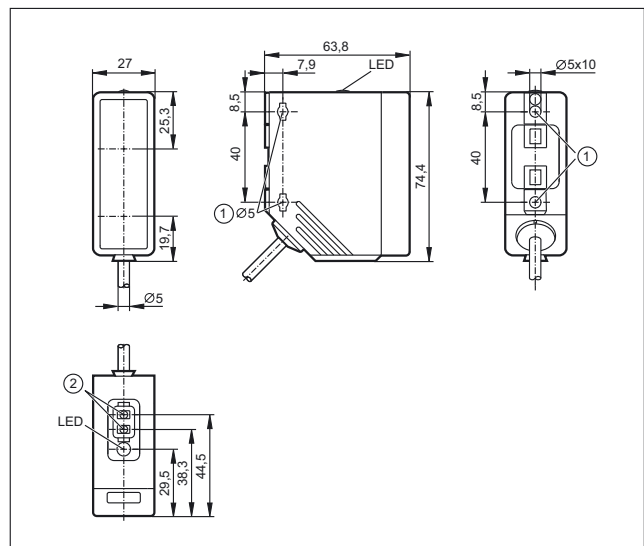

1: When a M5 mounting screw is used, the max. tightening torque is 2 Nm., 2: Programming buttons

77

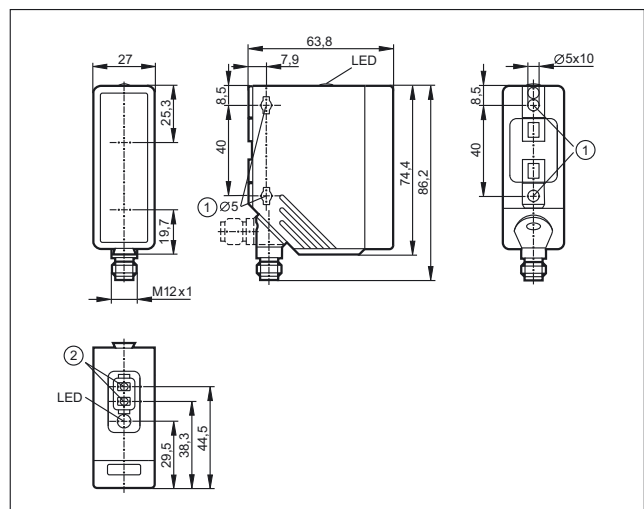

1: When a M5 mounting screw is used, the max. tightening torque is 2 Nm., 2: Programming buttons



Photoelectric fork and angle sensors for tiny objects



Photoelectric fork sensors /
angle sensors



Quick set-up: no need to align transmitter and receiver

Fine and precise light beam across the whole fork width

Metal housing reduces distortion

Light-on / dark-on mode selectable via rotary switch

Easy sensitivity setting via potentiometer

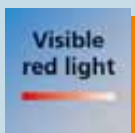

Optical fork and angle sensors

The photoelectric fork and angle sensors are made from distortion-resistant diecast zinc and feature a high switching frequency. Possible applications are in particular part monitoring in feeding technology and handling systems. Further application examples are belt edge and double feed monitoring.

Easy to use

Sensitivity setting using the potentiometer and setting of light-on / dark-on mode using the rotary switch are simple and time-saving. No complex adjustment is required because transmitter and receiver are already aligned towards each other. Due to the fine and precise red light beam which is constant across the entire fork width, out-of-balance monitoring of shafts can also be carried out.

System overview	Page
Optical fork sensors	276
Laser fork sensors, laser class 2	277
Optical angle sensors	277
Wiring diagrams	277 - 278
Scale drawings / drawing no. – CAD download: www.ifm.com	278 - 279



Position sensors

Optical fork sensors

Type	Fork width (w) [mm]	Fork depth (d) [mm]	Smallest detectable object Ø [mm]	Switching frequency [Hz]	Output H = light-on D = dark-on	U _b [V]	Drawing no.	Order no.
------	------------------------	------------------------	--------------------------------------	-----------------------------	---------------------------------------	-----------------------	-------------	-----------

Optical fork sensor · Type OPU · M8 connector · metal · DC · Wiring diagram no. 3 · Connector groups 1, 2, 3, 78, 84, 145, 146

	10	17	0.3	10000	H/D PNP/NPN	10...35	1	OPU200
---	----	----	-----	-------	-------------	---------	---	---------------

Optical fork sensor · Type OPU · M8 connector · metal · DC · Wiring diagram no. 1 · Connector groups 1, 2, 3, 78, 84, 145, 146

	20	25	0.4	4000	H/D PNP	10...35	2	OPU201
---	----	----	-----	------	---------	---------	---	---------------

	30	35	0.5	4000	H/D PNP	10...35	3	OPU202
---	----	----	-----	------	---------	---------	---	---------------

	50	55	0.5	4000	H/D PNP	10...35	4	OPU203
---	----	----	-----	------	---------	---------	---	---------------

	80	55	0.5	4000	H/D PNP	10...35	5	OPU204
---	----	----	-----	------	---------	---------	---	---------------

	120	60	0.8	2000	H/D PNP	10...35	6	OPU205
---	-----	----	-----	------	---------	---------	---	---------------

Optical fork sensor · Type OPU · M8 connector · metal · DC · Wiring diagram no. 2 · Connector groups 1, 3, 78, 84, 145

	20	25	0.4	4000	H/D NPN	10...35	2	OPU207
---	----	----	-----	------	---------	---------	---	---------------

	30	35	0.5	4000	H/D NPN	10...35	3	OPU208
---	----	----	-----	------	---------	---------	---	---------------

	50	55	0.5	4000	H/D NPN	10...35	4	OPU209
---	----	----	-----	------	---------	---------	---	---------------

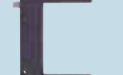

	80	55	0.5	4000	H/D NPN	10...35	5	OPU210
---	----	----	-----	------	---------	---------	---	---------------

	120	60	0.8	2000	H/D NPN	10...35	6	OPU211
---	-----	----	-----	------	---------	---------	---	---------------

Laser fork sensors, laser class 2

Type	Fork width (w) [mm]	Fork depth (d) [mm]	Smallest detectable object Ø [mm]	Switching frequency [Hz]	Output H = light-on D = dark-on	U _b [V]	Drawing no.	Order no.
------	------------------------	------------------------	--------------------------------------	-----------------------------	---------------------------------------	-----------------------	-------------	-----------



Optical fork sensor · Type OPU · M8 connector · metal · DC · Wiring diagram no. 1 · Connector groups 1, 2, 3, 78, 84, 145, 146

	30	35	0.05	3000	H/D PNP	10...30	7	OPU700
	50	55	0.05	3000	H/D PNP	10...30	8	OPU701
	80	55	0.05	3000	H/D PNP	10...30	9	OPU702



Optical angle sensors

Type	Side length (x, y) [mm]	Sensor width (z) [mm]	Smallest detectable object Ø [mm]	Switching frequency [Hz]	Output H = light-on D = dark-on	U _b [V]	Drawing no.	Order no.
------	----------------------------	--------------------------	--------------------------------------	-----------------------------	---------------------------------------	-----------------------	-------------	-----------

Optical angle sensor · Type OPL · M8 connector · metal · DC · Wiring diagram no. 1 · Connector groups 1, 2, 3, 78, 84, 145, 146

	50	60	0.5	4000	H/D PNP	10...35	10	OPL200
	80	100	0.7	4000	H/D PNP	10...35	11	OPL201

Optical angle sensor · Type OPL · M8 connector · metal · DC · Wiring diagram no. 2 · Connector groups 1, 3, 78, 84, 145

	50	60	0.5	4000	H/D NPN	10...35	10	OPL202
	80	100	0.7	4000	H/D NPN	10...35	11	OPL203

Wiring diagrams

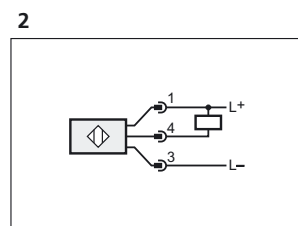
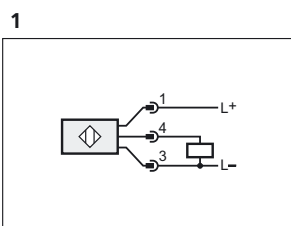



Position sensors

Wiring diagrams

3

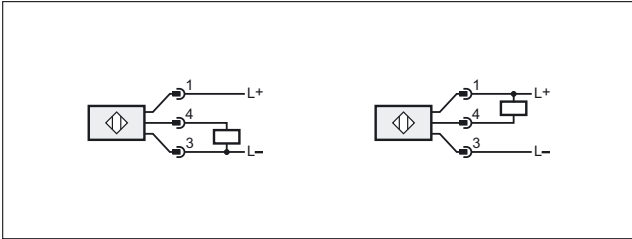

Scale drawings / drawing no. – CAD download: www.ifm.com

1

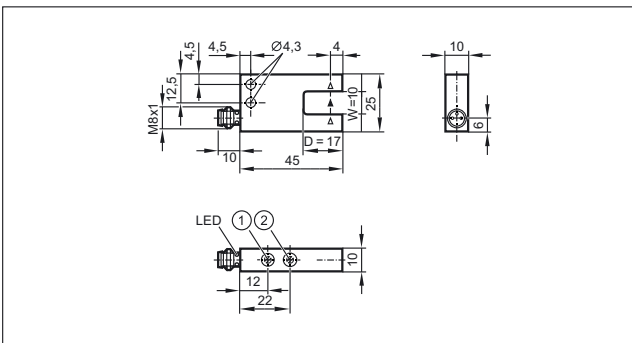

1: output function switch, 2: potentiometer sensitivity

5

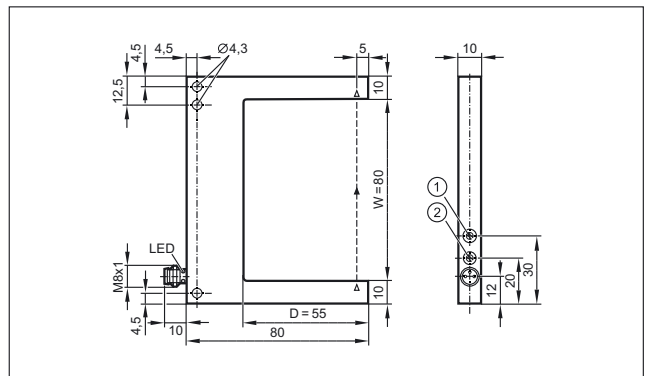

1: potentiometer sensitivity, 2: output function switch

2

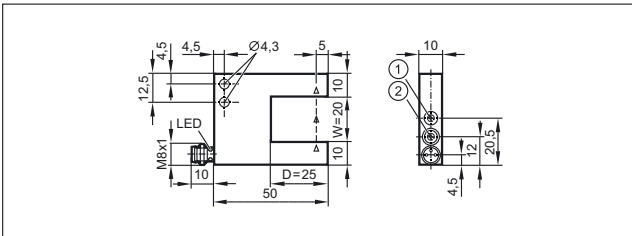

1: potentiometer sensitivity, 2: output function switch

6

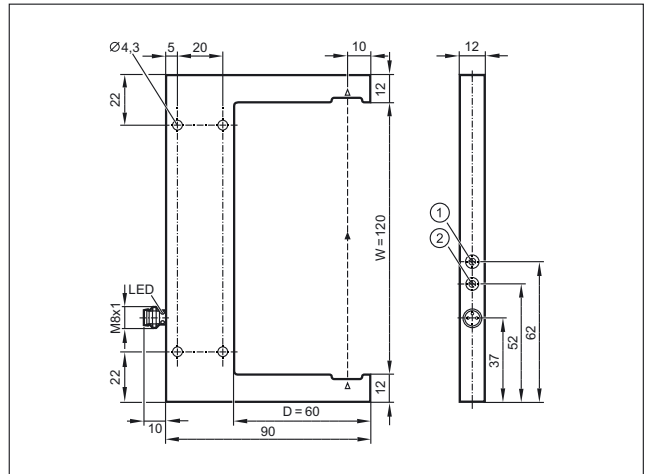

1: potentiometer sensitivity, 2: output function switch

3

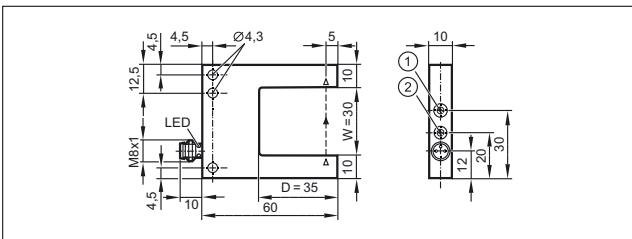

1: potentiometer sensitivity, 2: output function switch

7

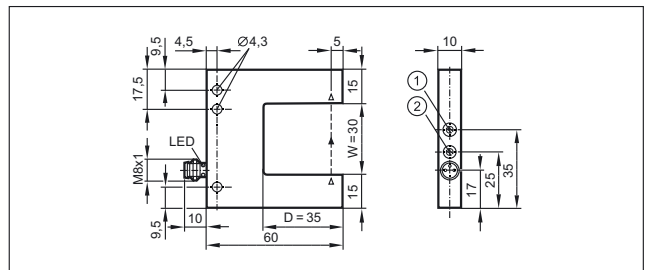

1: potentiometer sensitivity, 2: output function switch

4

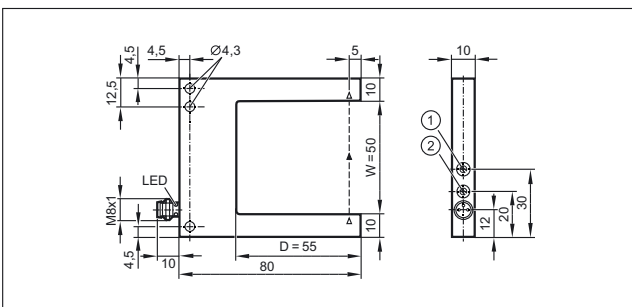

1: potentiometer sensitivity, 2: output function switch

Scale drawings / drawing no. – CAD download: www.ifm.com

8

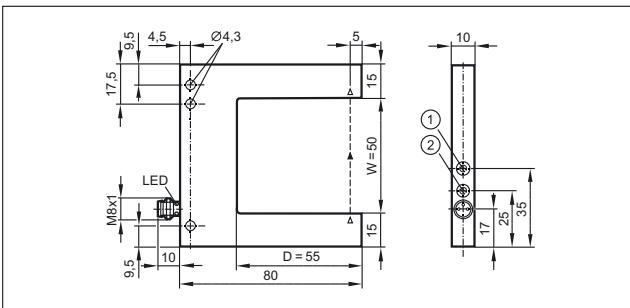

1: potentiometer sensitivity, 2: output function switch

9

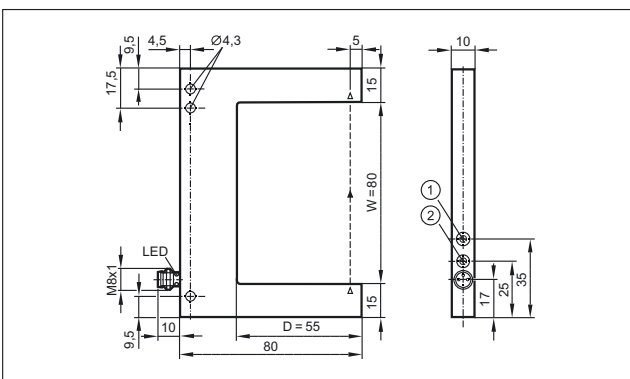

1: potentiometer sensitivity, 2: output function switch

10

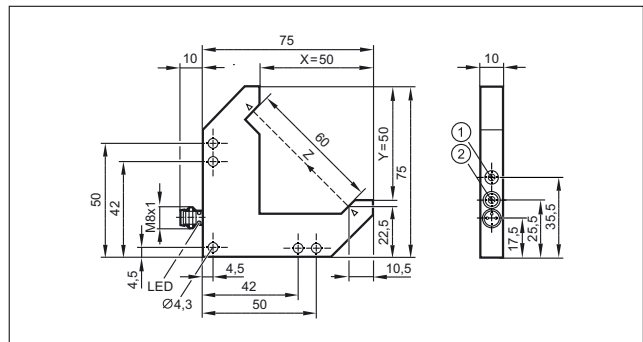

1: potentiometer sensitivity, 2: output function switch

11

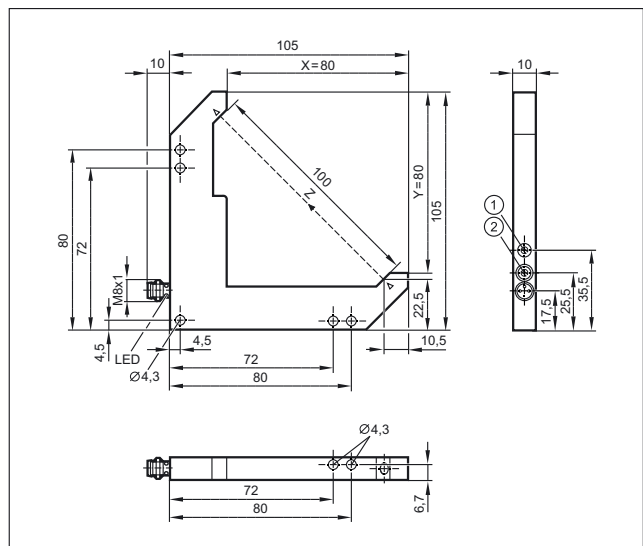

1: potentiometer sensitivity, 2: output function switch



Laser and distance sensors for precise object detection



Laser sensors / distance measurement sensors



Detection of tiny objects

Clearly visible red light for easy adjustment to the object.

Automatic switch point setting by pressing a pushbutton

Application sensors for special application areas

System components for fine adjustment



Laser sensors

Laser sensors are used where small objects or precise positions are to be detected. They are designed as through-beam sensors, retro-reflective sensors or diffuse reflection sensors.

Laser light consists of light waves of the same wave length with a fixed phase ratio (coherence). This characteristic constitutes an important feature of laser sensors: their almost perfectly parallel light beam. The result: Long ranges can be achieved thanks to the small angle of divergence. The laser spot which is even in daylight clearly visible makes it easier to align the system.

<i>System overview</i>	<i>Page</i>
Cylindrical OG housing (M18) Laser PerformanceLine, laser class 1	282
Rectangular housing OJ Laser PerformanceLine, lateral sensing face, laser class 1	282 - 283
Rectangular housing OJ Laser PerformanceLine, front sensing face, laser class 1	283
Rectangular housing O5 laser class 1	283 - 284
Rectangular housing O1 Laser PerformanceLine with background suppression, laser class 2	284
Prismatic reflector	284 - 285
Software	285
Accessories OG housing	285 - 286
Accessories O5 housing	286 - 287
Accessories O1 housing	287
Accessories for system components	288
Cylindrical OI housing (M30) for optical distance measurement, laser class 2	288 - 289
Cylindrical OI housing (M30) for optical distance measurement, laser class 1	289
Rectangular housing O5 for optical distance measurement, laser class 2	289 - 290
Rectangular housing O1 for optical distance measurement, laser class 1	290
Rectangular housing O1 for optical distance measurement, laser class 2	290
Rectangular housing O1 Laser PerformanceLine with background suppression, laser class 2	290 - 291
Rectangular housing O1 for optical level measurement, laser class 2	291
Accessories OI design (M30)	291 - 292
Accessories O5 housing	292
Accessories O1 housing	292 - 293
Wiring diagrams	293
Scale drawings / drawing no. – CAD download: www.ifm.com	294 - 296



Position sensors

Cylindrical OG housing (M18) Laser PerformanceLine, laser class 1

Type	Operating principle	Range	Type of light	Spot Ø at max. range [mm]	Output H = light-on D = dark-on	Wiring diagr. no.	Draw- ing no.	Order no.
------	---------------------	-------	---------------	---------------------------	---------------------------------------	-------------------------	---------------------	--------------

Through-beam sensor · M12 connector · 10...36 DC · high-grade stainless steel · IP65 / IP67 · Connector groups 8, 10, 19, 21, 23, 25, 148, 149, 153, 184, 188, 193, 202

	Transmitter	2 m	Red	5	–	1	1	OGS701
	Transmitter	60 m	Red	312	–	1	1	OGS700

Through-beam sensor · M12 connector · 10...36 DC · high-grade stainless steel · IP65 / IP67 · Connector groups 8, 10, 11, 18, 19, 21, 23, 25, 148, 149, 150, 153, 154, 184, 188, 190, 193, 202, 203, 204

	Receiver	2 m	Red	–	H/D PNP	2	2	OGE701
	Receiver	60 m	Red	–	H/D PNP	2	2	OGE700

Retro-reflective sensor · M12 connector · 10...36 DC · high-grade stainless steel · IP65 / IP67 · Connector groups 8, 10, 11, 18, 19, 21, 23, 25, 148, 149, 150, 153, 154, 184, 188, 190, 193, 202, 203, 204

	Polarisation filter	0.2...2 m	Red	5	H/D PNP	2	2	OGP701
	Polarisation filter	0.2...15 m	Red	78	H/D PNP	2	2	OGP700

Diffuse reflection sensor · M12 connector · 10...36 DC · high-grade stainless steel · IP65 / IP67 · Connector groups 8, 10, 11, 18, 19, 21, 23, 25, 148, 149, 150, 153, 154, 184, 188, 190, 193, 202, 203, 204

	Background suppression	20...200 mm	Red	1.2	H/D PNP	2	2	OGH700
--	------------------------	-------------	-----	-----	---------	---	---	--------

Rectangular housing OJ Laser PerformanceLine, lateral sensing face, laser class 1

Type	Operating principle	Range	Type of light	Spot Ø at max. range [mm]	Output H = light-on D = dark-on	Wiring diagr. no.	Draw- ing no.	Order no.
------	---------------------	-------	---------------	---------------------------	---------------------------------------	-------------------------	---------------------	--------------

Through-beam sensor · M8 connector · 10...30 DC · plastics · IP67 · Connector groups 4, 5, 80, 86, 147

	Transmitter	1 m	Red	< 4	–	1	3	OJ5141
	Receiver	1 m	Red	–	H/D PNP	3	3	OJ5142
	Transmitter	15 m	Red	< 24	–	1	3	OJ5138
	Receiver	15 m	Red	–	H/D PNP	3	3	OJ5139

Type	Operating principle	Range	Type of light	Spot Ø at max. range [mm]	Output H = light-on D = dark-on	Wiring diagr. no.	Draw- ing no.	Order no.
------	---------------------	-------	---------------	---------------------------	---------------------------------------	-------------------------	---------------------	--------------

Retro-reflective sensor · M8 connector · 10...30 DC · plastics · IP67 · Connector groups 4, 5, 80, 86, 147

	Polarisation filter	8 m	Red	< 12	H/D PNP	3	3	OJ5136
---	---------------------	-----	-----	------	---------	---	---	--------

Diffuse reflection sensor · M8 connector · 10...30 DC · plastics · IP67 · Connector groups 4, 5, 80, 86, 147

	Background suppression	7...150 mm	Red	0.8	H/D PNP	3	4	OJ5158
	Background suppression	15...200 mm	Red	2 x 1	H/D PNP	3	5	OJ5154



Rectangular housing OJ Laser PerformanceLine, front sensing face, laser class 1

Type	Operating principle	Range	Type of light	Spot Ø at max. range [mm]	Output H = light-on D = dark-on	Wiring diagr. no.	Draw- ing no.	Order no.
------	---------------------	-------	---------------	---------------------------	---------------------------------------	-------------------------	---------------------	--------------

Through-beam sensor · M8 connector · 10...30 DC · plastics · IP67 · Connector groups 4, 5, 80, 86, 147

	Transmitter	15 m	Red	< 24	–	1	6	OJ5116
	Receiver	15 m	Red	–	H/D PNP	3	6	OJ5117

Retro-reflective sensor · M8 connector · 10...30 DC · plastics · IP67 · Connector groups 4, 5, 80, 86, 147

	Polarisation filter	8 m	Red	< 12	H/D PNP	3	7	OJ5014
	Polarisation filter	8 m	Red	< 12	H/D PNP	3	6	OJ5114

Diffuse reflection sensor · M8 connector · 10...30 DC · plastics · IP67 · Connector groups 4, 5, 80, 86, 147

	Background suppression	15...200 mm	Red	2 x 1	H/D PNP	3	8	OJ5152
---	------------------------	-------------	-----	-------	---------	---	---	--------

Rectangular housing O5 laser class 1



Type	Operating principle	Range	Type of light	Spot Ø at max. range [mm]	Output H = light-on D = dark-on	Wiring diagr. no.	Draw- ing no.	Order no.
------	---------------------	-------	---------------	---------------------------	---------------------------------------	-------------------------	---------------------	--------------

Through-beam sensor · M12 connector · 10...36 DC · plastics · IP67 · Connector groups 8, 10, 19, 21, 23, 25, 148, 149, 153, 184, 188, 193, 202



	Transmitter	60 m	Red	150	–	1	9	O55700
---	-------------	------	-----	-----	---	---	---	--------







Position sensors





Type	Operating principle	Range	Type of light	Spot Ø at max. range [mm]	Output H = light-on D = dark-on	Wiring diagr. no.	Draw- ing no.	Order no.
Through-beam sensor · M12 connector · 10...36 DC · plastics · IP67 · Connector groups 8, 10, 11, 18, 19, 21, 23, 25, 148, 149, 150, 153, 154, 184, 188, 190, 193, 202, 203, 204								
	Receiver	60 m	Red	–	H/D PNP	2	10	O5E700
Retro-reflective sensor · M12 connector · 10...36 DC · plastics · IP67 · Connector groups 8, 10, 11, 18, 19, 21, 23, 25, 148, 149, 150, 153, 154, 184, 188, 190, 193, 202, 203, 204								
	Polarisation filter	15 m	Red	40	H/D PNP	2	11	O5P700
Diffuse reflection sensor · M12 connector · 10...36 DC · plastics · IP67 · Connector groups 8, 10, 11, 18, 19, 21, 23, 25, 148, 149, 150, 153, 154, 184, 188, 190, 193, 202, 203, 204								
	Background suppression	20...200 mm	Red	1.2	H/D PNP	2	12	O5H700

Rectangular housing O1 Laser PerformanceLine with background suppression, laser class 2

Type	Operating principle	Range	Type of light	Spot Ø at max. range [mm]	Output H = light-on D = dark-on	Wiring diagr. no.	Draw- ing no.	Order no.
Photoelectric distance sensor · M12 connector · 10...30 DC · metal · IP67 · Connector groups 8, 10, 11, 18, 19, 21, 23, 25, 148, 149, 150, 153, 154, 184, 188, 190, 193, 202, 203, 204								
	Background suppression	0.2...10 m	–	< 15 x 15	normally open / closed programmable PNP	2	13	O1D101
Photoelectric distance sensor · M12 connector · 10...30 DC · metal · IP67 · Connector groups 8, 10, 19, 21, 23, 25, 148, 149, 153, 184, 188, 193, 202								
	Background suppression	0.2...10 m	–	< 15 x 15	normally open / closed programmable NPN	4	13	O1D104

Prismatic reflector

Type	Description	Order no.
	Prismatic reflector · Ø 10 mm · round · fixing by screw · M3 · for retro-reflective laser sensors · Housing materials: screw: stainless steel 316 / 1.4401 / spring washer: stainless steel 316 / 1.4401 / nut: stainless steel 316 / 1.4401 / front plate: PMMA / base: ABS	E20990
	Prismatic reflector · Ø 15 mm · round · fixing by screw · M3 · for retro-reflective laser sensors · Housing materials: screw: stainless steel 316 / 1.4401 / spring washer: stainless steel 316 / 1.4401 / nut: stainless steel 316 / 1.4401 / front plate: PMMA / base: ABS	E20992
	Prismatic reflector · Ø 19 mm · round · fixing by screw · M3 · for retro-reflective laser sensors · Housing materials: screw: stainless steel 316 / 1.4401 / spring washer: stainless steel 316 / 1.4401 / nut: stainless steel 316 / 1.4401 / front plate: PMMA / base: ABS	E20993
	Prismatic reflector · 11 x 11 mm · rectangular · fixing by screw · M3 · for retro-reflective laser sensors · Housing materials: screw: stainless steel 316 / 1.4401 / spring washer: stainless steel 316 / 1.4401 / nut: stainless steel 316 / 1.4401 / front plate: PMMA / base: ABS	E20991

Type	Description	Order no.
	Prismatic reflector · 14 x 23 mm · rectangular · for retro-reflective laser sensors · Housing materials: front plate: PMMA / base: ABS	E20989
	Prismatic reflector · 30 x 20 mm · rectangular · for retro-reflective laser sensors · Housing materials: front plate: PMMA / base: ABS	E20994
	Prismatic reflector · 50 x 10 mm · rectangular · for retro-reflective laser sensors · Housing materials: front plate: PMMA / base: ABS	E20988
	Prismatic reflector · 48 x 48 mm · rectangular · for retro-reflective laser sensors and glass and film detection · Housing materials: plastics	E20722

Software



Type	Description	Order no.
	LR DEVICE (USB stick) · Parameter setting of the units via the network · Software for clear online and offline parameter setting of IO-Link sensors via USB adapter · Use via USB connection cable (drivers are supplied): E30396 IO-Link interface or E30390 IO-Link master (note the respective data sheet) · IODD import and update from ifm's homepage · Reading of IODDs via storage media · Automatic sensor identification · Graphic representation of the process values and history incl. export function · Documentation and archiving · Transferable parameter sets · Full memory plug support for IO-Link 1.1	QA0011
	LR DEVICE (download) · Parameter setting of the units via the network · Software for clear online and offline parameter setting of IO-Link sensors via USB adapter · Use via USB connection cable (drivers are supplied): E30396 IO-Link interface or E30390 IO-Link master (note the respective data sheet) · IODD import and update from ifm's homepage · Reading of IODDs via storage media · Automatic sensor identification · Graphic representation of the process values and history incl. export function · Documentation and archiving · Transferable parameter sets · Full memory plug support for IO-Link 1.1	QA0012

Accessories OG housing

Type	Description	Order no.
	Mounting and fine adjustment bracket for laser units · Ø 18.5 mm · Clamp mounting · rod or free-standing depending on the clamp · for type OG · Housing materials: stainless steel 316Ti / 1.4571	E20737
	Mounting and fine adjustment bracket for laser units · Ø 18.5 mm · Clamp mounting · rod mounting Ø 12 mm · for type OG · Housing materials: fixture: stainless steel 316Ti / 1.4571 / clamp: high-grade stainless steel	E21220
	Mounting and fine adjustment bracket for laser units · Ø 18.5 mm · Clamp mounting · rod mounting Ø 12 mm · for type OG · Housing materials: fixture: stainless steel 316Ti / 1.4571 / clamp: diecast zinc	E21219
	Mounting set · Ø 18.5 mm · Clamp mounting · rod mounting Ø 12 mm · for type OG, IG, KG · Housing materials: clamp: diecast zinc / fixture: steel	E20720
	Mounting set · Ø 18.5 mm · Clamp mounting · rod mounting Ø 12 mm · for type OG, IG, KG · Housing materials: clamp: diecast zinc / fixture: steel	E20721







Position sensors







Type	Description	Order no.
	Mounting set · Ø 18.5 mm · Clamp mounting · rod mounting Ø 12 mm · for type OG, IG, KG · Housing materials: clamp: high-grade stainless steel / fixture: high-grade stainless steel	E21206
	Mounting set · Ø 18.5 mm · Clamp mounting · rod mounting Ø 12 mm · for type OG, IG, KG · Housing materials: clamp: high-grade stainless steel / fixture: high-grade stainless steel	E21207

Accessories O5 housing

Type	Description	Order no.
	Angle bracket · for type O5 · Housing materials: stainless steel 316Ti / 1.4571	E21087
	Angle bracket · for type O5 · Housing materials: stainless steel 316Ti / 1.4571	E21085
	Angle bracket · O5, O4 · for mounting O5, O4 sensors instead of OL sensors · Dovetail clamp · Housing materials: Dovetail clamp: AlMgSi0.5 / fixture: AlMg3	E21122
	Dovetail clamp · for type DTS, O4, O5 · Housing materials: AlMgSi0.5	E21088
	Mounting brackets Mounting on the back of the unit · for type O5 · Housing materials: stainless steel 316Ti / 1.4571	E21086
	Mounting sleeve · O5 · for mounting O5 sensors instead of OC sensors · Housing materials: AlZnMgCu1.5 F51/52	E21114
	Mounting and fine adjustment bracket for laser units · Clamp mounting · rod or free-standing depending on the clamp · for type O5 · Housing materials: stainless steel 316Ti / 1.4571	E20794
	Mounting set · Clamp mounting · With protective cover · rod mounting Ø 12 mm · for type O5 · Housing materials: fixture: stainless steel 316Ti / 1.4571 / clamp: high-grade stainless steel	E21223
	Mounting set · Clamp mounting · With protective cover · rod mounting Ø 12 mm · for type O5 · Housing materials: stainless steel 316Ti / 1.4571 / clamp: diecast zinc	E21210
	Mounting set · Clamp mounting · rod mounting Ø 12 mm · for type O5, O5D · Housing materials: stainless steel 316Ti / 1.4571 / clamp: diecast zinc	E21211
	Mounting set · Clamp mounting · rod mounting Ø 12 mm · for type O5, O5D · Housing materials: stainless steel 316Ti / 1.4571 / clamp: high-grade stainless steel	E21212

Type	Description	Order no.
	Mounting set · Clamp mounting · With protective cover · rod mounting Ø 14 mm · for type O5 · Housing materials: fixture: stainless steel 316Ti / 1.4571 / clamp: stainless steel	E21142
	Mounting set · Clamp mounting · With protective cover · Free-standing M10 · for type O5 · Housing materials: stainless steel 316Ti / 1.4571 / clamp: diecast zinc	E21084
	Mounting set · Clamp mounting · Free-standing M10 · for type O5 · Housing materials: stainless steel 316Ti / 1.4571 / clamp: diecast zinc	E21083
	Memory plug · Parameter memory for IO-Link sensors · Storage capacity: 2 Kbytes · Housing materials: PA PACM 12 / PET / sealing: FPM / nut: stainless steel 316L / 1.4404 / connector: TPU	E30398



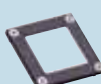



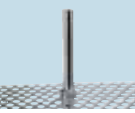

Accessories O1 housing

Type	Description	Order no.
	Prismatic reflector · 226 x 262 mm · rectangular · Housing materials: plastics	E21159
	Mounting adapter · O1D · for optical distance sensors · for type O1D · Housing materials: flange: stainless steel 316L / 1.4404 / sealing: FKM / Protective cover: PMMA transparent / screws: high-grade stainless steel / washers: high-grade stainless steel	E21224
	Mounting and fine adjustment bracket for laser units · O1D · Clamp mounting · rod or free-standing depending on the clamp · Housing materials: fixture: aluminium transparent anodised / plastics: POM / screws: stainless steel	E1D100
	Mounting set · E2D101 + E20938 + E20951	E21079
	Angle bracket · O1D, O4 · for type O1D, O4 · Housing materials: stainless steel 316L / 1.4404	E21120
	Protective bracket · O1D · for type O1D · Housing materials: Angle bracket: stainless steel 316 / 1.4401 / screws: stainless steel / housing: polyamide	E21236
	Protective cover · O1D · Housing materials: bezel: ZnAl4Cu1 finish black / window: PMMA transparent and colourless / sealing: FPM 75+/-5 Shore A black / screws: stainless steel	E21133
	Protective cover · O1D · Housing materials: bezel: ZnAl4Cu1 finish black / window: glass transparent and colourless / sealing: FPM 75+/-5 Shore A black / screws: stainless steel	E21171

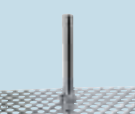





Position sensors

Accessories for system components

Type	Description	Order no.
	mounting rod · Ø 10 / M8 · Length: 150 mm · straight · Housing materials: stainless steel 316Ti / 1.4571	E21081
	mounting rod · Ø 10 / M8 · Length: 200 mm · angled · Housing materials: stainless steel 316Ti / 1.4571	E80310
	mounting rod · Ø 12 / M10 · Length: 130 mm · straight · Housing materials: stainless steel 316Ti / 1.4571	E20938
	mounting rod · Ø 12 / M10 · Length: 200 mm · angled · Housing materials: stainless steel 316Ti / 1.4571	E20940
	Head cap screw · M8 x 40 mm · ISO 4762 (DIN 912) · free-standing M8 · Housing materials: screw: steel galvanised	E21204
	Head cap screw · M10 x 45 mm · ISO 4762 (DIN 912) · Free-standing M10 · Housing materials: screw: steel galvanised	E21208
	Head cap screw · M10 x 45 mm · ISO 4762 (DIN 912) · Free-standing M10 · Housing materials: screw: high-grade stainless steel	E21209
	Cube · M10 · aluminium profile · Housing materials: diecast zinc	E20951

Cylindrical OI housing (M30) for optical distance measurement, laser class 2

Type	Operating principle	Range	Type of light	Spot Ø at max. range [mm]	Output H = light-on D = dark-on	Wiring diagr. no.	Draw- ing no.	Order no.
Photoelectric distance sensor · M12 connector · 10...30 DC · metal · IP65 / IP67 · Display unit: cm, inch · Connector groups 8, 10, 19, 21, 23, 25, 148, 149, 153, 184, 188, 193, 202								
	Background suppression	0.03...2 m	Red	< 5	2 switching outputs normally open / closed complementary PNP	5	14	OID200
Photoelectric distance sensor · M12 connector · 10...30 DC · metal · IP65 / IP67 · Display unit: cm · Connector groups 8, 10, 19, 21, 23, 25, 148, 149, 153, 184, 188, 193, 202								
	Background suppression	0.03...2 m	Red	< 5	2 switching outputs normally open / closed complementary PNP	5	14	OID201
Photoelectric distance sensor · M12 connector · 10...30 DC · metal · IP65 / IP67 · Display unit: cm, inch · Connector groups 8, 10, 19, 21, 23, 25, 148, 149, 153, 184, 188, 193, 202								
	Background suppression	0.03...2 m	Red	< 5	2 switching outputs normally open / closed complementary NPN	6	14	OID202

Type	Operating principle	Range	Type of light	Spot Ø at max. range [mm]	Output H = light-on D = dark-on	Wiring diagr. no.	Draw- ing no.	Order no.
Photoelectric distance sensor · M12 connector · 10...30 DC · metal · IP65 / IP67 / IP68 / IP69K · Display unit: cm · Connector groups 12, 13, 22, 24, 150, 152, 154, 155, 186, 190, 192, 194, 205								
	Background suppression	0.03...2 m	Red	< 5	2 switching outputs normally open / closed complementary PNP	7	15	OID204

Cylindrical OI housing (M30) for optical distance measurement, laser class 1

Type	Operating principle	Range	Type of light	Spot Ø at max. range [mm]	Output H = light-on D = dark-on	Wiring diagr. no.	Draw- ing no.	Order no.
Photoelectric distance sensor · M12 connector · 10...30 DC · metal · IP65 / IP67 · Display unit: cm, inch · Connector groups 8, 10, 19, 21, 23, 25, 148, 149, 153, 184, 188, 193, 202								
	Background suppression	0.03...2 m	Red	< 5	2 switching outputs normally open / closed complementary PNP	5	14	OID250

Photoelectric distance sensor · M12 connector · 10...30 DC · metal · IP65 / IP67 · Display unit: cm · Connector groups 8, 10, 19, 21, 23, 25, 148, 149, 153, 184, 188, 193, 202								
	Background suppression	0.03...2 m	Red	< 5	2 switching outputs normally open / closed complementary PNP	5	14	OID251

Photoelectric distance sensor · M12 connector · 10...30 DC · metal · IP65 / IP67 / IP68 / IP69K · Display unit: cm · Connector groups 12, 13, 22, 24, 150, 152, 154, 155, 186, 190, 192, 194, 205								
	Background suppression	0.03...2 m	Red	< 5	2 switching outputs normally open / closed complementary PNP	7	15	OID254

Rectangular housing O5 for optical distance measurement, laser class 2

Type	Operating principle	Range	Type of light	Spot Ø at max. range [mm]	Output H = light-on D = dark-on	Wiring diagr. no.	Draw- ing no.	Order no.
Photoelectric distance sensor · M12 connector · 10...30 DC · metal · IP65 / IP67 · Display unit: cm · Connector groups 8, 10, 19, 21, 23, 25, 148, 149, 153, 184, 188, 193, 202								
	Background suppression	0.03...2 m	Red	< 5	2 switching outputs normally open / closed complementary PNP	5	16	O5D100

Photoelectric distance sensor · M12 connector · 10...30 DC · metal · IP65 / IP67 · Display unit: inch · Connector groups 8, 10, 19, 21, 23, 25, 148, 149, 153, 184, 188, 193, 202								
	Background suppression	0.03...2 m	Red	< 5	2 switching outputs normally open / closed complementary PNP	5	16	O5D101

Photoelectric distance sensor · M12 connector · 10...30 DC · metal · IP65 / IP67 · Display unit: cm · Connector groups 8, 10, 19, 21, 23, 25, 148, 149, 153, 184, 188, 193, 202								
	Background suppression	0.03...2 m	Red	< 5	2 switching outputs normally open / closed complementary NPN	6	16	O5D102

	Background suppression	0.03...2 m	Red	< 5	2 switching outputs normally open / closed complementary PNP	5	16	O5D150
---	------------------------	------------	-----	-----	---	---	----	---------------



Position sensors

Type	Operating principle	Range	Type of light	Spot Ø at max. range [mm]	Output H = light-on D = dark-on	Wiring diagr. no.	Draw- ing no.	Order no.
------	---------------------	-------	---------------	---------------------------	---------------------------------------	-------------------------	---------------------	--------------

Photoelectric distance sensor · M12 connector · 10...30 DC · metal · IP65 / IP67 · Display unit: inch · Connector groups 8, 10, 19, 21, 23, 25, 148, 149, 153, 184, 188, 193, 202

	Background suppression	0.03...2 m	Red	< 5	2 switching outputs normally open / closed complementary PNP	5	16	O5D151
---	------------------------	------------	-----	-----	---	---	----	---------------

Rectangular housing O1 for optical distance measurement, laser class 1

Type	Operating principle	Range	Sampling rate [Hz]	Spot Ø at max. range [mm]	U _b [V]	Wiring diagr. no.	Draw- ing no.	Order no.
------	---------------------	-------	--------------------------	------------------------------------	-----------------------	-------------------------	---------------------	--------------

Output function OUT1: normally open / closed programmable OUT2: normally open / closed programmable or analogue (4...20 mA / 0...10 V, scalable) · Wiring diagram no. 8 · Connector groups 8, 10, 19, 21, 23, 25, 148, 149, 153, 184, 188, 193, 202

	Photoelectric distance sensor	0.3...6 m	1...33	< 8 x 8	18...30	8	13	O1D155
---	-------------------------------	-----------	--------	---------	---------	---	----	---------------

Rectangular housing O1 for optical distance measurement, laser class 2

Type	Operating principle	Range	Sampling rate [Hz]	Spot Ø at max. range [mm]	U _b [V]	Wiring diagr. no.	Draw- ing no.	Order no.
------	---------------------	-------	--------------------------	------------------------------------	-----------------------	-------------------------	---------------------	--------------

Output function OUT1: normally open / closed programmable OUT2: normally open / closed programmable or analogue (4...20 mA / 0...10 V, scalable) · Wiring diagram no. 8 · Connector groups 8, 10, 19, 21, 23, 25, 148, 149, 153, 184, 188, 193, 202

	Photoelectric distance sensor	1...75 m on reflector E21159	1...33	< 150 x 150	18...30	8	13	O1D106
	Photoelectric distance sensor	0.2...10 m	1...33	< 15 x 15	18...30	8	13	O1D105

Output function OUT1: normally open / closed programmable OUT2: normally open / closed programmable or analogue (4...20 mA / 0...10 V, scalable) · Wiring diagram no. 9 · Connector groups 12, 13, 22, 24, 150, 152, 154, 155, 186, 190, 192, 194, 205

	Background suppression	0.2...10 m	1...50	< 15 x 15	18...30	9	13	O1D100
---	------------------------	------------	--------	-----------	---------	---	----	---------------

Output function OUT1: normally open / closed programmable OUT2: normally open / closed programmable or analogue (4...20 mA / 0...10 V, scalable) · Wiring diagram no. 10 · Connector groups 12, 13, 22, 24, 152, 155, 186, 192, 194, 205

	Photoelectric distance sensor	0.2...10 m	1...50	< 15 x 15	18...30	10	13	O1D103
---	-------------------------------	------------	--------	-----------	---------	----	----	---------------

Rectangular housing O1 Laser PerformanceLine with background suppression, laser class 2

Type	Operating principle	Range	Type of light	Spot Ø at max. range [mm]	Output H = light-on D = dark-on	Wiring diagr. no.	Draw- ing no.	Order no.
------	---------------------	-------	---------------	------------------------------------	---------------------------------------	-------------------------	---------------------	--------------

Photoelectric distance sensor · M12 connector · 10...30 DC · metal · IP67 · Connector groups 8, 10, 11, 18, 19, 21, 23, 25, 148, 149, 150, 153, 154, 184, 188, 190, 193, 202, 203, 204

	Background suppression	0.2...10 m	–	< 15 x 15	normally open / closed programmable PNP	2	13	O1D101
---	------------------------	------------	---	-----------	---	---	----	---------------

Product selectors and further information can be found at: www.ifm.com

Type	Operating principle	Range	Type of light	Spot Ø at max. range [mm]	Output H = light-on D = dark-on	Wiring diagr. no.	Draw- ing no.	Order no.
------	---------------------	-------	---------------	---------------------------	---------------------------------------	-------------------------	---------------------	--------------

Photoelectric distance sensor · M12 connector · 10...30 DC · metal · IP67 · Connector groups 8, 10, 19, 21, 23, 25, 148, 149, 153, 184, 188, 193, 202

	Background suppression	0.2...10 m	–	< 15 x 15	normally open / closed programmable NPN	4	13	O1D104
---	------------------------	------------	---	-----------	--	---	----	---------------

Photoelectric distance sensor · M12 connector · 18...30 DC · metal · IP67 · Connector groups 12, 13, 22, 24, 150, 152, 154, 155, 186, 190, 192, 194, 205

	Background suppression	0.2...10 m	–	< 15 x 15	OUT1: normally open/closed progr. OUT2: normally open/closed progr. or analogue (4...20 mA / 0...10 V, scalable) PNP	9	13	O1D120
---	------------------------	------------	---	-----------	---	---	----	---------------

Rectangular housing O1 for optical level measurement, laser class 2

Type	Operating principle	Range	Sampling rate [Hz]	Spot Ø at max. range [mm]	U _b [V]	Wiring diagr. no.	Draw- ing no.	Order no.
------	---------------------	-------	--------------------	---------------------------	--------------------	-------------------------	---------------------	--------------

Output function OUT1: normally open / closed programmable OUT2: normally open / closed programmable or analogue (4...20 mA / 0...10 V, scalable) · Wiring diagram no. 8 · Connector groups 8, 10, 19, 21, 23, 25, 148, 149, 153, 184, 188, 193, 202

	Optical level sensor	0.2...10 m	1...33	< 15 x 15	18...30	8	13	O1D300
---	----------------------	------------	--------	-----------	---------	---	----	---------------

Accessories O1 design (M30)

Type	Description	Order no.
------	-------------	-----------

	Mounting set · Clamp mounting · Free-standing M10 · for type O5 · Housing materials: stainless steel 316Ti / 1.4571 / clamp: diecast zinc	E21083
---	---	---------------

	Mounting set · Clamp mounting · With protective cover · Free-standing M10 · for type O5 · Housing materials: stainless steel 316Ti / 1.4571 / clamp: diecast zinc	E21084
---	---	---------------

	mounting rod · Ø 12 / M10 · Length: 130 mm · straight · Housing materials: stainless steel 316Ti / 1.4571	E20938
---	---	---------------

	Cube · M10 · aluminium profile · Housing materials: diecast zinc	E20951
---	--	---------------

	Angle bracket · for type O5 · Housing materials: stainless steel 316Ti / 1.4571	E21085
---	---	---------------

	Angle bracket · for type O5 · Housing materials: stainless steel 316Ti / 1.4571	E21087
---	---	---------------









	Dovetail clamp · for type DTS, O4, O5 · Housing materials: AlMgSi0.5	E21088
---	--	---------------





Position sensors

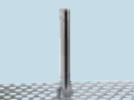

Type	Description	Order no.
	Memory plug · Parameter memory for IO-Link sensors · Storage capacity: 2 Kbytes · Housing materials: PA PACM 12 / PET / sealing: FPM / nut: stainless steel 316L / 1.4404 / connector: TPU	E30398

Accessories O5 housing

Type	Description	Order no.
	Angle bracket · for type M30 · Housing materials: stainless steel	E10737
	Mounting clamp · Ø 30 mm · with end stop · for type M30 · Housing materials: PC	E11049
	Mounting clamp · Ø 34 mm - Ø 30 mm · with reducing bush · for type M30 · Housing materials: PBT	E10077
	Mounting set · Ø 30.2 mm · Clamp mounting · aluminium profile · for type II, KI, OID, OI · Housing materials: fixture: stainless steel 316Ti / 1.4571 / clamp: diecast zinc / Cube: diecast zinc	E20875
	Mounting set · Ø 30.2 mm · Clamp mounting · free-standing M12 · for type OI, II, KI · Housing materials: fixture: stainless steel 316Ti / 1.4571 / clamp: diecast zinc	E20873
	Mounting set · Ø 30.2 mm · Clamp mounting · free-standing M12 · for type OI, II, KI · Housing materials: fixture: stainless steel 316Ti / 1.4571 / clamp: stainless steel	E20874
	mounting rod · Ø 12 / M10 · Length: 130 mm · straight · Housing materials: stainless steel 316Ti / 1.4571	E20938
	Cube · M10 · aluminium profile · Housing materials: diecast zinc	E20951
	Memory plug · Parameter memory for IO-Link sensors · Storage capacity: 2 Kbytes · Housing materials: PA PACM 12 / PET / sealing: FPM / nut: stainless steel 316L / 1.4404 / connector: TPU	E30398

Accessories O1 housing

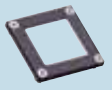
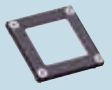
Type	Description	Order no.
	Prismatic reflector · 226 x 262 mm · rectangular · Housing materials: plastics	E21159
	Mounting and fine adjustment bracket for laser units · O1D · Clamp mounting · rod or free-standing depending on the clamp · Housing materials: fixture: aluminium transparent anodised / plastics: POM / screws: stainless steel	E1D100

Type	Description	Order no.
	Mounting set · E2D101 + E20938 + E20951	E21079
	Protective cover · O1D · Housing materials: bezel: ZnAl4Cu1 finish black / window: PMMA transparent and colourless / sealing: FPM 75+/-5 Shore A black / screws: stainless steel	E21133
	Protective cover · O1D · Housing materials: bezel: ZnAl4Cu1 finish black / window: glass transparent and colourless / sealing: FPM 75+/-5 Shore A black / screws: stainless steel	E21171
	Cooling box · Protective housing with an active cooling system for the O1D design · for type O1D · Housing materials: housing: aluminium transparent anodised / cover: aluminium black anodised / bezel: aluminium black anodised / window: float glass / cable gland: Brass nickel-plated / nozzle: Brass nickel-plated / sealing: FPM	E21248
	Cable · 10 m	E12274

Wiring diagrams

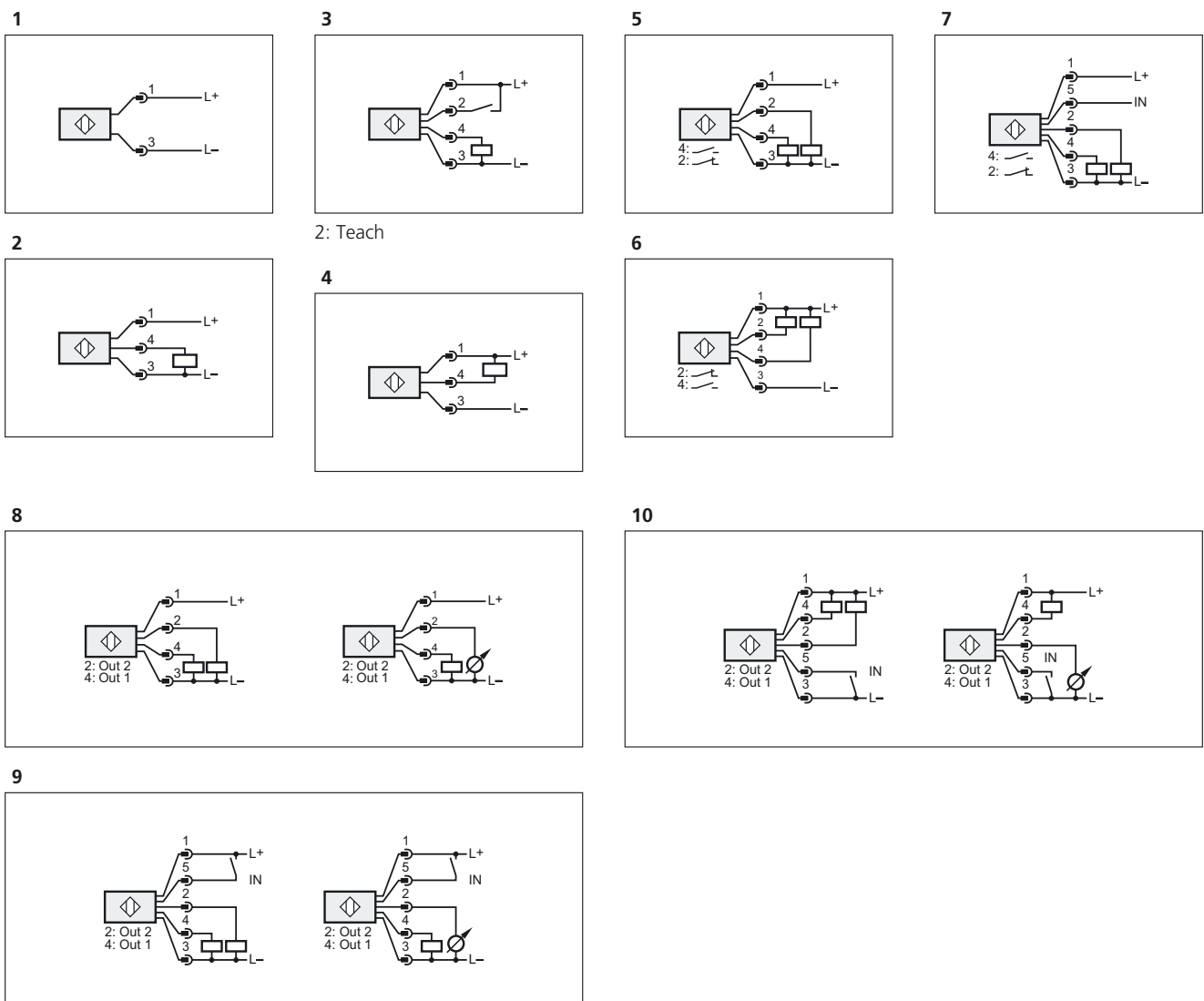



Position sensors

Scale drawings / drawing no. – CAD download: www.ifm.com

1

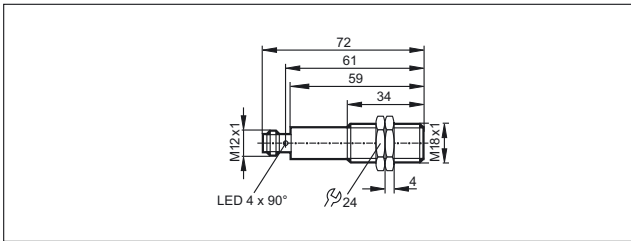

2

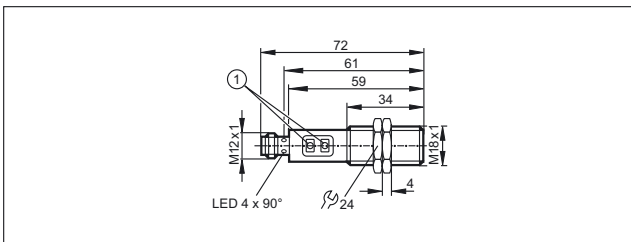

1: Programming buttons

3

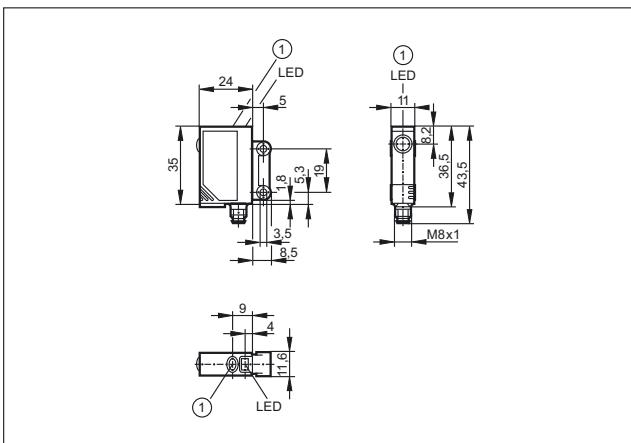

1: pushbutton

4

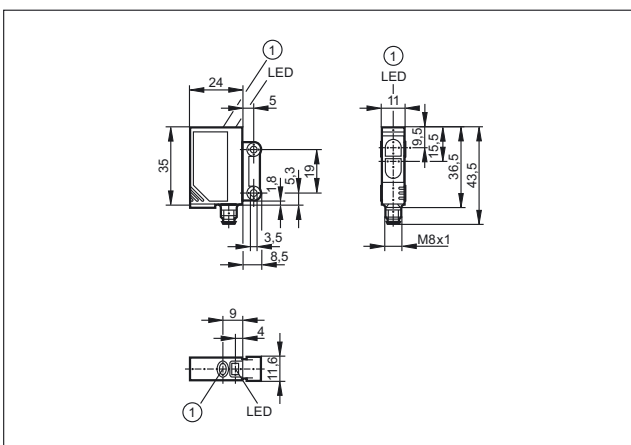

1: pushbutton

5

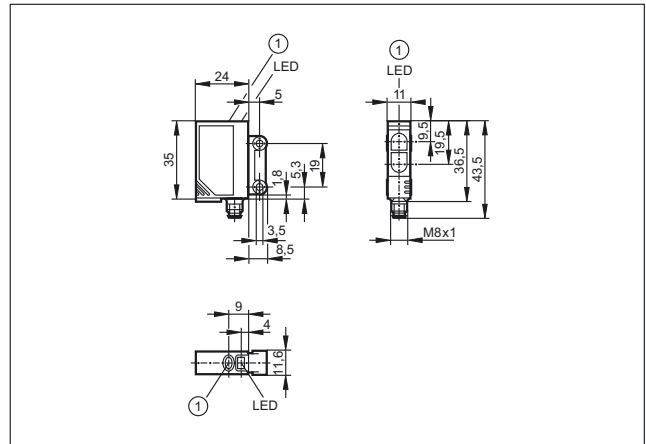

1: pushbutton

6

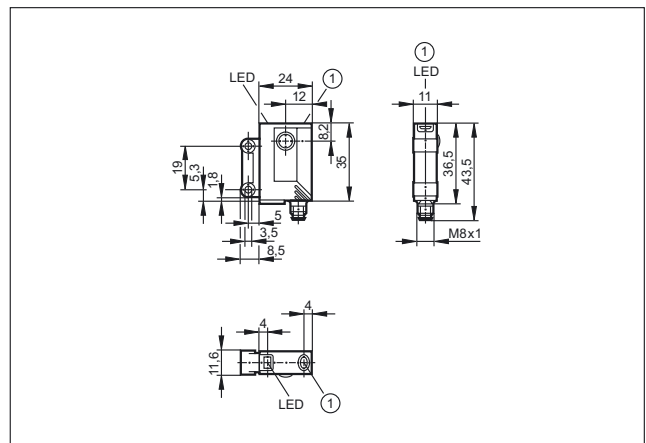

1: pushbutton

7

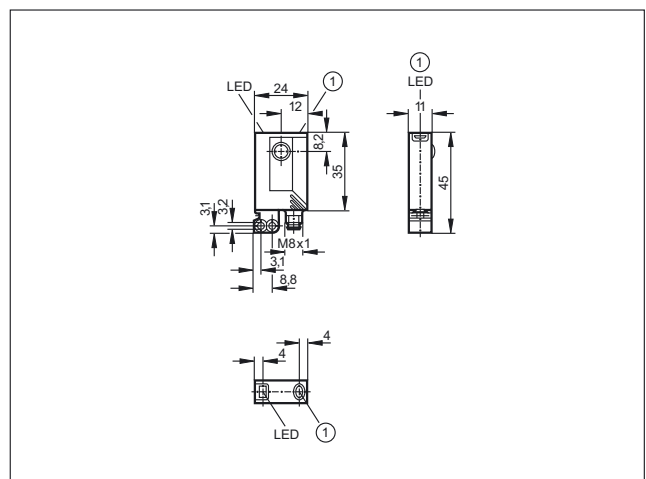

1: pushbutton

Scale drawings / drawing no. – CAD download: www.ifm.com

8

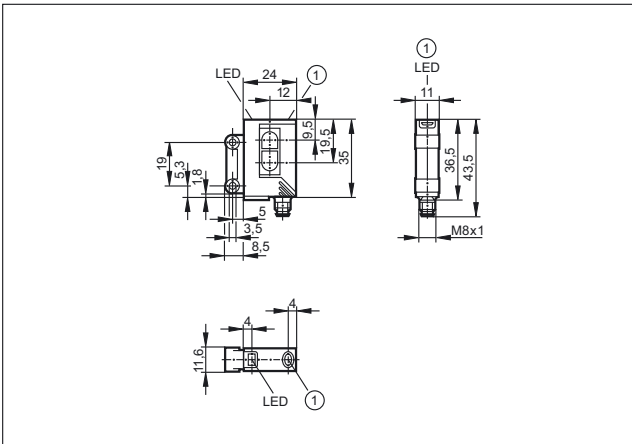

1: pushbutton

9

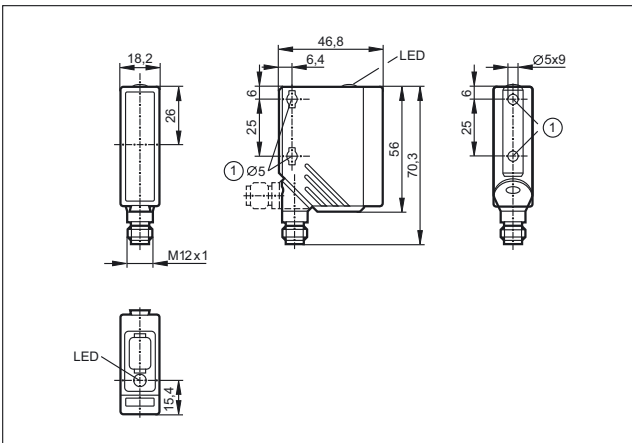

10

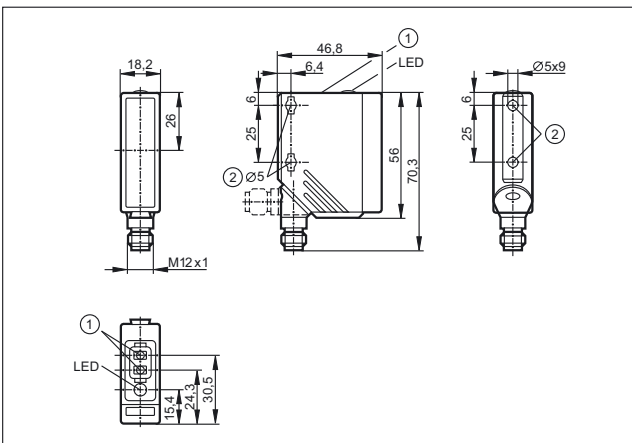

11

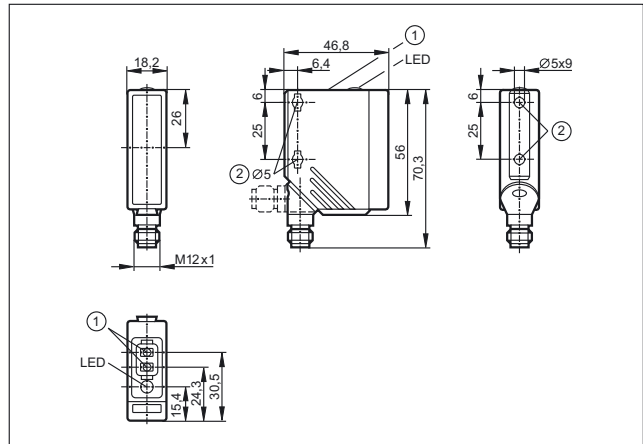

1: Programming buttons, 2: When a M5 mounting screw is used, the max. tightening torque is 2 Nm.

12

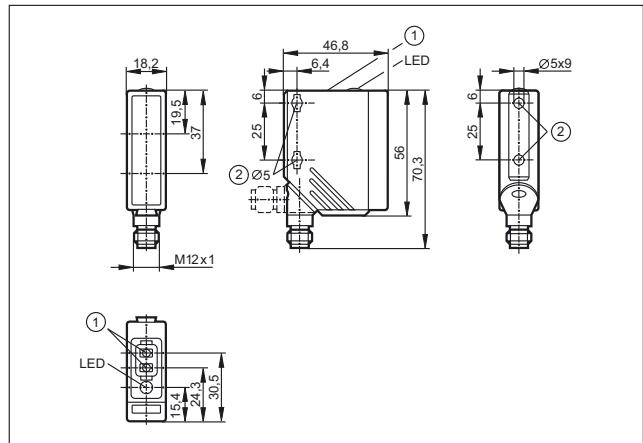

1: Programming buttons, 2: When a M5 mounting screw is used, the max. tightening torque is 2 Nm.

13

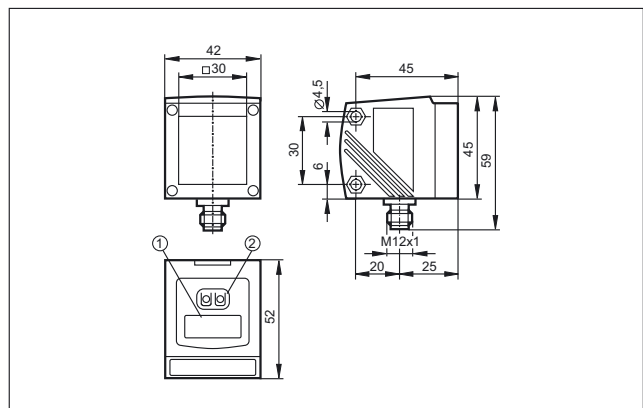

1: 4-digit alphanumeric display, 2: Programming buttons

14

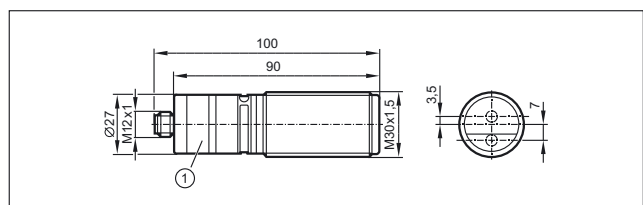



Position sensors

Scale drawings / drawing no. – CAD download: www.ifm.com

15

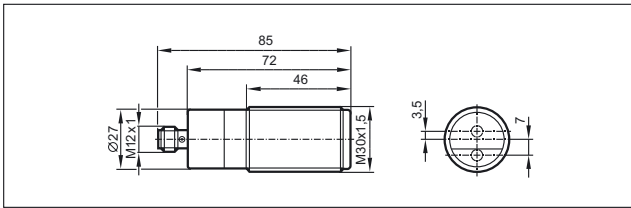

16

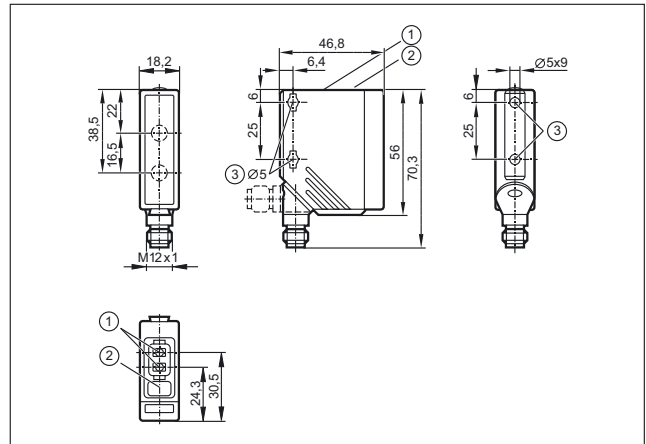





Fibre optics and amplifiers for the smallest of spaces



Fibre optic sensors



Easy connection of different fibre optics

Manual or automatic setting via pushbutton

LED display to check operation, switching status and function

Various fibre materials for different applications

Easy mounting on DIN rail possible



Fibre optics systems

If there is only little mounting space for standard photoelectric sensors, fibre optics can be used. They are connected via fibre optic amplifiers which contain the control monitor and photoelectric components. Both the through-beam and the sensing principle are applied.

Fibre-optics materials

Fibre optics made of silicate glass are particularly resistant to heat and ageing, their optical response does not change when they are bent. They cannot be cut to length by the user.

Acrylic fibre optics are suited for standard applications, they can be cut to length and are less expensive than glass fibre optics.

High-flex fibre optics allow extremely small bending radii.

System overview	Page
OOF amplifiers for acrylic fibre optics	300
OBF amplifiers for acrylic fibre optics	300
Acrylic fibre optics for OBF / OOF housings, through-beam system	301
Acrylic fibre optics for OBF / OOF housings, through-beam system, highly flexible	301
Acrylic fibre optics for OBF / OOF housings, diffuse reflection system	302
Acrylic fibre optics for OBF / OOF housings, diffuse reflection system, highly flexible	303
Acrylic fibre optics for OBF / OOF housings, through-beam system, can be cut to length	303
Acrylic fibre optics for OBF / OOF housings, diffuse reflection system, can be cut to length	303
Acrylic fibres on a reel for OBF housing	303
OOF amplifiers for glass fibre optics	304
OKF amplifiers for glass fibre optics	304
OUF amplifiers for glass fibre optics	304 - 305
Glass fibre optics for OOF / OKF and OUF housings, through-beam system	305 - 306
Glass fibre optics for OOF / OKF and OUF housings, diffuse reflection system	306 - 307
Accessories	307 - 308
Wiring diagrams	308 - 309
Scale drawings / drawing no. – CAD download: www.ifm.com	309 - 315



Position sensors

OOF amplifiers for acrylic fibre optics

Type	Number of input channels	For fibre optics	Type of light	Sensing range through beam	Sensing range diffuse	Output H = light-on D = dark-on	U _b [V]	Drawing no.	Order no.
------	--------------------------	------------------	---------------	----------------------------	-----------------------	---------------------------------------	-----------------------	-------------	-----------

Type OOF · M12 connector · plastics · DC · Wiring diagram no. 1 · Connector groups 14, 16, 17

	2	FE/FT-11	Red	3.8 m	0...300 mm	H/D PNP	12...36	1	OO5000
---	---	----------	-----	-------	------------	---------	---------	---	--------

Type OOF · M12 connector · plastics · DC · Wiring diagram no. 6 · Connector groups 16, 17

	4	FE/FT-11	Red	3.8 m	0...300 mm	H/D PNP	12...36	2	OO5001
---	---	----------	-----	-------	------------	---------	---------	---	--------

Type OOF · M16 connector · plastics · DC · Wiring diagram no. 7 · Connector group 27

	6	FE/FT-11	Red	3.8 m	0...300 mm	H/D PNP	12...36	3	OO5002
---	---	----------	-----	-------	------------	---------	---------	---	--------

Type OOF · M16 connector · plastics · DC · Wiring diagram no. 8 · Connector group 27

	8	FE/FT-11	Red	3.8 m	0...300 mm	H/D PNP	12...36	4	OO5003
---	---	----------	-----	-------	------------	---------	---------	---	--------

OBF amplifiers for acrylic fibre optics

Type	Number of input channels	For fibre optics	Type of light	Sensing range through beam	Sensing range diffuse	Output H = light-on D = dark-on	U _b [V]	Drawing no.	Order no.
------	--------------------------	------------------	---------------	----------------------------	-----------------------	---------------------------------------	-----------------------	-------------	-----------

Type OBF · M12 connector · plastics · DC · Wiring diagram no. 9 · Connector groups 8, 10, 19, 21, 23, 25, 148, 149, 153, 184, 188, 193, 202

	1	FE/FT-11	Red	0...2 m	0...100 mm	H/D PNP/NPN	10...30	5	OBF500
---	---	----------	-----	---------	------------	-------------	---------	---	--------

Type OBF · M8 connector · plastics · DC · Wiring diagram no. 9 · Connector groups 4, 5, 80, 86, 147

	1	FE/FT-11	Red	0...2 m	0...100 mm	H/D PNP/NPN	10...30	6	OBF501
---	---	----------	-----	---------	------------	-------------	---------	---	--------









Type OBF · Cable 2 m · plastics · DC · Wiring diagram no. 10

	1	FE/FT-11	Red	0...2 m	0...100 mm	H/D PNP/NPN	10...30	7	OBF502
---	---	----------	-----	---------	------------	-------------	---------	---	--------

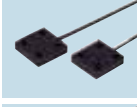

Type OBF · M8 connector · plastics · DC · Wiring diagram no. 11 · Connector groups 1, 3, 145

	1	FE/FT-11	Red	0...2 m	0...100 mm	H/D PNP/NPN	10...30	6	OBF503
---	---	----------	-----	---------	------------	-------------	---------	---	--------

Acrylic fibre optics for OBF / OOF housings, through-beam system

Type	System	Fibre optic material	Range OB50.. / OBF5.. / OO50.. [mm]	Sensing head material	Ambient temperature [°C]	Sheathing material	Drawing no.	Order no.
	FE-11	PMMA	60 / 130 / 160	aluminium	-40...70	PE (polyethylene)	8	E20609
	FE-11	PMMA	60 / 130 / 160	aluminium	-40...70	PE (polyethylene)	9	E20612
	FE-11	PMMA	150 / 210 / 800	aluminium	-40...70	PE (polyethylene)	9	E20615
	FE-11	PMMA	150 / 300 / 700	aluminium	-40...70	PE (polyethylene)	10	E20757
	FE-11	PMMA	200 / 350 / 800	aluminium	-40...70	PE (polyethylene)	11	E20603
	FE-11	PMMA	200 / 450 / 800	aluminium	-40...70	PE (polyethylene)	9	E20606
	FE-11	PMMA	400 / 900 / 1600	aluminium	-40...70	PE (polyethylene)	12	E20753
	FE-11	PMMA	1200 / 2000 / 3800	aluminium	-40...70	PE (polyethylene)	13	E20752
	FE-11	PMMA	140 / 230 / 400	stainless steel	-40...70	PE (polyethylene)	14	E20714
	FE-11	PMMA	200 / 450 / 800	stainless steel 316L / 1.4404	-40...70	PE (polyethylene)	15	E20750













Acrylic fibre optics for OBF / OOF housings, through-beam system, highly flexible

Type	System	Fibre optic material	Range OB50.. / OBF5.. / OO50.. [mm]	Sensing head material	Ambient temperature [°C]	Sheathing material	Drawing no.	Order no.
	FE-11	PMMA	50 / 56 / 120	aluminium	-40...60	PE (polyethylene)	8	E21103
	FE-11	PMMA	50 / 56 / 120	aluminium	-40...60	PE (polyethylene)	9	E21104
	FE-11	PMMA	250 / 350 / 750	aluminium	-40...60	PE (polyethylene)	9	E21102



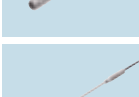

Position sensors

Acrylic fibre optics for OBF / OOF housings, diffuse reflection system

Type	System	Fibre optic material	Range OB50.. / OBF5.. / OO50.. [mm]	Sensing head material	Ambient temperature [°C]	Sheathing material	Drawing no.	Order no.
	FT-11	PMMA	6 / 10 /	aluminium	-40...70	PE (polyethylene)	16	E20756
	FT-11	PMMA	20 / 25 / 60	aluminium	-40...70	PE (polyethylene)	17	E20639
	FT-11	PMMA	20 / 25 / 60	aluminium	-40...70	PE (polyethylene)	11	E20712
	FT-11	PMMA	60 / 70 / 300	aluminium	-40...70	PE (polyethylene)	18	E20645
	FT-11	PMMA	60 / 90 / 300	aluminium	-40...70	PE (polyethylene)	18	E20651
	FT-11	PMMA	60 / 70 / 300	aluminium	-40...70	PE (polyethylene)	19	E20648
	FT-11	PMMA	60 / 90 / 300	aluminium	-40...70	PE (polyethylene)	19	E20654
	FT-11	PMMA	70 / 100 / 300	aluminium	-40...70	PE (polyethylene)	19	E20633
	FT-11	PMMA	15 / 25 / 60	stainless steel	-40...70	PE (polyethylene)	20	E20748
	FT-11	PMMA	20 / 25 / 60	stainless steel	-40...70	PE (polyethylene)	21	E20711
	FT-11	PMMA	40 / 60 / 150	stainless steel	-40...70	PE (polyethylene)	22	E20715
	FT-11	PMMA	70 / 100 / 300	stainless steel	-40...70	PE (polyethylene)	23	E20749
	FE-11	PMMA	–	–	-30...70	PE (polyethylene)	24	E20772

Acrylic fibre optics for OBF / OOF housings, diffuse reflection system, highly flexible

Type	System	Fibre optic material	Range OB50.. / OBF5.. / OO50.. [mm]	Sensing head material	Ambient temperature [°C]	Sheathing material	Drawing no.	Order no.
	FT-11	PMMA	10 / 10 / 30	aluminium	-40...60	PE (polyethylene)	25	E21106
	FT-11	PMMA	10 / 10 / 30	aluminium	-40...60	PE (polyethylene)	26	E21107
	FT-11	PMMA	70 / 104 / 180	aluminium	-40...60	PE (polyethylene)	27	E21105



Acrylic fibre optics for OBF / OOF housings, through-beam system, can be cut to length

Type	System	Fibre optic material	Range OB50.. / OBF5.. / OO50.. [mm]	Sensing head material	Ambient temperature [°C]	Sheathing material	Drawing no.	Order no.
	FE-11	PMMA	175 / 370 / 700	aluminium	-40...70	–	28	E20767

Acrylic fibre optics for OBF / OOF housings, diffuse reflection system, can be cut to length

Type	System	Fibre optic material	Range OB50.. / OBF5.. / OO50.. [mm]	Sensing head material	Ambient temperature [°C]	Sheathing material	Drawing no.	Order no.
	FT-11	PMMA	55 / 110 / 235	aluminium	-40...70	–	29	E20765

Acrylic fibres on a reel for OBF housing

Type	Description	Order no.
	acrylic fibres on a reel · 20 m · for type OBF, OOF · Housing materials: PE (polyethylene), Fibre optic: PMMA, can be cut to length	E20773
	acrylic fibres on a reel · 50 m · for type OBF, OOF · Housing materials: PE (polyethylene), Fibre optic: PMMA, can be cut to length	E20774



Position sensors

OOF amplifiers for glass fibre optics

Type	Number of input channels	For fibre optics	Type of light	Sensing range through beam	Sensing range diffuse	Output H = light-on D = dark-on	U _b [V]	Drawing no.	Order no.
------	--------------------------	------------------	---------------	----------------------------	-----------------------	---------------------------------------	-----------------------	-------------	-----------

Type OOF · M12 connector · plastics · DC · Wiring diagram no. 1 · Connector groups 14, 16, 17

	2	FE/FT-00	Red	0.4 m	0...200 mm	H/D PNP	12...36	30	OO5004
---	---	----------	-----	-------	------------	---------	---------	----	--------

Type OOF · M12 connector · plastics · DC · Wiring diagram no. 6 · Connector groups 16, 17

	4	FE/FT-00	Red	0.4 m	0...200 mm	H/D PNP	12...36	31	OO5005
---	---	----------	-----	-------	------------	---------	---------	----	--------

Type OOF · M16 connector · plastics · DC · Wiring diagram no. 7 · Connector group 27

	6	FE/FT-00	Red	0.4 m	0...200 mm	H/D PNP	12...36	32	OO5006
---	---	----------	-----	-------	------------	---------	---------	----	--------

Type OOF · M16 connector · plastics · DC · Wiring diagram no. 8 · Connector group 27

	8	FE/FT-00	Red	0.4 m	0...200 mm	H/D PNP	12...36	33	OO5007
---	---	----------	-----	-------	------------	---------	---------	----	--------

OKF amplifiers for glass fibre optics

Type	Number of input channels	For fibre optics	Type of light	Sensing range through beam	Sensing range diffuse	Output H = light-on D = dark-on	U _b [V]	Drawing no.	Order no.
------	--------------------------	------------------	---------------	----------------------------	-----------------------	---------------------------------------	-----------------------	-------------	-----------

Type OKF · Cable 2 m · plastics · DC · Wiring diagram no. 12

	1	FE/FT-00	Red	0...0.12 m	0...40 mm	H/D PNP	10...36	34	OK5001
---	---	----------	-----	------------	-----------	---------	---------	----	--------

Type OKF · M12 connector · plastics · DC · Wiring diagram no. 13 · Connector groups 8, 10, 19, 21, 23, 25, 148, 149, 153, 184, 188, 193, 202

	1	FE/FT-00	Red	0...0.12 m	0...40 mm	H/D PNP	10...36	35	OK5008
---	---	----------	-----	------------	-----------	---------	---------	----	--------

OUF amplifiers for glass fibre optics

Type	Number of input channels	For fibre optics	Type of light	Sensing range through beam	Sensing range diffuse	Output H = light-on D = dark-on	U _b [V]	Drawing no.	Order no.
------	--------------------------	------------------	---------------	----------------------------	-----------------------	---------------------------------------	-----------------------	-------------	-----------

Type OUF · Cable 2 m · plastics · DC · Wiring diagram no. 2

	1	FE/FT-00	Infrared	0.12 m	40 mm	H PNP	10...36	36	OU5001
---	---	----------	----------	--------	-------	-------	---------	----	--------

Type	Number of input channels	For fibre optics	Type of light	Sensing range through beam	Sensing range diffuse	Output H = light-on D = dark-on	U _b [V]	Draw- ing no.	Order no.
------	--------------------------	------------------	---------------	----------------------------	-----------------------	---------------------------------------	-----------------------	------------------	-----------

Type OUF · Cable 2 m · plastics · DC · Wiring diagram no. 3

	1	FE/FT-00	Infrared	0.12 m	40 mm	D PNP	10...36	36	OU5002
---	---	----------	----------	--------	-------	-------	---------	----	---------------







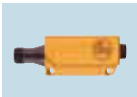

Type OUF · M12 connector · plastics · DC · Wiring diagram no. 4 · Connector groups 8, 10, 11, 18, 19, 21, 23, 25, 148, 149, 150, 153, 154, 184, 188, 190, 193, 202, 203, 204

	1	FE/FT-00	Infrared	0...0.12 m	0...40 mm	H PNP	10...36	37	OU5043
---	---	----------	----------	------------	-----------	-------	---------	----	---------------

Type OUF · M12 connector · plastics · DC · Wiring diagram no. 5 · Connector groups 8, 9, 10, 11, 18, 19, 21, 23, 25, 148, 149, 150, 151, 153, 154, 184, 188, 190, 193, 202, 203, 204

	1	FE/FT-00	Infrared	0...0.12 m	0...40 mm	D PNP	10...36	37	OU5044
---	---	----------	----------	------------	-----------	-------	---------	----	---------------

Glass fibre optics for OOF / OKF and OUF housings, through-beam system

Type	System	Fibre optic material	Range OOF / OKF / OUF [mm]	Sensing head material	Ambient temperature [°C]	Sheathing material	Draw- ing no.	Order no.
	FE-00	glass	400 / 120 / 120	aluminium	-20...80	PVC	38	E20059
	FE-00	glass	400 / 120 / 120	aluminium	-20...80	PVC	39	E20060
	FE-00	glass	400 / 120 / 120	aluminium	-20...80	PVC	40	E20062
	FE-00	glass	400 / 120 / 120	aluminium	-20...80	PVC	41	E20228
	FE-00	glass	160 / 50 / 50	stainless steel	-20...80	PVC	42	E20061
	FE-00	glass	400 / 120 / 120	aluminium	-40...290	aluminium	43	E20128
	FE-00	glass	400 / 120 / 120	aluminium	-40...290	aluminium	44	E20130
	FE-00	glass	400 / 120 / 120	aluminium	-40...290	aluminium	45	E20129
	FE-00	glass	160 / 50 / 50	stainless steel	-40...290	aluminium	46	E20127







Position sensors









Type	System	Fibre optic material	Range OOF / OKF / OUF [mm]	Sensing head material	Ambient temperature [°C]	Sheathing material	Draw- ing no.	Order no.
	FE-00	glass	160 / 50 / 50	stainless steel	-20...150	metal silicone	47	E20506
	FE-00	glass	400 / 120 / 120	stainless steel	-20...150	metal silicone	48	E20505
	FE-00	glass	400 / 120 / 120	stainless steel	-20...150	metal silicone	49	E20492
	FE-00	glass	400 / 120 / 120	stainless steel	-20...150	metal silicone	50	E20493

Glass fibre optics for OOF / OKF and OUF housings, diffuse reflection system

Type	System	Fibre optic material	Range OOF / OKF / OUF [mm]	Sensing head material	Ambient temperature [°C]	Sheathing material	Draw- ing no.	Order no.
	FT-00	glass	200 / 40 / 40	aluminium	-20...80	PVC	51	E20051
	FT-00	glass	200 / 40 / 40	aluminium	-20...80	PVC	52	E20052
	FT-00	glass	200 / 40 / 40	aluminium	-20...80	PVC	53	E20054
	FT-00	glass	200 / 40 / 40	Brass	-20...80	PVC	54	E20249
	FT-00	glass	24 / 6 / 6	stainless steel	-20...80	PVC	55	E20230
	FT-00	glass	24 / 8 / 8	stainless steel	-20...80	PVC	42	E20053
	FT-00	glass	200 / 40 / 40	aluminium	-40...290	aluminium	56	E20055
	FT-00	glass	200 / 40 / 40	aluminium	-40...290	aluminium	57	E20056
	FT-00	glass	200 / 40 / 40	aluminium	-40...290	aluminium	58	E20058
	FT-00	glass	24 / 8 / 8	stainless steel	-40...290	aluminium	46	E20057

Type	System	Fibre optic material	Range OOF / OKF / OUF [mm]	Sensing head material	Ambient temperature [°C]	Sheathing material	Draw- ing no.	Order no.
	FT-00	glass	24 / 8 / 8	stainless steel	-20...150	metal silicone	47	E20507
	FT-00	glass	200 / 40 / 40	stainless steel	-20...150	metal silicone	59	E20489
	FT-00	glass	200 / 40 / 40	stainless steel	-20...150	metal silicone	60	E20494
	FT-00	glass	200 / 40 / 40	stainless steel	-20...150	metal silicone	53	E20495
	FT-00	glass	- / 40 / 40	Brass	-20...80	-	61	E20078

Accessories

Type	Description	Order no.
	Lens attachment · Ø 5 mm / M3 · for through-beam fibre optics · Housing materials: aluminium black anodised / glass	E20679
	Lens attachment · Ø 6 mm / M4 · for through-beam fibre optics · Housing materials: aluminium black anodised / glass	E20680
	Lens attachment · D5x10-M3-ALU · for through-beam fibre optics · M3 · Housing materials: aluminium black anodised	E20754
	Lens attachment · D5x10-M4-ALU · for through-beam fibre optics · M4 · Housing materials: aluminium black anodised	E20755
	Diaphragm attachment · D5x10-M3-ALU/D0.4 · for through-beam fibre optics · M3 · Housing materials: aluminium black anodised	E20762
	Angle bracket · for type OBF · Housing materials: steel galvanised	E20593
	Angle bracket · OU · with mounting material · Housing materials: galvanised steel	E20211
	Mounting clamp · Ø 3 mm · for fibre optics · Housing materials: aluminium black anodised	E20107
	Mounting clamp · Ø 3.5 mm · for fibre optics · Housing materials: aluminium black anodised	E20106

You can find wiring diagrams and scale drawings from page 308



Position sensors

Type	Description	Order no.
	Mounting clamp · Ø 4.5 mm · for fibre optics · Housing materials: aluminium black anodised	E20105
	Mounting clamp · Ø 5 mm · for fibre optics · Housing materials: aluminium black anodised	E20104
	Mounting clamp · Ø 6 mm · for fibre optics · Housing materials: aluminium black anodised	E20103
	Mounting clamp · Ø 7 mm · for fibre optics · Housing materials: aluminium black anodised	E20102
	Mounting clamp · Ø 8 mm · Housing materials: aluminium black anodised	E10221
	Mounting clamp · Ø 10 mm · for fibre optics · Housing materials: PBT	E20353
	cutter for fibre optics · for type FE/FT-11 · Housing materials: plastics	E20600

Wiring diagrams

Core colours

BK	black
BN	brown
BU	blue
VT	purple
WH	white

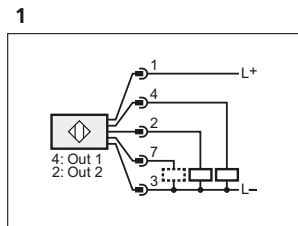

7: function check

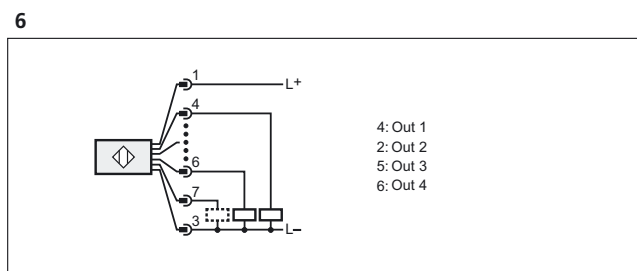
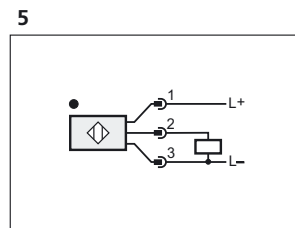
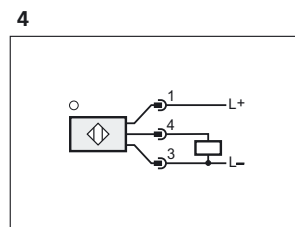
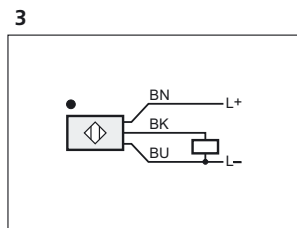
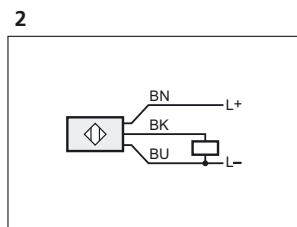

7: function check

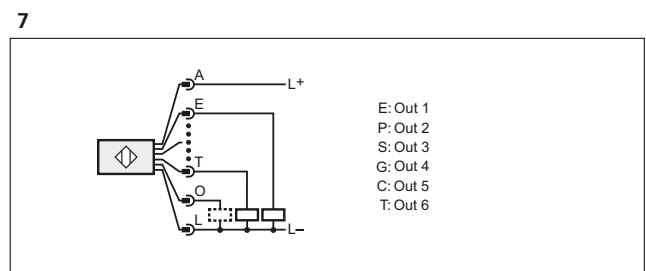

O: function check

Wiring diagrams

8

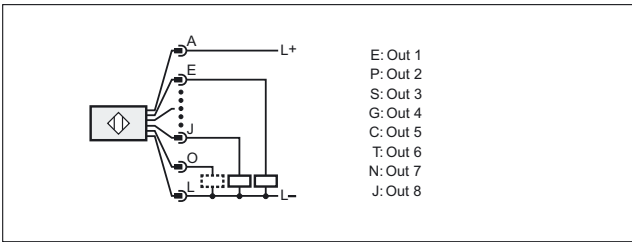

O: function check

9

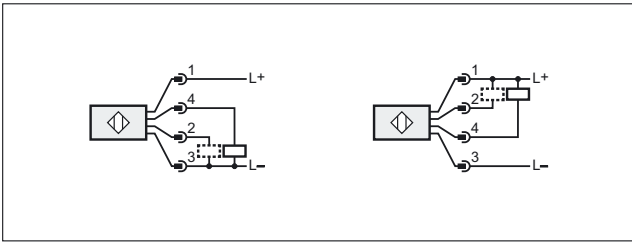

10

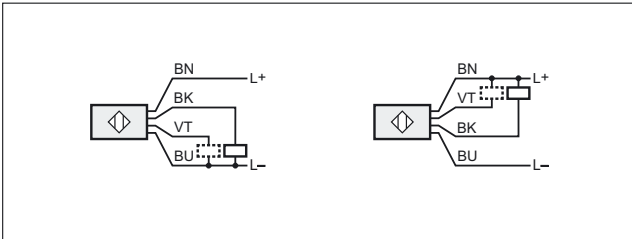

11

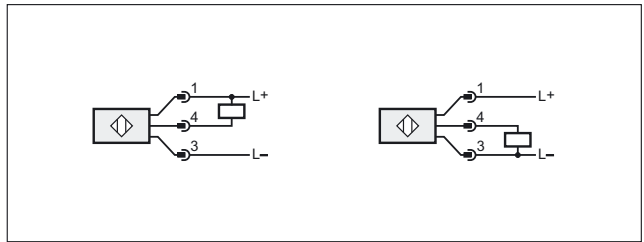

12

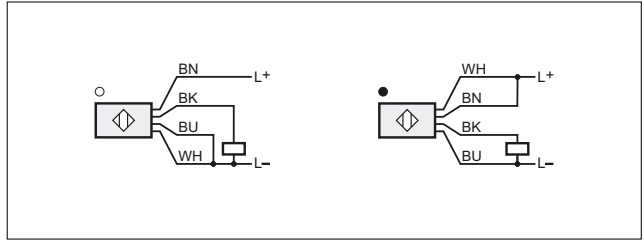

13

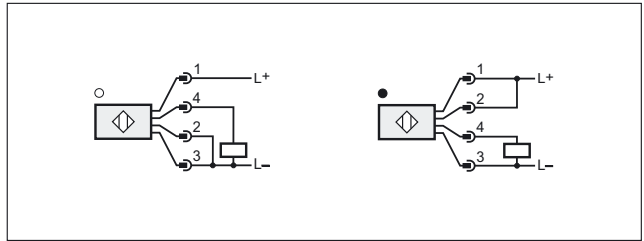

Scale drawings / drawing no. – CAD download: www.ifm.com

1

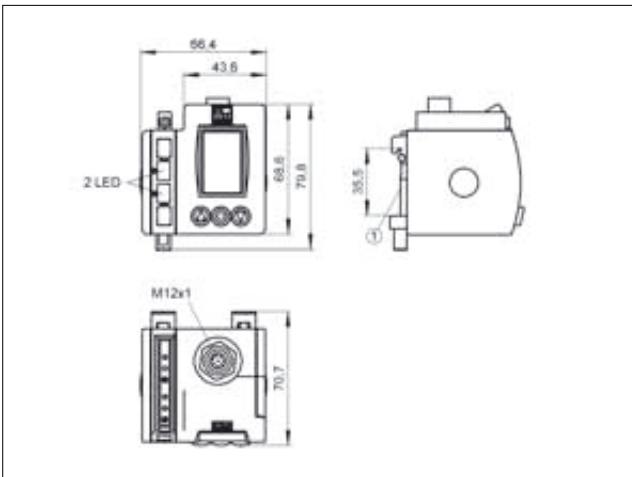

1: Mounting on DIN rail

2

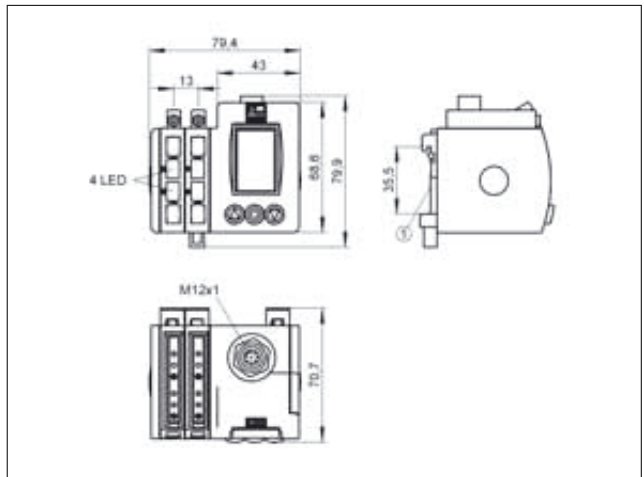

1: Mounting on DIN rail



Position sensors

Scale drawings / drawing no. – CAD download: www.ifm.com

3

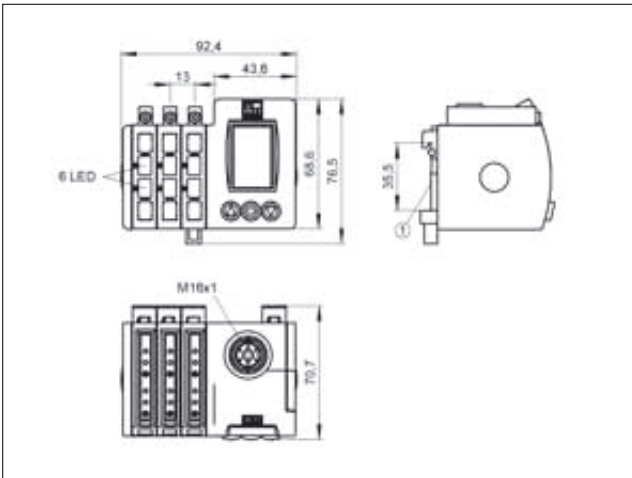

1: Mounting on DIN rail

4

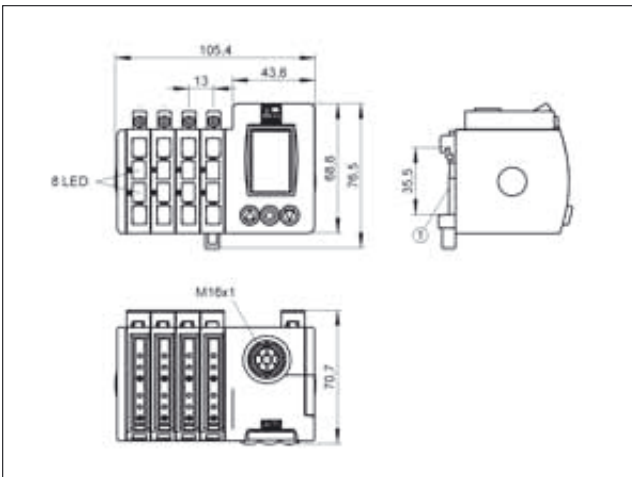

1: Mounting on DIN rail

5

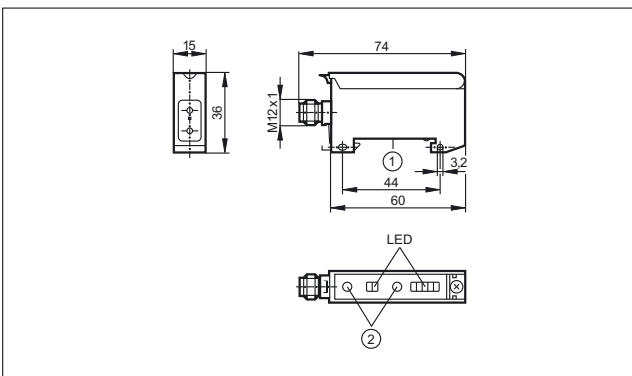

1: Mounting on DIN rail, 2: setting pushbuttons

6

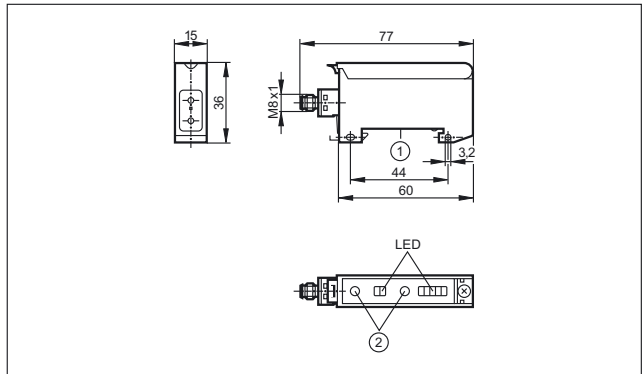

1: Mounting on DIN rail, 2: setting pushbuttons

7

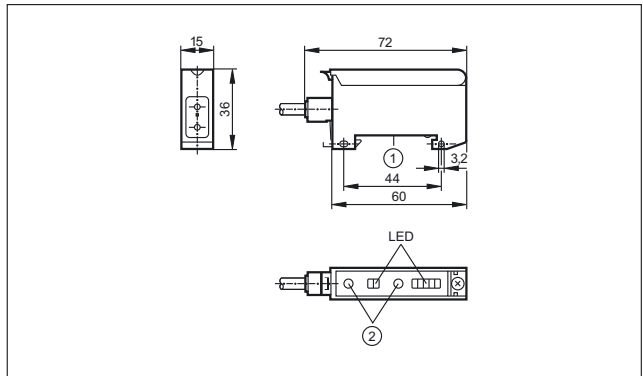

1: Mounting on DIN rail, 2: setting pushbuttons

8

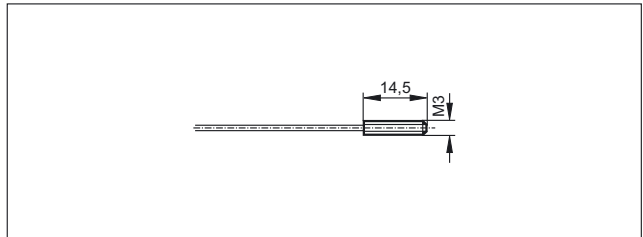

9

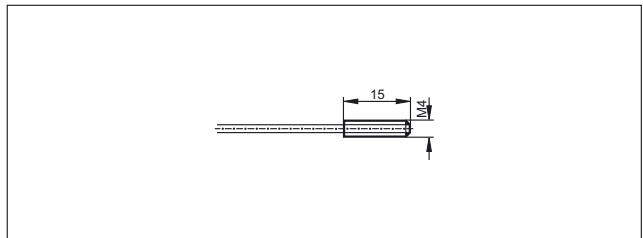

10

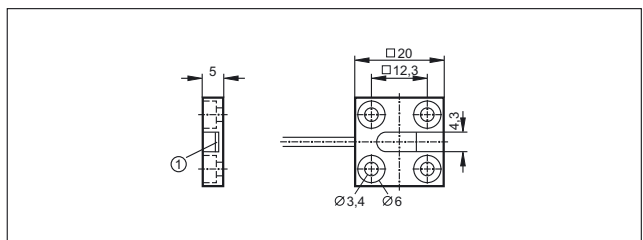

1: Sensing surface

Scale drawings / drawing no. – CAD download: www.ifm.com

11

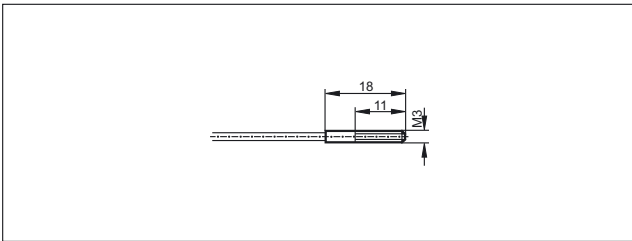

17

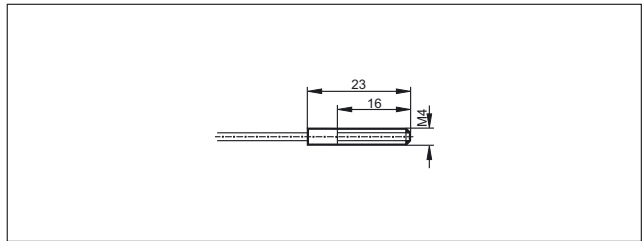

12

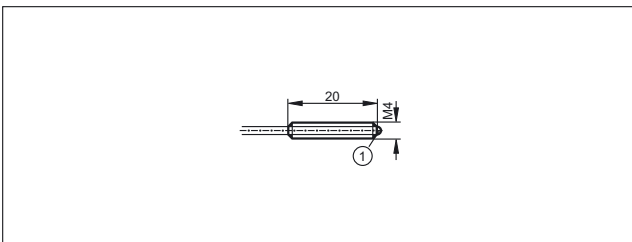

18

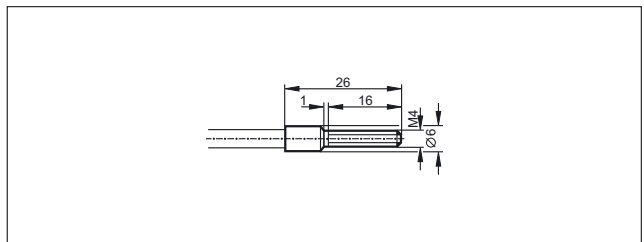

1: glass lens

19

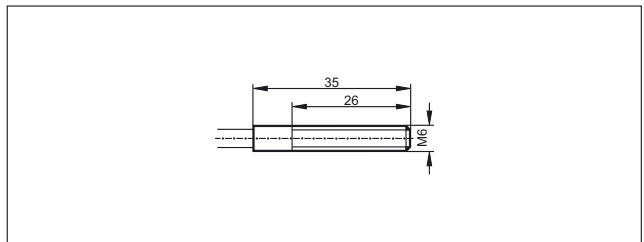

13

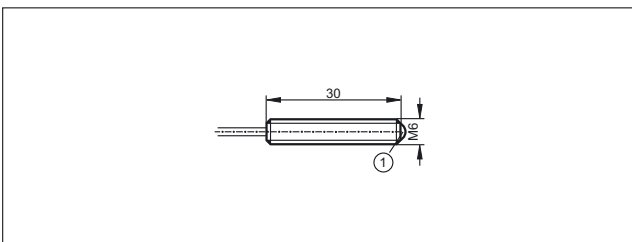

1: glass lens

20

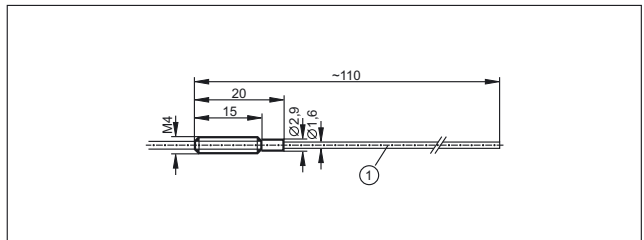

1: bendable

14

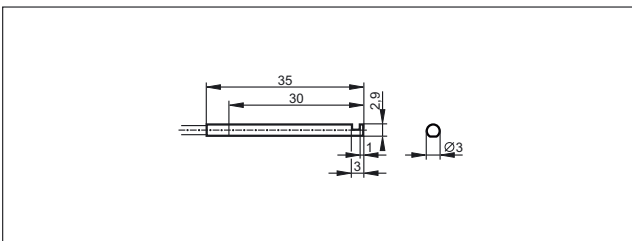

21

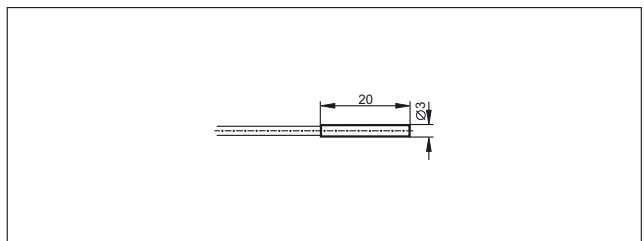

15

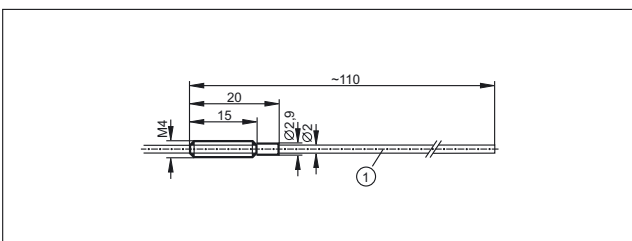

1: bendable

22

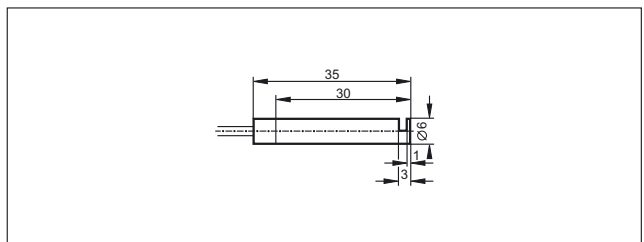

16

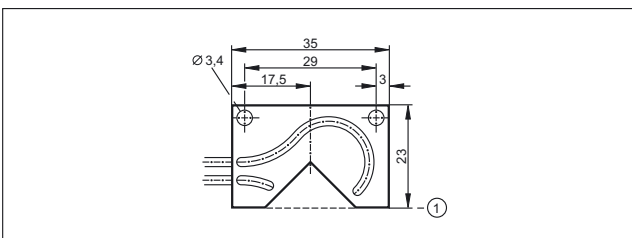

1: Reference edge



Position sensors

Scale drawings / drawing no. – CAD download: www.ifm.com

23

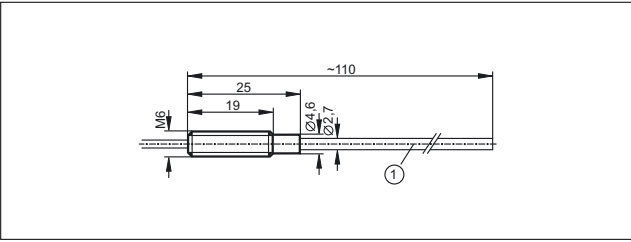

1: bendable

24

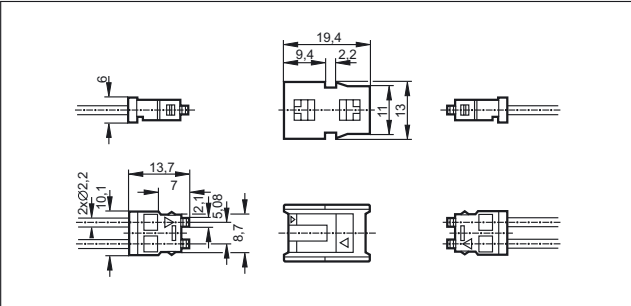

25

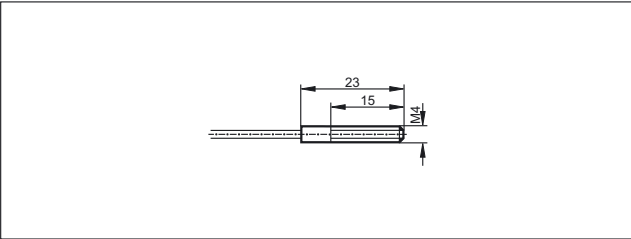

26

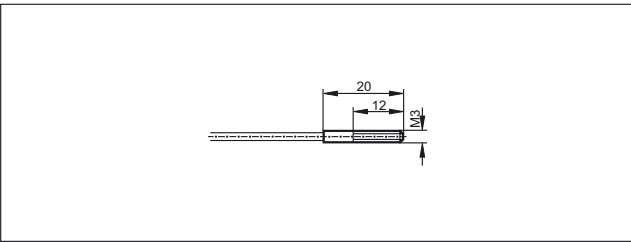

27

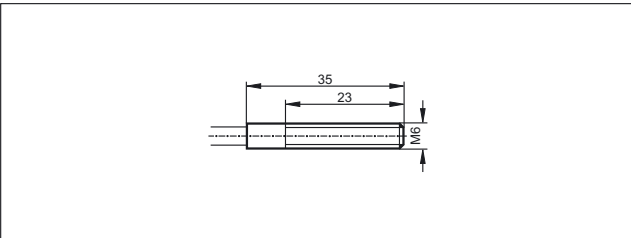

28

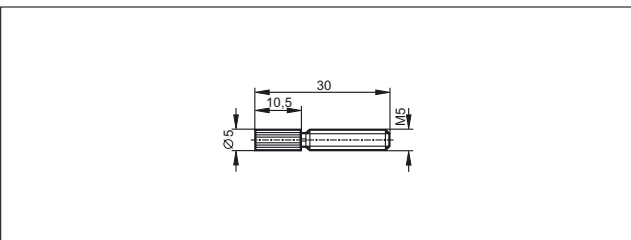

29

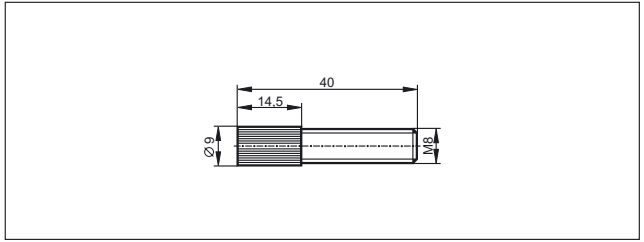

30

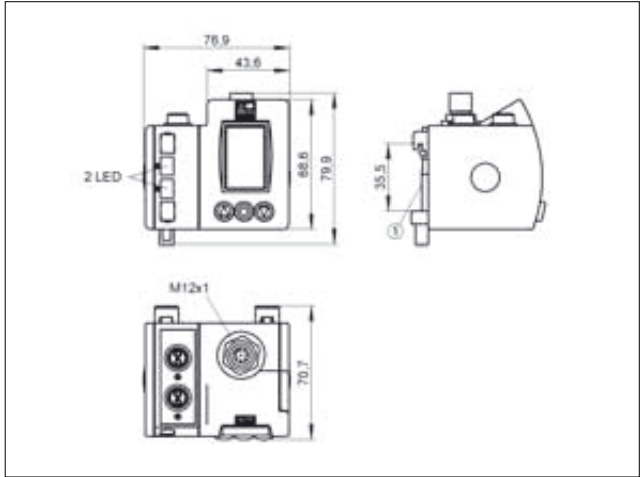

1: Mounting on DIN rail

31

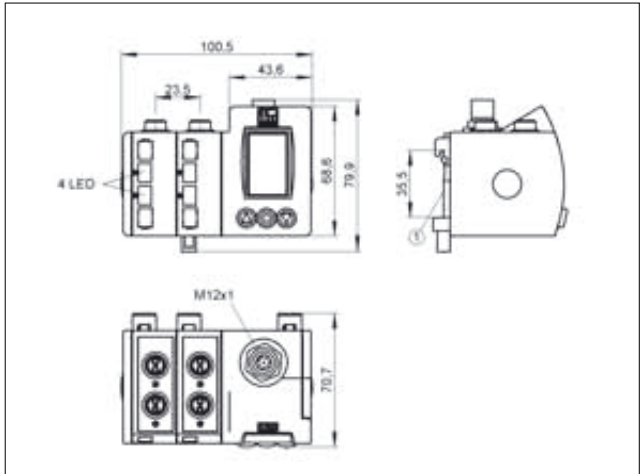

1: Mounting on DIN rail

Scale drawings / drawing no. – CAD download: www.ifm.com

32

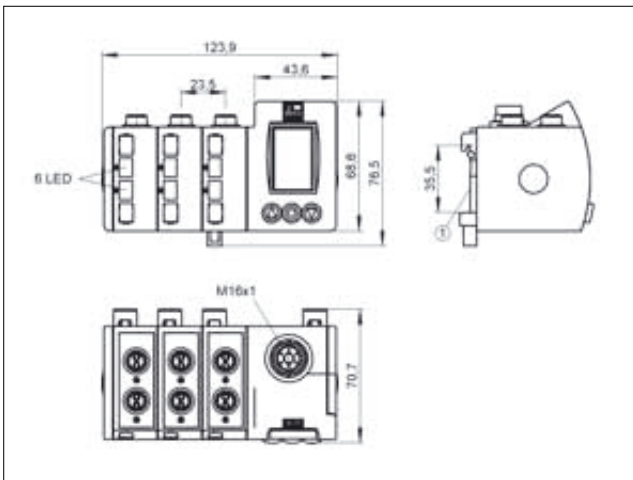

1: Mounting on DIN rail

33

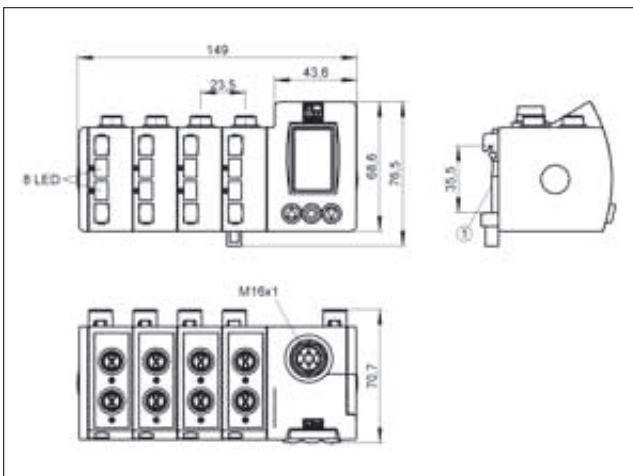

1: Mounting on DIN rail

34

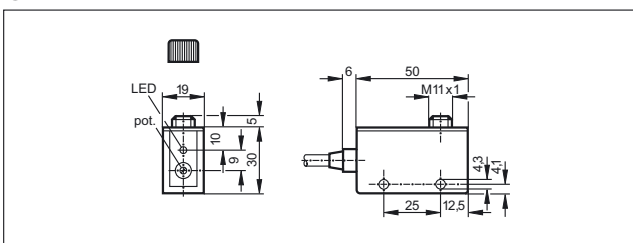

35

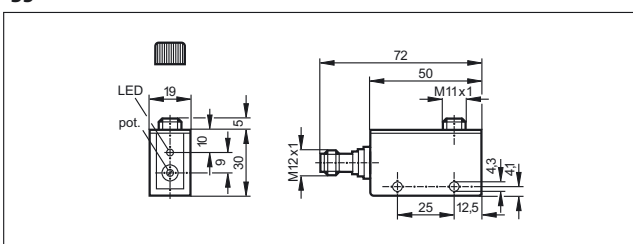

36

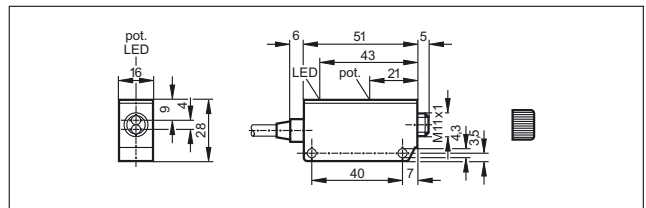

37

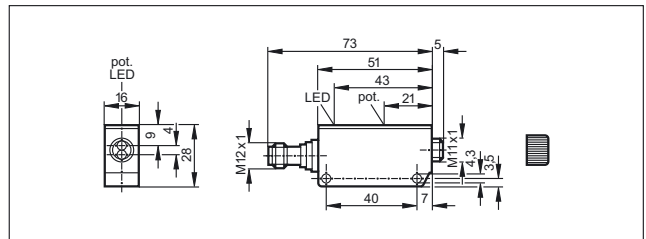

38

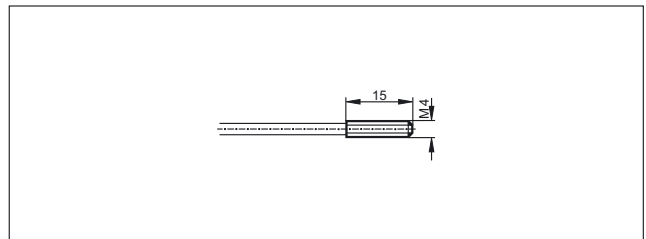

39

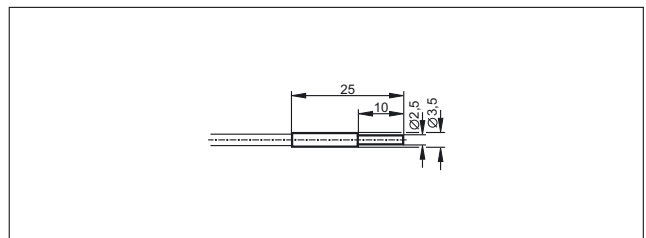

40

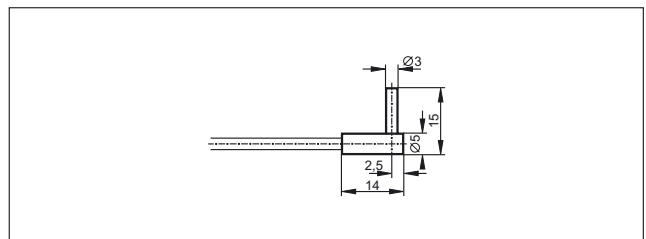

41

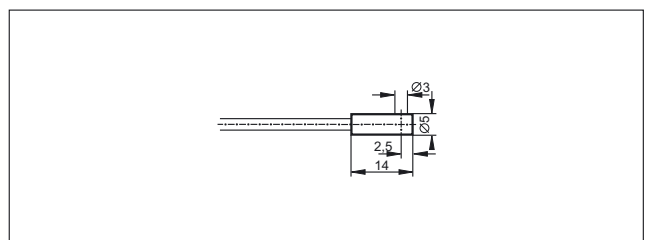



Position sensors

Scale drawings / drawing no. – CAD download: www.ifm.com

42

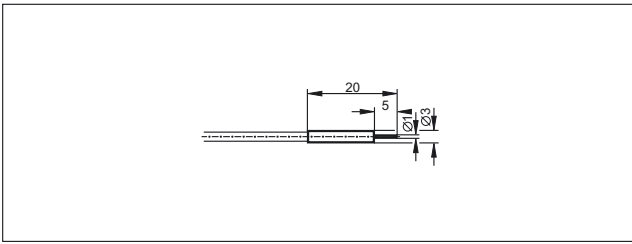

48

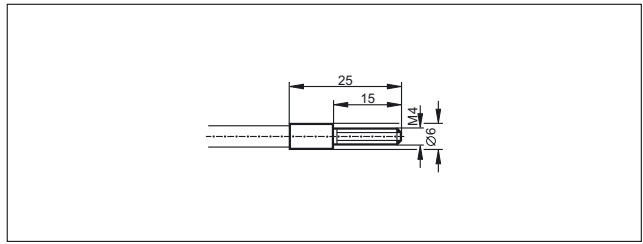

43

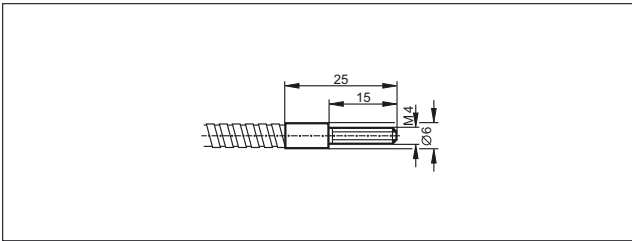

49

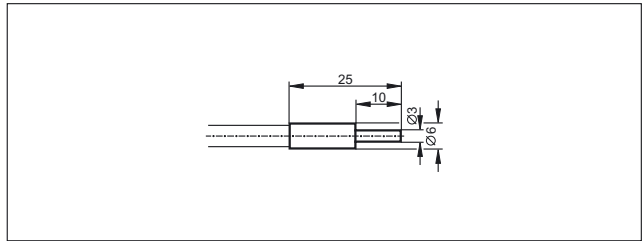

44

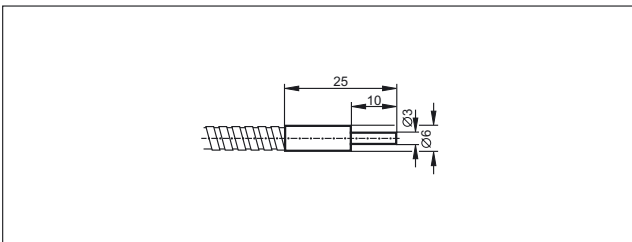

50

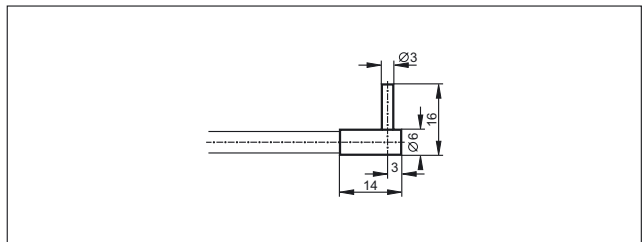

45

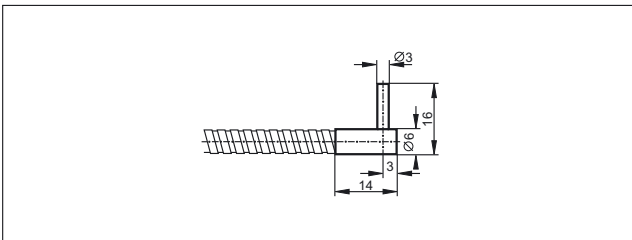

51

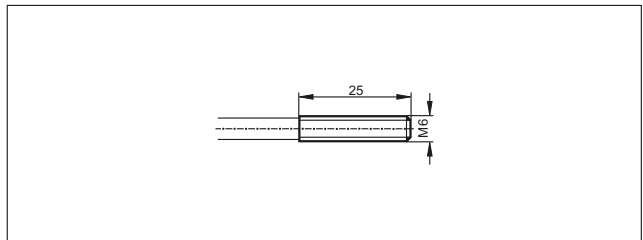

46

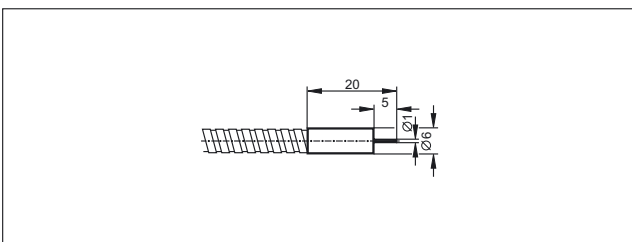

52

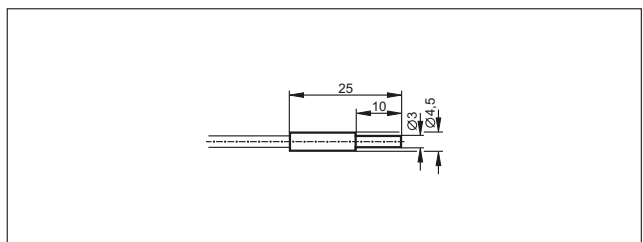

47

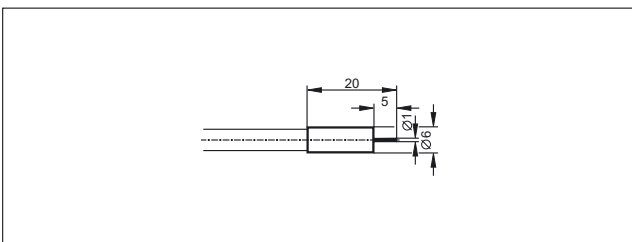

53

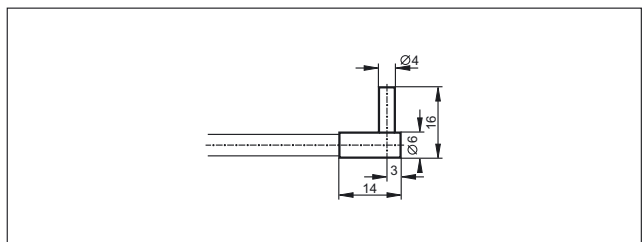

Scale drawings / drawing no. – CAD download: www.ifm.com

54

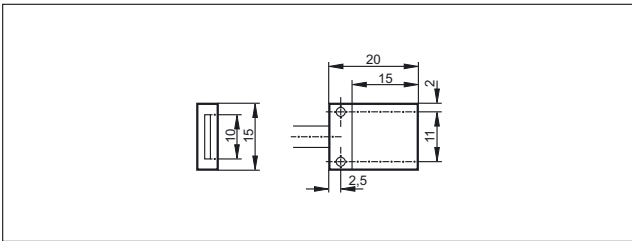

58

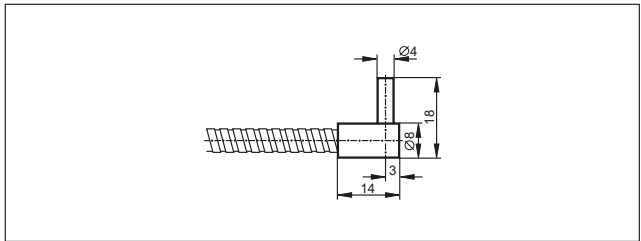

55

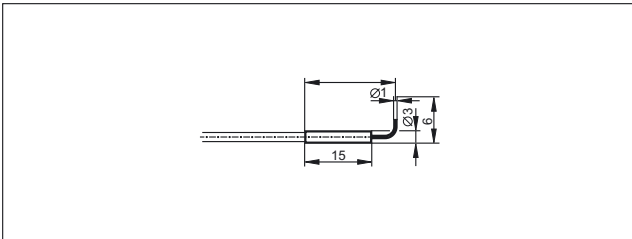

59

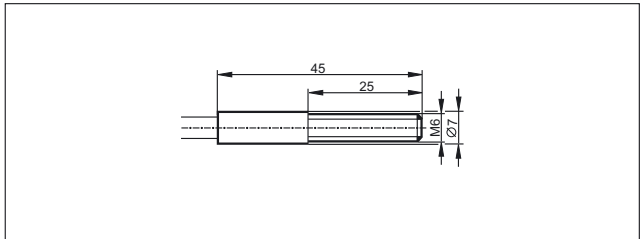

56

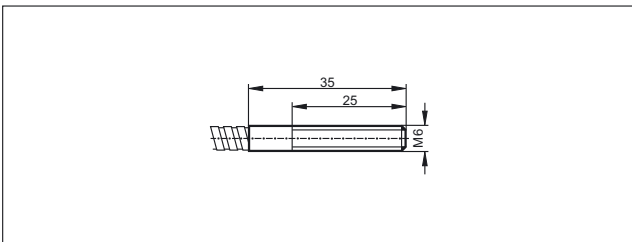

60

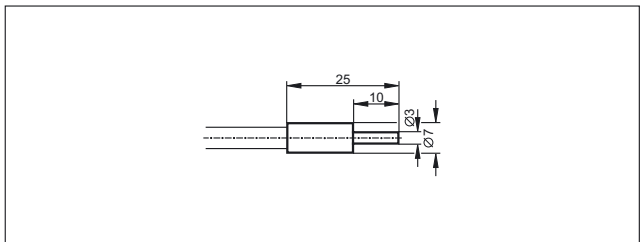

57

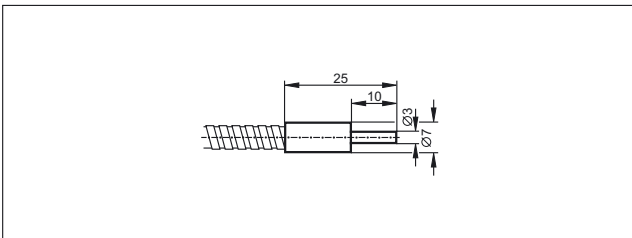

61

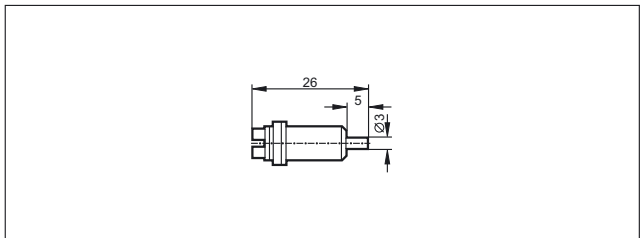



First-class photoelectric systems for flexible use



Photoelectric sensors for specific applications



High-quality photoelectric sensors for different applications

Excellent price / performance ratio

Easy adjustment via teach buttons or potentiometer

Wide range of system components for easy and secure mounting



Detection of transparent objects

ifm offers a retro-reflective sensor with a small switching hysteresis, in particular for the detection of transparent objects.



Contrast sensor

The O5 contrast sensor is particularly suited to detect print marks and very flat objects. With its RGB transmitter LED, the sensor detects even very small differences in contrast.



High-resolution colour sensor

With the five selectable tolerance steps, the colour sensor perfectly differentiates even the finest shades of colour from the background or other objects.

Photoelectric level measurement

Using the time of flight measurement principle, the O1 determines the distance to an object to the nearest millimetre. Installed in the top of a tank, it can detect the level without contact.

System overview	Page
Sensors for the detection of transparent objects	318
Contrast sensors	318
Sensors for colour detection	318
Rectangular housing O1 for optical level measurement, laser class 2	319
Prismatic reflector	319
Accessories OJ housing	319 - 320
Accessories O5 housing	320
Accessories for system components	320 - 321
Wiring diagrams	321
Scale drawings / drawing no. – CAD download: www.ifm.com	322 - 323





Position sensors



Sensors for the detection of transparent objects

Type	Operating principle	Range	Type of light	Spot Ø at max. range [mm]	Output H = light-on D = dark-on	Wiring diagr. no.	Draw- ing no.	Order no.
------	---------------------	-------	---------------	---------------------------	---------------------------------------	-------------------------	---------------------	--------------

Retro-reflective sensor · PVC cable 0.15 m · with M12 connector · 10...30 DC · plastics · IP67 · Connector groups 8, 10, 11, 18, 19, 21, 23, 25, 148, 149, 150, 153, 154, 184, 188, 190, 193, 202, 203, 204

	Polarisation filter	0.2...1.5 m	Red	64	H/D PNP	1	1	OJ5191
	Polarisation filter	0.2...1.5 m	Red	64	H/D PNP	1	2	OJ5190

Retro-reflective sensor · M8 connector · 10...30 DC · plastics · IP67 · Connector groups 4, 5, 80, 86, 147

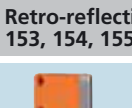
	Polarisation filter	0.2...1.5 m	Red	64	H/D PNP	2	3	OJ5186
	Polarisation filter	0.2...1.5 m	Red	64	H/D NPN	3	3	OJ5189
	Polarisation filter	0.2...1.5 m	Red	64	H/D PNP	2	4	OJ5185

Retro-reflective sensor · M12 connector · 10...36 DC · plastics · IP67 · Connector groups 10, 12, 13, 19, 21, 22, 23, 24, 148, 150, 152, 153, 154, 155, 184, 186, 188, 190, 192, 193, 194, 202, 205

	Polarisation filter	0...3 m	Red	80	H/D PNP/NPN	5	5	O5G500
---	---------------------	---------	-----	----	-------------	---	---	--------

Contrast sensors

Type	Operating principle	Range	Type of light	Spot Ø at max. range [mm]	Output H = light-on D = dark-on	Wiring diagr. no.	Draw- ing no.	Order no.
------	---------------------	-------	---------------	---------------------------	---------------------------------------	-------------------------	---------------------	--------------

M12 connector · 10...36 DC · plastics · IP67 · Connector groups 10, 12, 13, 19, 21, 22, 23, 24, 148, 150, 152, 153, 154, 155, 184, 186, 188, 190, 192, 193, 194, 202, 203, 204, 205

	Diffuse contrast sensor	18...22 mm	RGB	1.5 x 5	H/D PNP/NPN	6	6	O5K500
---	-------------------------	------------	-----	---------	-------------	---	---	--------

Sensors for colour detection

Type	Operating principle	Measuring range	Light spot diameter [mm]	U _b [V]	Current consumption [mA]	Sampling rate / switching frequency [Hz]	Draw- ing no.	Order no.
------	---------------------	--------------------	--------------------------------	-----------------------	--------------------------------	--	---------------------	--------------

M12 connector · Output function light-on / dark-on programmable · DC PNP/NPN · Wiring diagram no. 4 · Connector groups 10, 12, 13, 19, 21, 22, 23, 24, 148, 150, 152, 153, 154, 155, 184, 186, 188, 190, 192, 193, 194, 202, 205

	Colour sensor	15...19 mm	2.5 x 6	10...36	50	2000	6	O5C500
---	---------------	------------	---------	---------	----	------	---	--------

Rectangular housing O1 for optical level measurement, laser class 2

Type	Operating principle	Range	Sampling rate [Hz]	Spot Ø at max. range [mm]	U _b [V]	Wiring diag. no.	Drawing no.	Order no.
------	---------------------	-------	-----------------------	------------------------------	-----------------------	------------------	-------------	-----------

Output function OUT1: normally open / closed programmable OUT2: normally open / closed programmable or analogue (4...20 mA / 0...10 V, scalable) · Wiring diagram no. 7 · Connector groups 8, 10, 19, 21, 23, 25, 148, 149, 153, 184, 188, 193, 202

	Optical level sensor	0.2...10 m	1...33	< 15 x 15	18...30	7	7	O1D300
---	----------------------	------------	--------	-----------	---------	---	---	--------

Prismatic reflector

Type	Description	Order no.
------	-------------	-----------

	Prismatic reflector · 48 x 48 mm · rectangular · for retro-reflective laser sensors and glass and film detection · Housing materials: plastics	E20722
---	--	--------

Accessories OJ housing

Type	Description	Order no.
------	-------------	-----------

	Angle bracket · for type OJ · Housing materials: high-grade stainless steel	E20984
---	---	--------

	Basic clip · OJ · Housing materials: high-grade stainless steel	E20965
---	---	--------

	Basic clip · OJ · Housing materials: diecast zinc	E20964
---	---	--------

	Swivel-mount clip · for type OJ · Housing materials: diecast zinc	E20974
---	---	--------

	Mounting set · OJ · for side lens · Clamp mounting · free-standing M8 · Housing materials: fixture: stainless steel 316Ti / 1.4571 / clamp: diecast zinc	E20968
---	--	--------

	Mounting set · OJ · for side lens · Clamp mounting · free-standing M8 · Housing materials: fixture: stainless steel 316Ti / 1.4571 / clamp: stainless steel	E20969
---	---	--------

	Mounting set · OJ · for side lens · rod mounting Ø 10 mm · Housing materials: clamp: diecast zinc / fixture: stainless steel 316Ti / 1.4571	E21095
---	---	--------

	Mounting set · OJ · for side lens · Clamp mounting · rod mounting Ø 10 mm · Housing materials: fixture: stainless steel 316Ti / 1.4571 / clamp: diecast zinc	E21222
---	--	--------



Position sensors



Type	Description	Order no.
	Mounting set · OJ · for front lens · Clamp mounting · free-standing M8 · Housing materials: clamp: diecast zinc / fixture: stainless steel 316Ti / 1.4571	E20966
	Mounting set · OJ · for front lens · Clamp mounting · rod mounting · Housing materials: fixture: stainless steel 316Ti / 1.4571 / clamp: stainless steel	E21221

Accessories O5 housing

Type	Description	Order no.
	Angle bracket · for type O5 · Housing materials: stainless steel 316Ti / 1.4571	E21085
	Angle bracket · for type O5 · Housing materials: stainless steel 316Ti / 1.4571	E21087
	Mounting set · Clamp mounting · With protective cover · rod mounting Ø 12 mm · for type O5 · Housing materials: fixture: stainless steel 316Ti / 1.4571 / clamp: high-grade stainless steel	E21223
	Mounting set · Clamp mounting · With protective cover · rod mounting Ø 12 mm · for type O5 · Housing materials: stainless steel 316Ti / 1.4571 / clamp: diecast zinc	E21210
	Mounting set · Clamp mounting · rod mounting Ø 12 mm · for type O5, O5D · Housing materials: stainless steel 316Ti / 1.4571 / clamp: diecast zinc	E21211
	Mounting set · Clamp mounting · rod mounting Ø 12 mm · for type O5, O5D · Housing materials: stainless steel 316Ti / 1.4571 / clamp: high-grade stainless steel	E21212
	Mounting brackets Mounting on the back of the unit · for type O5 · Housing materials: stainless steel 316Ti / 1.4571	E21086
	Dovetail clamp · for type DTS, O4, O5 · Housing materials: AlMgSi0.5	E21088

Accessories for system components

Type	Description	Order no.
	mounting rod · Ø 12 / M10 · Length: 130 mm · straight · Housing materials: stainless steel 316Ti / 1.4571	E20938
	mounting rod · Ø 12 / M10 · Length: 200 mm · angled · Housing materials: stainless steel 316Ti / 1.4571	E20940

Type	Description	Order no.
	Head cap screw · M10 x 120 mm · ISO 4762 (DIN 912) · Free-standing M10 · Housing materials: screw: steel galvanised	E21213
	Head cap screw · M10 x 120 mm · ISO 4762 (DIN 912) · Free-standing M10 · Housing materials: screw: high-grade stainless steel	E21214
	Cube · M10 · aluminium profile · Housing materials: diecast zinc	E20951

Wiring diagrams

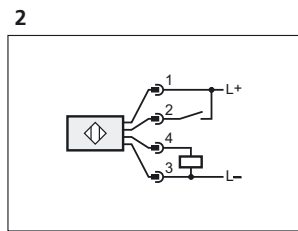
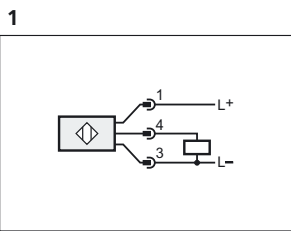

2: Teach

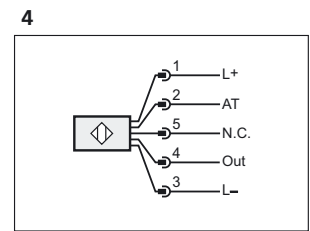
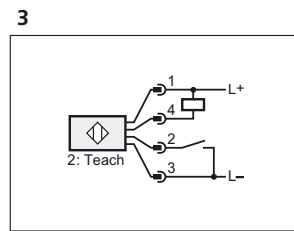

2: Input AT activation trigger, 5: n.c. = not connected

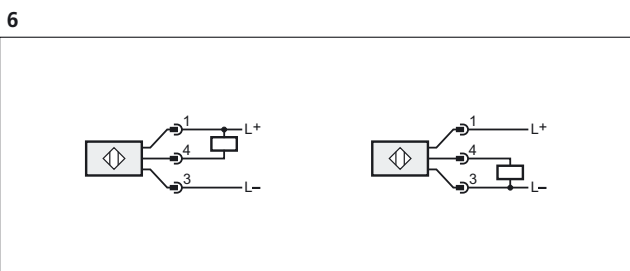
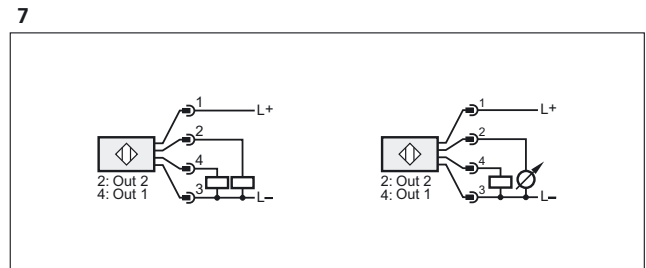
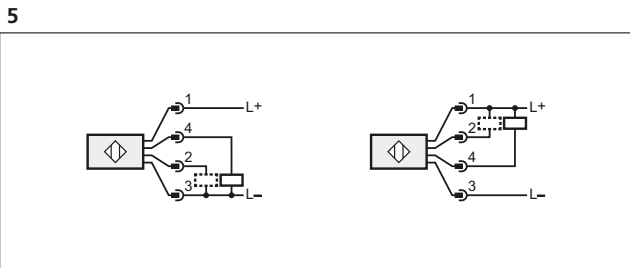



Position sensors

Scale drawings / drawing no. – CAD download: www.ifm.com

1

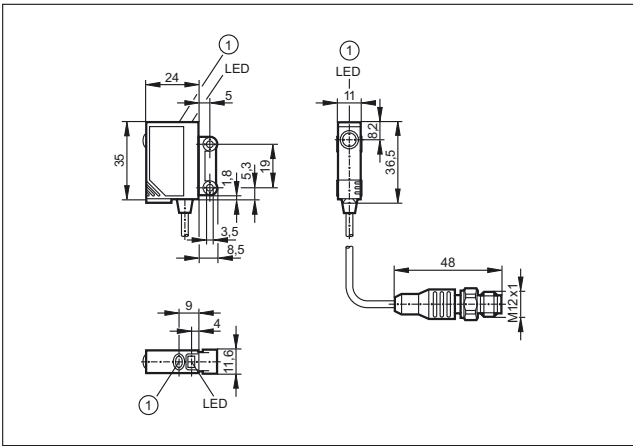

1: pushbutton

4

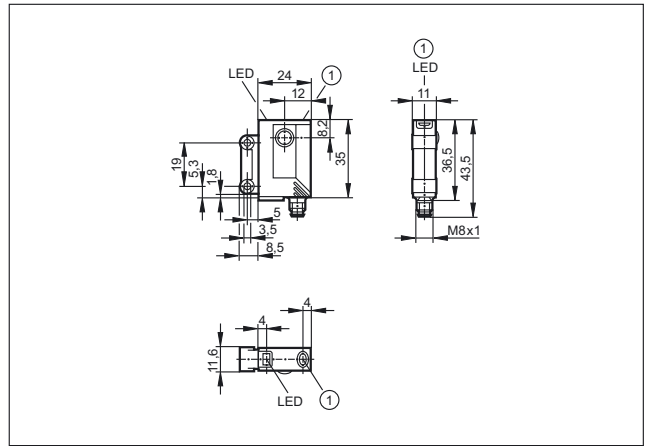

1: pushbutton

2

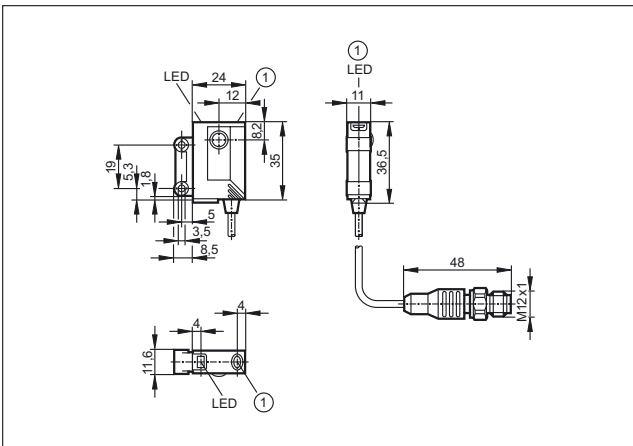

1: pushbutton

5

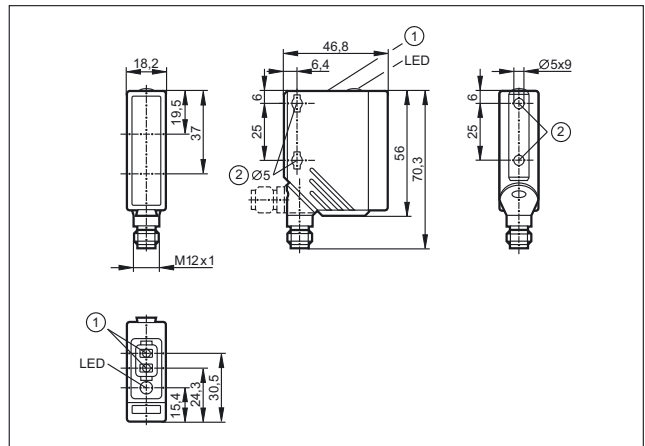

1: Programming buttons, 2: When a M5 mounting screw is used, the max. tightening torque is 2 Nm.

3

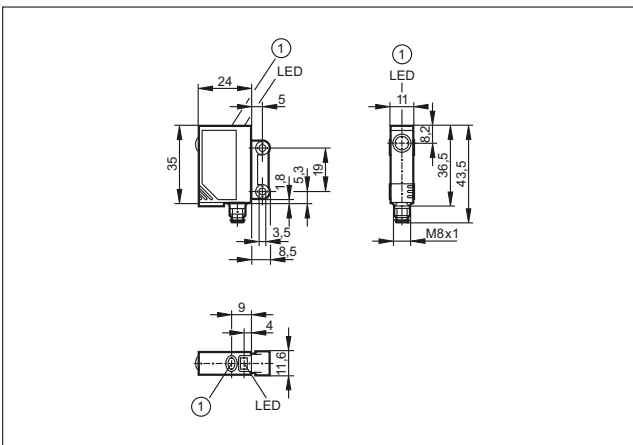

1: pushbutton

6

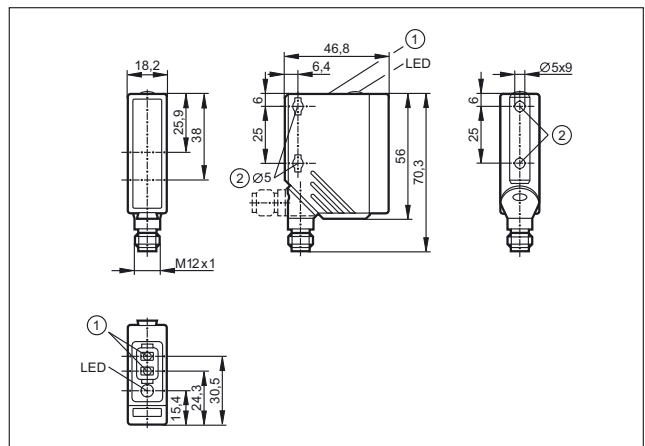

1: Programming buttons, 2: When a M5 mounting screw is used, the max. tightening torque is 2 Nm.

Scale drawings / drawing no. – CAD download: www.ifm.com

7

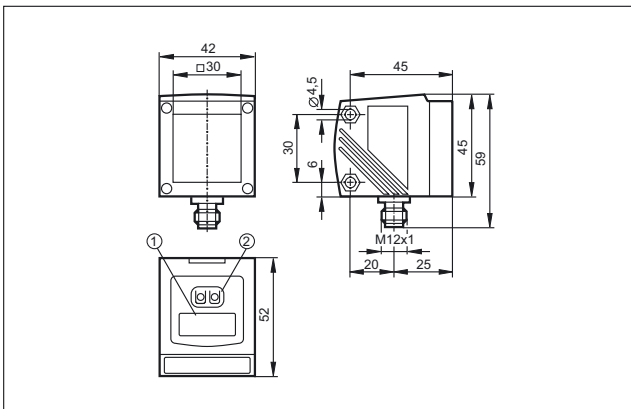

1: 4-digit alphanumeric display, 2: Programming buttons



Reliable valve position monitoring



Feedback systems for valves and valve actuators



Dual inductive feedback sensors for pneumatic actuators and valves

Designed for simple fit to common actuators based on VDI / VDE 3845

AS-i valve sensor for quick and safe „plug & play“ installation

Position feedback for rising stem valves up to 80 mm

Permanent valve monitoring for condition-based maintenance

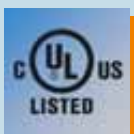
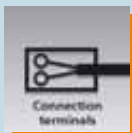

Dual sensor for quarter-turn actuators

A round switching cam, also called "puck", that has at least two metal screws positioned at 90° to each other or a version that is freely adjustable to any angle is mounted to the actuator shaft. The screws are located at a different height. Two inductive sensors detect the upper or lower metal screw depending on the valve position and thus the two switch positions of the actuator. This system operates reliably with no wear at all. It is resistant to external influence and insensitive to mechanical stress such as vibration and shock.

Sensor for rising stem valves











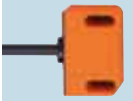



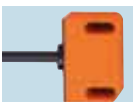

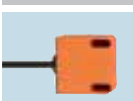

Two or three switch points can be set via pushbuttons over a stroke of 80 mm. Thanks to a resolution of 0.2 mm, the sensor detects even very small changes in the position of the valve. The inductive measuring principle guarantees wear-free non-contact operation.

System overview	Page
Sensors for industrial applications	326 - 327
Sensors for industrial applications, AS-i system	327
Sensors with ATEX approval 1G / 2G and 1D	328
Sensors with ATEX approval 3D and / or 3G	328 - 329
Sensors for rising stem valves	329
Sensors for rising stem valves, AS-i system	329
Added value packages with Bürkert solenoid valve	330
Added value packages with Norgren Herion solenoid valve	330
Switching cams for sensors with quarter-turn actuators	330 - 331
Accessories for quarter-turn actuator sensors	331
Accessories for rising stem valve sensors	332
Accessories mounting sets	332
Wiring diagrams	333 - 334
Scale drawings / drawing no. – CAD download: www.ifm.com	334 - 336





Position sensors



Sensors for industrial applications

Type	Dimensions [mm]	Sensing range [mm]	Material	U _b [V]	Protection	f AC / DC [Hz]	I _{load} AC / DC [mA]	Draw- ing no.	Order no.
Cable 2 m · Output function  · DC PNP · Wiring diagram no. 1									
	40 x 26 x 26	4 nf	PBT	10...36	IP 67	1300	250	1	IN5251
Terminals · Output function  · AC/DC · Wiring diagram no. 13									
	33 x 60 x 92	4 nf	PA (polyamide)	20...250	IP 67	25 / 50	350 / 100	2	IN0131*
Cable 6 m · Output function  · DC PNP · Wiring diagram no. 1									
	40 x 26 x 26	4 nf	PC (polycarbonate)	10...36	IP 67	1300	250	1	IN5304
Cable 10 m · Output function  · DC PNP · Wiring diagram no. 1									
	40 x 26 x 26	4 nf	PBT	10...36	IP 67	1300	250	1	IN5323
Cable 2 m · Output function  · AC/DC · Wiring diagram no. 2									
	40 x 26 x 40	4 nf	PBT	20...250	IP 67	25 / 50	250 / 100	3	IN0110*
M12 connector · Output function  · DC PNP/NPN · Wiring diagram no. 14 · Connector groups 8, 10, 19, 21, 23, 25, 148, 149, 153, 184, 188, 193, 202									
	40 x 26 x 26	4 nf	PBT	10...36	IP 67	1300	250	4	IN5224
M12 connector · Output function  · DC PNP/NPN · Wiring diagram no. 3 · Connector groups 8, 10, 19, 21, 23, 25, 148, 149, 153, 184, 188, 193, 202									
	40 x 26 x 47	4 nf	PBT	10...36	IP 67	250	250	5	IN5331
M12 connector · Output function  · DC PNP · Wiring diagram no. 4 · Connector groups 8, 9, 10, 11, 18, 19, 21, 23, 25, 148, 149, 150, 151, 153, 154, 184, 188, 190, 193, 202, 203, 204									
	40 x 26 x 26	4 nf	PBT	10...36	IP 67	1300	250	4	IN5225
	40 x 26 x 47	4 nf	PBT	10...36	IP 67	1300	250	5	IN5327
M18 connector · Output function  · DC PNP · Wiring diagram no. 4 · Connector group 28									
	40 x 26 x 26	4 nf	PBT	10...36	IP 67	1300	250	6	IN5285

Type	Dimensions [mm]	Sensing range [mm]	Material	U _b [V]	Protection	f AC / DC [Hz]	I _{load} AC / DC [mA]	Draw- ing no.	Order no.
------	--------------------	--------------------------	----------	-----------------------	------------	----------------------	--------------------------------------	---------------------	--------------

M18 connector · Output function  /  · AC/DC · Wiring diagram no. 5 · Connector group 28

	40 x 26 x 40	4 nf	PBT	20...250	IP 67	25 / 50	250 / 100	7	IN0108*
---	--------------	------	-----	----------	-------	---------	-----------	---	---------

Rd 24 x 1/8 connector 6 pins · Output function  /  · DC PNP · Connector groups 38, 44, 159, 160

	40 x 26 x 60	4 nf	PBT	10...36	IP 67	1300	250	8	IN5334
---	--------------	------	-----	---------	-------	------	-----	---	--------

Terminals · Output function  /  · DC PNP · Wiring diagram no. 15

	33 x 60 x 92	4 nf	PA (polyamide)	10...30	IP 67	500	100	2	IN5409
---	--------------	------	----------------	---------	-------	-----	-----	---	--------

f = flush / nf = non flush / qf = quasi-flush

*** Note on use of miniature fuses for electrical connection**

Miniature fuse to IEC60127-2 sheet 1, ≤ 2 A (fast acting) Recommendation: check the unit for reliable function after a short circuit.

Sensors for industrial applications, AS-i system

Type	Dimensions [mm]	Sensing range [mm]	Material	U _b [V]	Protection	f AC / DC [Hz]	I _{load} AC / DC [mA]	Draw- ing no.	Order no.
------	--------------------	--------------------------	----------	-----------------------	------------	----------------------	--------------------------------------	---------------------	--------------

M12 connector · AS-i · Wiring diagram no. 6 · Connector groups 10, 12, 13, 19, 21, 22, 23, 24, 148, 152, 153, 155, 184, 186, 188, 192, 193, 194, 202, 205

	55 x 60 x 35	4 nf	PBT (Pocan)	26.5...31.6	IP 67	–	–	9	AC2315
---	--------------	------	-------------	-------------	-------	---	---	---	--------

M12 connector · Output function transistor PNP · AS-i · Wiring diagram no. 6 · Connector groups 8, 10, 19, 21, 23, 25, 44, 148, 149, 153, 159, 160, 184, 188, 193, 202

	55 x 60 x 35	4 nf	PBT (Pocan)	26.5...31.6	IP 67	–	100	10	AC2316
---	--------------	------	-------------	-------------	-------	---	-----	----	--------

M12 connector · Output function transistor PNP · 2 inputs / 2 outputs · Connector groups 8, 10, 19, 21, 23, 25, 44, 148, 149, 153, 159, 160, 184, 188, 193, 202

	55 x 60 x 35	4 nf	PBT (Pocan)	26.5...31.6	IP 67	–	–	10	AC2317
---	--------------	------	-------------	-------------	-------	---	---	----	--------

f = flush / nf = non flush / qf = quasi-flush



Position sensors

Sensors with ATEX approval 1G / 2G and 1D

Type	Dimensions [mm]	Sensing range [mm]	Material	U _{nom.} at 1 KΩ [V]	U _b [V]	Internal capacit. [nF]	Internal inductance [μH]	f [Hz]	Draw- ing no.	Order no.
------	--------------------	--------------------------	----------	-------------------------------------	-----------------------	------------------------------	--------------------------------	-----------	---------------------	--------------

M12 connector · Output function 2 x normally closed · Connection to certified intrinsically safe circuits with the max. values U = 15 V / I = 50 mA / P = 120 mW · Wiring diagram no. 7 · Connector group 195

	40 x 26 x 26	4 nf	PBT	8.2 DC	7.5...15 DC	140	130	1800	11	NN5008
---	--------------	------	-----	--------	-------------	-----	-----	------	----	--------

Cable 2 m · Output function 2 x normally closed · Connection to certified intrinsically safe circuits with the max. values U = 15 V / I = 50 mA / P = 120 mW · Wiring diagram no. 8

	40 x 26 x 26	4 nf	PBT	8.2 DC	7.5...15 DC	140	130	1800	1	NN5009
---	--------------	------	-----	--------	-------------	-----	-----	------	---	--------

Cable 10 m · Output function 2 x normally closed · Connection to certified intrinsically safe circuits with the max. values U = 15 V / I = 50 mA / P = 120 mW · Wiring diagram no. 8

	40 x 26 x 26	4 nf	PBT	8.2 DC	7.5...15 DC	140	140	1800	1	NN5011
---	--------------	------	-----	--------	-------------	-----	-----	------	---	--------

M18 connector · Output function 2 x normally closed · Connection to certified intrinsically safe circuits with the max. values U = 15 V / I = 50 mA / P = 120 mW · Wiring diagram no. 9 · Connector group 28

	40 x 26 x 26	4 nf	PBT	8.2 DC	7.5...15 DC	140	130	1800	6	NN5013
---	--------------	------	-----	--------	-------------	-----	-----	------	---	--------

Terminals · Output function 2 x normally closed · Connection to certified intrinsically safe circuits with the max. values U = 15 V / I = 50 mA / P = 120 mW · Wiring diagram no. 16

	33 x 60 x 92	4 nf	PA (polyamide)	8.2 DC	7.5...15 DC	–	–	500	2	NN504A
---	--------------	------	----------------	--------	-------------	---	---	-----	---	--------

Terminals · Output function 2 x normally closed · Connection to certified intrinsically safe circuits with the max. values U = 15 V / I = 50 mA / P = 120 mW · Wiring diagram no. 17 · Connector group --

	33 x 60 x 92	4 nf	PA (polyamide)	8.2 DC	7.5...15 DC	–	–	500	12	NN505A
---	--------------	------	----------------	--------	-------------	---	---	-----	----	--------

f = flush / nf = non flush / qf = quasi-flush

Sensors with ATEX approval 3D and / or 3G

Type	Dimensions [mm]	Sensing range [mm]	Material	U _b [V]	Protection	f AC / DC [Hz]	I _{load} AC / DC [mA]	Draw- ing no.	Order no.
------	--------------------	--------------------------	----------	-----------------------	------------	----------------------	--------------------------------------	---------------------	--------------

M12 connector · Output function transistor PNP · 2 inputs / 2 outputs · Connector groups 196, 198

	55 x 60 x 35	4	PBT	26.5...31.6	IP 5x	–	–	13	AC327A
---	--------------	---	-----	-------------	-------	---	---	----	--------

M12 connector · Output function transistor PNP · 2 inputs / 1 output · Connector groups 196, 198

	55 x 60 x 35	4	PBT	26.5...31.6	IP 5x	–	–	13	AC336A
---	--------------	---	-----	-------------	-------	---	---	----	--------

Type	Dimensions [mm]	Sensing range [mm]	Material	U _b [V]	Protection	f AC / DC [Hz]	I _{load} AC / DC [mA]	Draw- ing no.	Order no.
------	--------------------	--------------------------	----------	-----------------------	------------	----------------------	--------------------------------------	---------------------	--------------

M12 connector · Output function transistor PNP · 2 inputs / 1 output · Connector groups 196, 198



55 x 60 x 35 4 PBT (Pocan) 26.5...31.6 IP 67 – – 13 AC326A

M12 connector · Output function / · DC PNP · Wiring diagram no. 4 · Connector groups 196, 198



40 x 26 x 47 4 PBT 10...30 IP 67 1300 100 14 IN507A

Cable 2 m · Output function / · DC PNP · Wiring diagram no. 1



40 x 26 x 26 4 PBT 10...30 IP 67 1300 100 15 IN512A

Sensors for rising stem valves

Type	Dimensions [mm]	Sensing range [mm]	Material	U _b [V]	Protection	f AC / DC [Hz]	I _{load} AC / DC [mA]	Draw- ing no.	Order no.
------	--------------------	--------------------------	----------	-----------------------	------------	----------------------	--------------------------------------	---------------------	--------------

Cable 2 m · Output function 1...5 V analogue · DC · Wiring diagram no. 10



67.5 x 43 x 110 – PA 18...36 IP 65 / IP 67 – – 16 IX5002

Cable 2 m · Output function 3 x normally open · DC PNP · Wiring diagram no. 11



67.5 x 43 x 110 – PA 18...36 IP 65 / IP 67 – 100 17 IX5006

Cable with connector 0.3 m · Output function 3 x normally open · DC PNP · Wiring diagram no. 12 · Connector groups 152, 155, 186, 192, 194, 205



65 x 52 x 110 – PA 18...36 IP 65 / IP 67 – 100 18 IX5010



65 x 43 x 110 0.2 PA 18...36 IP 65 / IP 67 – 100 19 ZZ0214

Sensors for rising stem valves, AS-i system

Type	Dimensions [mm]	Sensing range [mm]	Material	U _b [V]	Protection	f AC / DC [Hz]	I _{load} AC / DC [mA]	Draw- ing no.	Order no.
------	--------------------	--------------------------	----------	-----------------------	------------	----------------------	--------------------------------------	---------------------	--------------

Cable with connector 0.15 m · AS-i · Wiring diagram no. 6 · Connector groups 10, 12, 13, 19, 21, 22, 23, 24, 148, 152, 153, 155, 184, 186, 188, 192, 193, 194, 202, 205





65 x 52 x 110 – PA 26.5...31.6 IP 65 / IP 67 – – 18 IX5030





Position sensors





Added value packages with Bürkert solenoid valve

Type	Description	Order no.
	Added value package AS-i for pneumatic quarter-turn actuators · A/B slave · Shaft height 20 mm · Hole spacing 80 mm · Connector	AC0017
	Added value package AS-i for pneumatic quarter-turn actuators · A/B slave · Shaft height 30 mm · Hole spacing 80 mm · Connector	AC0019
	Added value package AS-i for pneumatic quarter-turn actuators · A/B slave · Shaft height 30 mm · Hole spacing 130 mm · Connector	AC0020

Added value packages with Norgren Herion solenoid valve

Type	Description	Order no.
	Added value package AS-i for pneumatic quarter-turn actuators · A/B slave · Shaft height 20 mm · Hole spacing 80 mm · Connector	AC0021
	Added value package AS-i for pneumatic quarter-turn actuators · A/B slave · Shaft height 30 mm · Hole spacing 80 mm · Connector	AC0022
	Added value package AS-i for pneumatic quarter-turn actuators · A/B slave · Shaft height 30 mm · Hole spacing 130 mm · Connector	AC0023

Switching cams for sensors with quarter-turn actuators

Type	Description	Order no.
	Target puck · Ø 53 mm · adjustable · Housing materials: Target puck: PA 6 black / Metal parts: stainless steel	E12516
	Target puck · Ø 53 mm · Housing materials: Target puck: PA 6 black / Metal parts: stainless steel	E12517
	Target puck · Ø 55 mm · Inverted function · Housing colour: black · Housing materials: Target puck: PVC / screws: high-grade stainless steel / Metal ring: stainless steel	E17205
	Target puck · Ø 102 mm · adjustable target screws · Housing colour: black · Housing materials: Target puck: PVC / screws: stainless steel 316Ti / 1.4571	E17119
	Target puck · Ø 102 mm · 3 possible switching flag positions · Housing colour: black · Housing materials: Target puck: PA 6 / screws: stainless steel	E17328

Type	Description	Order no.
	Target puck · Ø 102 mm · Housing colour: black · 8 possible switching flag positions · Housing materials: Target puck: PA 6 / screws: stainless steel	E17329
	direction indicator black · 12 x 4.8 · For target puck · Housing materials: POM	E17295
	direction indicator yellow · 12 x 4.8 · For target puck · Housing materials: POM	E17296
	Spacer · Housing materials: PA 6 black / screw: stainless steel	E12526







Accessories for quarter-turn actuator sensors

Type	Description	Order no.
	Spacer · 10 mm · for compensation between target pucks and dual sensor IND · Housing materials: PBT	E10579
	Spacer · 3 mm · for compensation between target pucks and dual sensor IND · Housing materials: PBT	E10584
	Spacer · 5 mm · for compensation between target pucks and dual sensor IND · Housing materials: PBT	E10585
	Cable gland · M20 x 1.5 · Housing materials: PA 6.6	E12208
	Protective cap · M20 x 1.5 · Housing materials: PA 6.6	E12209
	Plug for covering the oblong holes · Housing materials: EPDM	E12212
	reinforcement bracket · for type IND · Housing materials: stainless steel 316Ti / 1.4571	E11310
	protective housing · Accessory for valve sensors · for type IND · Housing materials: stainless steel	E11984
	Mounting kit · MS-MEC-KU-RA--F04A · for ball valve Mecafrance ISO5211/F04 DN25 PN40 · Detection of the "ON/OFF" position by means of the IND dual sensor	E10597



Position sensors

Accessories for rising stem valve sensors

Type	Description	Order no.
	Mounting adapter · for Alfa Laval valves type SSV (Single Seat Valves) · accessory for IX5010, IX5030 · Housing materials: adapter: PA 6 / target: stainless steel 316L / 1.4404 / screws: stainless steel / clamping device: stainless steel	E12470
	Mounting adapter · for Alfa Laval valves type LKLA-T (Butterfly Valves) · accessory for IX5010, IX5030 · Housing materials: adapter: PA 6 / clamping device: stainless steel / target: stainless steel 316L / 1.4404 / screw: stainless steel / sealing: EPDM	E12476
	Mounting adapter · for SPX/APV valves type single seat valves · accessory for IX5010, IX5030 · Housing materials: flange: high-grade stainless steel / spacer: POM / target: stainless steel 316L / 1.4404	E12515
	Mounting adapter · for SPX/APV valves type butterfly valves · accessory for IX5010, IX5030 · Housing materials: flange: high-grade stainless steel / spacer: POM / target: stainless steel 316L / 1.4404 / sealing: FPM Shore hardness A 80° C	E12501
	Mounting adapter · for GEA single-seat valves · accessory for IX5010, IX5030 · Housing materials: adapter: PA 6 / target: stainless steel 316L / 1.4404	E12478
	Mounting adapter · for Bardiani valves · accessory for IX5010, IX5030 · Housing materials: adapter: PA / target: stainless steel 316L / 1.4404	E12170

Accessories mounting sets

Type	Description	Order no.
	Mounting set · for type IND, INE · Housing materials: Mounting plate: plastics / Metal parts: stainless steel	E12519
	Mounting set · for type IND, INE · Housing materials: Mounting plate: plastics / Metal parts: stainless steel	E12520
	Mounting set · for type IND, INE · Housing materials: Mounting plate: plastics / Metal parts: stainless steel	E12521
	Mounting set · for type IND, INE · Housing materials: Mounting plate: plastics / Metal parts: stainless steel	E12522
	Mounting set · for type IND, INE · Housing materials: Mounting plate: plastics / Metal parts: stainless steel	E12523
	Mounting set · for type IND, INE · Housing materials: Mounting plate: plastics / Metal parts: stainless steel	E12524

Wiring diagrams

Core colours

BN brown
BU blue
BK black
WH white
GY grey

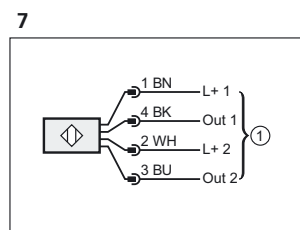
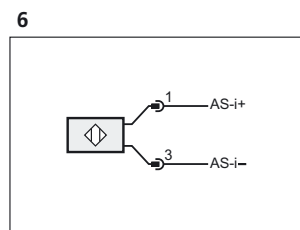
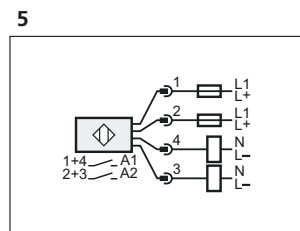
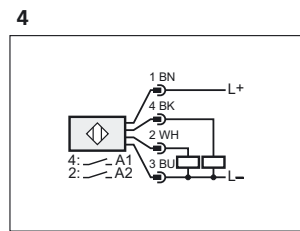
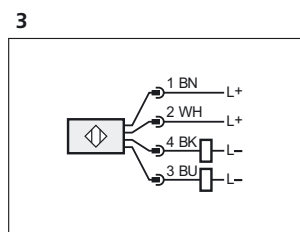
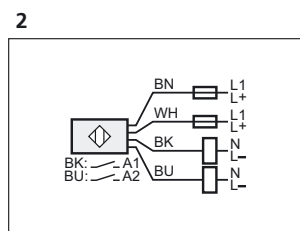
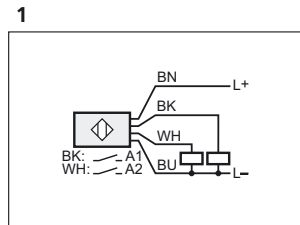

1: connection to NAMUR-amplifier

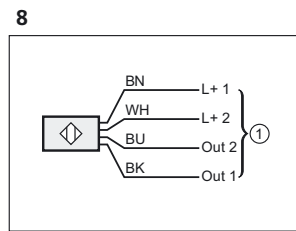

1: connection to NAMUR-amplifier

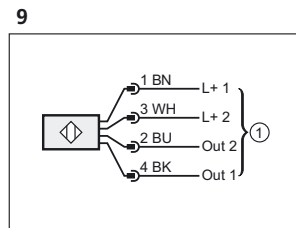

1: connection to NAMUR-amplifier

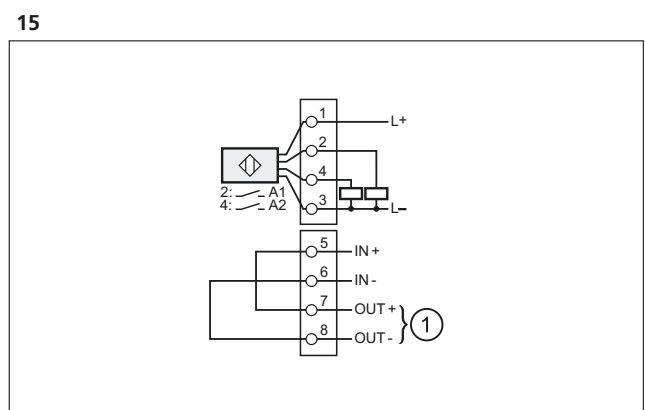
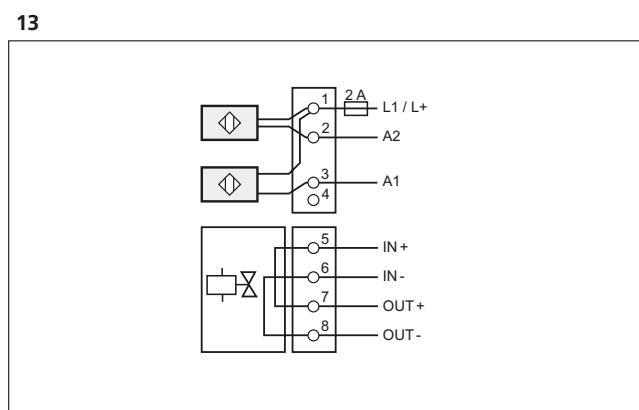
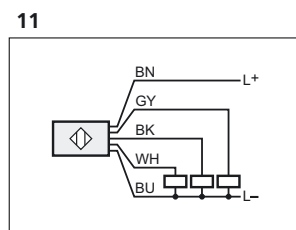
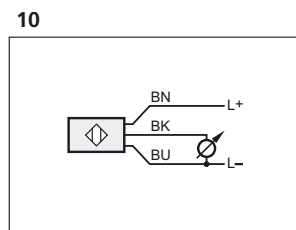

1: solenoid valve

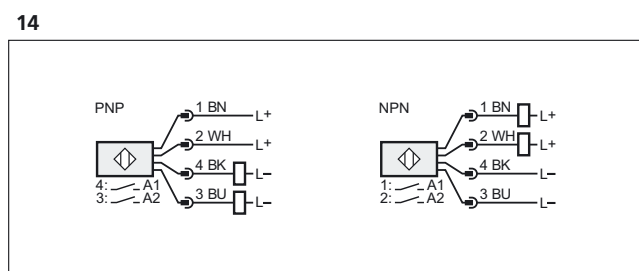



Position sensors

Wiring diagrams

16

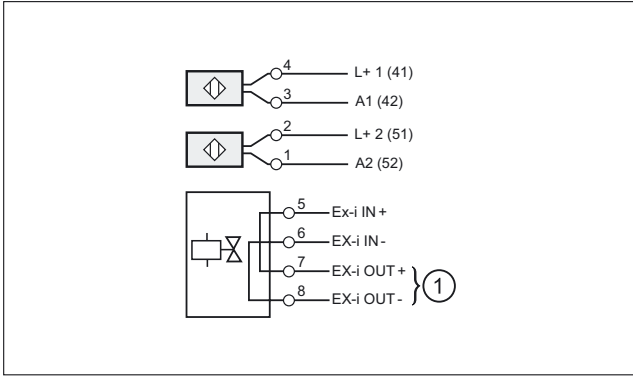

17

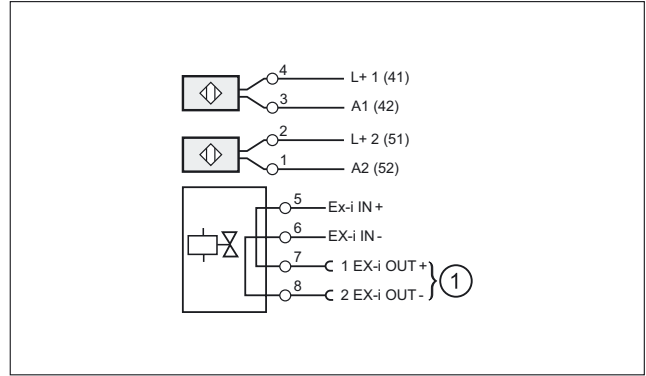

Scale drawings / drawing no. – CAD download: www.ifm.com

1

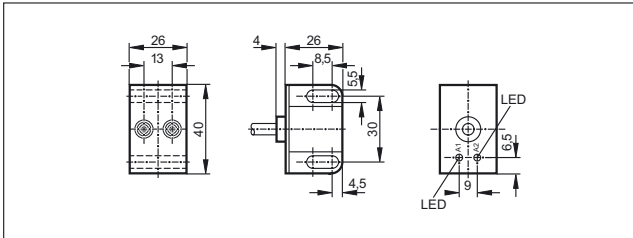

5

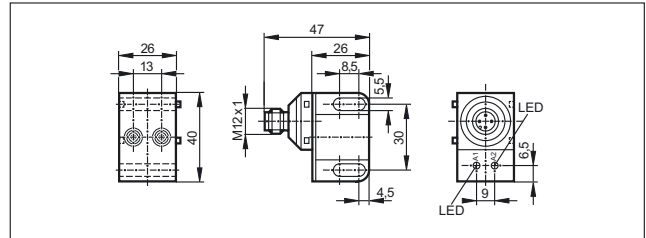

2

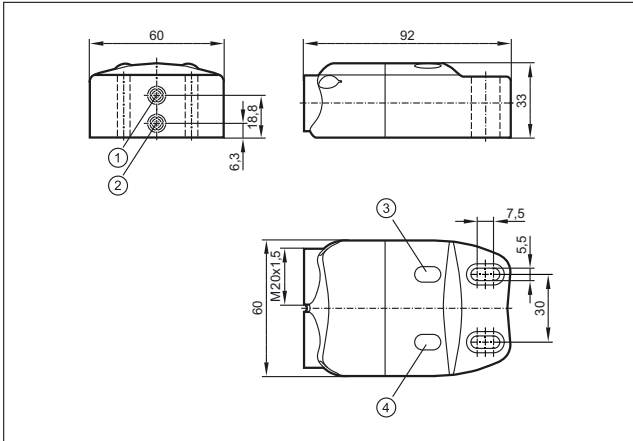

6

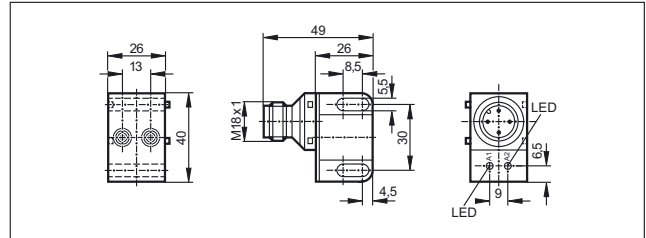

1: sensor 1, 2: sensor 2, 3: LED OUT 2, 4: LED OUT 1

7

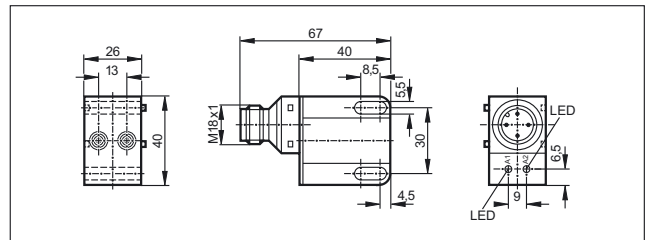

3

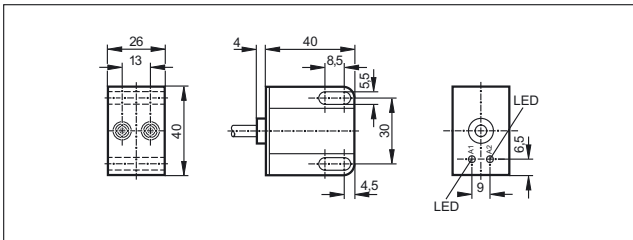

8

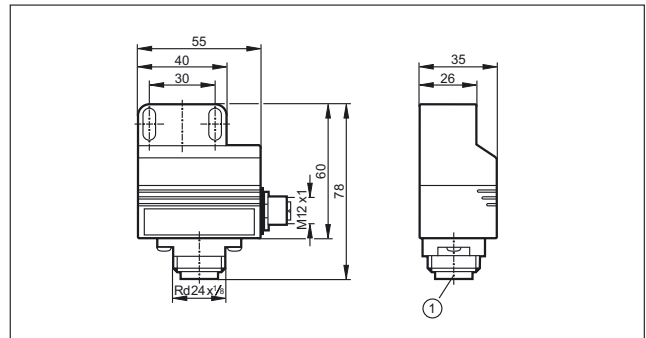

1: field connection

4

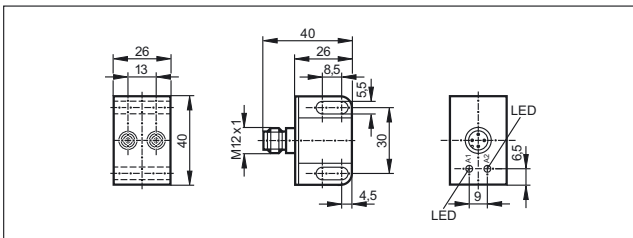

Scale drawings / drawing no. – CAD download: www.ifm.com

9

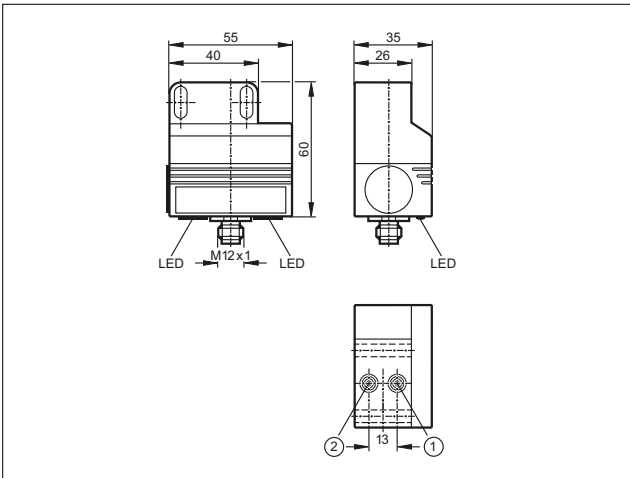

1: sensor 1, 2: sensor 2

10

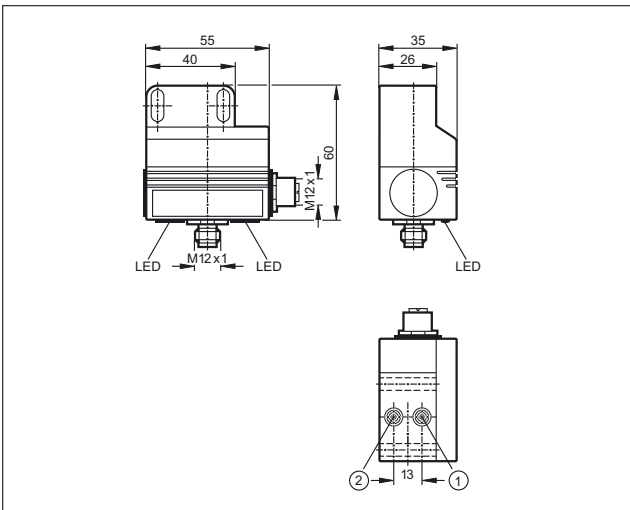

1: sensor 1, 2: sensor 2

11

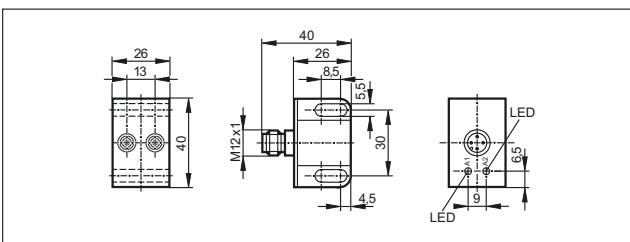

12

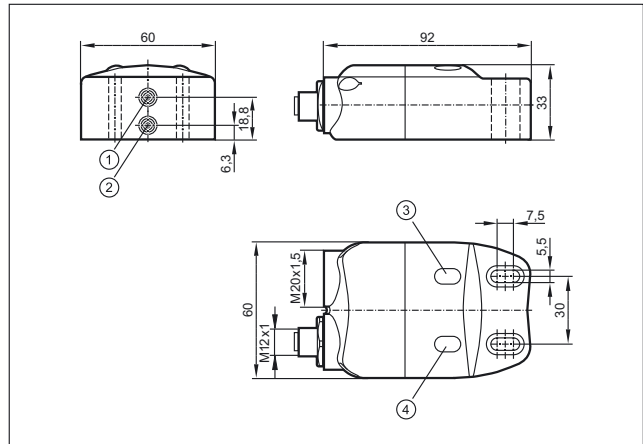

1: sensor 1, 2: sensor 2, 3: LED OUT 2, 4: LED OUT 1

13

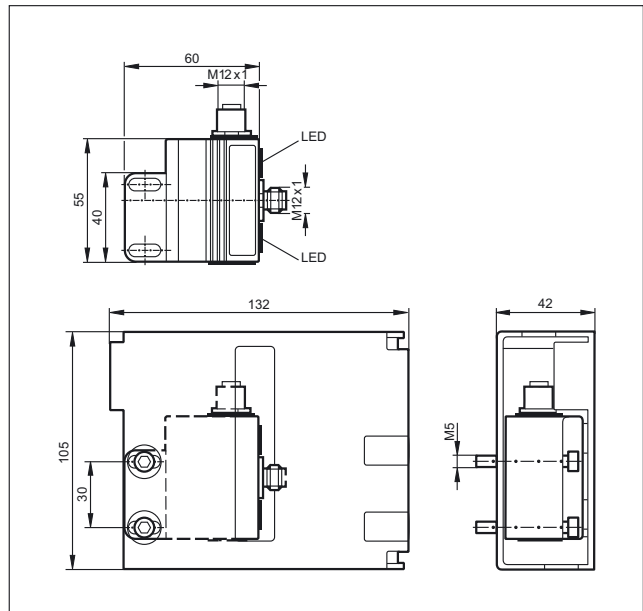

14

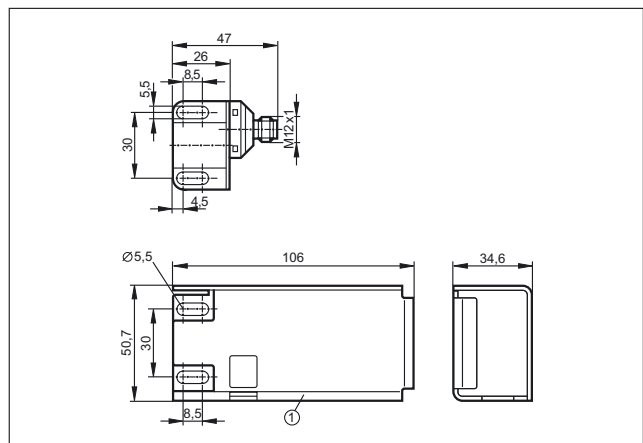

1: protective housing



Position sensors

Scale drawings / drawing no. – CAD download: www.ifm.com

15

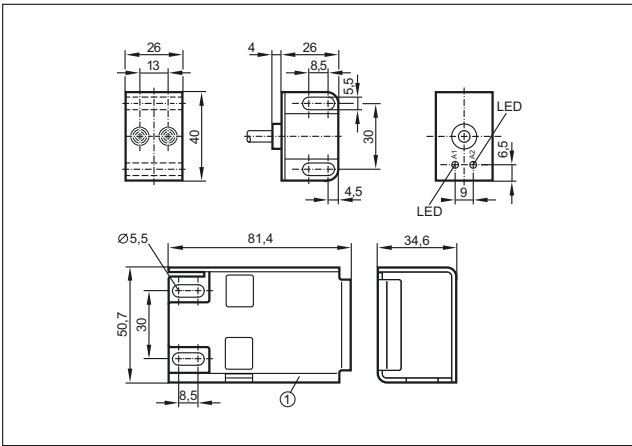

16

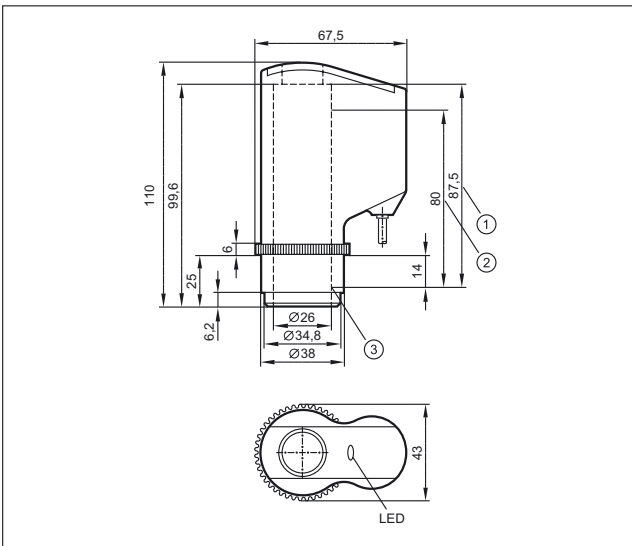

1: Max. spindle stroke, 2: Measuring range, 3: Initial value of the measuring range (zero point)

17

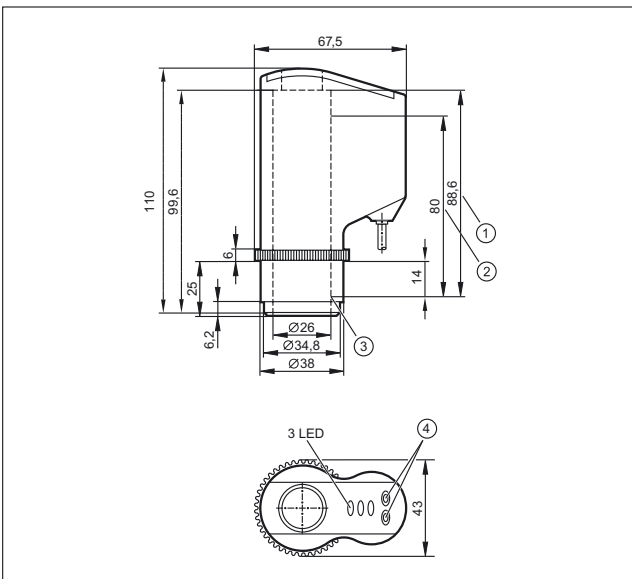

1: Max. spindle stroke, 2: Measuring distance, 3: Initial value of the measuring range (zero point), 4: Programming buttons

18

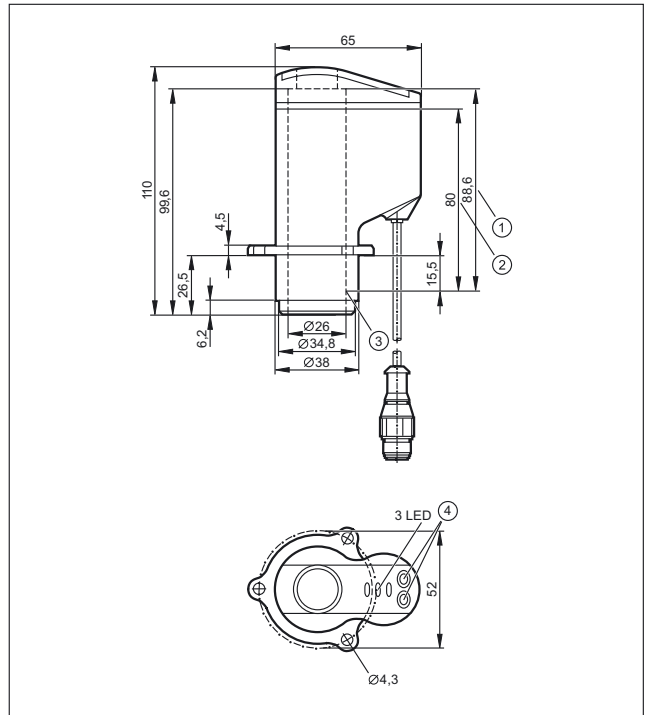

1: Max. spindle stroke, 2: Measuring distance, 3: Initial value of the measuring range (zero point), 4: Programming buttons

19

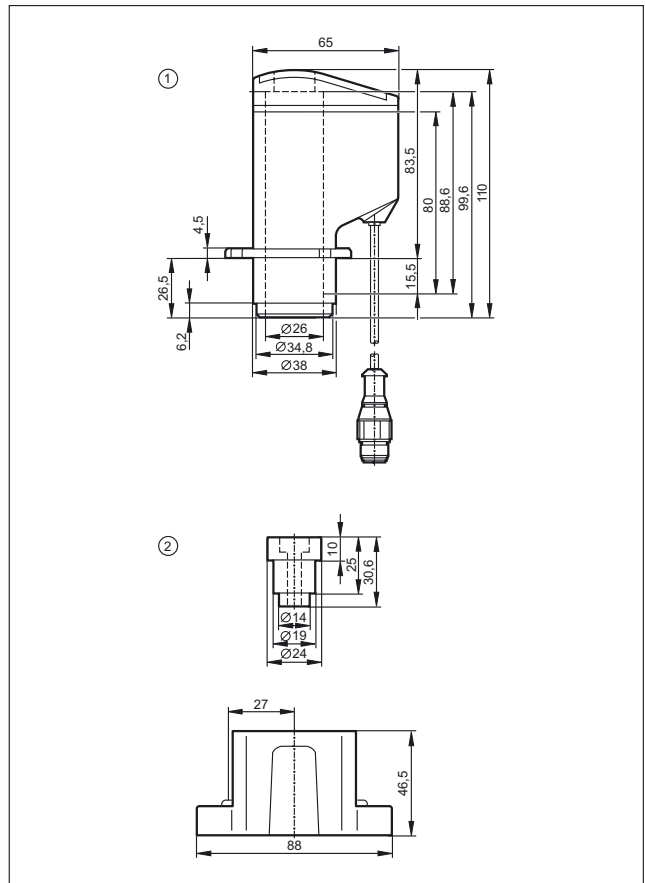

1: Valve sensor IX5010, 2: Mounting adapter E11900





Switching amplifier for converting sensor signals in AC networks



Switching amplifiers



Integrated wide-range power supply for the sensor supply

Small design requiring only very little space

Plug-in screw terminals simplify installation

PNP or NPN control selectable

One or two-channel design



Relay for high load currents

The transistor outputs of conventional sensors are designed for small load currents. If the user wants to switch higher currents or even alternating currents, he must use a switching amplifier.

It uses the sensor signal to control an output relay.

Flexible and space-saving

ifm offers switching amplifiers in one and two-channel design. They have an integrated wide-range power supply (110...240 V AC) to supply the connected sensors with voltage (24 V DC). The new switching amplifiers are distinguished by their slim design so that they only need little space in the control cabinet.

<i>System overview</i>	<i>Page</i>
Switching amplifiers with ATEX approval	340
Scale drawings / drawing no. – CAD download: www.ifm.com	340



Switching amplifiers with ATEX approval

Type	U _b [V]	Power / current consumption [VA] / [mA]	f [Hz]	T _a [°C]	Output	Protection	Drawing no.	Order no.
	115	1.0 /	10	-20...60	relay (1 changeover contact)	IP 20	1	N0030A
	230	1.0 /	10	-20...60	relay (1 changeover contact)	IP 20	1	N0031A
	115	1.3 /	10	-20...60	relay (1 changeover contact per channel)	IP 20	1	N0032A
	230	1.3 /	10	-20...60	relay (1 changeover contact per channel)	IP 20	1	N0033A
	24	/ < 23	10	-20...60	relay (1 changeover contact)	IP 20	1	N0530A
	24	/ < 50	5000	-20...60	2 transistor outputs PNP (100 mA, short-circuit protection)	IP 20	1	N0531A
	24	/ < 50	5000	-20...60	2 outputs (optocoupler, bipolar, 100 mA, short-circuit protection)	IP 20	1	N0532A
	24	/ < 50	10	-20...60	relay (1 changeover contact per channel)	IP 20	1	N0533A
	24	/ < 50	5000	-20...60	2 transistor outputs PNP (100 mA, short-circuit protection)	IP 20	1	N0534A

Scale drawings / drawing no. – CAD download: www.ifm.com

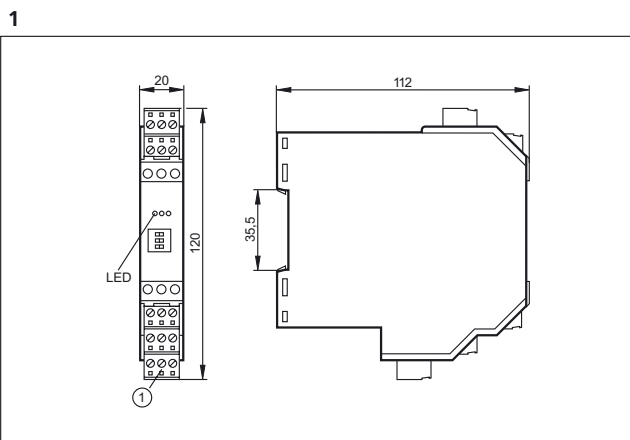

1: Combicon plug with screw terminals (optional)





Accurate linear, angle and rotational speed measurement



Encoders

Encoders convert rotary motion into digital signals. This rotary motion is the result of linear measurements, for example on conveyor belts, or of angle measurements such as those taken by solar tracking systems to optimally align the solar panels towards the sun.

Inclination sensors





Inclination sensors are also used for angle measurement. They are smaller than encoders and easier to install. The core element is a measuring cell for example based on MEMS technology (Micro Electro Mechanical Systems). This measuring method allows evaluation of two axes in one unit. Inclination sensors are therefore a valuable supplement to encoders. They are frequently used in mobile machines (levelling of cranes or fire engines) or in the field of renewable energies.

Speed sensors

Inductive speed sensors with integrated evaluation electronics do not only measure revolutions, but also monitor overspeed and underspeed. Once the sensor has been taught the desired speed, it works completely independently. It relieves users from the additional burden of programming their PLC: they only need to connect the sensor, teach the rotational speed and start the system. If the speed drops below the set value or exceeds it, the sensor sets a binary switching output as a warning.

Systems for pulse evaluation

By using the matching evaluation systems, sensor pulses can be detected, evaluated, compared and converted into different output signals. The user can choose between binary, analogue (4...20 mA and 0...10 V) and PWM output signals.

	Encoders	344 - 357
	Speed sensors	358 - 364
	Inclination sensors	366 - 369
	Pulse evaluation systems	370 - 379



Robust incremental and absolute encoders



Encoders



Robust designs

Industrial standard housings

Cable entry for axial and radial use

Designs with integrated bus interface

Hollow shaft encoders for direct mounting on actuators

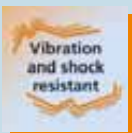

Incremental encoder

They generate a precisely defined number of pulses per revolution. They are a measure of the angular or linear distance moved. The phase difference between the A signal and the B signal, which are shifted by 90 degrees, enables evaluation of the rotational direction.

Absolute encoders

They provide an absolute numerical value for each angular position. Even in the event of a power failure the present position is quickly and reliably detected.

Singleturn and multiturn

Singleturn encoders divide a mechanical revolution into a certain number of measuring steps. The measuring values are repeated after one complete revolution. Multiturn encoders additionally count revolutions.

System overview	Page
Solid shaft encoders, programmable via IO-Link	346
Hollow shaft encoders, programmable via IO-Link	346 - 347
Encoders with display, programmable via IO-Link or pushbuttons	347 - 348
Absolute multiturn encoders (SSI)	348
Absolute singleturn-encoders (Profibus)	348
Absolute multiturn encoders (Profibus)	349
Absolute multiturn encoders (ProfiNet)	349
Absolute singleturn-encoders (CANopen)	349
Absolute multiturn-encoders (CANopen)	350
Fixing accessories for encoders	350
Couplings for encoders	350 - 352
Measuring wheels for encoders	352
Connectors for encoders	352 - 353
Scale drawings / drawing no. – CAD download: www.ifm.com	353 - 357



Solid shaft encoders, programmable via IO-Link

Type	Resolution	U _b [V]	f [kHz]	I _{load} [mA]	Shaft [mm]	Ambient temperature [°C]	Cable entry	Drawing no.	Order no.
------	------------	-----------------------	------------	---------------------------	---------------	-----------------------------	-------------	-------------	-----------

M12 connector · 5-pole · Output function HTL 50 mA (preset at the factory) / TTL 50 mA

	1...10000	4.75...30	1000	50	6	-40...85	radial / axially	1	RB3100
---	-----------	-----------	------	----	---	----------	------------------	---	---------------

Cable 2 m · Output function HTL 50 mA (preset at the factory) / TTL 50 mA

	1...10000	4.75...30	1000	50	6	-40...80	radial / axially	2	RB3500
---	-----------	-----------	------	----	---	----------	------------------	---	---------------

M12 connector · 5-pole · Output function HTL 50 mA (preset at the factory) / TTL 50 mA

	1...10000	4.75...30	1000	50	6	-40...85	radial / axially	3	RU3100
---	-----------	-----------	------	----	---	----------	------------------	---	---------------

Cable 2 m · Output function HTL 50 mA (preset at the factory) / TTL 50 mA

	1...10000	4.75...30	1000	50	6	-40...80	radial / axially	4	RU3500
---	-----------	-----------	------	----	---	----------	------------------	---	---------------

M12 connector · 5-pole · Output function HTL, TTL 50 mA

	1...10000	4.75...30	1000	50	10	-40...85	radial / axially	5	RV3100
---	-----------	-----------	------	----	----	----------	------------------	---	---------------

Cable 2 m · Output function HTL, TTL 50 mA

	1...10000	4.75...30	1000	50	10	-40...80	radial / axially	6	RV3500
---	-----------	-----------	------	----	----	----------	------------------	---	---------------

Hollow shaft encoders, programmable via IO-Link

Type	Resolution	U _b [V]	f [kHz]	I _{load} [mA]	Shaft [mm]	Ambient temperature [°C]	Cable entry	Drawing no.	Order no.
------	------------	-----------------------	------------	---------------------------	---------------	-----------------------------	-------------	-------------	-----------

M12 connector · 5-pole · Output function HTL 50 mA (preset at the factory) / TTL 50 mA

	1...10000	4.75...30	1000	50	6 H7	-40...85	radial / axially	7	RA3100
---	-----------	-----------	------	----	------	----------	------------------	---	---------------



	1...10000	4.75...30	1000	50	6 H7	-40...85	radial / axially	8	RA3101
---	-----------	-----------	------	----	------	----------	------------------	---	---------------

M12 connector · 8 pole · Output function HTL 50 mA (preset at the factory) / TTL 50 mA · Connector groups 16, 17





	1...10000	4.75...30	1000	50	12 H7	-40...85	radial / axially	9	RA3102
---	-----------	-----------	------	----	-------	----------	------------------	---	---------------

Type	Resolution	U _b [V]	f [kHz]	I _{load} [mA]	Shaft [mm]	Ambient temperature [°C]	Cable entry	Drawing no.	Order no.
------	------------	-----------------------	------------	---------------------------	---------------	-----------------------------	-------------	-------------	-----------



Cable 2 m · Output function HTL 50 mA (preset at the factory) / TTL 50 mA

	1...10000	4.75...30	1000	50	6 H7	-40...80	radial / axially	10	RA3500
	1...10000	4.75...30	1000	50	6 H7	-40...80	radial / axially	11	RA3501

M12 connector · 5-pole · Output function HTL 50 mA (preset at the factory) / TTL 50 mA

	1...10000	4.75...30	1000	50	12 F7	-40...85	radial / axially	12	RO3100
	1...10000	4.75...30	1000	50	12 F7	-40...85	radial / axially	13	RO3101
	1...10000	4.75...30	1000	50	15 F7	-40...85	radial / axially	14	RO3102
	1...10000	4.75...30	1000	50	9.525 F7	-40...85	radial / axially	15	RO3103
	1...10000	4.75...30	1000	50	15.875 F7	-40...85	radial / axially	16	RO3104



Cable 2 m · Output function HTL 50 mA (preset at the factory) / TTL 50 mA

	1...10000	4.75...30	1000	50	12 F7	-40...80	radial / axially	17	RO3500
	1...10000	4.75...30	1000	50	12 F7	-40...80	radial / axially	18	RO3501

Encoders with display, programmable via IO-Link or pushbuttons

Type	Resolution	U _b [V]	f [kHz]	I _{load} [mA]	Shaft [mm]	Ambient temperature [°C]	Cable entry	Drawing no.	Order no.
------	------------	-----------------------	------------	---------------------------	---------------	-----------------------------	-------------	-------------	-----------

M12 connector · 8 pole · Output function HTL 50 mA (preset at the factory) / TTL 50 mA · Connector groups 16, 17





	1...10000	4.75...30	1000	50	6	-40...85	radial / axially	19	RUP500
	1...10000	4.75...30	1000	50	10	-40...85	radial / axially	20	RVP510
	1...10000	4.75...30	1000	50	12 F7	-40...85	radial / axially	21	ROP520



Sensors for motion control

Type	Resolution	U _b [V]	f [kHz]	I _{load} [mA]	Shaft [mm]	Ambient temperature [°C]	Cable entry	Drawing no.	Order no.
M12 connector · 8 pole · Output function HTL 50 mA (preset at the factory) / TTL 50 mA · Connector groups 16, 17									
	1...10000	4.75...30	1000	50	12 F7	-40...85	radial / axially	22	ROP521
	1...10000	4.75...30	1000	50	15 F7	-40...85	radial / axially	23	ROP522
	1...10000	4.75...30	1000	50	9.525 F7	-40...85	radial / axially	24	ROP523
	1...10000	4.75...30	1000	50	15.875 F7	-40...85	radial / axially	25	ROP524

Absolute multiturn encoders (SSI)

Type	Resolution	U _b [V]	f [kHz]	I _{load} [mA]	Shaft [mm]	Ambient temperature [°C]	Cable entry	Drawing no.	Order no.
Cable 2 m · Output function SSI data interface									
	4096	4.5...30	–	–	6	-40...85	axial	26	RM8001
	4096	4.5...30	–	–	10	-40...85	axial	27	RM8002
	4096	4.5...30	–	–	12	-40...85	axial	28	RM8003
M12 connector · Output function CANopen interface · Connector group 205									
	24 bits	9...30	–	–	12	-40...85	axial	29	RM8004



Absolute singleturn-encoders (Profibus)

Type	Resolution	U _b [V]	f [kHz]	I _{load} [mA]	Shaft [mm]	Ambient temperature [°C]	Cable entry	Drawing no.	Order no.
Terminals · Output function Profibus data interface									
	13 bits	10...30	–	–	10	-40...85	–	30	RN3001

Absolute multiturn encoders (Profibus)

Type	Resolution	U _b [V]	f [kHz]	I _{load} [mA]	Shaft [mm]	Ambient temperature [°C]	Cable entry	Drawing no.	Order no.
------	------------	-----------------------	------------	---------------------------	---------------	-----------------------------	-------------	-------------	-----------



Terminals · Output function Profibus data interface

	25 bits	10...30	–	–	6	-40...85	–	31	RM3006
	25 bits	10...30	–	–	10	-40...85	–	32	RM3007
	25 bits	10...30	–	–	12	-40...85	–	33	RM3008

Absolute multiturn encoders (ProfiNet)

Type	Resolution	U _b [V]	f [kHz]	I _{load} [mA]	Shaft [mm]	Ambient temperature [°C]	Cable entry	Drawing no.	Order no.
------	------------	-----------------------	------------	---------------------------	---------------	-----------------------------	-------------	-------------	-----------



M12 connector · Output function Profinet IO data interface · Connector groups 8, 9, 10, 11, 18, 19, 21, 23, 25, 148, 149, 150, 151, 153, 154, 184, 188, 190, 193, 202, 203, 204

	25 bits	10...30	–	–	10	-40...85	–	34	RM3011
	25 bits	10...30	–	–	12	-40...85	–	35	RM3010

Absolute singleturn-encoders (CANopen)

Type	Resolution	U _b [V]	f [kHz]	I _{load} [mA]	Shaft [mm]	Ambient temperature [°C]	Cable entry	Drawing no.	Order no.
------	------------	-----------------------	------------	---------------------------	---------------	-----------------------------	-------------	-------------	-----------

Terminals · Output function CANopen interface

	13 bits	10...30	–	–	6	-40...85	–	36	RN7011
	13 bits	10...30	–	–	10	-40...85	–	30	RN7012





Sensors for motion control

Absolute multiturn-encoders (CANopen)

Type	Resolution	U _b [V]	f [kHz]	I _{load} [mA]	Shaft [mm]	Ambient temperature [°C]	Cable entry	Drawing no.	Order no.
------	------------	-----------------------	------------	---------------------------	---------------	-----------------------------	-------------	-------------	-----------



Terminals · Output function CANopen interface

	25 bits	10...30	–	–	6	-40...85	–	31	RM7011
	25 bits	10...30	–	–	10	-40...85	–	32	RM7012

M12 connector · Output function CANopen interface · Connector group 205



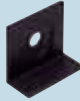

	4096	9...30	–	–	10	-40...85	axial	37	RM9010
---	------	--------	---	---	----	----------	-------	----	--------

Fixing accessories for encoders

Type	Description	Order no.
	Resilient base for angle flanges · Housing materials: aluminium black anodised	E60036
	Angle bracket · for encoders · for type RB, RC, RM, RN, RU · Housing materials: aluminium black anodised	E60033
	Angle bracket · for encoders · for type RM, RMU, RN, RU · Housing materials: aluminium black anodised	E60034
	Angle bracket · for encoders · for type RMV, RV · Housing materials: aluminium black anodised	E60035
	Angle bracket · for encoders · for type RM · Housing materials: aluminium black anodised	E60302
	Fastening clamp · for solid shaft encoders · Housing materials: steel	E60041



Couplings for encoders

Type	Description	Order no.
	Flexible coupling with clamp connection [KV] · Ø 6 mm / 1/4" / 1/4 inch / [6.35 mm] · Housing materials: aluminium	E60206









Type	Description	Order no.
	Flexible coupling with clamp connection [KV] · Ø 6 mm / Ø 3/8" / 3/8 inch / [9.525 mm] · Housing materials: aluminium	E60207
	Flexible coupling with clamp connection [KV] · Ø 10 mm / Ø 1/2" / 1/2 inch / [12.7 mm] · Housing materials: aluminium	E60208
	Flexible coupling with clamp connection [KV] · Ø 10 mm / Ø 3/8" / 3/8 inch / [9.525 mm] · Housing materials: aluminium	E60209
	Flexible coupling with clamp connection [KV] · Ø 4 mm / Ø 6 mm · Housing materials: aluminium	E60119
	Flexible coupling with clamp connection [KV] · Ø 6 mm / Ø 6 mm · Housing materials: aluminium	E60064
	Flexible coupling with clamp connection [KV] · Ø 6 mm / Ø 6 mm · Housing materials: aluminium	E60065
	Flexible coupling with clamp connection [KV] · Ø 6 mm / Ø 8 mm · Housing materials: aluminium	E60120
	Flexible coupling with clamp connection [KV] · Ø 6 mm / Ø 10 mm · Housing materials: aluminium	E60066
	Flexible coupling with clamp connection [KV] · Ø 10 mm / Ø 10 mm · Housing materials: aluminium	E60067
	Flexible coupling with adjusting screw connection [SV] · Ø 4 mm / Ø 6 mm · Housing materials: aluminium	E60062
	Flexible coupling with adjusting screw connection [SV] · Ø 6 mm / Ø 6 mm · Housing materials: aluminium	E60063
	Flexible coupling with adjusting screw connection [SV] · Ø 6 mm / Ø 8 mm · Housing materials: aluminium	E60027
	Flexible coupling with adjusting screw connection [SV] · Ø 6 mm / Ø 10 mm · Housing materials: aluminium	E60028
	Flexible coupling with adjusting screw connection [SV] · Ø 10 mm / Ø 10 mm · Housing materials: aluminium	E60022
	Spring disc coupling electrically isolating · Ø 6 mm / Ø 6 mm · Housing materials: diecast zinc / PA	E60121
	Spring disc coupling electrically isolating · Ø 6 mm / Ø 10 mm · Housing materials: diecast zinc / PA	E60117



Sensors for motion control



Type	Description	Order no.
	Spring disc coupling electrically isolating · Ø 10 mm / Ø 10 mm · Housing materials: diecast zinc / PA	E60118
	Plastic beam coupling with stainless steel hub · Ø 10 mm / Ø 10 mm · Housing materials: PA 6.6 / stainless steel 316L / 1.4404	E60193

Measuring wheels for encoders

Type	Description	Order no.
	Measuring wheel · Ø 63.6 mm / Ø 6 mm · cross-knurl · Housing materials: wheel: aluminium / surface characteristics: aluminium	E60006
	Measuring wheel · Ø 63.6 mm / Ø 10 mm · cross-knurl · Housing materials: wheel: aluminium / surface characteristics: aluminium	E60095
	Measuring wheel · Ø 63.66 ±0.1 mm / Ø 6 mm · smooth plastic · Housing materials: wheel: aluminium / surface characteristics: PU	E60111
	Measuring wheel · Ø 63.66 ±0.1 mm / Ø 10 mm · smooth plastic · Housing materials: wheel: aluminium / surface characteristics: PU	E60112
	Measuring wheel · Ø 63.66 ±0.1 mm / Ø 6 mm · grooved plastic · Housing materials: wheel: aluminium / surface characteristics: PU	E60137
	Measuring wheel · Ø 63.66 ±0.1 mm / Ø 10 mm · grooved plastic · Housing materials: wheel: aluminium / surface characteristics: PU	E60138
	Measuring wheel · Ø 159.15 mm / Ø 10 mm · cross-knurl · Housing materials: wheel: aluminium / surface characteristics: aluminium	E60098
	Measuring wheel · Ø 159.16 mm / Ø 10 mm · rubber · Housing materials: wheel: aluminium / surface characteristics: PU	E60076
	Measuring wheel · Ø 159.15 mm / Ø 10 mm · smooth plastic · Housing materials: wheel: aluminium / surface characteristics: PU	E60110

Connectors for encoders

Type	Description	Order no.
	Socket · angled · Free from silicone · Free from halogen · Gold-plated contacts · For applications in particularly harsh environments · M12 connector · 2 m · Housing materials: housing: TPU orange / sealing: FKM	EVM039

Type	Description	Order no.
	Socket · angled · Free from silicone · Free from halogen · Gold-plated contacts · M12 connector with integrated CAN terminating resistor (120 ohm) · 5 m · Housing materials: housing: TPU black / sealing: FKM	EVC492
	Socket · straight · Free from silicone · Free from halogen · Gold-plated contacts · For applications in particularly harsh environments · M12 connector · 2 m · Housing materials: housing: TPU orange / sealing: FKM	EVM036
	Socket · straight · M12 connector · 2 m · Housing materials: TPU	E12402
	Jumper · straight / straight · Free from halogen · 0.3 m · Housing materials: PUR	E12432

Scale drawings / drawing no. – CAD download: www.ifm.com

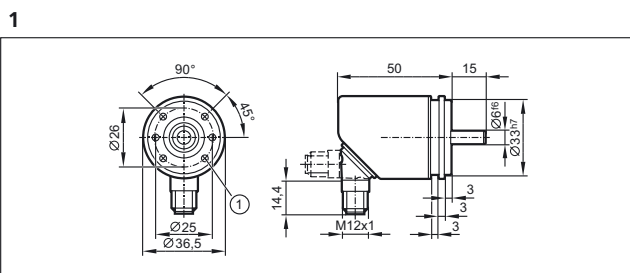

1: M3 x 0.5 6 mm deep

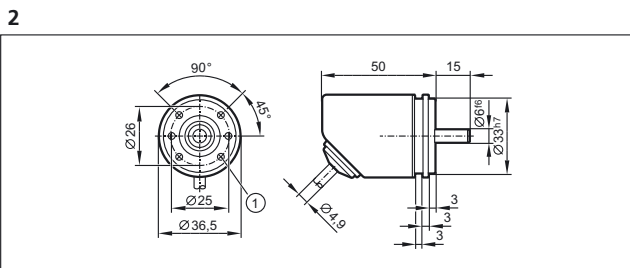

1: M3 x 0.5 6 mm deep

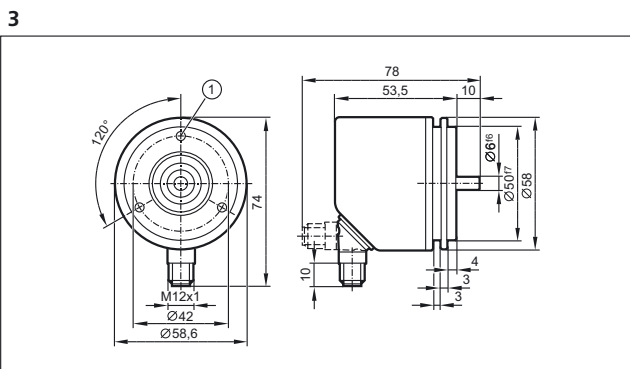

1: M4 x 0.7 6 mm deep

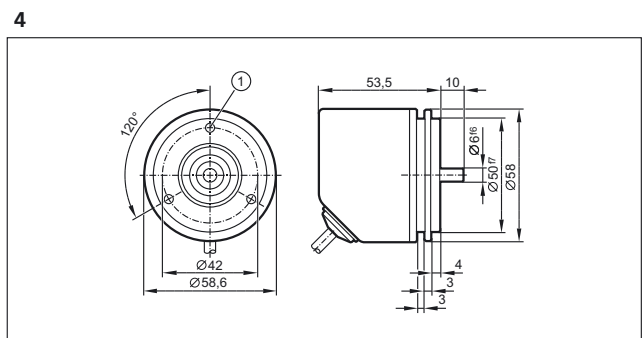

1: M4 x 0.7 6 mm deep

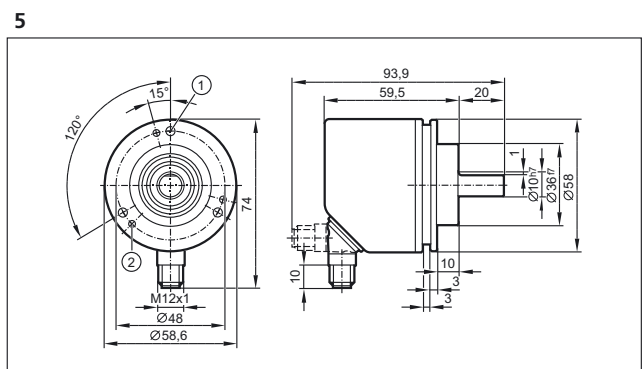

1: M4 x 0.7 6 mm deep, 2: M3 x 0.5 6 mm deep

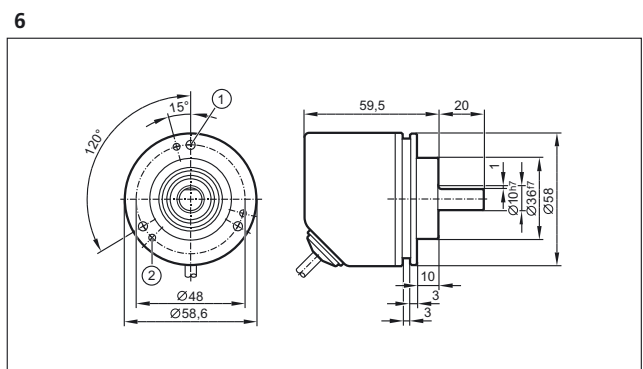

1: M4 x 0.7 6 mm deep, 2: M3 x 0.5 6 mm deep



Sensors for motion control

Scale drawings / drawing no. – CAD download: www.ifm.com

7

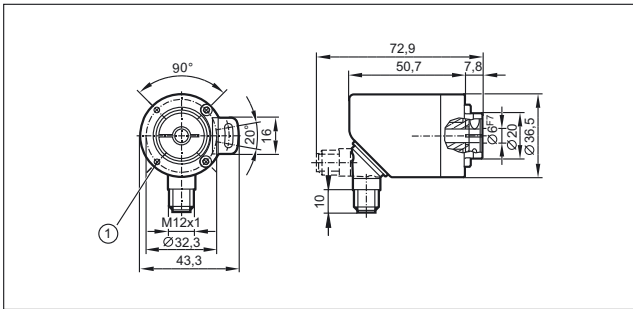

M2.5 x 0.45 6mm deep

8

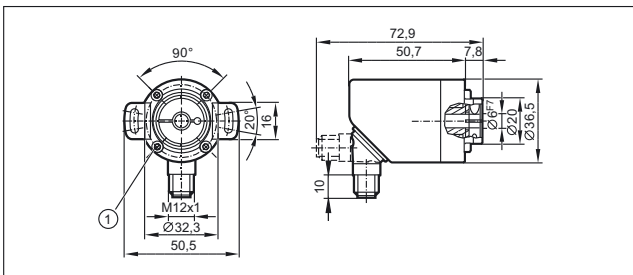

1: M3 x 0.5 6 mm deep

9

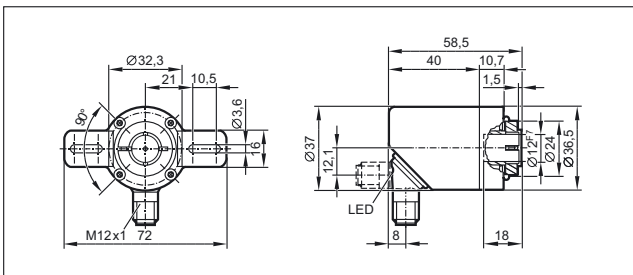

10

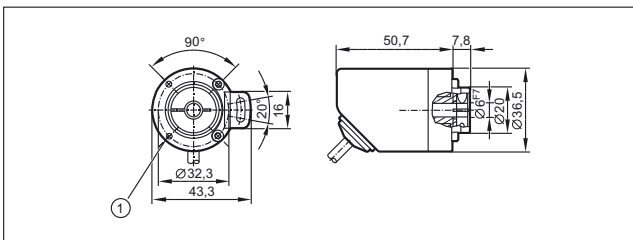

11

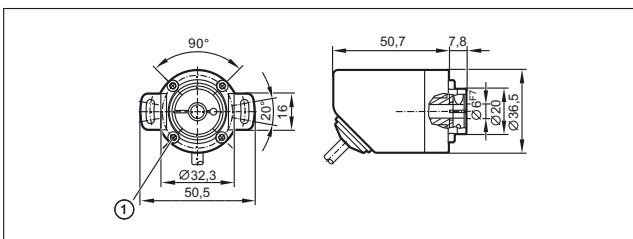

12

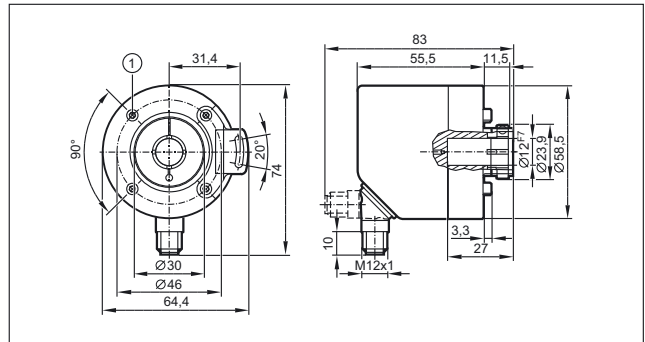

1: M3 x 0.5 6 mm deep

13

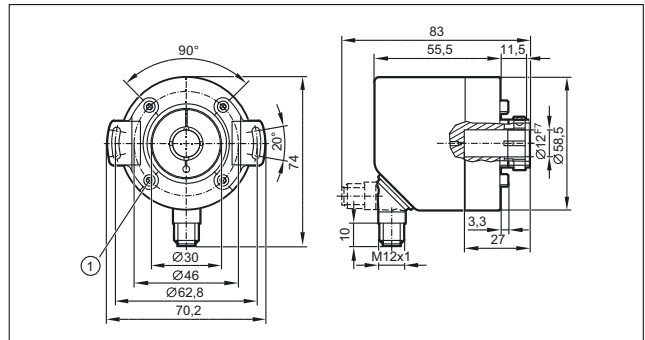

14

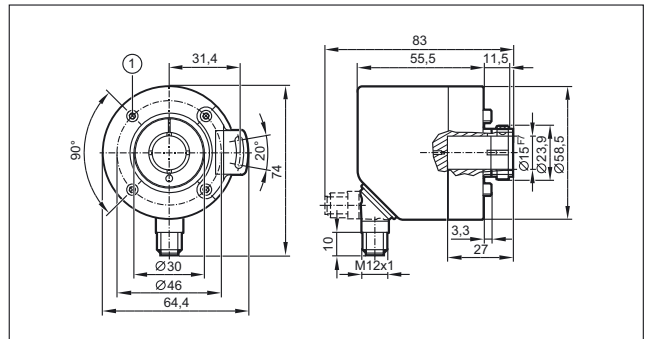

15

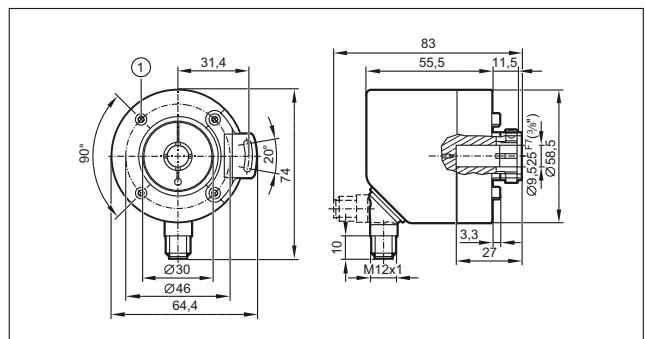

Scale drawings / drawing no. – CAD download: www.ifm.com

16

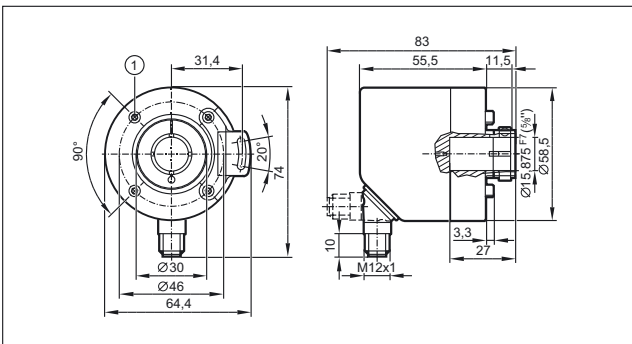

20

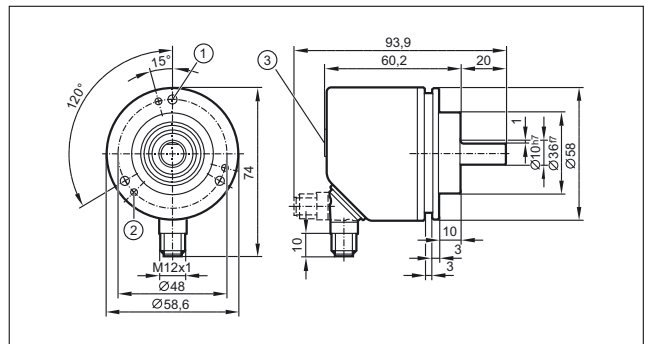

1: M4 x 0.7 6 mm deep, 2: M3 x 0.5 6 mm deep, 3: display

17

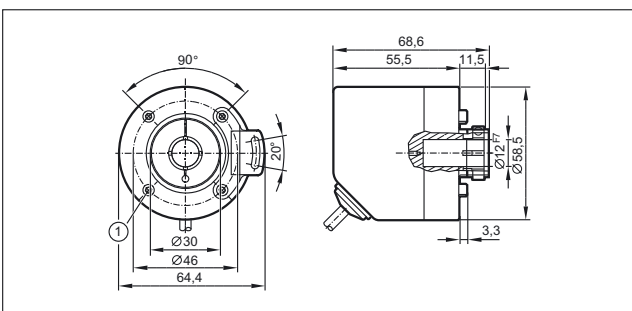

21

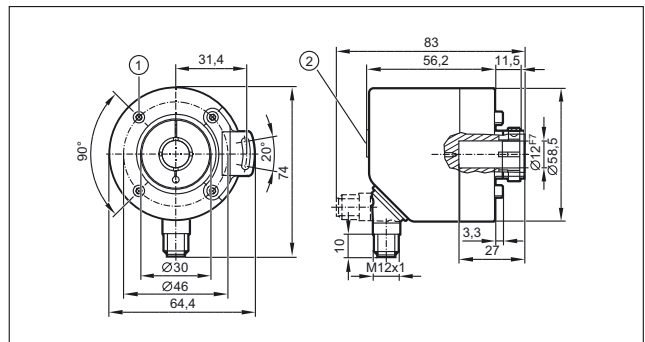

18

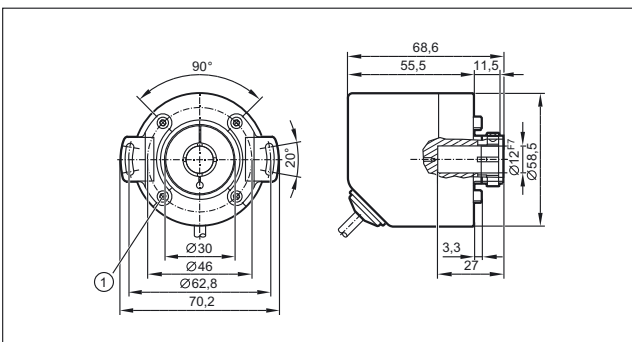

22

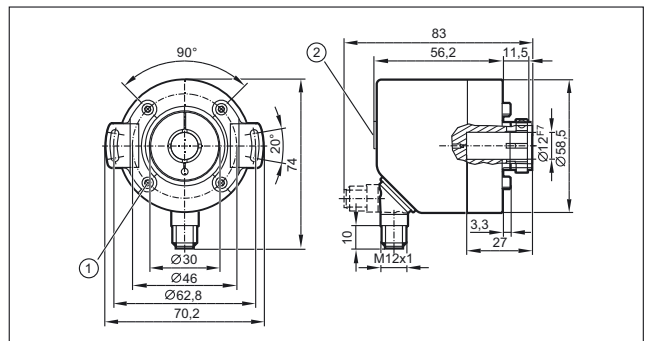

19

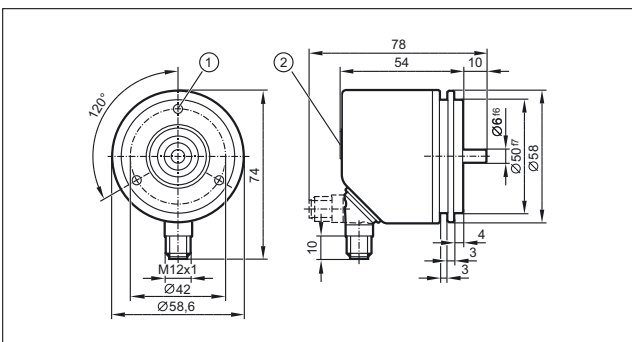

1: M4 x 0.7 6 mm deep, 2: display

23

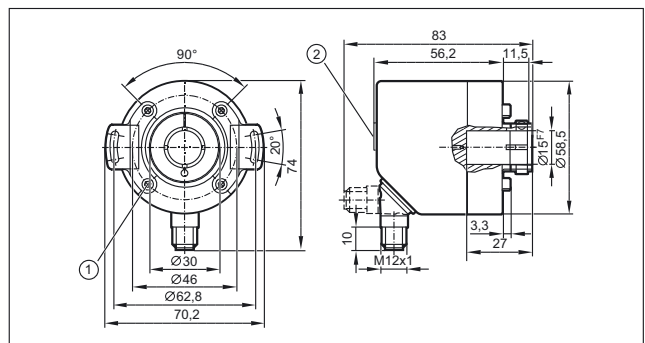



Sensors for motion control

Scale drawings / drawing no. – CAD download: www.ifm.com

24

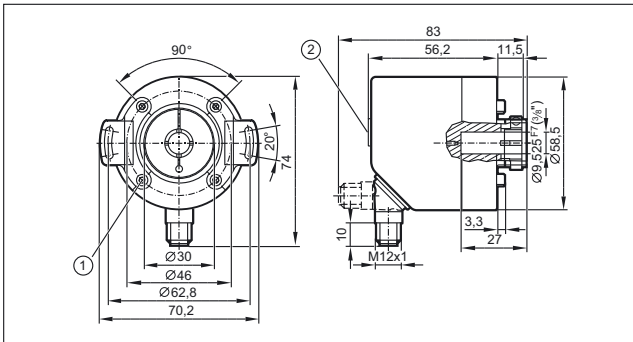

25

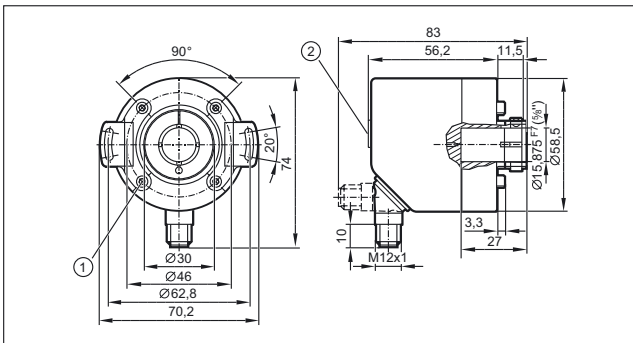

26

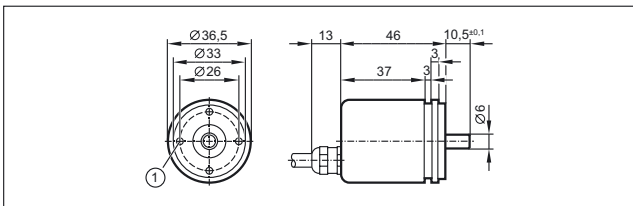

M3 6 mm deep

27

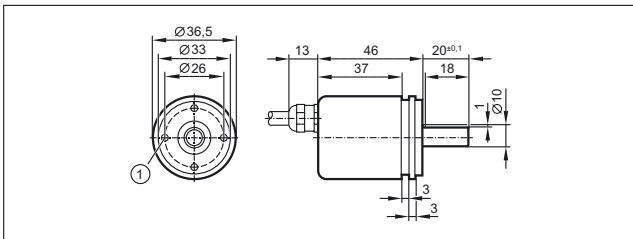

M3 6 mm deep

28

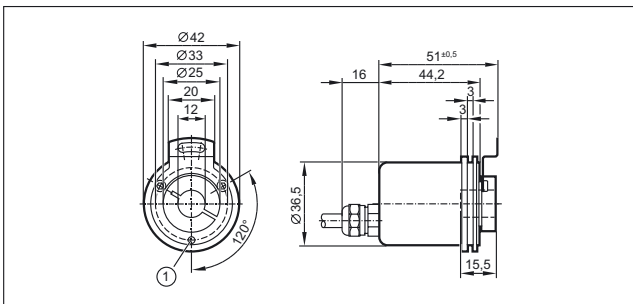

1: M3 x 6

29

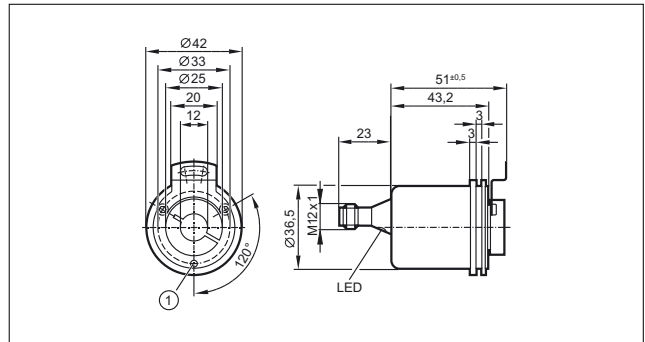

1: M3 x 6

30

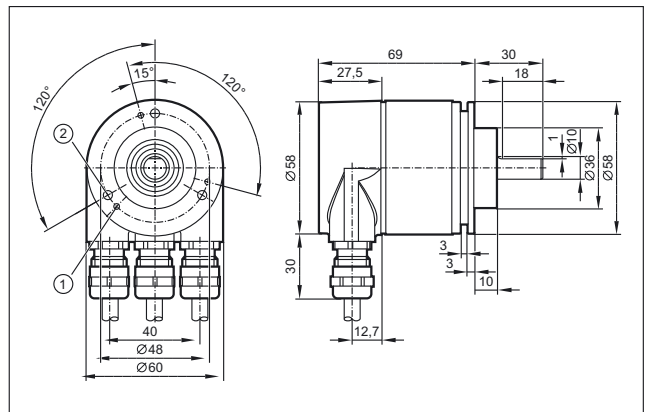

1: M3 6 mm deep, 2: M4 6 mm deep

31

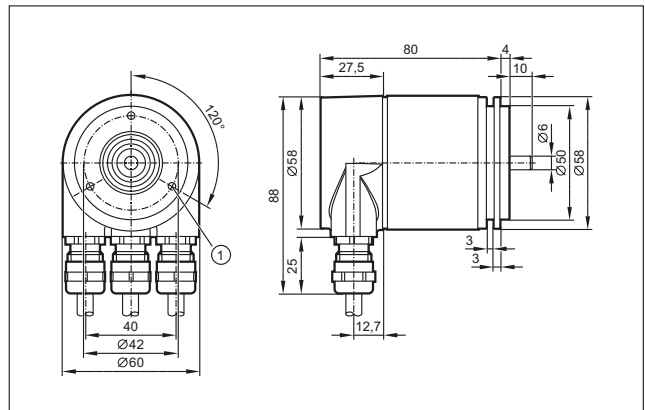

32

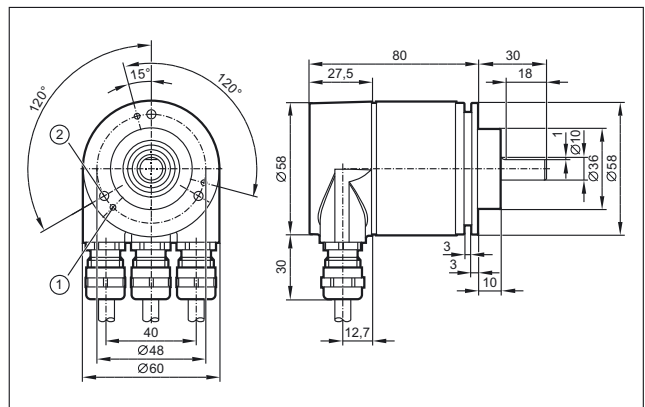

1: M3 6 mm deep, 2: M4 6 mm deep

Scale drawings / drawing no. – CAD download: www.ifm.com

33

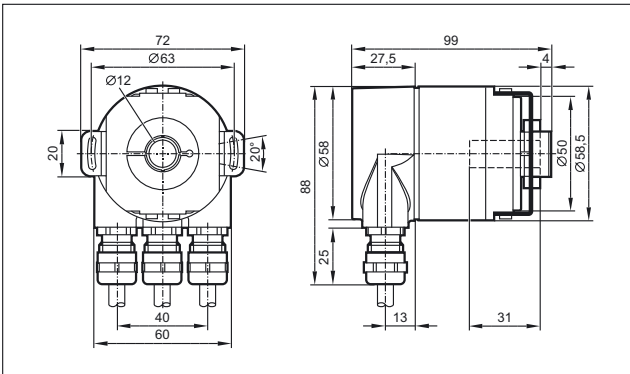

35

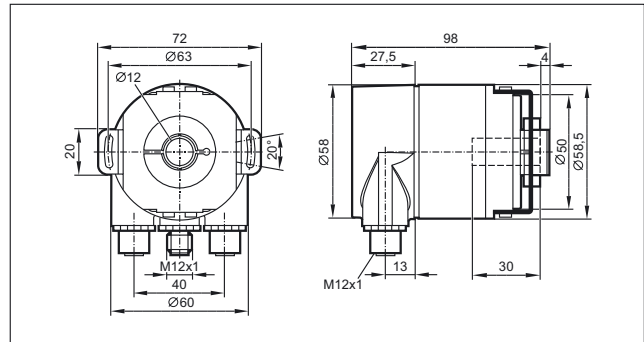

34

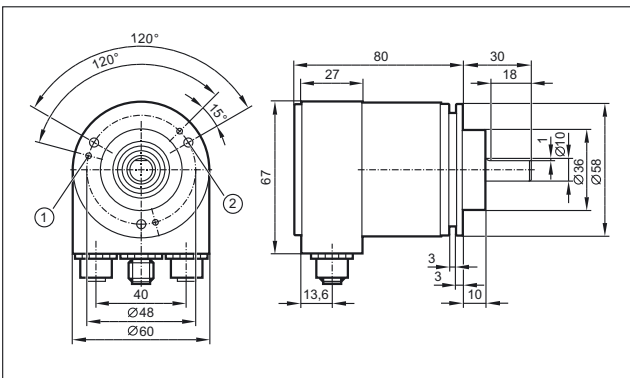

1: M3 6 mm deep, 2: M4 6 mm deep

36

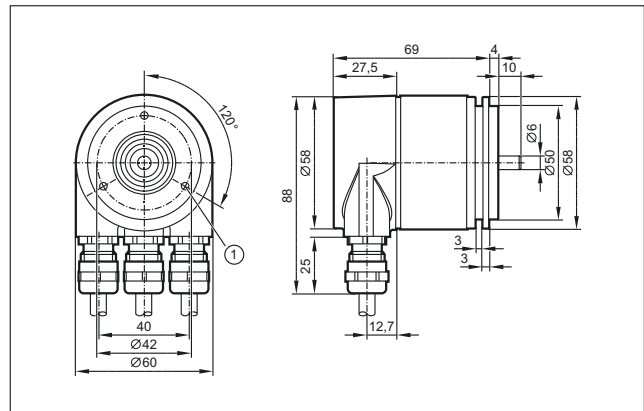

37

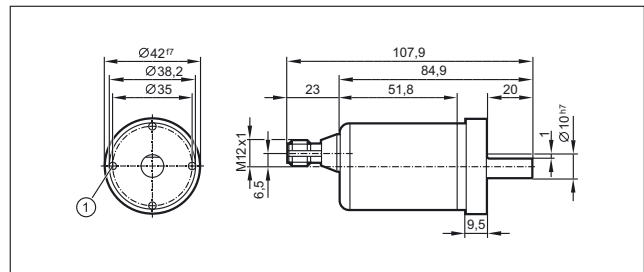

1: M4 8 mm deep



Sensor with integrated speed evaluation



Speed sensors



2 in 1: speed sensor and evaluation in one compact housing

Space-saving design

Easy to fit

Easy parameter setting by potentiometer or pushbutton

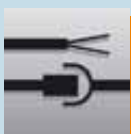

Inductive sensor with integrated speed evaluation

In many industrial applications drives need to be monitored for rotational speed or standstill. A typical application in building automation is V-belt monitoring on fans. In conveying, standstill monitoring is used to detect belt break on conveyors. A similar principle is applied in agricultural engineering to monitor elevator drives or detect failure of screw conveyors.

The compact DI series speed monitor offers a specially low-cost and reliable solution. In principle it is an inductive sensor with integrated speed evaluation. Advantage: the condition information of the drive is directly transferred to the control system.

The nominal speed is easily set by potentiometer or pushbutton.

System overview	Page
Speed monitor with integrated sensor	360
Speed monitors with integrated sensor, ATEX category 3D	361
Speed sensors with magnetic measuring principle	361 - 362
Accessories	362
Wiring diagrams	362 - 363
Scale drawings / drawing no. – CAD download: www.ifm.com	363 - 364



Sensors for motion control

Speed monitor with integrated sensor

Type	Dimensions [mm]	Sensing range [mm]	Electrical design	U _b [V]	Setting range [puls. / min.]	Start-up delay [s]	Draw- ing no.	Order no.
Output function · Wiring diagram no. 1 · Connector groups 8, 10, 11, 18, 19, 21, 23, 25, 148, 149, 150, 153, 154, 184, 188, 190, 193, 202, 203, 204								
	M18 / L = 68	12 nf	DC PNP	10...36 DC	3...6000	0...15	1	DI6001
Output function · Wiring diagram no. 2								
	M30 / L = 80	10 f	AC/DC	20...250 AC/DC	5...3600	< 0.5	2	DI0104*
	M30 / L = 80	10 f	AC/DC	20...250 AC/DC	5...3600	12	2	DI0101*
Output function · Wiring diagram no. 3 · Connector groups 8, 10, 11, 18, 19, 21, 23, 25, 148, 149, 150, 153, 154, 184, 188, 190, 193, 202, 203, 204								
	M30 / L = 82	10 f	DC PNP	10...36 DC	5...300	15	3	DI5009
Output function · Wiring diagram no. 4								
	M30 / L = 80	10 f	DC PNP	10...36 DC	5...3600	0	2	DI5022
	M30 / L = 80	10 f	DC PNP	10...36 DC	5...3600	15	2	DI5020
Output function · Wiring diagram no. 5								
	M30 / L = 80	10 f	DC PNP	10...36 DC	5...3600	5	2	DI5021
Output function · Wiring diagram no. 4								
	M30 / L = 80	10 f	DC PNP	10...36 DC	5...3600	15	2	DI520A
Output function · Wiring diagram no. 6								
	M30 / L = 80	10 f	DC PNP/NPN	10...36 DC	5...3600	0...30	2	DI5026
	M30 / L = 80	10 f	DC PNP/NPN	10...36 DC	5...3600	0...30	2	DI523A

f = flush / nf = non flush / qf = quasi-flush

* Note on use of miniature fuses for electrical connection

Miniature fuse to IEC60127-2 sheet 1, ≤ 2 A (fast acting) Recommendation: check the unit for reliable function after a short circuit.

Speed monitors with integrated sensor, ATEX category 3D

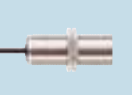

Type	Dimensions [mm]	Sensing range [mm]	Electrical design	U _b [V]	Setting range [puls. / min.]	Start-up delay [s]	Draw- ing no.	Order no.
------	--------------------	--------------------------	----------------------	-----------------------	------------------------------------	--------------------------	---------------------	--------------

Output function  · Wiring diagram no. 2

	M30 / L = 80	10 f	AC/DC	20...250 AC/DC	5...3600	12	2	DI103A*
---	--------------	------	-------	----------------	----------	----	---	---------

Output function  · Wiring diagram no. 3 · Connector group --

	M30 / L = 82	10 f	DC PNP	10...36 DC	5...300	15	4	DI505A
	M30 / L = 82	10 f	DC PNP	10...36 DC	5...300	5	4	DI506A

Output function  /  · Wiring diagram no. 1 · Connector group --

	M18 / L = 68	8 nf	DC PNP	10...36 DC	3...6000	0...15	5	DI602A
--	--------------	------	--------	------------	----------	--------	---	--------

f = flush / nf = non flush / qf = quasi-flush



* Note on use of miniature fuses for electrical connection

Miniature fuse to IEC60127-2 sheet 1, ≤ 2 A (fast acting) Recommendation: check the unit for reliable function after a short circuit.

Speed sensors with magnetic measuring principle

Type	Dimensions [mm]	Sensing range [mm]	Electrical design	U _b [V]	Connection	Ambient temperature sensor [°C]	Draw- ing no.	Order no.
------	--------------------	--------------------------	----------------------	-----------------------	------------	--	---------------------	--------------

Wiring diagram no. 7

	Ø 15 / L = 49.5	1.7	DC NPN	15	PUR cable	-32...140	6	MX5015
	Ø 15 / L = 50	1.7	DC NPN	15	PUR cable	-32...140	7	MX5017

Output function  · Wiring diagram no. 8 · Connector groups 8, 10, 19, 21, 23, 25, 148, 149, 153, 184, 188, 193, 202

	Ø 15 / L = 60	1.7	DC PNP	10...30 DC	PUR cable	-32...85	8	MX5050
---	---------------	-----	--------	------------	-----------	----------	---	--------

Wiring diagram no. 9

	–	1.7	DC NPN	7...30 DC	AMP Junior Timer connector (282 1921)	-32...140	9	MX5004
---	---	-----	--------	-----------	--	-----------	---	--------



Sensors for motion control

Type	Dimensions [mm]	Sensing range [mm]	Electrical design	U _b [V]	Connection	Ambient temperature sensor [°C]	Draw- ing no.	Order no.
------	--------------------	-----------------------	-------------------	-----------------------	------------	------------------------------------	------------------	-----------

Wiring diagram no. 9

	–	1.7	DC NPN	7...30 DC	AMP Junior Timer connector (282 1921)	-32...140	10	MX5000
---	---	-----	--------	-----------	---------------------------------------	-----------	----	---------------

Accessories

Type	Description	Order no.
	Angle bracket · for type M18 · Housing materials: stainless steel	E10736
	Angle bracket · for type M30 · Housing materials: stainless steel	E10737
	Mounting clamp · Ø 20 mm · Ø 18 mm · with reducing bush · for type M18 · Housing materials: PBT	E10076
	Mounting clamp · Ø 34 mm · Ø 30 mm · with reducing bush · for type M30 · Housing materials: PBT	E10077
	Target wheel · Plastic disk with 8 screws as "target" · Centered drill holes	E89010
	Target for pulse pickups · Strap dimensions 7 x 145 mm	E89013
	Cable plug · straight · 10 m	E60303
	Amplifier · 1-channel · selectable for pnp and npn switching sensors · Output 24 V DC / 300 mA · short-circuit and overload protection · Housing materials: plastics: PC GF20	DN0210

Wiring diagrams

Core colours

BK	black
WH	white
BN	brown
BU	blue

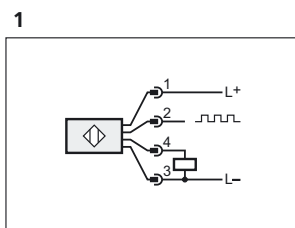

2: pulse output (the pulse sequence corresponds to the damping frequency),
4: switching output (adjustable)

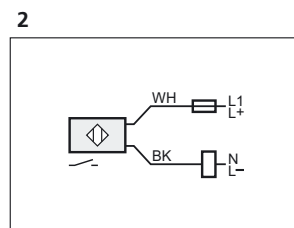

Note: miniature fuse to IEC60127-2 sheet 1, ≤ 2 A (fast acting)

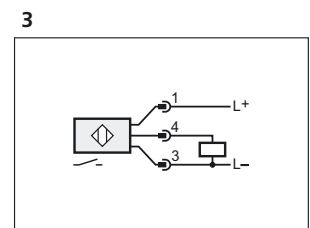

Wiring diagrams

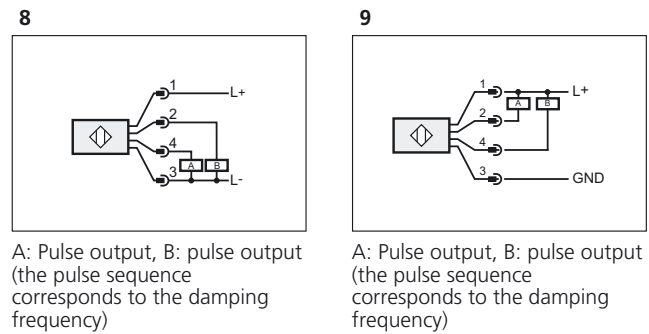
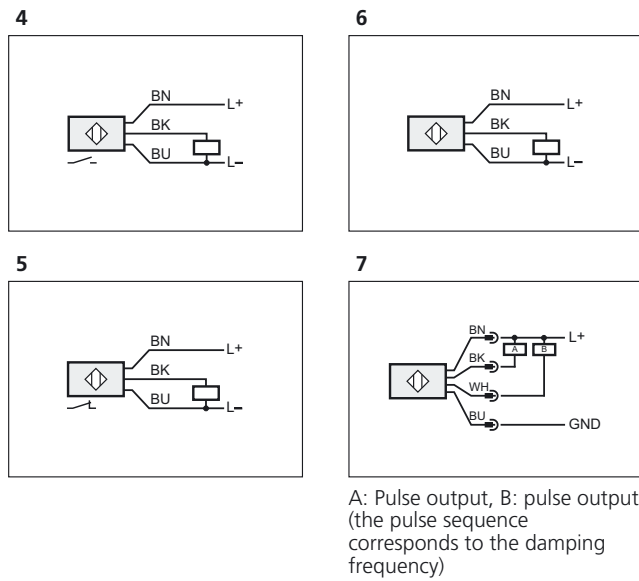

Scale drawings / drawing no. – CAD download: www.ifm.com

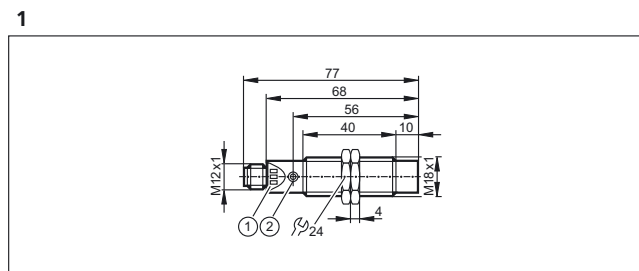

1: 3 LED, 2: setting pushbutton

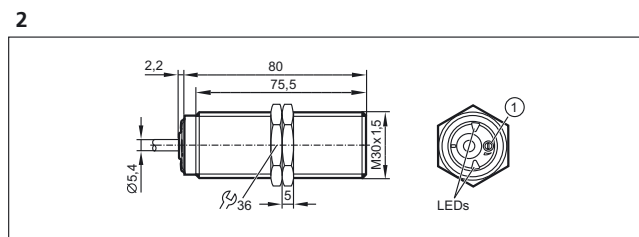

1: potentiometer

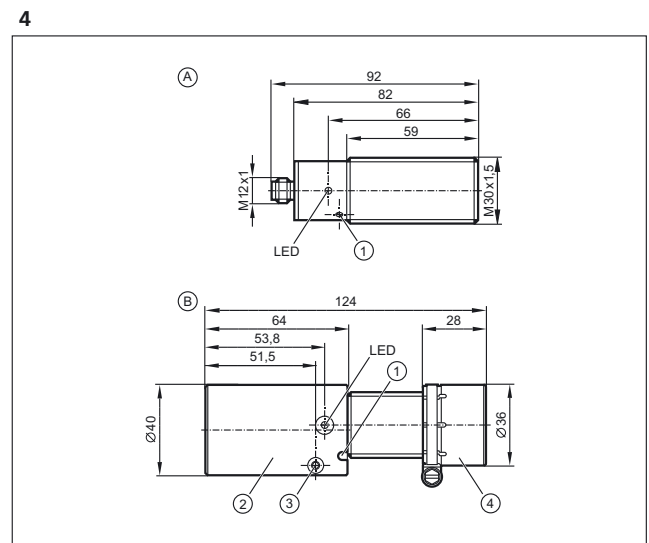
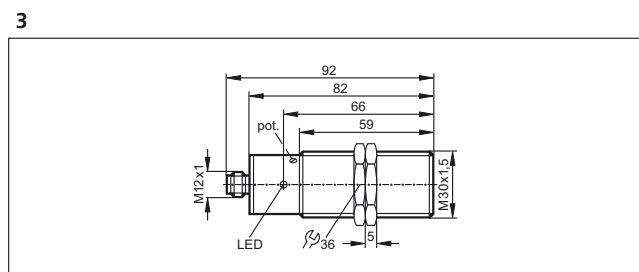

A: Sensor, B: sensor with impact protection housing, 1: potentiometer, 2: impact protection housing for the connector, 3: clamping screw, 4: impact protection housing for the sensor

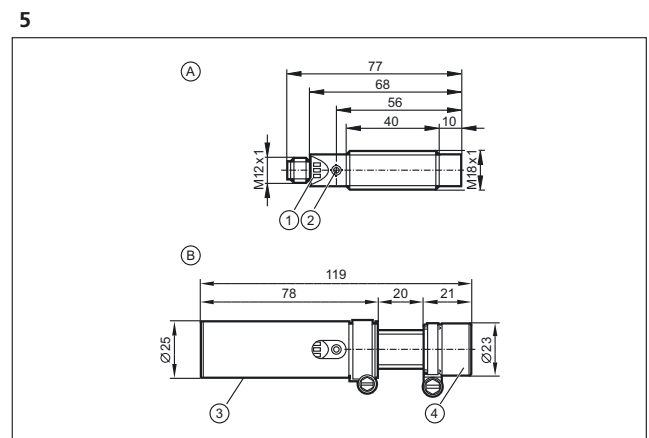

A: Sensor, B: sensor with impact protection housing, 1: 3 LED, 2: setting pushbutton, 3: impact protection housing for the connector, 4: impact protection housing for the sensor



Sensors for motion control

Scale drawings / drawing no. – CAD download: www.ifm.com

6

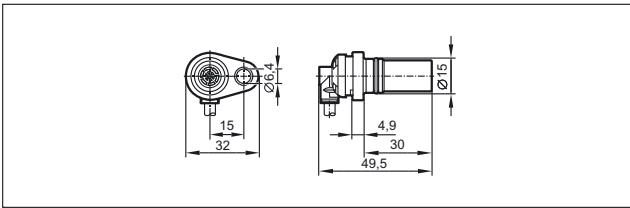

9

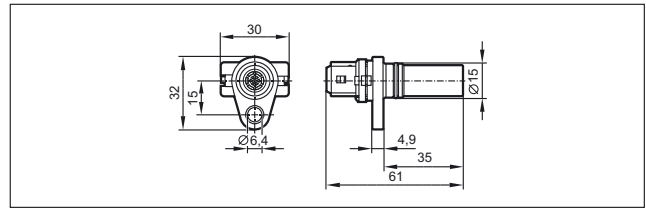

7

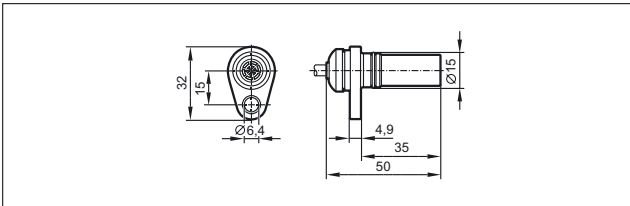

10

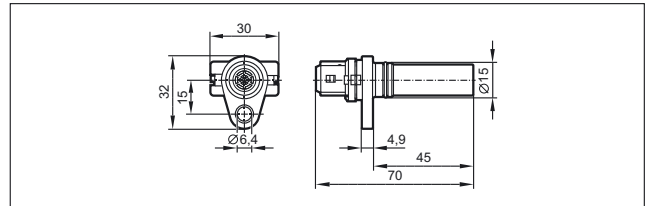

8

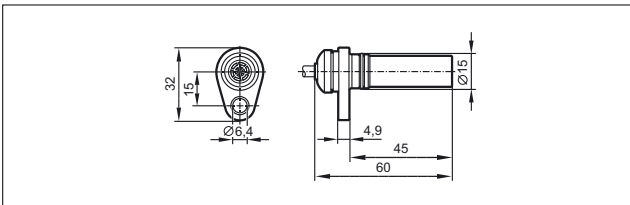





Inclination sensors measure each angle with precision



Inclination sensors



Compact and robust design

Wide angle range and high accuracy

Sensor types for signal output via CANbus, IO-Link as digital or analogue signal

High protection rating IP 65 to IP 69K

CAN and IO-Link sensors are freely configurable

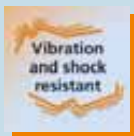

Inclination detection

Often the horizontal alignment of machines or machine parts is an important requirement for reliable operation.

Typical applications are cranes, access platforms or outriggers.

ifm inclination sensors differ by their signal outputs, number of measurement axes, the measuring range and the connection type. Depending on the sensor type, signal output is via CANbus, IO-Link, analogue or digital.

If only a switch point is to be detected, the mercury-free tilt sensor is used. Due to its design, it has the same good switching characteristics as a conventional mercury switch. Due to the harmless filling of the switching element with alcohol it has considerable ecological advantages in case of damage or disposal.

<i>System overview</i>	<i>Page</i>
Inclination sensors	368
Scale drawings / drawing no. – CAD download: www.ifm.com	368 - 369





Sensors for motion control

Inclination sensors

Type	Description	Draw- ing no.	Order no.
	Inclination sensor · 0...360° / ± 180° · CANopen interface · Self-test function · Heartbeat · Emergency messages available · housing: diecast zinc nickel-plated	1	JN2100
	Inclination sensor · ± 180° · Self-test function · IO-Link interface · Analogue interfaces (voltage / current) · Analogue / binary outputs · housing: diecast zinc nickel-plated	2	JN2200
	Inclination sensor · 0...360° / ± 180° · SAE J1939 interface · Self-test function · Diagnostic Trouble Code (DTC) available · housing: diecast zinc nickel-plated	1	JN2300
	Inclination sensor · ± 45° · CANopen interface · Self-test function · Heartbeat · Emergency messages available · housing: diecast zinc nickel-plated	1	JN2101
	Inclination sensor · ± 45° · Self-test function · IO-Link interface · Analogue interfaces (voltage / current) · Analogue / binary outputs · housing: diecast zinc nickel-plated	2	JN2201
	Inclination sensor · ± 45° · SAE J1939 interface · Self-test function · Diagnostic Trouble Code (DTC) available · housing: diecast zinc nickel-plated	1	JN2301
	Inclination sensor · ± 90° · 15...30 V DC · Output 0...10 V · Cable	3	EC2019
	Inclination sensor · ± 90° · Input 8...30 V DC · Output 0.5...4.5 V · Cable	3	EC2045
	Inclination sensor · ± 20° · Analogue output · 4...20 mA	3	EC2060
	Inclination sensor · ± 90° · Analogue output · 4...20 mA · Cable with connector	3	EC2082
	Tilt sensor · free from mercury · semi-conductor output · 10...30 V DC · Cable	4	EC2061

Scale drawings / drawing no. – CAD download: www.ifm.com

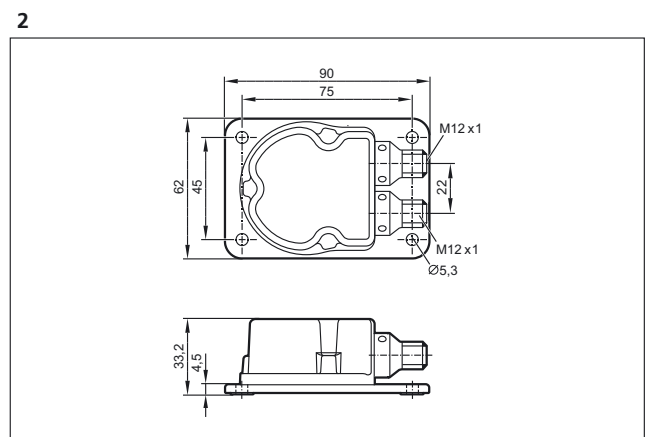
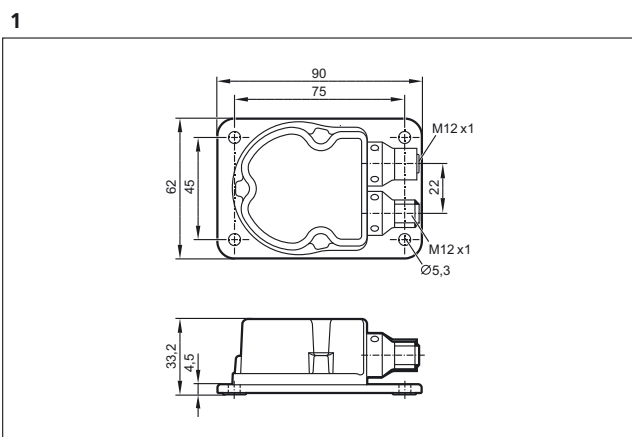

Product selectors and further information can be found at: www.ifm.com

Scale drawings / drawing no. – CAD download: www.ifm.com

3

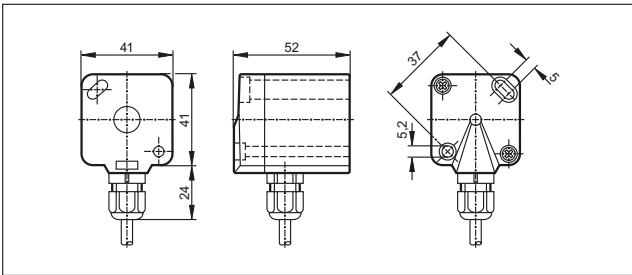

4

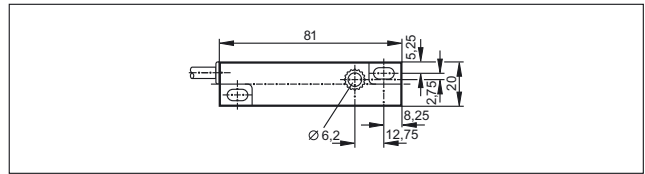



Versatile pulse evaluation systems



Pulse evaluation systems



Easy parameter setting

Primary voltage 24V DC or 110 / 230V AC, wide-range input

Programmable switching characteristics

Standstill, overspeed, direction, slip and frequency conversion, counter

Switching relays and transistor outputs, scalable analogue output

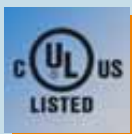
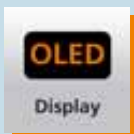
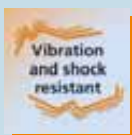
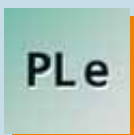

Evaluation systems

Although PLC applications in industrial automation are becoming more and more versatile, there are still numerous processes which require decentralised monitoring.

For this purpose, ifm offers various pulse evaluation systems:

- speed monitors
- standstill monitor
- slip / synchronous monitors
- direction monitor
- frequency-to-current converter
- threshold relay
- displays with frequency and analogue input
- counter
- processing of analogue standard signals

System overview	Page
Universal speed monitors	372
Universal speed monitors with sensor wire monitoring	372
Dual speed monitors	372
Dual speed monitors with sensor wire monitoring	372
Standard speed monitors / standstill monitor	373
Level monitoring relays	373
Level control relays	373
Slip monitors	373
Slip monitors with sensor wire monitoring	374
Slip / synchronous monitors	374
Slip / synchronous monitors with sensor wire monitoring	374
Combined direction and speed monitors	374
Frequency-to-current converters	375
2-channel threshold relay for analogue standard signals	375
Safety standstill monitors, SIL 3, PL e	375
Safety speed monitor, SIL 3, PL e	375
Multifunctional displays for digital signals / frequency input	376
Multifunctional displays for analogue standard signals	376 - 377
Universal counters	377
Accessories pulse divider / pulse stretcher	377
Accessories	377 - 378
Scale drawings / drawing no. – CAD download: www.ifm.com	378 - 379



Sensors for motion control

Universal speed monitors

Type	U _b [V]	In-puts	Input function	Setting range [puls. / min.]	Setting range [Hz]	Out-puts analogue	Out-puts relays	Out-puts transist.	Draw-ing no.	Order no.
------	-----------------------	---------	----------------	---------------------------------	-----------------------	-------------------	-----------------	--------------------	--------------	-----------

FR-1 · 2 switch points for monitoring overspeed/underspeed and acceptable range

	110...240 AC (50...60 Hz)/ 27 DC (typ. 24 DC)	1	PNP / NPN / Namur	1...60000	0.1...1000	1	2	2	1	DD2503
---	--	---	-------------------	-----------	------------	---	---	---	---	--------

Universal speed monitors with sensor wire monitoring

Type	U _b [V]	In-puts	Input function	Setting range [puls. / min.]	Setting range [Hz]	Out-puts analogue	Out-puts relays	Out-puts transist.	Draw-ing no.	Order no.
------	-----------------------	---------	----------------	---------------------------------	-----------------------	-------------------	-----------------	--------------------	--------------	-----------

FR-1N · 2 switch points for monitoring overspeed/underspeed and acceptable range

	110...240 AC (50...60 Hz)/ 27 DC (typ. 24 DC)	1	Namur 8.2 V	1...60000	0.1...1000	1	2	4	1	DD2603
---	--	---	-------------	-----------	------------	---	---	---	---	--------

Dual speed monitors

Type	U _b [V]	In-puts	Input function	Setting range [puls. / min.]	Setting range [Hz]	Out-puts analogue	Out-puts relays	Out-puts transist.	Draw-ing no.	Order no.
------	-----------------------	---------	----------------	---------------------------------	-----------------------	-------------------	-----------------	--------------------	--------------	-----------

FR-2 · 1 switch point each for monitoring overspeed/underspeed and acceptable range

	110...240 AC (50...60 Hz)/ 27 DC (typ. 24 DC)	2	PNP / NPN / Namur	1...60000	0.1...1000	–	2	2	1	DD2505
---	--	---	-------------------	-----------	------------	---	---	---	---	--------

Dual speed monitors with sensor wire monitoring

Type	U _b [V]	In-puts	Input function	Setting range [puls. / min.]	Setting range [Hz]	Out-puts analogue	Out-puts relays	Out-puts transist.	Draw-ing no.	Order no.
------	-----------------------	---------	----------------	---------------------------------	-----------------------	-------------------	-----------------	--------------------	--------------	-----------

FR-2N · 1 switch point each for monitoring overspeed/underspeed and acceptable range

	110...240 AC (50...60 Hz)/ 27 DC (typ. 24 DC)	2	Namur 8.2 V	1...60000	0.1...1000	–	2	4	1	DD2605
---	--	---	-------------	-----------	------------	---	---	---	---	--------

Standard speed monitors / standstill monitor

Type	U _b [V]	In-puts	Input function	Setting range [puls. / min.]	Setting range [Hz]	Out-puts analogue	Out-puts relays	Out-puts transist.	Draw-ing no.	Order no.
------	-----------------------	---------	----------------	---------------------------------	-----------------------	-------------------	-----------------	--------------------	--------------	-----------

D200 · evaluation of pulse sequences with regard to overspeed and underspeed; rotational speed monitoring

	110...240 AC / 27 (24) DC	1	PNP	0.1...10 / 10...1000	–	–	1	–	2	DD0203
	110...240 AC / 27 (24) DC	1	PNP	0.2...20 / 20...2000	–	–	1	–	2	DD0296

Level monitoring relays

Type	U _b [V]	In-puts	Input function	Setting range [puls. / min.]	Setting range [Hz]	Out-puts analogue	Out-puts relays	Out-puts transist.	Draw-ing no.	Order no.
------	-----------------------	---------	----------------	---------------------------------	-----------------------	-------------------	-----------------	--------------------	--------------	-----------

L200 · protection of a tank against overflow or running dry

	110...240 AC / 27 (24) DC	1	PNP	–	–	–	1	–	3	DL0201
--	------------------------------	---	-----	---	---	---	---	---	---	--------

Level control relays

Type	U _b [V]	In-puts	Input function	Setting range [puls. / min.]	Setting range [Hz]	Out-puts analogue	Out-puts relays	Out-puts transist.	Draw-ing no.	Order no.
------	-----------------------	---------	----------------	---------------------------------	-----------------------	-------------------	-----------------	--------------------	--------------	-----------

L200 · two point level control

	110...240 AC / 27 (24) DC	1	PNP	–	–	–	1	–	4	DL0203
---	------------------------------	---	-----	---	---	---	---	---	---	--------

Slip monitors

Type	U _b [V]	In-puts	Input function	Setting range	Out-puts relays	Out-puts transist.	Draw-ing no.	Order no.
------	-----------------------	---------	----------------	---------------	-----------------	--------------------	--------------	-----------

FS-1 · 1 switching output for slip monitoring; 1 switching output for overspeed/underspeed and acceptable range

	110...240 AC (50...60 Hz)/ 27 DC (typ. 24 DC)	1	PNP / NPN / Namur	slip: 0.1...99.9 % rotational speed (frequency): 1...60000 pulses/min (0.1...1000)	2	2	1	DS2503
---	--	---	-------------------	--	---	---	---	--------



Sensors for motion control

Slip monitors with sensor wire monitoring

Type	U _b [V]	In-puts	Input function	Setting range	Out-puts relays	Out-puts transist.	Draw-ing no.	Order no.
------	-----------------------	---------	----------------	---------------	-----------------	--------------------	--------------	-----------

FS-1N · 1 switching output for slip monitoring; 1 switching output for overspeed/underspeed and acceptable range

	110...240 AC (50...60 Hz)/ 27 DC (typ. 24 DC)	1	Namur 8.2 V	slip: 0.1...99.9 % rotational speed (frequency): 1...60000 pulses/min (0.1...1000)	2	2	1	DS2603
---	--	---	-------------	--	---	---	---	--------

Slip / synchronous monitors

Type	U _b [V]	In-puts	Input function	Setting range	Out-puts relays	Out-puts transist.	Draw-ing no.	Order no.
------	-----------------------	---------	----------------	---------------	-----------------	--------------------	--------------	-----------

FS-2 · 2 switch points for slip/synchronous monitoring

	110...240 AC (50...60 Hz)/ 27 DC (typ. 24 DC)	1	PNP / NPN / Namur	pulse differences: 1...999 reset time: 0.0...1000.0 s	2	2	1	DS2505
---	--	---	-------------------	--	---	---	---	--------

FS-3 · 2 switch points for synchronous monitoring

	110...240 AC (50...60 Hz)/ 27 DC (typ. 24 DC)	1	PNP / NPN / Namur	pulse differences: 1...999 hysteresis: 1...999	2	2	1	DS2506
---	--	---	-------------------	---	---	---	---	--------

Slip / synchronous monitors with sensor wire monitoring

Type	U _b [V]	In-puts	Input function	Setting range	Out-puts relays	Out-puts transist.	Draw-ing no.	Order no.
------	-----------------------	---------	----------------	---------------	-----------------	--------------------	--------------	-----------

FS-2N · 2 switch points for slip/synchronous monitoring

	110...240 AC (50...60 Hz)/ 27 DC (typ. 24 DC)	1	Namur 8.2 V	pulse differences: 1...999 reset time: 0.0...1000.0 s	2	2	1	DS2605
---	--	---	-------------	--	---	---	---	--------

Combined direction and speed monitors

Type	U _b [V]	In-puts	Input function	Setting range	Out-puts relays	Out-puts transist.	Draw-ing no.	Order no.
------	-----------------------	---------	----------------	---------------	-----------------	--------------------	--------------	-----------

FD-1 · 1 switching output for indication of direction; 1 switching output for overspeed/underspeed and acceptable range

	110...240 AC (50...60 Hz)/ 27 DC (typ. 24 DC)	1	PNP / NPN / Namur	cycle time: 0.0...1000 s rotational speed (frequency): 1...60000 pulses/min (1...1000)	2	2	1	DR2503
---	--	---	-------------------	--	---	---	---	--------

FD-2 · 2 switching outputs for separate indication of direction; adjustable reset times for standstill monitoring

	110...240 AC (50...60 Hz)/ 27 DC (typ. 24 DC)	1	PNP / NPN / Namur	reset time: 0.0...1000 s	2	2	1	DR2505
---	--	---	-------------------	--------------------------	---	---	---	--------

Frequency-to-current converters

Type	U _b [V]	In-puts	Input function	Setting range [puls. / min.]	Setting range [Hz]	Out-puts analogue	Out-puts relays	Out-puts transist.	Draw-ing no.	Order no.
------	-----------------------	---------	----------------	---------------------------------	-----------------------	-------------------	-----------------	--------------------	--------------	-----------

FA-1 · Conversion of pulse sequences into analogue standard signals

	110...240 AC (50...60 Hz)/ 27 DC (typ. 24 DC)	1	PNP / NPN / Namur	0...600000	0...10000	2	1	1	1	DW2503
---	--	---	-------------------	------------	-----------	---	---	---	---	--------

2-channel threshold relay for analogue standard signals

Type	U _b [V]	In-puts	Input function	Setting range [puls. / min.]	Setting range [Hz]	Out-puts analogue	Out-puts relays	Out-puts transist.	Draw-ing no.	Order no.
------	-----------------------	---------	----------------	---------------------------------	-----------------------	-------------------	-----------------	--------------------	--------------	-----------

AL-3 · 2-channel analogue threshold relay for analogue standard signals

	110...240 AC (50...60 Hz)/ 27 DC (typ. 24 DC)	2	2 x 0/4...20 mA	–	–	1	1	1	1	DL2503
---	--	---	-----------------	---	---	---	---	---	---	--------

Safety standstill monitors, SIL 3, PL e

Type	U _b [V]	In-puts	Input function	Setting range [puls. / min.]	Setting range [Hz]	Out-puts analogue	Out-puts relays	Out-puts transist.	Draw-ing no.	Order no.
------	-----------------------	---------	----------------	---------------------------------	-----------------------	-------------------	-----------------	--------------------	--------------	-----------

Monitoring rotational or linear movements for minimum switch point not reached (standstill)

	24 DC	1	PNP	–	0.2 / 0.5 / 1.0 / 2.0	–	2	1	5	DA102S
---	-------	---	-----	---	--------------------------	---	---	---	---	--------

Safety speed monitor, SIL 3, PL e

Type	U _b [V]	In-puts	Input function	Setting range [puls. / min.]	Setting range [Hz]	Out-puts analogue	Out-puts relays	Out-puts transist.	Draw-ing no.	Order no.
------	-----------------------	---------	----------------	---------------------------------	-----------------------	-------------------	-----------------	--------------------	--------------	-----------

Monitoring of rotational or linear movements for adherence to a maximum setpoint (overspeed)

	24 DC	1	PNP	–	-40...70	–	2	1	6	DD110S
	24 DC	1	PNP	–	-40...70	–	2	1	6	DD111S





Monitoring of rotational or linear movements for underspeed (minimum switch point not reached)

	24 DC	1	PNP	–	-40...70	–	2	1	6	DU110S
---	-------	---	-----	---	----------	---	---	---	---	--------









Sensors for motion control

Multifunctional displays for digital signals / frequency input

Type	Inputs / outputs	Description	Drawing no.	Order no.
AX460 · universal unit for displaying and monitoring analogue signals (e.g. pressure sensors, temperature sensors or flow sensors)				
	2 x analogue in	Digital display · Multi-functional display and evaluation system · for analogue standard signals · Ambient temperature -20...60 °C · screw terminals · Operating voltage 115...230 AC (50...60 Hz) / 18...30 V DC · IP 65	7	DX2041
	2 x analogue in 4 x digital out	Digital display · Multi-functional display and evaluation system · for analogue standard signals · Ambient temperature -20...60 °C · screw terminals · Operating voltage 115...230 AC (50...60 Hz) / 18...30 V DC · IP 65	7	DX2042
	2 x analogue in	Digital display · Multi-functional display and evaluation system · for analogue standard signals · Ambient temperature -20...60 °C · screw terminals · Operating voltage 18...30 V DC · IP 65	7	DX2051
	2 x analogue in 4 x digital out	Digital display · Multi-functional display and evaluation system · for analogue standard signals · Ambient temperature -20...60 °C · screw terminals · Operating voltage 18...30 V DC · IP 65	7	DX2052

Multifunctional displays for analogue standard signals

Type	Inputs / outputs	Description	Drawing no.	Order no.
FX460 · universal evaluation and display for all physical units which can be derived from pulse sequences				
	–	Digital display · Multi-functional display and evaluation system · Can be used for example as: · frequency meter/tachometer · processing time/baking time display · industrial timer · position and event counter · display of speed measured from elapsed time · Ambient temperature -20...60 °C · screw terminals · Operating voltage 115...230 AC (50...60 Hz) / 18...30 V DC · IP 65	7	DX2021
	–	Digital display · Multi-functional display and evaluation system · Can be used for example as: · frequency meter/tachometer · processing time/baking time display · industrial timer · position and event counter · display of speed measured from elapsed time · Analogue output · Ambient temperature -20...60 °C · screw terminals · Operating voltage 115...230 AC (50...60 Hz) / 18...30 V DC · IP 65	7	DX2022
	–	Digital display · Multi-functional display and evaluation system · Can be used for example as: · frequency meter/tachometer · processing time/baking time display · industrial timer · position and event counter · display of speed measured from elapsed time · Ambient temperature -20...60 °C · screw terminals · Operating voltage 115...230 AC (50...60 Hz) / 18...30 V DC · IP 65	7	DX2023
	–	Digital display · Multi-functional display and evaluation system · Can be used for example as: · frequency meter/tachometer · processing time/baking time display · industrial timer · position and event counter · display of speed measured from elapsed time · Ambient temperature -20...60 °C · screw terminals · Operating voltage 18...30 V DC · IP 65	7	DX2031
	–	Digital display · Multi-functional display and evaluation system · Can be used for example as: · frequency meter/tachometer · processing time/baking time display · industrial timer · position and event counter · display of speed measured from elapsed time · Analogue output · Ambient temperature -20...60 °C · screw terminals · Operating voltage 18...30 V DC · IP 65	7	DX2032
	–	Digital display · Multi-functional display and evaluation system · Can be used for example as: · frequency meter/tachometer · processing time/baking time display · industrial timer · position and event counter · display of speed measured from elapsed time · Ambient temperature -20...60 °C · screw terminals · Operating voltage 18...30 V DC · IP 65	7	DX2033

Decentralised display, preprocessing and conversion of 4...20 mA analogue signals

	normally open / closed programmable	Threshold display · 4...20 mA analogue input · transistor output · IO-Link interface · 4-digit alphanumeric display / alternating indication of red and green · Conversion of analogue measured values to an IO-Link communication · Analogue input 4...20 mA · Ambient temperature -25...60 °C · Operating voltage 18...30 V DC · IP 67	8	DP2200
---	-------------------------------------	--	---	---------------

Type	Inputs / outputs	Description	Drawing no.	Order no.
------	------------------	-------------	-------------	-----------

scalable display for sensors with analogue output (e.g. pressure sensors, flow sensors)

	-	LC display · LCD 3½ digits; 15 mm high · Supply from the current loop · Input 4...20 mA · Ambient temperature 0...60 °C · terminals up to 2.5 mm ² · IP 65	9	E89150
---	---	---	---	--------



Universal counters

Type	U _b [V]	In-puts	Input function	Setting range	Out-puts relays	Out-puts transist.	Drawing no.	Order no.
------	-----------------------	---------	----------------	---------------	-----------------	--------------------	-------------	-----------

preset counter with 2 presets

	90...260 AC	1	PNP / NPN	-	2	-	10	E89005
---	-------------	---	-----------	---	---	---	----	--------

Accessories pulse divider / pulse stretcher



Type	Description	Drawing no.	Order no.
	Pulse divider · Ratio input/output pulse 10:1 · Housing for DIN rail mounting · Terminals · Housing materials: plastics	11	E80100
	Pulse stretcher · Pulse length · IN (min): > 0.2 ms / OUT: 25 ms · Housing for DIN rail mounting · Terminals · Housing materials: plastics	11	E80110
	Pulse divider · Division 1...255	12	E80102

Accessories

Type	Description	Order no.
	Angle bracket · for type M18 · Housing materials: stainless steel	E10736
	Angle bracket · for type M30 · Housing materials: stainless steel	E10737
	Mounting clamp · Ø 20 mm - Ø 18 mm · with reducing bush · for type M18 · Housing materials: PBT	E10076
	Mounting clamp · Ø 34 mm - Ø 30 mm · with reducing bush · for type M30 · Housing materials: PBT	E10077



Sensors for motion control

Type	Description	Order no.
	mounting clip · Housing materials: 2.1247	E89208
	Target wheel · Plastic disk with 8 screws as "target" · Centered drill holes	E89010
	Target for pulse pickups · Strap dimensions 7 x 145 mm	E89013

Scale drawings / drawing no. – CAD download: www.ifm.com

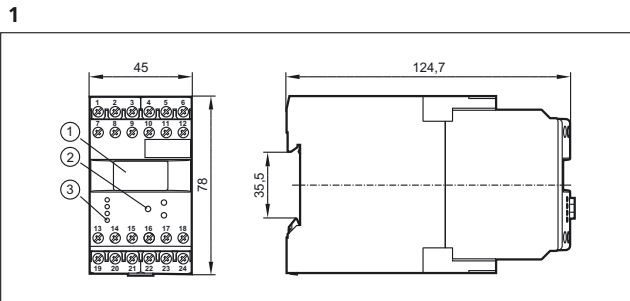

1: OLED display, 2: Programming buttons, 3: LEDs

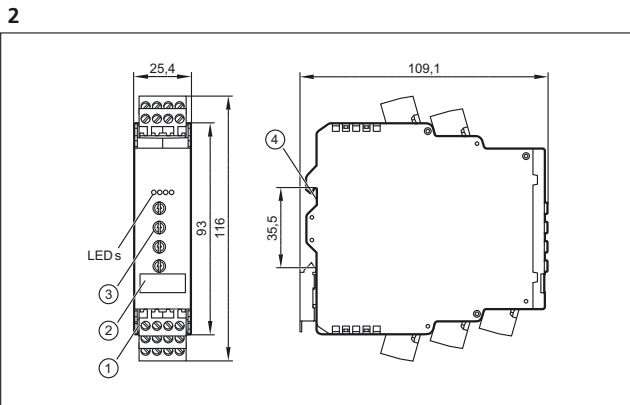

1: plug-in screw terminals, 2: label, 3: potentiometer, 4: Mounting on DIN rail

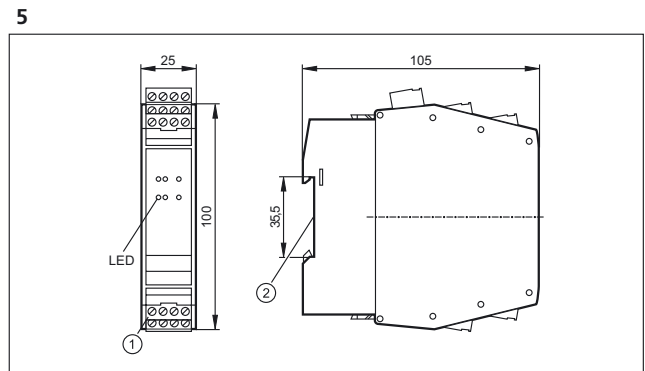
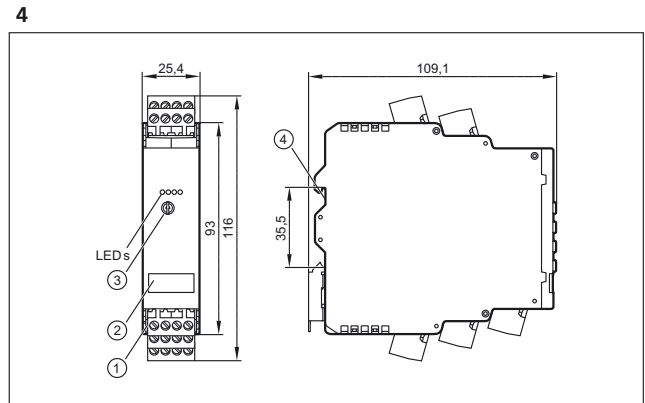
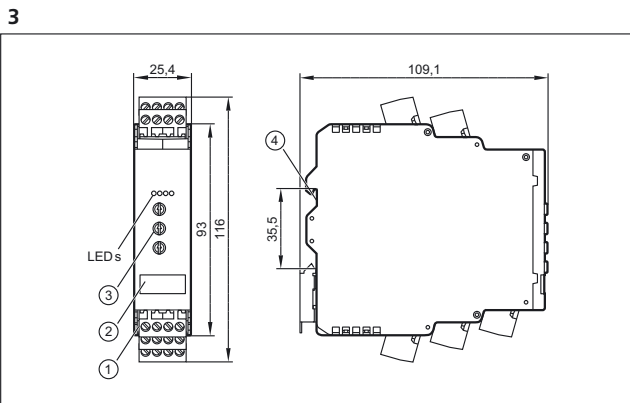

1: Combicon connector with screw terminals, 2: Mounting on DIN rail

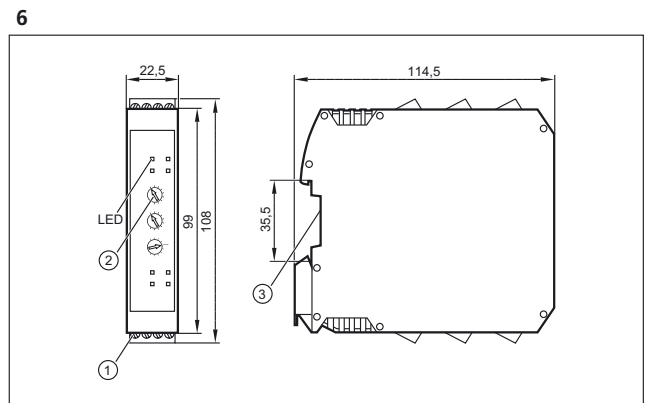

1: screw terminals, 2: Rotary switch, 3: Mounting on DIN rail

Scale drawings / drawing no. – CAD download: www.ifm.com

7

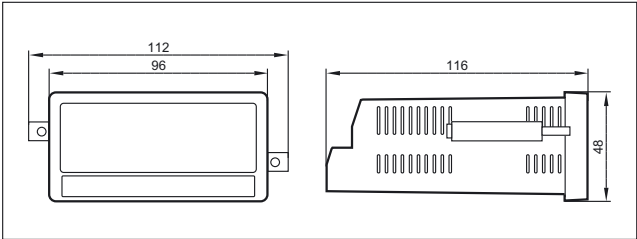

10

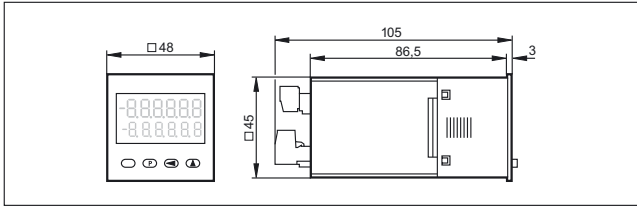

8

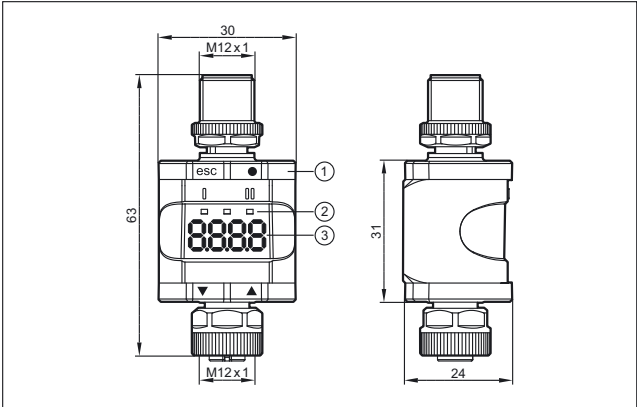

1: Push ring, 2: LEDs, 3: Display

11

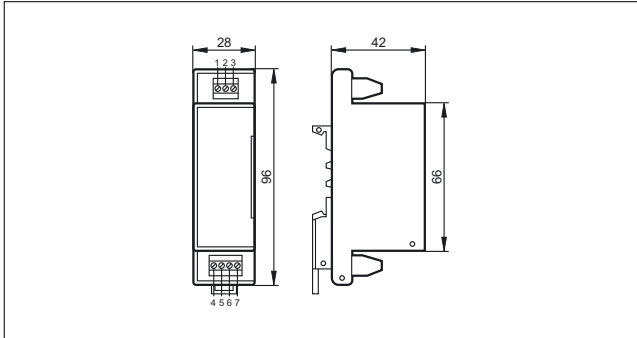

9

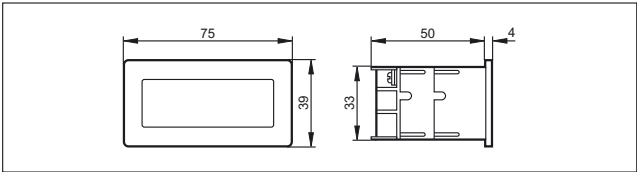

control panel cutout: 68 x 33 mm (according to DIN)

12

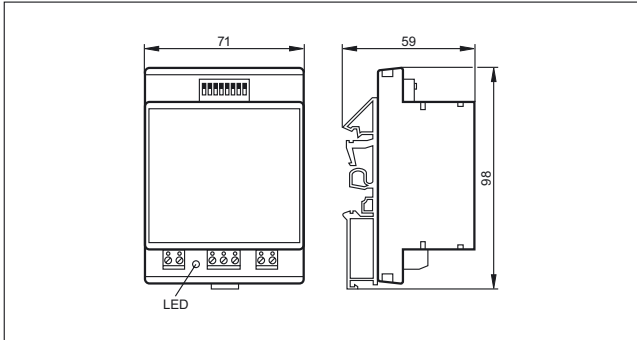



Vision sensors recognise everything at a glance



The power of a camera system with the simplicity of a sensor

In automation technology, vision sensors are nowadays not only an integral part of assembly, production and quality control, but also a means to increase efficiency. Vision sensors are cameras with application-specific evaluation, i.e. reliable electronic eyes at a low cost and a high degree of integration.

A few years ago, high-price camera systems were needed. Due to technical developments and continuously falling prices for components, ever more intelligent functions could be implemented at low cost in an ever smaller space. Not only do compact vision sensors replace camera systems, but they also offer additional application options. They are, for example, used to detect objects that have variable positions or shapes, replacing complex proximity sensors or multiple sensor solutions such as sensor bridges used for completeness checks of pallets or crates.





Easy to integrate

One of the distinguishing features of vision sensors is their simplicity. This means that they can be used without any specific prior knowledge. All units have switching outputs to confirm pass/fail conditions. So vision sensors offer the same ease of use as binary sensors. Ready-to-use function blocks support the integration into the PLC. An Ethernet process interface is used for data transmission, parameter setting and remote maintenance.

Robust and compact

Another advantage: the high protection ratings and wide temperature ranges of ifm vision sensors make it possible to install them close to the objects to be monitored. In contrast to complex camera solutions, all necessary components such as lighting, optics, evaluation electronics and output logic are integrated in the industrial housing.

With ifm vision sensors, tasks such as quality and completeness checks can now be solved easily and at a low cost.

	Vision sensors	382 - 386
	3D sensors	388 - 390
	3D cameras	392 - 395
	Illumination	396 - 400



Industrial imaging



Vision sensors

Stand-alone unit with integrated lighting and evaluation in a robust, industrially compatible housing.

The electronic eye for monitoring presence, completeness, position, quality control as well as sorting tasks.

System overview	Page
Sensors for object recognition	382 - 383
Software for vision sensors	383
Panel PC for vision sensors	384
Fixing components for vision sensors	384 - 385
Reflective tapes, diffusers and protective panes for vision sensors	385
Scale drawings / drawing no. – CAD download: www.ifm.com	386

Sensors for object recognition

Type	Operating principle	Max. field of view size [mm]	Resolution [mm]	Detection rate [Hz]	Type of light	Ambient temperature [°C]	Drawing no.	Order no.
------	---------------------	---------------------------------	--------------------	------------------------	---------------	-----------------------------	-------------	-----------

Type O2V · M12 plug, 8 poles · M12 socket, 4 poles · metal · DC · PNP · Connector groups 16, 17, 157, 183

	CMOS image sensor B/W, VGA resolution 640 x 480	640 x 480	1.0	10	White light	-10...60	1	O2V100
	CMOS image sensor B/W, VGA resolution 640 x 480	640 x 480	1.0	10	Infrared	-10...60	1	O2V120
	CMOS image sensor B/W, VGA resolution 640 x 480	1320 x 945	2.0	10	White light	-10...60	1	O2V102
	CMOS image sensor B/W, VGA resolution 640 x 480	1320 x 945	2.0	10	Infrared	-10...60	1	O2V122
	CMOS image sensor B/W, VGA resolution 640 x 480	400 x 300	0.633	10	White light	-10...60	2	O2V104
	CMOS image sensor B/W, VGA resolution 640 x 480	400 x 300	0.633	10	Infrared	-10...60	2	O2V124



Type O2V · M12 plug, 8 poles · M12 socket, 4 poles · metal · DC · NPN · Connector groups 16, 17, 157, 183

	CMOS image sensor B/W, VGA resolution 640 x 480	640 x 480	1.0	10	White light	-10...60	1	O2V101
--	---	-----------	-----	----	-------------	----------	---	---------------



Product selectors and further information can be found at: www.ifm.com

Type	Operating principle	Max. field of view size [mm]	Resolution [mm]	Detection rate [Hz]	Type of light	Ambient temperature [°C]	Draw- ing no.	Order no.
------	---------------------	---------------------------------	--------------------	------------------------	---------------	-----------------------------	---------------------	--------------



Type O2V · M12 plug, 8 poles · M12 socket, 4 poles · metal · DC · NPN · Connector groups 16, 17, 157, 183

	CMOS image sensor B/W, VGA resolution 640 x 480	640 x 480	1.0	10	Infrared	-10...60	1	O2V121
	CMOS image sensor B/W, VGA resolution 640 x 480	1320 x 945	2.0	10	White light	-10...60	1	O2V103
	CMOS image sensor B/W, VGA resolution 640 x 480	1320 x 945	2.0	10	Infrared	-10...60	1	O2V123
	CMOS image sensor B/W, VGA resolution 640 x 480	400 x 300	0.633	10	White light	-10...60	2	O2V105
	CMOS image sensor B/W, VGA resolution 640 x 480	400 x 300	0.633	10	Infrared	-10...60	2	O2V125

Type O2D2 · M12 plug, 8 poles · M12 socket, 4 poles · metal · DC · PNP · Connector groups 16, 17, 157, 183

	CMOS image sensor B/W, VGA resolution 640 x 480	400 x 300	0.633	10	Infrared	-10...60	2	O2D224
	CMOS image sensor B/W, VGA resolution 640 x 480	640 x 480	1.0	10	Infrared	-10...60	1	O2D220
	CMOS image sensor B/W, VGA resolution 640 x 480	1320 x 945	2.0	10	Infrared	-10...60	1	O2D222

Type O2D2 · M12 plug, 8 poles · M12 socket, 4 poles · metal · DC · NPN · Connector groups 16, 17, 157, 183



	CMOS image sensor B/W, VGA resolution 640 x 480	400 x 300	0.633	10	Infrared	-10...60	2	O2D225
	CMOS image sensor B/W, VGA resolution 640 x 480	640 x 480	1.0	10	Infrared	-10...60	1	O2D227
	CMOS image sensor B/W, VGA resolution 640 x 480	1320 x 945	2.0	10	Infrared	-10...60	1	O2D229

Software for vision sensors





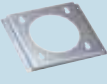



Type	Description	Order no.
	Operating software · O2D	E2D200
	Operating software · O2V	E2V100







Panel PC for vision sensors

Type	Description	Order no.
	Touch Panel PC · 12.1" colour display · Intel Atom CPU 1.6 GHz · 2 GByte RAM · Windows Embedded Standard 7 SP1 (32 bits)	E2D400
	Mounting bracket · for Touch Panel PC · for wall mounting · VESA standard 100 x 100 mm · Housing materials: fixture: metal	E2D401
	Mounting set · for Touch Panel PC · for control cabinet mounting · Housing materials: fixture: metal / End cap: plastics	E2D402

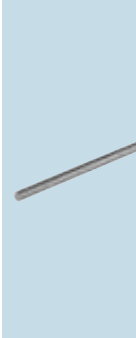
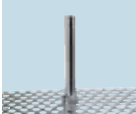
Fixing components for vision sensors

Type	Description	Order no.
	Mounting set · O2D, O2M, O2I, O2V · Clamp mounting · rod mounting Ø 12 mm · Housing materials: fixture: stainless steel / clamp: stainless steel	E2D110
	Mounting set · O2D, O2M, O2I, O2V · Clamp mounting · rod mounting Ø 14 mm · Housing materials: fixture: stainless steel / clamp: stainless steel	E2D112
	Mounting set · Backlight 50 x 50 mm · Clamp mounting · Housing materials: Mounting plate: stainless steel / clamp: high-grade stainless steel	E2D108
	Mounting set · Backlight 100 x 100 mm · Clamp mounting · Housing materials: Mounting plate: stainless steel / clamp: high-grade stainless steel	E2D109
	clamp · Ø 12 mm · rod mounting Ø 12 mm · Housing materials: clamp: stainless steel	E21110
	clamp · Ø 14 mm · rod mounting Ø 14 mm · Housing materials: clamp: stainless steel	E21109
	clamp · Ø 12 mm; M10 · Free-standing M10 · Housing materials: clamp: stainless steel	E20946
	clamp · Ø 14 mm; M12 · free-standing M12 · Housing materials: clamp: stainless steel	E20948
	mounting rod · Ø 12 / M10 · Length: 130 mm · straight · Housing materials: stainless steel 316Ti / 1.4571	E20938
	mounting rod · Ø 12 / M10 · Length: 200 mm · angled · Housing materials: stainless steel 316Ti / 1.4571	E20940

Type	Description	Order no.
	mounting rod · Ø 12 · Length: 150 mm · straight · Housing materials: stainless steel 316Ti / 1.4571	E21111
	mounting rod · Ø 12 · Length: 200 mm · straight · Housing materials: stainless steel 316Ti / 1.4571	E21112
	mounting rod · Ø 12 · Length: 300 mm · straight · Housing materials: stainless steel 316Ti / 1.4571	E21113
	mounting rod · Ø 14 / M12 · Length: 130 mm · straight · Housing materials: stainless steel 316Ti / 1.4571	E20939
	mounting rod · Ø 14 / M12 · Length: 200 mm · angled · Housing materials: stainless steel 316Ti / 1.4571	E20941
	Connection piece · Ø 20 mm · for the connection of two clamps with Ø 20 mm · Housing materials: stainless steel 316L / 1.4404	E21076
	Cube · M10 · aluminium profile · Housing materials: diecast zinc	E20951
	Cube · M12 · aluminium profile · Housing materials: diecast zinc	E20952

Reflective tapes, diffusers and protective panes for vision sensors

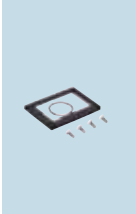
Type	Description	Order no.
	Reflective tape · TS-00 · 50 x 1000 mm · for redlight and infrared light retro-reflective sensors without polarisation filter · Housing materials: plastics	E20401
	Reflective tape · TS-02 · 50 x 1000 mm · For red light and infrared light retro-reflective sensors · Housing materials: plastics / acrylic	E21015
	Plastic diffuser · O2D / O2I · Housing materials: housing: diecast zinc black / lens: PMMA	E21165
	Plastic protective pane for the food industry · O2D / O2I · Housing materials: housing: diecast zinc black / lens: PMMA	E21166
	Glass protective pane · O2D / O2I · Housing materials: housing: diecast zinc black / lens: float glass	E21168
	Daylight filter · O2D · Housing materials: housing: diecast zinc black / lens: PMMA / Metal ring: aluminium black anodised / sealing: FPM 75+/-5 Shore A black	E21172



Scale drawings / drawing no. – CAD download: www.ifm.com

1

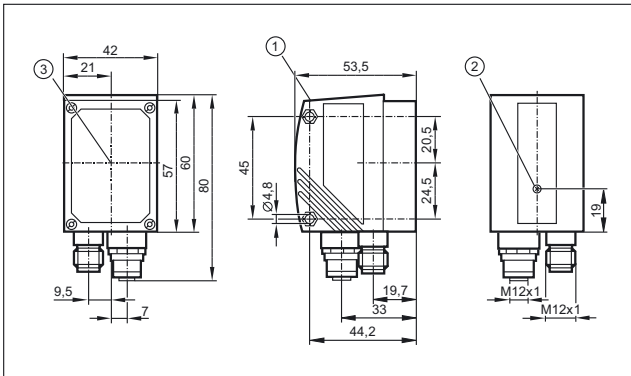

1: display, 2: Focus adjustment screw, 3: Centre of the lens axes

2

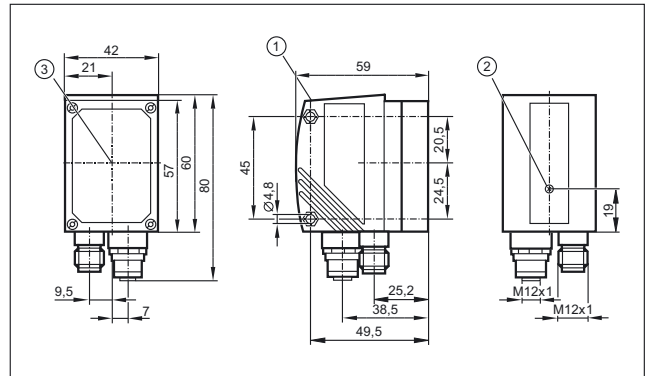

1: display, 2: Focus adjustment screw, 3: Centre of the lens axes





Industrial imaging





3D sensors

Photoelectric 3D sensors are suited for many different applications, such as volume, distance and level detection. They measure the distance between the sensor and the nearest surface point by point using the time-of-flight principle. The sensors illuminate the scene with an internal or external infrared light source and calculate the distance by means of the light reflected from the surface.

These sensors for industrial applications can be used for completeness checks, volume determination or sorting tasks. Sensors for applications in mobile machines have an outstanding shock and vibration resistance.

System overview	Page
Sensors for 3D object recognition	388
Software for 3D sensors	389
Panel PC for vision sensors	389
Fixing components for 3D sensors	389
Scale drawings / drawing no. – CAD download: www.ifm.com	390



Sensors for 3D object recognition

Type	Operating principle	Resolution (pixels)	Angle of aperture (horizontal x vertical) [°]	Lighting	Max. sampling rate [Hz]	Ambient temperature [°C]	Drawing no.	Order no.
PMD 3D sensor · Type O3D · M12 connector · metal · DC · Connector groups 16, 17, 157, 183								
	3D ToF sensor	64 x 48	30 x 40	Infrared LED	20	-10...50	1	O3D200
	3D ToF sensor	64 x 48	64 x 48	Infrared LED	20	-10...50	2	O3D222
3D sensor · Type O3D · M12 connector · metal · DC · Connector groups 16, 17								
	3D ToF sensor	176 x 132	40 x 30	Infrared LED	25	-10...50	3	O3D300
	3D ToF sensor	176 x 132	60 x 45	Infrared LED	25	-10...50	4	O3D302
3D sensor · Type O3D · M12 connector · metal · DC · Connector groups 16, 17, 157, 183								
	3D ToF sensor	176 x 132	40 x 30	Infrared LED	25	-10...50	3	O3D310
	3D ToF sensor	176 x 132	60 x 45	Infrared LED	25	-10...50	4	O3D312

Software for 3D sensors

Type	Description	Order no.
	Operating software · O3D2xx	E3D200
	Operating software · O3Mxxx · O3D3xx	E3D300

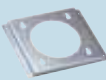
Panel PC for vision sensors

Type	Description	Order no.
	Touch Panel PC · 12.1" colour display · Intel Atom CPU 1.6 GHz · 2 GByte RAM · Windows Embedded Standard 7 SP1 (32 bits)	E2D400
	Mounting bracket · for Touch Panel PC · for wall mounting · VESA standard 100 x 100 mm · Housing materials: fixture: metal	E2D401
	Mounting set · for Touch Panel PC · for control cabinet mounting · Housing materials: fixture: metal / End cap: plastics	E2D402

Fixing components for 3D sensors

Type	Description	Order no.
	Mounting set · O3D · Clamp mounting · Type O3D · rod mounting Ø 14 mm · Housing materials: fixture: stainless steel / clamp: stainless steel	E3D103
	Mounting set · O3D · Clamp mounting · Type Smart Camera · rod mounting Ø 14 mm · Housing materials: fixture: stainless steel / clamp: stainless steel	E3D301
	mounting rod · Ø 14 / M12 · Length: 130 mm · straight · Housing materials: stainless steel 316Ti / 1.4571	E20939
	mounting rod · Ø 14 · Length: 200 mm · straight · Housing materials: stainless steel 316Ti / 1.4571	E21228
	mounting rod · Ø 14 · Length: 300 mm · straight · Housing materials: stainless steel 316Ti / 1.4571	E21229
	mounting rod · Ø 14 · Length: 500 mm · straight · Housing materials: stainless steel 316Ti / 1.4571	E21232



Industrial imaging

Scale drawings / drawing no. – CAD download: www.ifm.com

1

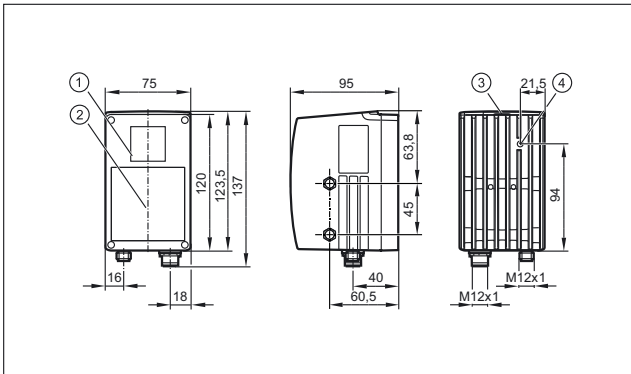

1: lens, 2: Illumination unit, 3: Display / buttons / LEDs, 4: Focus adjustment screw

3

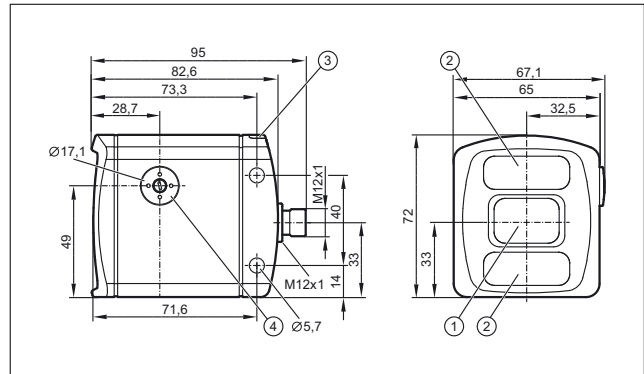

1: lens, 2: Illumination unit, 3: LED 2 colours (yellow/green), 4: Focus adjustment screw

2

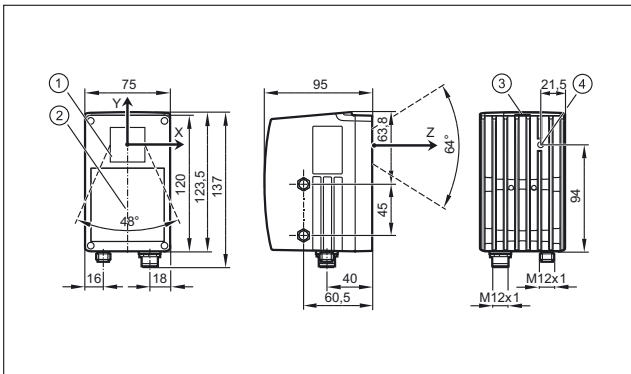

4

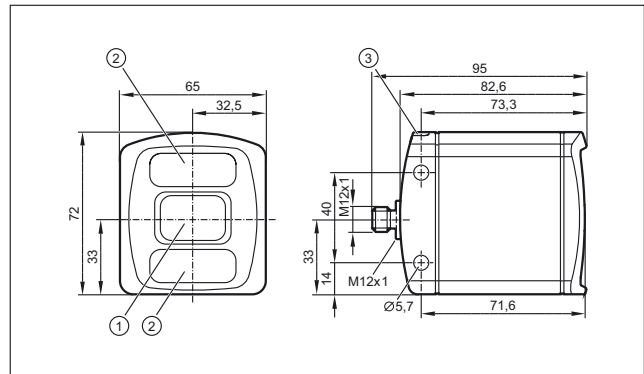

1: lens, 2: Illumination unit, 3: LED 2 colours (yellow/green)





Industrial imaging



3D cameras



The pmd 3d camera detects scenes and objects in their spatial dimensions at a glance. In contrast to laser scanners it does not require moving components and is thus robust and wear-free. The operating principle is the same as for the 3D sensor. Besides the 3D distance image the camera provides a grey image of the scene. The combination of these images offers the possibility to freely program application-specific tasks by means of a software development kit.

System overview	Page
Cameras for 3D object recognition	392
Software for 3D cameras	393
Accessories	393
Fixing components for 3D cameras	393
Connection cables for industrial imaging	394 - 395
Scale drawings / drawing no. – CAD download: www.ifm.com	395



Cameras for 3D object recognition

Type	Operating principle	Resolution (pixels)	Angle of aperture (horizontal x vertical) [°]	Lighting	Max. sampling rate [Hz]	Ambient temperature [°C]	Drawing no.	Order no.
PMD 3D camera · Type O3D · M12 connector · metal · DC · Connector groups 16, 17, 157, 183								
	3D ToF camera	64 x 48	40 x 30	Infrared LED	20	-10...50	1	O3D201
	3D ToF Kamera	64 x 48	64 x 48	Infrared LED	20	-10...50	2	O3D223
3D camera · Type O3D · M12 connector · metal · DC · Connector groups 12, 13, 22, 24, 152, 155, 186, 192, 194, 205								
	3D ToF Kamera	176 x 132	40 x 30	Infrared LED	25	-10...50	3	O3D301
	3D ToF Kamera	176 x 132	60 x 45	Infrared LED	25	-10...50	4	O3D303
3D camera · Type O3D · M12 connector · metal · DC · Connector groups 152, 155, 157, 183, 186, 192								
	3D ToF Kamera	176 x 132	40 x 30	Infrared LED	25	-10...50	3	O3D311
	3D ToF Kamera	176 x 132	60 x 45	Infrared LED	25	-10...50	4	O3D313

Software for 3D cameras

Type	Description	Order no.
	Operating software · O3D2xx	E3D201
	Operating software · O3Mxxx · O3D3xx	E3D300

Accessories

Type	Description	Order no.
	Cooling element · O3D · Cooling element · Heat conductor · Type Smart Camera · panel/surf. · Housing materials: Cooling element: AlMgSi1MgMn / Heat conductor: AlMg3	E3D302
	Cooling element · O3D · Double cooling element · Heat conductor · Type Smart Camera · panel/surf. · Housing materials: Cooling element: AlMgSi1MgMn / Heat conductor: AlMg3	E3D304
	Heat conductor · O3D · Heat conductor · Type Smart Camera · panel/surf. · Housing materials: Heat conductor: AlMg3	E3D303













Fixing components for 3D cameras

Type	Description	Order no.
	Mounting set · O3D · Clamp mounting · Type O3D · rod mounting Ø 14 mm · Housing materials: fixture: stainless steel / clamp: stainless steel	E3D103
	Mounting set · O3D · Clamp mounting · Type Smart Camera · rod mounting Ø 14 mm · Housing materials: fixture: stainless steel / clamp: stainless steel	E3D301
	mounting rod · Ø 14 / M12 · Length: 130 mm · straight · Housing materials: stainless steel 316Ti / 1.4571	E20939
	mounting rod · Ø 14 · Length: 200 mm · straight · Housing materials: stainless steel 316Ti / 1.4571	E21228
	mounting rod · Ø 14 · Length: 300 mm · straight · Housing materials: stainless steel 316Ti / 1.4571	E21229
	mounting rod · Ø 14 · Length: 500 mm · straight · Housing materials: stainless steel 316Ti / 1.4571	E21232

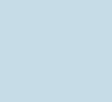

Industrial imaging

Connection cables for industrial imaging

Type	Description	Order no.
	Jumper · straight / straight · Ethernet · Cross-over patch cable · 2 m · Housing materials: PUR / PC	E11898
	Jumper · straight / straight · Ethernet · Cross-over patch cable · 2 m · Housing materials: TPU / PA	E12090
	Jumper · straight / straight · Ethernet · Gold-plated contacts · 2 m · Housing materials: TPU	E21138
	Jumper · straight / straight · Ethernet · Gold-plated contacts · 5 m · Housing materials: TPU	E21139
	Jumper · straight / straight · Ethernet · Gold-plated contacts · 10 m · Housing materials: TPU	E21137
	Jumper · straight / straight · Ethernet · 10 m · Housing materials: PUR / PC	E12204
	Jumper · straight / straight · Ethernet · 20 m · Housing materials: PUR / PC	E12205
	Socket · angled · Free from silicone · Free from halogen · Gold-plated contacts · M12 connector · 2 m · Housing materials: PUR	E11231
	Socket · angled · Free from silicone · Free from halogen · Gold-plated contacts · M12 connector · 5 m · Housing materials: PUR	E11232
	Socket · angled · Free from silicone · Free from halogen · Gold-plated contacts · M12 connector · 10 m · Housing materials: PUR	E12260
	Socket · straight · Free from halogen · M12 connector · 5 m · Housing materials: PUR	E11807
	Socket · straight · Free from halogen · M12 connector · 10 m · Housing materials: PUR	E11311
	Socket · straight · Free from halogen · M12 connector · 2 m · Housing materials: PUR	E11950
	Adapter · angled · Connector	E21140

Type	Description	Order no.
	Jumper · straight / straight · Ethernet · Cross-over patch cable · 2 m · Housing materials: PUR	EC2080
	Jumper · straight / straight · Ethernet · Cross-over patch cable · 5 m · Housing materials: PUR	E30112

Scale drawings / drawing no. – CAD download: www.ifm.com

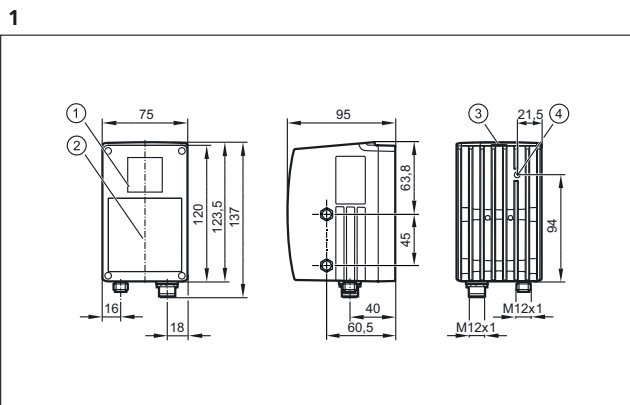

1: lens, 2: Illumination unit, 3: Display / buttons / LEDs, 4: Focus adjustment screw

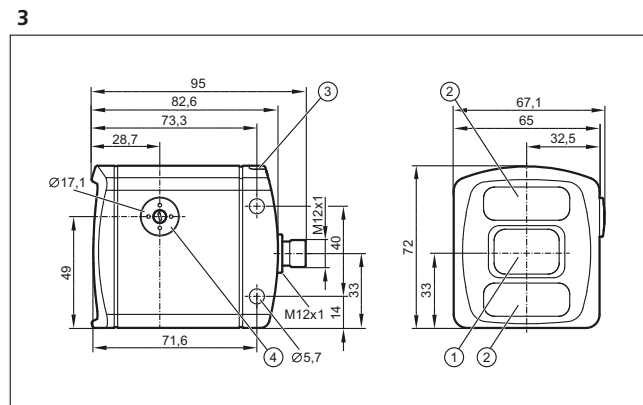

1: lens, 2: Illumination unit, 3: LED 2 colours (yellow/green), 4: Focus adjustment screw

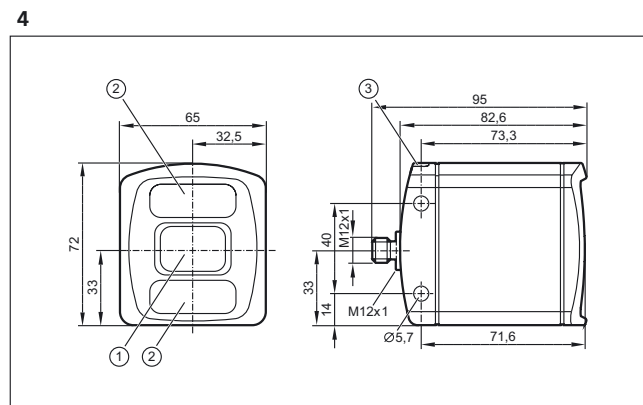
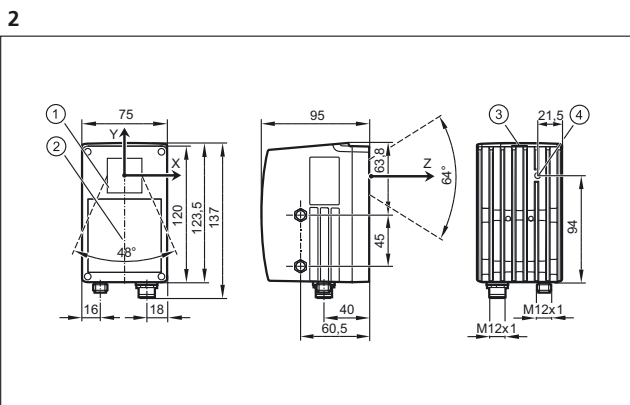

1: lens, 2: Illumination unit, 3: LED 2 colours (yellow/green)



Industrial imaging



Illumination

The lighting units generate a homogeneous light field with visible red or invisible infrared light and are available in three different sizes. They are most often used in combination with object recognition and object inspection sensors for contour and position verification. The high-quality LED illumination creates homogeneous light - either for virtually shadow-free object illumination or for emphasising surface characteristics such as dot-peened codes, scratches or nicks.







The optional angle bracket and the tried-and-tested ifm mounting system facilitate the alignment of the different types of additional illumination.

System overview	Page
Illumination units, ring	396
Illumination units, bar	397
Illumination units, dark field	397
Illumination units, backlight	397 - 398
Illumination units, spotlight	398
Accessories for illumination units	398 - 399
Wiring diagrams	399
Scale drawings / drawing no. – CAD download: www.ifm.com	399 - 400

Illumination units, ring

Type	Dimensions [mm]	Type of light	Active illuminated area [mm]	I ₀ normal light intensity [mA]	I ₀ high light intensity [mA]	Trigger	Draw- ing no.	Order no.
PUR cable with M12 connector 0.3 m · metal · DC · Wiring diagram no. 1 · Connector groups 8, 10, 19, 21, 23, 25, 148, 149, 153, 184, 188, 193, 202								
	Ø 122 / L = 20.5	Red	Ø 66 / 106	800	1300	external; 24 V PNP	1	O2D915
	Ø 122 / L = 20.5	Infrared	Ø 66 / 106	800	1400	external; 24 V PNP	1	O2D917
	Ø 122 / L = 20.5	White light	Ø 66 / 106	800	1200	external; 24 V PNP	1	O2D919



Illumination units, bar

Type	Dimensions [mm]	Type of light	Active illuminated area [mm]	I ₀ normal light intensity [mA]	I ₀ high light intensity [mA]	Trigger	Draw- ing no.	Order no.
PUR cable with M12 connector 0.3 m · metal · DC · Wiring diagram no. 1 · Connector groups 8, 10, 19, 21, 23, 25, 148, 149, 153, 184, 188, 193, 202								
	116 x 13 x 18	White light	10 x 75	165	275	external; 24 V PNP	2	O2D923
	200 x 13 x 18	White light	10 x 150	265	475	external; 24 V PNP	4	O2D926
	116 x 13 x 18	Red	10 x 75	225	375	external; 24 V PNP	2	O2D921
	200 x 13 x 18	Red	10 x 150	460	700	external; 24 V PNP	4	O2D924
	116 x 13 x 18	Infrared	10 x 75	185	325	external; 24 V PNP	2	O2D922
	200 x 13 x 18	Infrared	10 x 150	415	640	external; 24 V PNP	4	O2D925

Illumination units, dark field

Type	Dimensions [mm]	Type of light	Active illuminated area [mm]	I ₀ normal light intensity [mA]	I ₀ high light intensity [mA]	Trigger	Draw- ing no.	Order no.
PUR cable with M12 connector 0.3 m · metal · DC · Wiring diagram no. 2 · Connector groups 8, 10, 19, 21, 23, 25, 148, 149, 153, 184, 188, 193, 202								
	155 x 130 x 9.8	Red	∅ 90	–	–	external; 24 V PNP	3	O2D920



Illumination units, backlight

Type	Dimensions [mm]	Type of light	Active illuminated area [mm]	I ₀ normal light intensity [mA]	I ₀ high light intensity [mA]	Trigger	Draw- ing no.	Order no.
PUR cable 2 m · metal · DC · Wiring diagram no. 3								
	108 x 9.8 x 81	Red	50 x 50	200	100	External; 24 V PNP to IEC61131-1	5	O2D902
	108 x 9.8 x 81	Infrared	50 x 50	200	100	External; 24 V PNP to IEC61131-1	5	O2D903
	161.2 x 9.8 x 133	Red	100 x 100	450	250	External; 24 V PNP to IEC61131-1	6	O2D904



You can find wiring diagrams and scale drawings from page 399





Industrial imaging



Type	Dimensions [mm]	Type of light	Active illuminated area [mm]	I ₀ normal light intensity [mA]	I ₀ high light intensity [mA]	Trigger	Draw- ing no.	Order no.
PUR cable 2 m · metal · DC · Wiring diagram no. 3								
	161.2 x 9.8 x 133	Infrared	100 x 100	450	250	External; 24 V PNP to IEC61131-1	6	O2D905
PUR cable 0.15 m · metal · DC · Wiring diagram no. 1 · Connector groups 8, 10, 19, 21, 23, 25, 148, 149, 153, 184, 188, 193, 202								
	108 x 9.8 x 81	Red	50 x 50	200	100	External; 24 V PNP to IEC61131-1	5	O2D911
	108 x 9.8 x 81	Infrared	50 x 50	200	100	External; 24 V PNP to IEC61131-1	5	O2D907
	161.2 x 9.8 x 133	Red	100 x 100	450	250	External; 24 V PNP to IEC61131-1	6	O2D912
	161.2 x 9.8 x 133	Infrared	100 x 100	450	250	External; 24 V PNP to IEC61131-1	6	O2D908

Illumination units, spotlight

Type	Dimensions [mm]	Type of light	Active illuminated area [mm]	I ₀ normal light intensity [mA]	I ₀ high light intensity [mA]	Trigger	Draw- ing no.	Order no.
M12 connector · metal · DC · Wiring diagram no. 1 · Connector groups 8, 10, 19, 21, 23, 25, 148, 149, 153, 184, 188, 193, 202								
	42 x 42 x 31	Red	Diffuser no	180	90	External; 24 V PNP to IEC61131-1	7	O2D909
	42 x 42 x 32.2	Red	Diffuser yes	180	90	External; 24 V PNP to IEC61131-1	8	O2D913

Accessories for illumination units

Type	Description	Order no.
	Glass diffuser · Ring light · Housing materials: housing: aluminium black anodised / lens: glass	E2D202
	Mounting set · Ring light · Clamp mounting · Housing materials: Mounting bracket: stainless steel / clamp: high-grade stainless steel	E2D201
	Mounting set · Dark field light · Clamp mounting · Housing materials: Mounting bracket: stainless steel / clamp: high-grade stainless steel	E2D115

Type	Description	Order no.
	Mounting set · Clamp mounting · for 4 bar lights 10x75 mm · Housing materials: Mounting bracket: stainless steel / clamp: high-grade stainless steel	E2D116
	Mounting set · Clamp mounting · Housing materials: Mounting bracket: stainless steel / clamp: high-grade stainless steel	E2D114

Wiring diagrams

Core colours

- BK black
- BN brown
- BU blue
- WH white

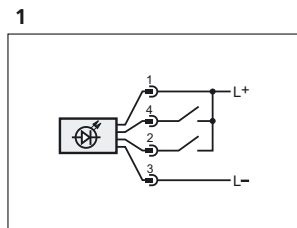

1: Trigger, 2: Operating mode "high light intensity"

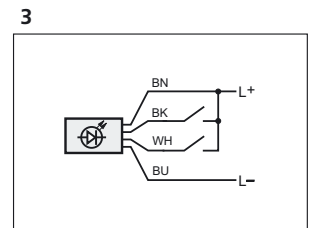
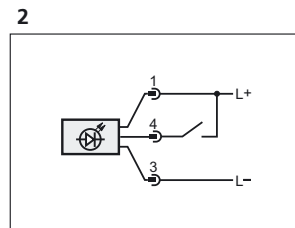

black: Trigger, white: Operating mode "high light intensity"

Scale drawings / drawing no. – CAD download: www.ifm.com

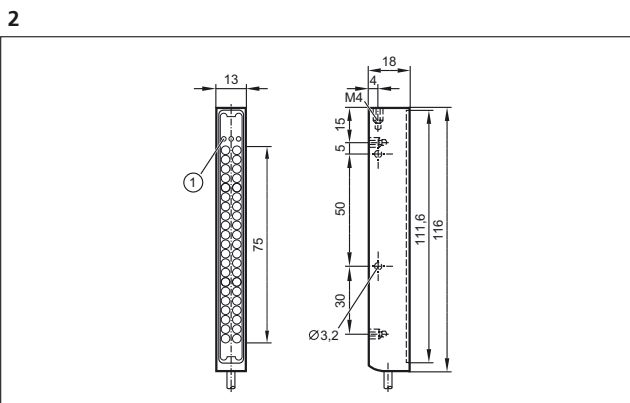
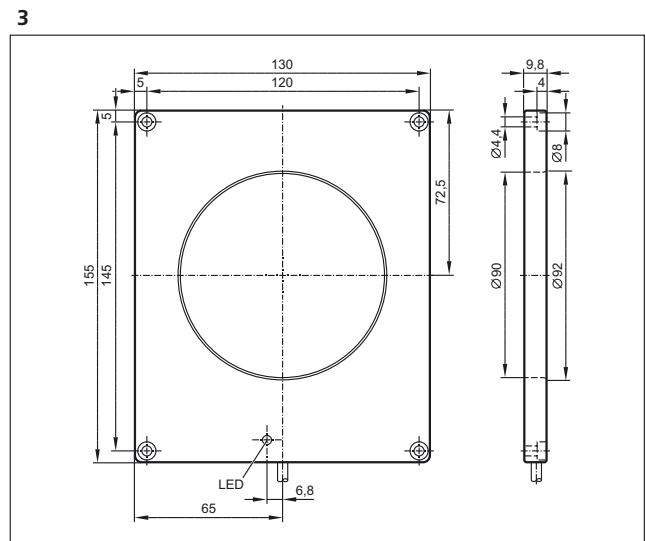
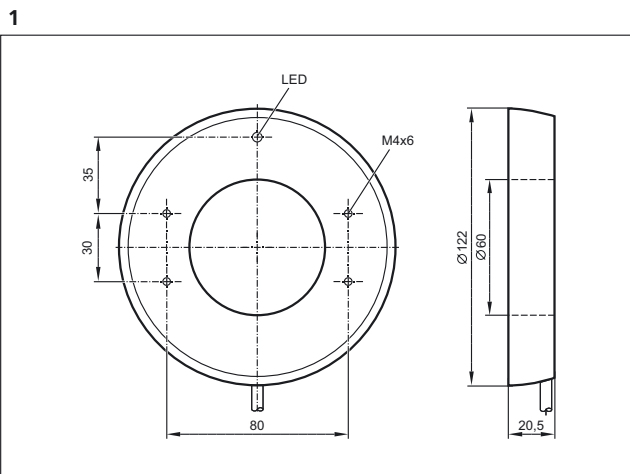

1: LED



Scale drawings / drawing no. – CAD download: www.ifm.com

4

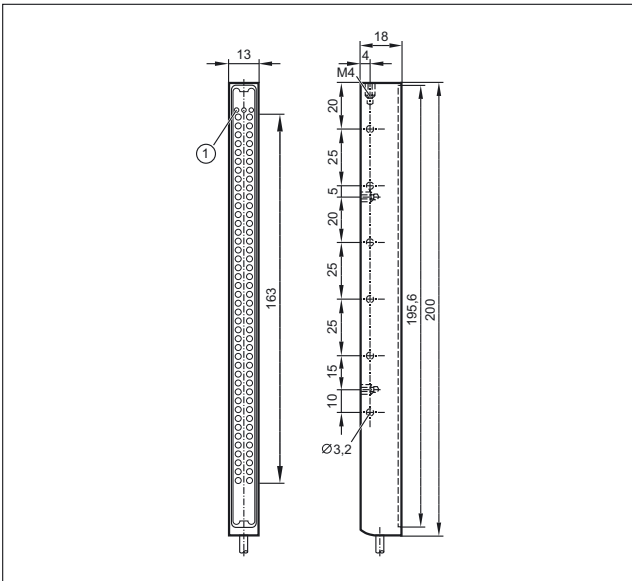

1: LED

5

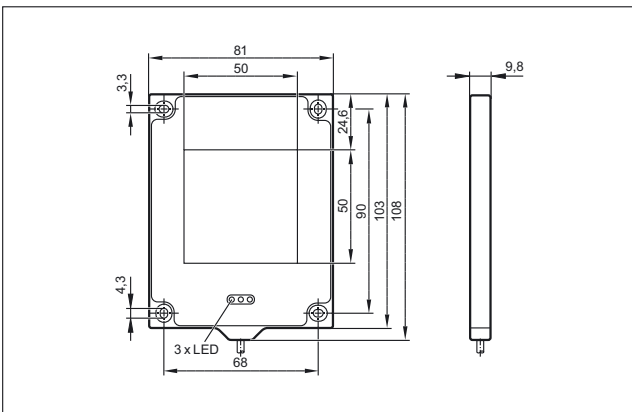

6

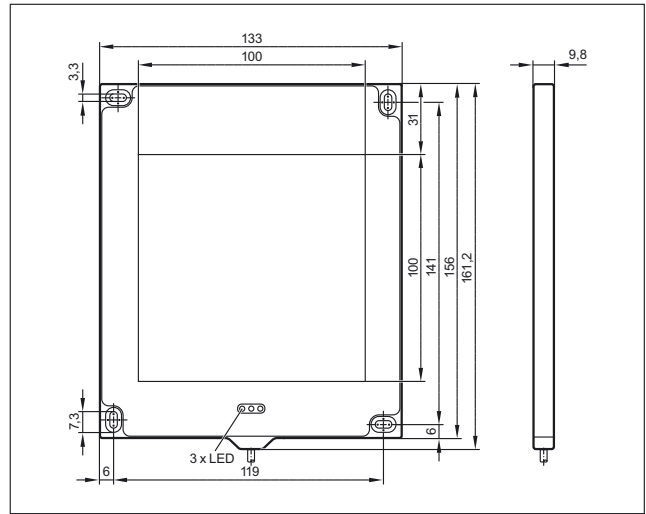

7

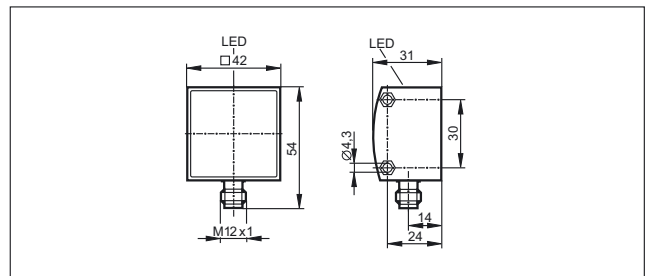

8

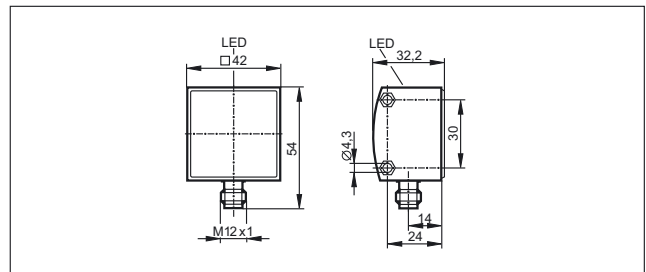





Reliable operator, process and machine protection



Applications

Today, automation technology can no longer be imagined without Functional Safety – not least because of the new EC Machinery Directive (2006/42/EC).

Its primary objective is to protect operators as stipulated by the Machinery Directive, whereby machinery should not present a risk. Moreover, safety technology is an important guarantor of process protection and, in particular, of machine protection.

Approvals







A series of standards relates to the subject of Functional Safety. They specify different Safety Integrity Levels.

- IEC 61508: This standard is regarded as the basic safety standard and classifies safety products for automation by „Safety Integrity Levels“ (SIL 1 – SIL 3).
- IEC 62061: This standard is based on IEC 61508 and determines „Safety Integrity Level Claim Limits“ (SIL CL1 – SIL CL 3). These are comparable to the Safety Integrity Levels of IEC 61508. This standard specifies the design of control systems.
- ISO 13849-1: This standard is the successor to the previously applicable standard EN 954-1. In this standard „Performance Levels“ (PL a to PL e) can be achieved. PL b-c correspond to SIL 1, PL d corresponds to SIL 2 and PL e corresponds to SIL 3. This standard covers the machinery sector.
- IEC 61496: This standard specifies general requirements for Electro-Sensitive Protective Equipment (ESPE) such as safety light grids. Variants are types 2 to 4.

Output versions

Output options include safe output stages such as OSSD outputs (Output Signal Switching Devices), outputs with a safe clock cycle that can be connected in series as well as relay outputs.

OSSD and pulsed outputs are the ideal choice for local safety-related tasks associated with controllers. Relay outputs are used to switch contactors. Moreover safe bus systems such as AS-i Safety at Work or CANopen Safety are available.

	<i>Fail-safe inductive sensors</i>	404 - 407
	<i>Safety light curtains</i>	408 - 427
	<i>Safety light grids</i>	428 - 434
	<i>Safety relays</i>	436 - 437
	<i>Safety controllers</i>	438 - 439
	<i>AS-Interface Safety at Work</i>	440 - 445



Safety technology







Fail-safe inductive sensors

Here you will find the first electronic fail-safe sensors which do not require a special counterpart but switch directly on the door or a stainless steel or mild steel target. They are wear-free and largely independent from mounting tolerances after a longer use of the doors.

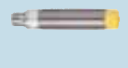
System overview	Page
Inductive sensors for safety-related applications SIL 3 and PL e with the possibility of connection in series	404
Inductive sensors for safety-related applications, 2 x OSSD, SIL 2, PL d	405
Inductive sensors for safety-related applications, 2 x OSSD, SIL 3, PL e	405
Accessories	406
Wiring diagrams	406
Scale drawings / drawing no. – CAD download: www.ifm.com	406 - 407

Inductive sensors for safety-related applications SIL 3 and PL e with the possibility of connection in series



Type	Length [mm]	Enable zone [mm]	Housing material	U _b DC [V]	Protection	Response time in case of a safety request / enable time [ms]	Drawing no.	Order no.
M12 connector · Wiring diagram no. 1 · Connector groups 148, 149, 153, 184, 188, 193, 202								
	M18 / L = 71.5	0...6.5 nf	High-grade st. steel	24	IP 65 / IP 67 / IP 69K	≤ 1 / ≤ 1	1	GG714S
M12 connector · Wiring diagram no. 3 · Connector groups 148, 149, 153, 184, 188, 193, 202								
	M18 / L = 90	3...6 nf	High-grade st. steel	24	IP 68 / IP 69K	≤ 20 / ≤ 200	2	GG505S
	M18 / L = 90.5	1...4 f	Brass	24	IP 68 / IP 69K	≤ 20 / ≤ 200	3	GG507S
	M30 / L = 80	6...12 nf	High-grade st. steel	24	IP 68 / IP 69K	≤ 20 / ≤ 200	4	GI505S
	40 x 40 x 66	10...15 nf	PPE	24	IP 65 / IP 67	≤ 20 / ≤ 200	5	GM504S
	40 x 40 x 66	10...20 nf	PPE	24	IP 65 / IP 67	≤ 20 / ≤ 200	5	GM505S

f = flush / nf = non flush / qf = quasi-flush

Inductive sensors for safety-related applications, 2 x OSSD, SIL 2, PL d

Type	Length [mm]	Enable zone [mm]	Housing material	U _b DC [V]	Protection	Response time in case of a safety request / enable time [ms]	Drawing no.	Order no.
------	----------------	---------------------	------------------	-----------------------------	------------	---	-------------	-----------



M12 connector · Wiring diagram no. 1 · Connector groups 148, 149, 153, 184, 188, 193, 202

	M12 / L = 70	0.5...4 nf	High-grade st. steel	24	IP 65 / IP 67	≤ 1 / ≤ 1	6	GF711S
	M18 / L = 70.5	1...8 nf	High-grade st. steel	24	IP 65 / IP 67	≤ 1 / ≤ 1	7	GG711S
	M18 / L = 70	1...5 f	Brass	24	IP 65 / IP 67	≤ 1 / ≤ 1	8	GG712S

M12 connector · Wiring diagram no. 2 · Connector groups 148, 149, 153, 184, 188, 193, 202

	M18 / L = 86.5	> 10 f	Brass	24	IP 65 / IP 67	≤ 5 / ≤ 5	9	GG851S
---	-------------------	--------	-------	----	---------------	-----------	---	--------

M12 connector · Wiring diagram no. 1 · Connector groups 148, 149, 153, 184, 188, 193, 202



	M30 / L = 70	1...15 nf	High-grade st. steel	24	IP 65 / IP 67	≤ 10 / ≤ 1	10	GI711S
	M30 / L = 70	1...10 f	High-grade st. steel	24	IP 65 / IP 67	≤ 10 / ≤ 1	11	GI712S

f = flush / nf = non flush / qf = quasi-flush

Inductive sensors for safety-related applications, 2 x OSSD, SIL 3, PL e

Type	Length [mm]	Enable zone [mm]	Housing material	U _b DC [V]	Protection	Response time in case of a safety request / enable time [ms]	Drawing no.	Order no.
------	----------------	---------------------	------------------	-----------------------------	------------	---	-------------	-----------

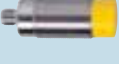
M12 connector · Wiring diagram no. 1 · Connector groups 148, 149, 153, 184, 188, 193, 202

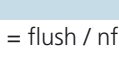
	M30 / L = 80	6...12 nf	High-grade st. steel	24	IP 68 / IP 69K	≤ 50 / ≤ 200	4	GI701S
	40 x 40 x 66	10...15 nf	PPE	24	IP 65 / IP 67	≤ 50 / ≤ 200	5	GM701S
	40 x 40 x 66	4...20 nf	PPE	24	IP 65 / IP 67	≤ 50 / ≤ 200	5	GM705S

f = flush / nf = non flush / qf = quasi-flush



Accessories

Type	Description	Order no.
	Safety T-splitter · M12 socket - 1 M12 connector / 1 M12 socket · T-piece for the pseudo-serial connection of fail-safe sensors · Housing materials: PUR	E11569

Wiring diagrams

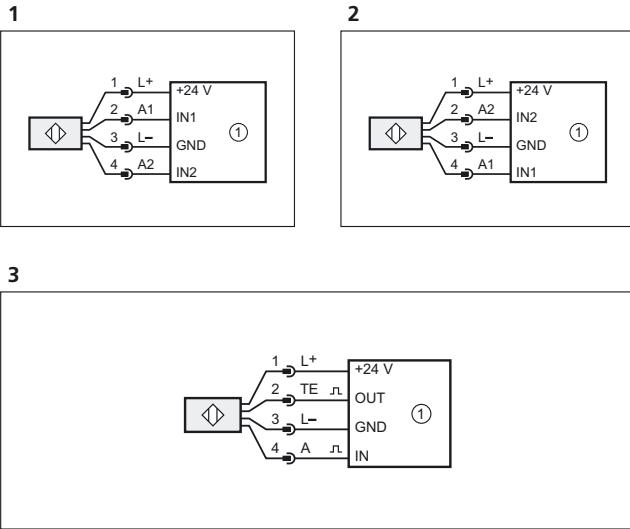

Scale drawings / drawing no. – CAD download: www.ifm.com

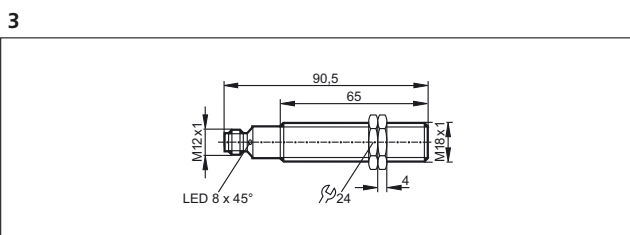
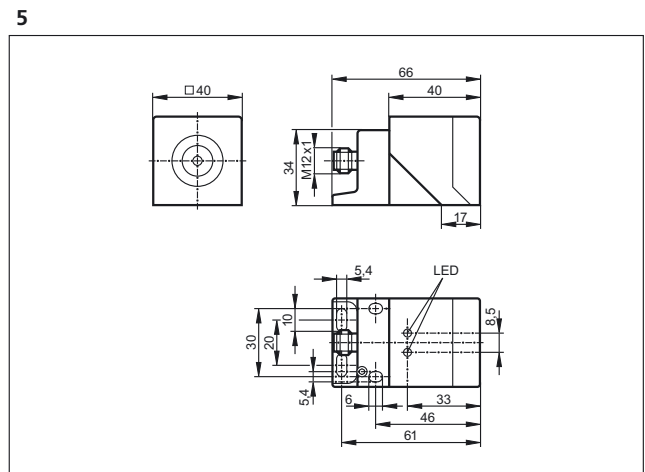
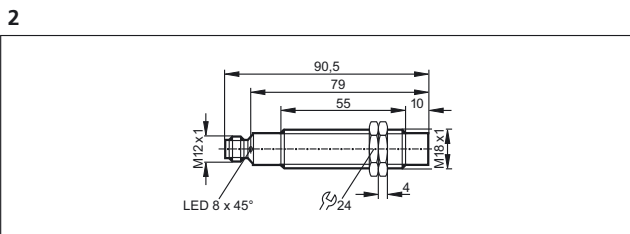
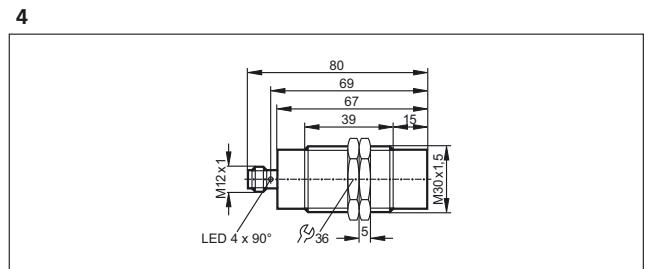
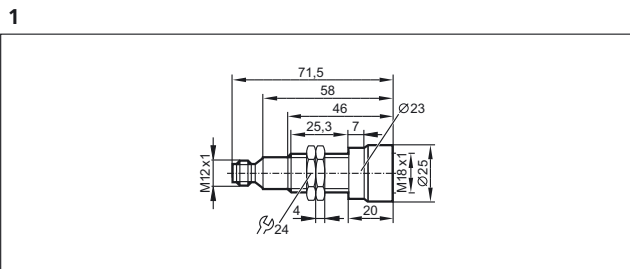

Scale drawings / drawing no. – CAD download: www.ifm.com

6

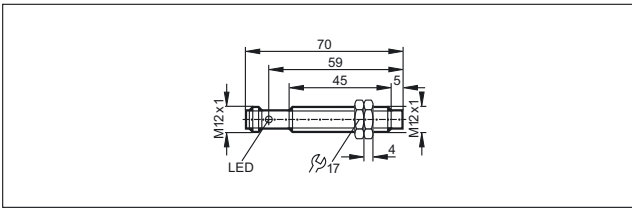

7

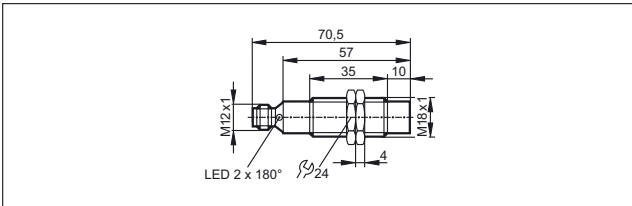

8

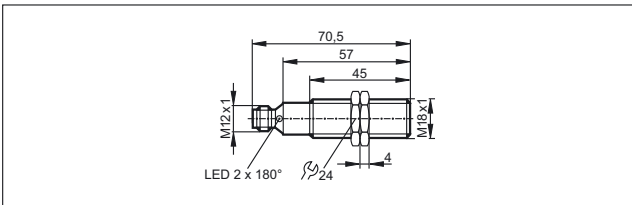

9

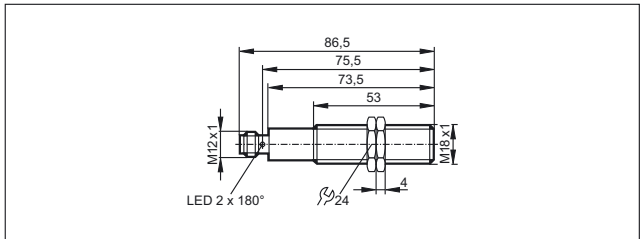

10

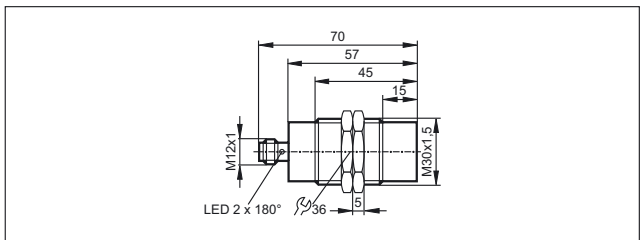

11

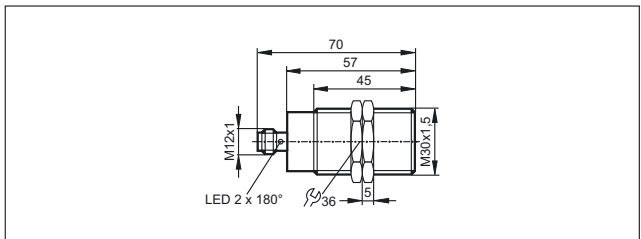



Safety technology



Safety light curtains

Wherever motion of machine parts presents a danger to people or goods, safety light curtains or safety light grids are used.

The protective equipment ensures that the outputs are switched off which results in a machine halt.

System overview	Page
Safety light curtains type 4, SIL 3, PL e, resolution 14 mm, protected area width up to 6 m	409
Safety light curtains type 4, SIL 3, PL e, resolution 20 mm, protected area width up to 20 m	410
Safety light curtains type 4, SIL 3, PL e, resolution 30 mm, protected area width up to 12 m	410 - 411
Safety light curtains type 4, SIL 3, PL e, resolution 30 mm, protected area width up to 20 m	411 - 412
Safety light curtains type 4, SIL 3, PL e, resolution 40 mm, protected area width up to 12 m	412
Safety light curtains type 4, SIL 3, PL e, resolution 40 mm, protected area width up to 20 m	413
Safety light curtains type 4, SIL 3, PL e, resolution 50 mm, protected area width up to 12 m	413 - 414
Safety light curtains type 4, SIL 3, PL e, resolution 50 mm, protected area width up to 20 m	414 - 415
Safety light curtains type 4, SIL 3, PL e, resolution 90 mm, protected area width up to 12 m	415
Safety light curtains type 4, SIL 3, PL e, resolution 90 mm, protected area width up to 20 m	415 - 416
Safety light curtains type 2, SIL 1, PL c, resolution 30 mm, protected area width up to 12 m	416 - 417
Safety light curtains type 2, SIL 1, PL c, resolution 40 mm, protected area width up to 12 m	417
Safety light curtains type 2, SIL 1, PL c, protected area width up to 12 m	418
Safety light curtains type 2, SIL 1, PL c, resolution 90 mm, protected area width up to 12 m	418 - 419
Safety light curtains for hygienic and wet areas, IP 69K, type 4, SIL 3, PL e, resolution 14 mm, protected area width up to 5 m	419
Safety light curtains for hygienic and wet areas, IP 69K, type 4, SIL 3, PL e, resolution 30 mm, protected area width up to 15 m	419 - 420
Safety light curtains for hygienic and wet areas, IP 69K, type 2, SIL 1, PL c, resolution 30 mm, protected area width up to 10 m	420 - 421
Safety light curtains with floating blanking type 4, SIL 3, PL e, resolution 14 mm, protected area width up to 5 m	421
Safety light curtains with floating blanking type 4, SIL 3, PL e, resolution 20 mm, protected area width up to 18 m	421 - 422
Safety light curtains with floating blanking type 4, SIL 3, PL e, resolution 40 mm, protected area width up to 18 m	422
Accessories for safety light curtains	422 - 424
Bases for safety light curtains	424
Bases for safety light curtains with corner mirror	424
Accessories necessary for bases	425

System overview	Page
Wiring diagrams	425
Scale drawings / drawing no. – CAD download: www.ifm.com	426 - 427

Safety light curtains type 4, SIL 3, PL e, resolution 14 mm, protected area width up to 6 m

Type	Sensor length [mm]	Resolution / detection capacity [mm]	Protected area height [mm]	Protected area width [m]	Response time [ms]	U _b [V]	Draw- ing no.	Order no.
------	-----------------------	--	----------------------------------	--------------------------------	--------------------------	-----------------------	---------------------	--------------

M12 connector · Wiring diagram no. 1, 2 · Connector groups 16, 17

	213	14	160	0...3 / 1...6	4	24	1	OY001S
	363	14	310	0...3 / 1...6	5.5	24	1	OY002S
	513	14	460	0...3 / 1...6	7.5	24	1	OY003S
	663	14	610	0...3 / 1...6	9	24	1	OY004S
	813	14	760	0...3 / 1...6	11	24	1	OY005S
	963	14	910	0...3 / 1...6	13	24	1	OY006S
	1113	14	1060	0...3 / 1...6	14.5	24	1	OY007S
	1263	14	1210	0...3 / 1...6	16.5	24	1	OY008S
	1413	14	1360	0...3 / 1...6	18	24	1	OY009S
	1563	14	1510	0...3 / 1...6	20	24	1	OY010S
	1863	14	1810	0...3 / 1...6	20	24	1	OY011S



Safety technology

Safety light curtains type 4, SIL 3, PL e, resolution 20 mm, protected area width up to 20 m

Type	Sensor length [mm]	Resolution / detection capacity [mm]	Protected area height [mm]	Protected area width [m]	Response time [ms]	U _b [V]	Draw- ing no.	Order no.
	213	20	160	0...10 / 3...20	4	24	1	OY221S
	363	20	310	0...10 / 3...20	5.5	24	1	OY222S
	513	20	460	0...10 / 3...20	7.5	24	1	OY223S
	663	20	610	0...10 / 3...20	9	24	1	OY224S
	813	20	760	0...10 / 3...20	11	24	1	OY225S
	963	20	910	0...10 / 3...20	13	24	1	OY226S
	1113	20	1060	0...10 / 3...20	14.5	24	1	OY227S
	1263	20	1210	0...10 / 3...20	16.5	24	1	OY228S
	1413	20	1360	0...10 / 3...20	18	24	1	OY229S
	1563	20	1510	0...10 / 3...20	20	24	1	OY230S

Safety light curtains type 4, SIL 3, PL e, resolution 30 mm, protected area width up to 12 m

Type	Sensor length [mm]	Resolution / detection capacity [mm]	Protected area height [mm]	Protected area width [m]	Response time [ms]	U _b [V]	Draw- ing no.	Order no.
	213	30	160	0...4 / 3...12	4	24	2	OY041S
	363	30	310	0...4 / 3...12	5.5	24	2	OY042S
	513	30	460	0...4 / 3...12	7.5	24	2	OY043S

M12 connector · Wiring diagram no. 1, 2 · Connector groups 16, 17

Type	Sensor length [mm]	Resolution / detection capacity [mm]	Protected area height [mm]	Protected area width [m]	Response time [ms]	U _b [V]	Drawing no.	Order no.
------	-----------------------	--	----------------------------------	--------------------------------	--------------------------	-----------------------	----------------	--------------

M12 connector · Wiring diagram no. 1, 2 · Connector groups 16, 17

	663	30	610	0...4 / 3...12	8.5	24	2	OY044S
	813	30	760	0...4 / 3...12	10.5	24	2	OY045S
	963	30	910	0...4 / 3...12	12	24	2	OY046S
	1113	30	1060	0...4 / 3...12	14	24	2	OY047S
	1263	30	1210	0...4 / 3...12	15.5	24	2	OY048S
	1413	30	1360	0...4 / 3...12	17	24	2	OY049S
	1563	30	1510	0...4 / 3...12	18.5	24	2	OY050S

Safety light curtains type 4, SIL 3, PL e, resolution 30 mm, protected area width up to 20 m

Type	Sensor length [mm]	Resolution / detection capacity [mm]	Protected area height [mm]	Protected area width [m]	Response time [ms]	U _b [V]	Drawing no.	Order no.
------	-----------------------	--	----------------------------------	--------------------------------	--------------------------	-----------------------	----------------	--------------

M12 connector · Wiring diagram no. 1, 2 · Connector groups 16, 17

	213	30	160	0...10 / 3...20	3	24	1	OY241S
	363	30	310	0...10 / 3...20	4	24	1	OY242S
	513	30	460	0...10 / 3...20	5	24	1	OY243S
	663	30	610	0...10 / 3...20	6	24	1	OY244S
	813	30	760	0...10 / 3...20	6.5	24	1	OY245S
	963	30	910	0...10 / 3...20	7.5	24	1	OY246S
	1113	30	1060	0...10 / 3...20	8.5	24	1	OY247S



Safety technology

Type	Sensor length [mm]	Resolution / detection capacity [mm]	Protected area height [mm]	Protected area width [m]	Response time [ms]	U _b [V]	Draw- ing no.	Order no.
------	-----------------------	--	----------------------------------	--------------------------------	--------------------------	-----------------------	---------------------	--------------

M12 connector · Wiring diagram no. 1, 2 · Connector groups 16, 17

	1263	30	1210	0...10 / 3...20	9.5	24	1	OY248S
	1413	30	1360	0...10 / 3...20	10	24	1	OY249S
	1563	30	1510	0...10 / 3...20	11	24	1	OY250S

Safety light curtains type 4, SIL 3, PL e, resolution 40 mm, protected area width up to 12 m

Type	Sensor length [mm]	Resolution / detection capacity [mm]	Protected area height [mm]	Protected area width [m]	Response time [ms]	U _b [V]	Draw- ing no.	Order no.
------	-----------------------	--	----------------------------------	--------------------------------	--------------------------	-----------------------	---------------------	--------------

M12 connector · Wiring diagram no. 1, 2 · Connector groups 16, 17

	213	40	160	0...4 / 3...12	3.5	24	2	OY061S
	363	40	310	0...4 / 3...12	4.5	24	2	OY062S
	513	40	460	0...4 / 3...12	5.5	24	2	OY063S
	663	40	610	0...4 / 3...12	6.5	24	2	OY064S
	813	40	760	0...4 / 3...12	7.5	24	2	OY065S
	963	40	910	0...4 / 3...12	9	24	2	OY066S
	1113	40	1060	0...4 / 3...12	10	24	2	OY067S
	1263	40	1210	0...4 / 3...12	11	24	2	OY068S
	1413	40	1360	0...4 / 3...12	12	24	2	OY069S
	1563	40	1510	0...4 / 3...12	13	24	2	OY070S

Safety light curtains type 4, SIL 3, PL e, resolution 40 mm, protected area width up to 20 m

Type	Sensor length [mm]	Resolution / detection capacity [mm]	Protected area height [mm]	Protected area width [m]	Response time [ms]	U _b [V]	Draw- ing no.	Order no.
------	-----------------------	--	----------------------------------	--------------------------------	--------------------------	-----------------------	---------------------	--------------

M12 connector · Wiring diagram no. 1, 2 · Connector groups 16, 17

	213	40	160	0...10 / 3...20	3	24	1	OY261S
	363	40	310	0...10 / 3...20	3.5	24	1	OY262S
	513	40	460	0...10 / 3...20	4	24	1	OY263S
	663	40	610	0...10 / 3...20	4.5	24	1	OY264S
	813	40	760	0...10 / 3...20	5	24	1	OY265S
	963	40	910	0...10 / 3...20	6	24	1	OY266S
	1113	40	1060	0...10 / 3...20	6.5	24	1	OY267S
	1263	40	1210	0...10 / 3...20	7	24	1	OY268S
	1413	40	1360	0...10 / 3...20	7.5	24	1	OY269S
	1563	40	1510	0...10 / 3...20	8	24	1	OY270S

Safety light curtains type 4, SIL 3, PL e, resolution 50 mm, protected area width up to 12 m

Type	Sensor length [mm]	Resolution / detection capacity [mm]	Protected area height [mm]	Protected area width [m]	Response time [ms]	U _b [V]	Draw- ing no.	Order no.
------	-----------------------	--	----------------------------------	--------------------------------	--------------------------	-----------------------	---------------------	--------------

M12 connector · Wiring diagram no. 1, 2 · Connector groups 16, 17

	363	50	310	0...4 / 3...12	4	24	2	OY082S
	513	50	460	0...4 / 3...12	4.5	24	2	OY083S
	663	50	610	0...4 / 3...12	5.5	24	2	OY084S



Safety technology

Type	Sensor length [mm]	Resolution / detection capacity [mm]	Protected area height [mm]	Protected area width [m]	Response time [ms]	U _b [V]	Draw- ing no.	Order no.
M12 connector · Wiring diagram no. 1, 2 · Connector groups 16, 17								
	813	50	760	0...4 / 3...12	6.5	24	2	OY0855
	963	50	910	0...4 / 3...12	7.5	24	2	OY0865
	1113	50	1060	0...4 / 3...12	8.5	24	2	OY0875
	1263	50	1210	0...4 / 3...12	9	24	2	OY0885
	1413	50	1360	0...4 / 3...12	10	24	2	OY0895
	1563	50	1510	0...4 / 3...12	11	24	2	OY0905

Safety light curtains type 4, SIL 3, PL e, resolution 50 mm, protected area width up to 20 m

Type	Sensor length [mm]	Resolution / detection capacity [mm]	Protected area height [mm]	Protected area width [m]	Response time [ms]	U _b [V]	Draw- ing no.	Order no.
M12 connector · Wiring diagram no. 1, 2 · Connector groups 16, 17								
	363	50	310	0...10 / 3...20	3	24	1	OY2825
	513	50	460	0...10 / 3...20	3.5	24	1	OY2835
	663	50	610	0...10 / 3...20	4	24	1	OY2845
	813	50	760	0...10 / 3...20	4.5	24	1	OY2855
	963	50	910	0...10 / 3...20	5	24	1	OY2865
	1113	50	1060	0...10 / 3...20	5.5	24	1	OY2875
	1263	50	1210	0...10 / 3...20	6	24	1	OY2885
	1413	50	1360	0...10 / 3...20	6.5	24	1	OY2895

Type	Sensor length [mm]	Resolution / detection capacity [mm]	Protected area height [mm]	Protected area width [m]	Response time [ms]	U _b [V]	Draw- ing no.	Order no.
------	-----------------------	--	----------------------------------	--------------------------------	--------------------------	-----------------------	---------------------	--------------

M12 connector · Wiring diagram no. 1, 2 · Connector groups 16, 17

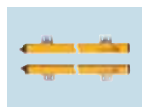

1563	50	1510	0...10 / 3...20	7	24	1	OY290S
------	----	------	-----------------	---	----	---	--------

Safety light curtains type 4, SIL 3, PL e, resolution 90 mm, protected area width up to 12 m

Type	Sensor length [mm]	Resolution / detection capacity [mm]	Protected area height [mm]	Protected area width [m]	Response time [ms]	U _b [V]	Draw- ing no.	Order no.
------	-----------------------	--	----------------------------------	--------------------------------	--------------------------	-----------------------	---------------------	--------------

M12 connector · Wiring diagram no. 1, 2 · Connector groups 16, 17



663	90	610	0...4 / 3...12	4	24	2	OY104S
-----	----	-----	----------------	---	----	---	--------

813	90	760	0...4 / 3...12	4.5	24	2	OY105S
-----	----	-----	----------------	-----	----	---	--------

963	90	910	0...4 / 3...12	5	24	2	OY106S
-----	----	-----	----------------	---	----	---	--------

1113	90	1060	0...4 / 3...12	5.5	24	2	OY107S
------	----	------	----------------	-----	----	---	--------

1263	90	1210	0...4 / 3...12	5.5	24	2	OY108S
------	----	------	----------------	-----	----	---	--------

1413	90	1360	0...4 / 3...12	6	24	2	OY109S
------	----	------	----------------	---	----	---	--------

1563	90	1510	0...4 / 3...12	6.5	24	2	OY110S
------	----	------	----------------	-----	----	---	--------

Safety light curtains type 4, SIL 3, PL e, resolution 90 mm, protected area width up to 20 m

Type	Sensor length [mm]	Resolution / detection capacity [mm]	Protected area height [mm]	Protected area width [m]	Response time [ms]	U _b [V]	Draw- ing no.	Order no.
------	-----------------------	--	----------------------------------	--------------------------------	--------------------------	-----------------------	---------------------	--------------

M12 connector · Wiring diagram no. 1, 2 · Connector groups 16, 17



663	90	610	0...10 / 3...20	3	24	1	OY204S
-----	----	-----	-----------------	---	----	---	--------

813	90	760	0...10 / 3...20	3.5	24	1	OY205S
-----	----	-----	-----------------	-----	----	---	--------

963	90	910	0...10 / 3...20	3.5	24	1	OY206S
-----	----	-----	-----------------	-----	----	---	--------



Safety technology

Type	Sensor length [mm]	Resolution / detection capacity [mm]	Protected area height [mm]	Protected area width [m]	Response time [ms]	U _b [V]	Draw- ing no.	Order no.
------	-----------------------	--	----------------------------------	--------------------------------	--------------------------	-----------------------	---------------------	--------------

M12 connector - Wiring diagram no. 1, 2 - Connector groups 16, 17

	1113	90	1060	0...10 / 3...20	3.5	24	1	OY2075
	1263	90	1210	0...10 / 3...20	4	24	1	OY2085
	1413	90	1360	0...10 / 3...20	4	24	1	OY2095
	1563	90	1510	0...10 / 3...20	4.5	24	1	OY2105

Safety light curtains type 2, SIL 1, PL c, resolution 30 mm, protected area width up to 12 m

Type	Sensor length [mm]	Resolution / detection capacity [mm]	Protected area height [mm]	Protected area width [m]	Response time [ms]	U _b [V]	Draw- ing no.	Order no.
------	-----------------------	--	----------------------------------	--------------------------------	--------------------------	-----------------------	---------------------	--------------

M12 connector - Wiring diagram no. 1, 2 - Connector groups 16, 17

	213	30	160	0...4 / 3...12	4.5	24	2	OY0315
	363	30	310	0...4 / 3...12	6	24	2	OY0325
	513	30	460	0...4 / 3...12	8	24	2	OY0335
	663	30	610	0...4 / 3...12	9.5	24	2	OY0345
	813	30	760	0...4 / 3...12	11	24	2	OY0355
	963	30	910	0...4 / 3...12	12.5	24	2	OY0365
	1113	30	1060	0...4 / 3...12	14.5	24	2	OY0375
	1263	30	1210	0...4 / 3...12	16	24	2	OY0385
	1413	30	1360	0...4 / 3...12	17.5	24	2	OY0395
	1563	30	1510	0...4 / 3...12	19.5	24	2	OY0405

Type	Sensor length [mm]	Resolution / detection capacity [mm]	Protected area height [mm]	Protected area width [m]	Response time [ms]	U _b [V]	Draw- ing no.	Order no.
------	-----------------------	--	----------------------------------	--------------------------------	--------------------------	-----------------------	---------------------	--------------

M12 connector · Wiring diagram no. 1, 2 · Connector groups 16, 17

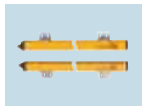

1863	30	1810	0...4 / 3...12	19.5	24	2	OY3005
------	----	------	----------------	------	----	---	--------

Safety light curtains type 2, SIL 1, PL c, resolution 40 mm, protected area width up to 12 m

Type	Sensor length [mm]	Resolution / detection capacity [mm]	Protected area height [mm]	Protected area width [m]	Response time [ms]	U _b [V]	Draw- ing no.	Order no.
------	-----------------------	--	----------------------------------	--------------------------------	--------------------------	-----------------------	---------------------	--------------

M12 connector · Wiring diagram no. 1, 2 · Connector groups 16, 17



213	40	160	0...4 / 3...12	4	24	2	OY051S
-----	----	-----	----------------	---	----	---	--------

363	40	310	0...4 / 3...12	5	24	2	OY052S
-----	----	-----	----------------	---	----	---	--------

513	40	460	0...4 / 3...12	6	24	2	OY053S
-----	----	-----	----------------	---	----	---	--------

663	40	610	0...4 / 3...12	7	24	2	OY054S
-----	----	-----	----------------	---	----	---	--------

813	40	760	0...4 / 3...12	8	24	2	OY055S
-----	----	-----	----------------	---	----	---	--------

963	40	910	0...4 / 3...12	9.5	24	2	OY056S
-----	----	-----	----------------	-----	----	---	--------

1113	40	1060	0...4 / 3...12	10.5	24	2	OY057S
------	----	------	----------------	------	----	---	--------

1263	40	1210	0...4 / 3...12	11.5	24	2	OY058S
------	----	------	----------------	------	----	---	--------

1413	40	1360	0...4 / 3...12	12.5	24	2	OY059S
------	----	------	----------------	------	----	---	--------

1563	40	1510	0...4 / 3...12	13.5	24	2	OY060S
------	----	------	----------------	------	----	---	--------



Safety technology

Safety light curtains type 2, SIL 1, PL c, protected area width up to 12 m

Type	Sensor length [mm]	Resolution / detection capacity [mm]	Protected area height [mm]	Protected area width [m]	Response time [ms]	U _b [V]	Draw- ing no.	Order no.
------	-----------------------	--	----------------------------------	--------------------------------	--------------------------	-----------------------	---------------------	--------------

M12 connector · Wiring diagram no. 1, 2 · Connector groups 16, 17

	363	50	310	0...4 / 3...12	4.5	24	2	OY072S
	513	50	460	0...4 / 3...12	5.5	24	2	OY073S
	663	50	610	0...4 / 3...12	6	24	2	OY074S
	813	50	760	0...4 / 3...12	7	24	2	OY075S
	963	50	910	0...4 / 3...12	8	24	2	OY076S
	1113	50	1060	0...4 / 3...12	9	24	2	OY077S
	1263	50	1210	0...4 / 3...12	10	24	2	OY078S
	1413	50	1360	0...4 / 3...12	10.5	24	2	OY079S
	1563	50	1510	0...4 / 3...12	11.5	24	2	OY080S

Safety light curtains type 2, SIL 1, PL c, resolution 90 mm, protected area width up to 12 m

Type	Sensor length [mm]	Resolution / detection capacity [mm]	Protected area height [mm]	Protected area width [m]	Response time [ms]	U _b [V]	Draw- ing no.	Order no.
------	-----------------------	--	----------------------------------	--------------------------------	--------------------------	-----------------------	---------------------	--------------

M12 connector · Wiring diagram no. 1, 2 · Connector groups 16, 17

	663	90	610	0...4 / 3...12	4	24	2	OY094S
	813	90	760	0...4 / 3...12	4.5	24	2	OY095S
	963	90	910	0...4 / 3...12	5	24	2	OY096S
	1113	90	1060	0...4 / 3...12	5.5	24	2	OY097S

Type	Sensor length [mm]	Resolution / detection capacity [mm]	Protected area height [mm]	Protected area width [m]	Response time [ms]	U _b [V]	Draw- ing no.	Order no.
------	-----------------------	--	----------------------------------	--------------------------------	--------------------------	-----------------------	---------------------	--------------

M12 connector · Wiring diagram no. 1, 2 · Connector groups 16, 17

	1263	90	1210	0...4 / 3...12	6	24	2	OY098S
	1413	90	1360	0...4 / 3...12	6.5	24	2	OY099S
	1563	90	1510	0...4 / 3...12	7	24	2	OY100S

Safety light curtains for hygienic and wet areas, IP 69K, type 4, SIL 3, PL e, resolution 14 mm, protected area width up to 5 m

Type	Sensor length [mm]	Resolution / detection capacity [mm]	Protected area height [mm]	Protected area width [m]	Response time [ms]	U _b [V]	Draw- ing no.	Order no.
------	-----------------------	--	----------------------------------	--------------------------------	--------------------------	-----------------------	---------------------	--------------

Cable 15 m · Wiring diagram no. 4, 5

	637	14	460	0...2 / 1...5	7.5	24	3	OY403S
	937	14	760	0...2 / 1...5	11	24	3	OY405S
	1237	14	1060	0...2 / 1...5	14.5	24	3	OY407S

Safety light curtains for hygienic and wet areas, IP 69K, type 4, SIL 3, PL e, resolution 30 mm, protected area width up to 15 m

Type	Sensor length [mm]	Resolution / detection capacity [mm]	Protected area height [mm]	Protected area width [m]	Response time [ms]	U _b [V]	Draw- ing no.	Order no.
------	-----------------------	--	----------------------------------	--------------------------------	--------------------------	-----------------------	---------------------	--------------

Cable 15 m · Wiring diagram no. 4, 5

	337	30	160	0...7 / 3...15	3	24	3	OY441S
	487	30	310	0...7 / 3...15	4	24	3	OY442S
	637	30	460	0...7 / 3...15	5	24	3	OY443S
	787	30	610	0...7 / 3...15	6	24	3	OY444S
	937	30	760	0...7 / 3...15	6.5	24	3	OY445S



Safety technology

Type	Sensor length [mm]	Resolution / detection capacity [mm]	Protected area height [mm]	Protected area width [m]	Response time [ms]	U _b [V]	Draw- ing no.	Order no.
Cable 15 m · Wiring diagram no. 4, 5								
	1087	30	910	0...7 / 3...15	7.5	24	3	OY446S
	1237	30	1060	0...7 / 3...15	8.5	24	3	OY447S
	1387	30	1210	0...7 / 3...15	9.5	24	3	OY448S
	1537	30	1360	0...7 / 3...15	10	24	3	OY449S
	1687	30	1510	0...7 / 3...15	11	24	3	OY450S
	1987	30	1810	0...7 / 3...15	11	24	3	OY453S

Safety light curtains for hygienic and wet areas, IP 69K, type 2, SIL 1, PL c, resolution 30 mm, protected area width up to 10 m

Type	Sensor length [mm]	Resolution / detection capacity [mm]	Protected area height [mm]	Protected area width [m]	Response time [ms]	U _b [V]	Draw- ing no.	Order no.
Cable 15 m · Wiring diagram no. 4, 5								
	337	30	160	0...3 / 2...10	4.5	24	4	OY431S
	487	30	310	0...3 / 2...10	6	24	4	OY432S
	637	30	460	0...3 / 2...10	8	24	4	OY433S
	787	30	610	0...3 / 2...10	9.5	24	4	OY434S
	937	30	760	0...3 / 2...10	11	24	4	OY435S
	1087	30	910	0...3 / 2...10	12.5	24	4	OY436S
	1237	30	1060	0...3 / 2...10	14.5	24	4	OY437S
	1387	30	1210	0...3 / 2...10	16	24	4	OY438S

Type	Sensor length [mm]	Resolution / detection capacity [mm]	Protected area height [mm]	Protected area width [m]	Response time [ms]	U _b [V]	Draw- ing no.	Order no.
------	-----------------------	--	----------------------------------	--------------------------------	--------------------------	-----------------------	---------------------	--------------

Cable 15 m · Wiring diagram no. 4, 5

	1537	30	1360	0...3 / 2...10	17.5	24	4	OY439S
	1687	30	1510	0...3 / 2...10	19.5	24	4	OY440S

Safety light curtains with floating blanking type 4, SIL 3, PL e, resolution 14 mm, protected area width up to 5 m

Type	Sensor length [mm]	Resolution / detection capacity [mm]	Protected area height [mm]	Protected area width [m]	Response time [ms]	U _b [V]	Draw- ing no.	Order no.
------	-----------------------	--	----------------------------------	--------------------------------	--------------------------	-----------------------	---------------------	--------------

M12 connector · Wiring diagram no. 1, 3 · Connector groups 16, 17

	261	14	160	0...3 / 0...5	6	24	5	OY801S
	711	14	610	0...3 / 0...5	11.5	24	5	OY804S
	861	14	760	0...3 / 0...5	13.5	24	5	OY805S
	1011	14	910	0...3 / 0...5	15.5	24	5	OY806S
	1161	14	1060	0...3 / 0...5	17	24	5	OY807S
	1311	14	1210	0...3 / 0...5	19	24	5	OY808S

Safety light curtains with floating blanking type 4, SIL 3, PL e, resolution 20 mm, protected area width up to 18 m

Type	Sensor length [mm]	Resolution / detection capacity [mm]	Protected area height [mm]	Protected area width [m]	Response time [ms]	U _b [V]	Draw- ing no.	Order no.
------	-----------------------	--	----------------------------------	--------------------------------	--------------------------	-----------------------	---------------------	--------------

M12 connector · Wiring diagram no. 1, 3 · Connector groups 16, 17

	711	20	610	0...6 / 3...18	11.5	24	5	OY815S
	861	20	760	0...6 / 3...18	13.5	24	5	OY816S
	1011	20	910	0...6 / 3...18	15.5	24	5	OY817S



Safety technology

Type	Sensor length [mm]	Resolution / detection capacity [mm]	Protected area height [mm]	Protected area width [m]	Response time [ms]	U _b [V]	Draw- ing no.	Order no.
------	-----------------------	--	----------------------------------	--------------------------------	--------------------------	-----------------------	---------------------	--------------

M12 connector · Wiring diagram no. 1, 3 · Connector groups 16, 17

	1161	20	1060	0...6 / 3...18	17	24	5	OY818S
	1311	20	1210	0...6 / 3...18	19	24	5	OY819S

Safety light curtains with floating blanking type 4, SIL 3, PL e, resolution 40 mm, protected area width up to 18 m





Type	Sensor length [mm]	Resolution / detection capacity [mm]	Protected area height [mm]	Protected area width [m]	Response time [ms]	U _b [V]	Draw- ing no.	Order no.
------	-----------------------	--	----------------------------------	--------------------------------	--------------------------	-----------------------	---------------------	--------------

M12 connector · Wiring diagram no. 1, 3 · Connector groups 16, 17

	711	40	610	0...6 / 3...18	8.5	24	5	OY825S
	861	40	760	0...6 / 3...18	9.5	24	5	OY826S
	1011	40	910	0...6 / 3...18	10.5	24	5	OY827S
	1161	40	1060	0...6 / 3...18	11.5	24	5	OY828S
	1311	40	1210	0...6 / 3...18	12.5	24	5	OY829S



Accessories for safety light curtains

Type	Description	Order no.
	Corner mirror · Length: 250 mm · for safety light curtains · Protected area height · 160 mm · for type OY · Housing materials: aluminium epoxy-powder coated / plastics / Accessories: steel galvanised	EY1001
	Corner mirror · Length: 400 mm · for safety light curtains · Protected area height · 310 mm · for type OY · Housing materials: aluminium epoxy-powder coated / plastics / Accessories: steel galvanised	EY1002
	Corner mirror · Length: 540 mm · for safety light curtains · Protected area height · 460 mm · for type OY · Housing materials: aluminium epoxy-powder coated / plastics / Accessories: steel galvanised	EY1003
	Corner mirror · Length: 715 mm · for safety light curtains · Protected area height · 610 mm · for safety light grids · 2 beams · for type OY · Housing materials: aluminium epoxy-powder coated / plastics / Accessories: steel galvanised	EY1004

Type	Description	Order no.
	Corner mirror · Length: 885 mm · for safety light curtains · Protected area height · 760 mm · for type OY · Housing materials: aluminium epoxy-powder coated / plastics / Accessories: steel galvanised	EY1005
	Corner mirror · Length: 1060 mm · for safety light curtains · Protected area height · 910 mm · for safety light grids · 3 beams · for type OY · Housing materials: aluminium epoxy-powder coated / plastics / Accessories: steel galvanised	EY1006
	Corner mirror · Length: 1230 mm · for safety light curtains · Protected area height · 1060 mm · for safety light grids · 4 beams · for type OY · Housing materials: aluminium epoxy-powder coated / plastics / Accessories: steel galvanised	EY1007
	Corner mirror · Length: 1400 mm · for safety light curtains · Protected area height · 1210 mm · for type OY · Housing materials: aluminium epoxy-powder coated / plastics / Accessories: steel galvanised	EY1008
	Corner mirror · Length: 1450 mm · for safety light curtains · Protected area height · 1360 mm · for type OY · Housing materials: aluminium epoxy-powder coated / plastics / Accessories: steel galvanised	EY1009
	Corner mirror · Length: 1600 mm · for safety light curtains · Protected area height · 1510 mm · for type OY · Housing materials: aluminium epoxy-powder coated / plastics / Accessories: steel galvanised	EY1010
	Vibration damper · for type OY · Housing materials: rubber / metal galvanised	EY3001
	Vibration damper · for type OY · Housing materials: rubber / metal galvanised	EY3002
	Rotatable brackets · axial $\pm 90^\circ$ · for type OY · Housing materials: Angle bracket: steel black	EY3011
	Adjustable brackets · axial $\pm 7^\circ$ · for type OY · Housing materials: metal galvanised	EY3004
	Adjustable brackets · axial $\pm 7^\circ$ · for type OY · Housing materials: metal galvanised	EY3005
	Test rod · \varnothing 14 mm · Probe length: 150 mm · for safety light curtains · for type OY · Housing materials: aluminium	EY3006
	Test rod · \varnothing 20 mm · Probe length: 150 mm · for safety light curtains · for type OY · Housing materials: aluminium	EY3007
	Test rod · \varnothing 30 mm · Probe length: 150 mm · for safety light curtains · for type OY · Housing materials: aluminium	EY3008
	Test rod · \varnothing 40 mm · Probe length: 150 mm · for safety light curtains · for type OY · Housing materials: aluminium	EY3009
	Test rod · \varnothing 50 mm · Probe length: 150 mm · for safety light curtains · for type OY · Housing materials: aluminium	EY3010



Safety technology

Type	Description	Order no.
	Mounting and fine adjustment bracket · for type OY · Housing materials: PA66 reinforced glass-fibre	EY3013
	Laser adjustment aid · for type OY9xxS · for safety light grids · for type OY9 · Housing materials: plastics	EY3098
	Laser adjustment aid · for safety light curtains · for type OY · Housing materials: plastics	EY3099

Bases for safety light curtains

Type	Description	Order no.
	Base · Length: 1010 mm · for safety light grids · 2 beams · for safety light curtains · ≤ 760 mm · for type OY · Housing materials: aluminium epoxy-powder coated / plastics	EY2001
	Base · Length: 1340 mm · for safety light grids · 3 beams · 4 beams · for safety light curtains · ≤ 1060 mm · for type OY · Housing materials: aluminium epoxy-powder coated / plastics	EY2002
	Base · Length: 1710 mm · for safety light curtains · ≤ 1360 mm · for type OY · Housing materials: aluminium epoxy-powder coated / plastics	EY2003
	Base · Length: 1980 mm · for safety light curtains · ≤ 1510 mm · for type OY · Housing materials: aluminium epoxy-powder coated / plastics	EY2004

Bases for safety light curtains with corner mirror

Type	Description	Order no.
	Corner mirror with base · Length: 1010 mm · for safety light grids · 2 beams · for safety light curtains · ≤ 760 mm · for type OY · Housing materials: aluminium epoxy-powder coated / plastics	EY1011
	Corner mirror with base · Length: 1340 mm · for safety light grids · 3 beams · 4 beams · for safety light curtains · ≤ 1060 mm · for type OY · Housing materials: aluminium epoxy-powder coated / plastics	EY1013
	Corner mirror with base · Length: 1710 mm · for safety light curtains · ≤ 1360 mm · for type OY · Housing materials: aluminium epoxy-powder coated / plastics	EY1014
	Corner mirror with base · Length: 1980 mm · for safety light curtains · ≤ 1510 mm · for type OY · Housing materials: aluminium epoxy-powder coated / plastics	EY1015

Accessories necessary for bases

Type	Description	Order no.
	Mounting base · for type OY	EY2005

Wiring diagrams

Core colours

BK	black
BN	brown
BU	blue
GN	green
GY	grey
PK	pink
RD	red
VT	purple
WH	white
YE	yellow

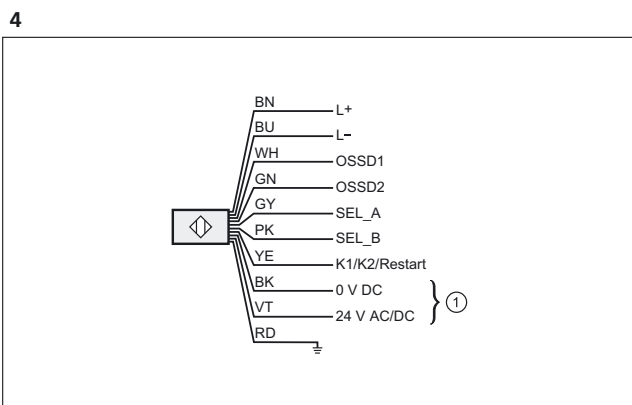
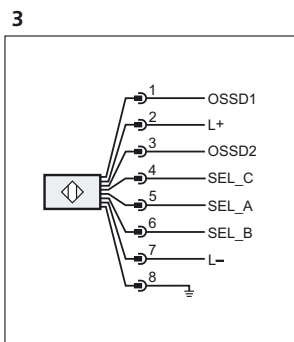
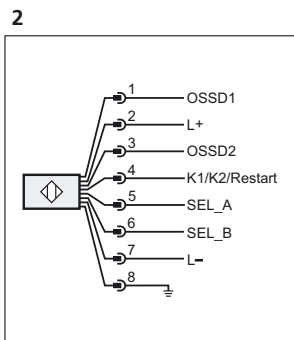
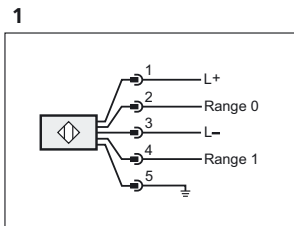

1: Heating

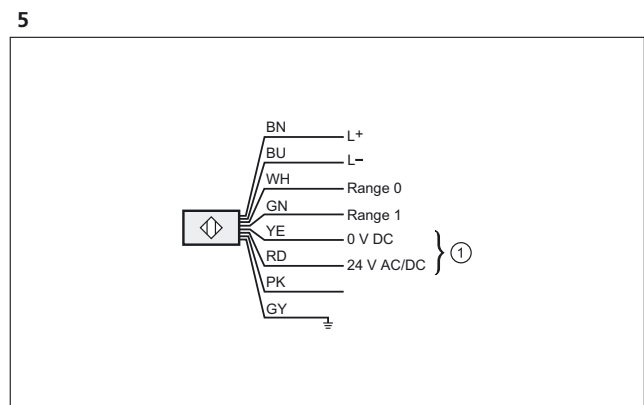

1: Heating, pink: not used



Scale drawings / drawing no. – CAD download: www.ifm.com

1

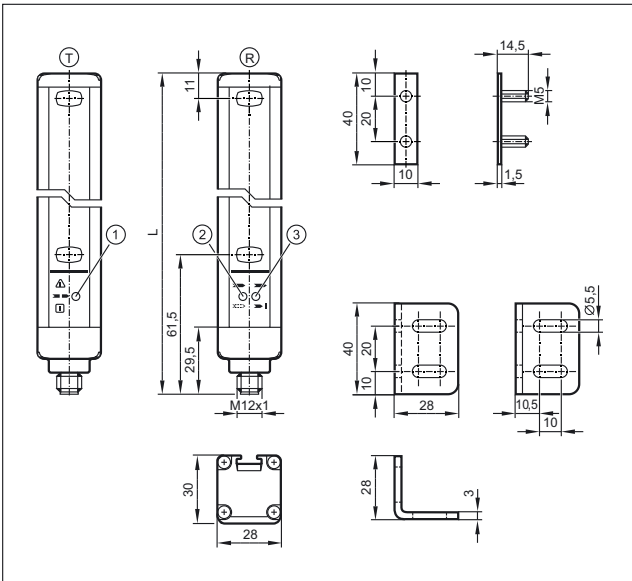

T: Transmitter, R: Receiver, 1: LED 3 colours (red/green/orange),
2: LED 2 colours (yellow/blue), 3: LED 2 colours (red/green)

2

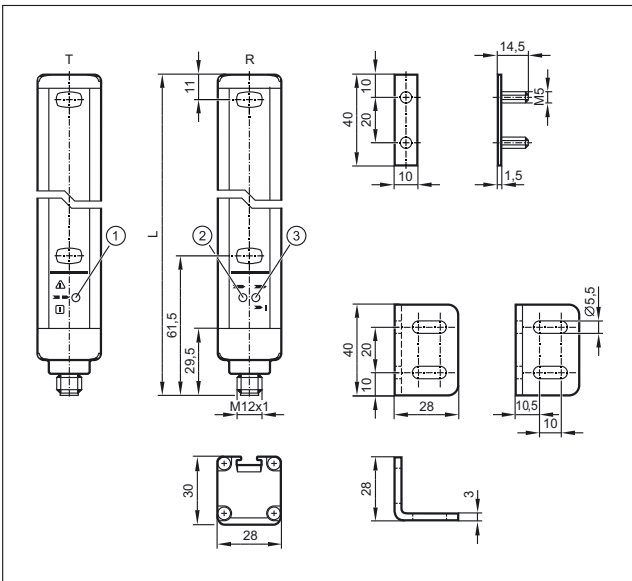

T: Transmitter, R: Receiver, 1: LED 3 colours (red/green/orange),
2: LED (yellow), 3: LED 2 colours (red/green)

3

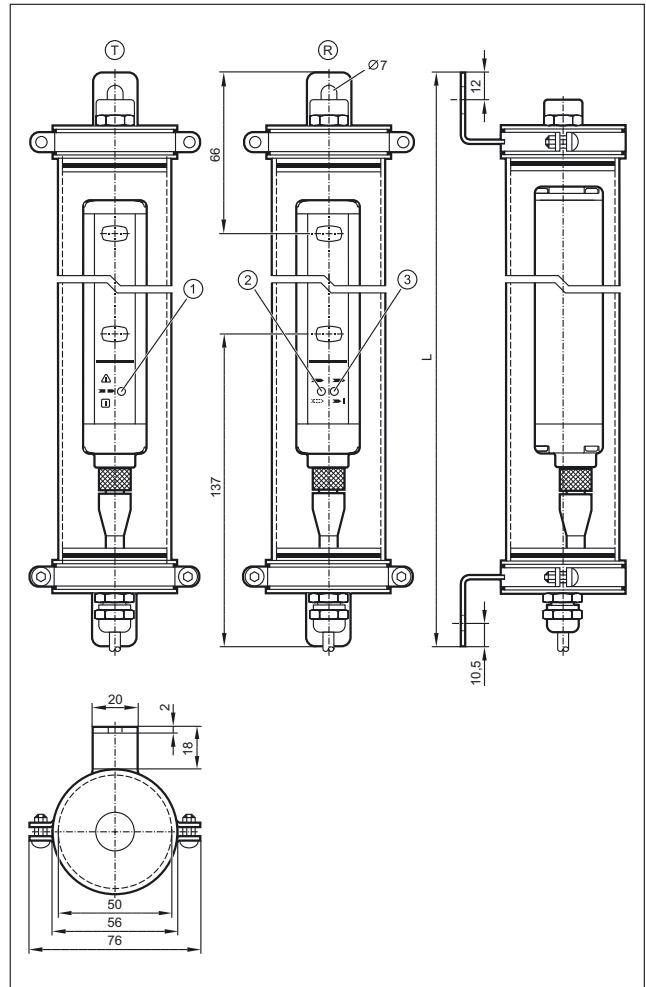

T: Transmitter, R: Receiver, 1: LED 3 colours (red/green/orange),
2: LED 2 colours (yellow/blue), 3: LED 2 colours (red/green)

Scale drawings / drawing no. – CAD download: www.ifm.com

4

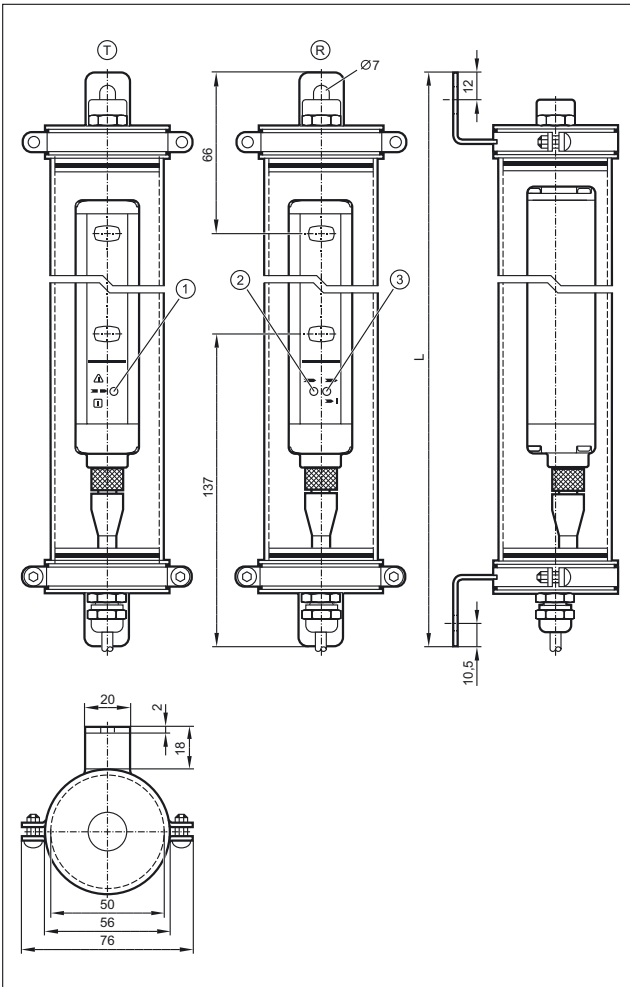

T: Transmitter, R: Receiver, 1: LED 3 colours (red/green/orange),
2: LED 2 colours (yellow/blue), 3: LED 2 colours (red/green)

5

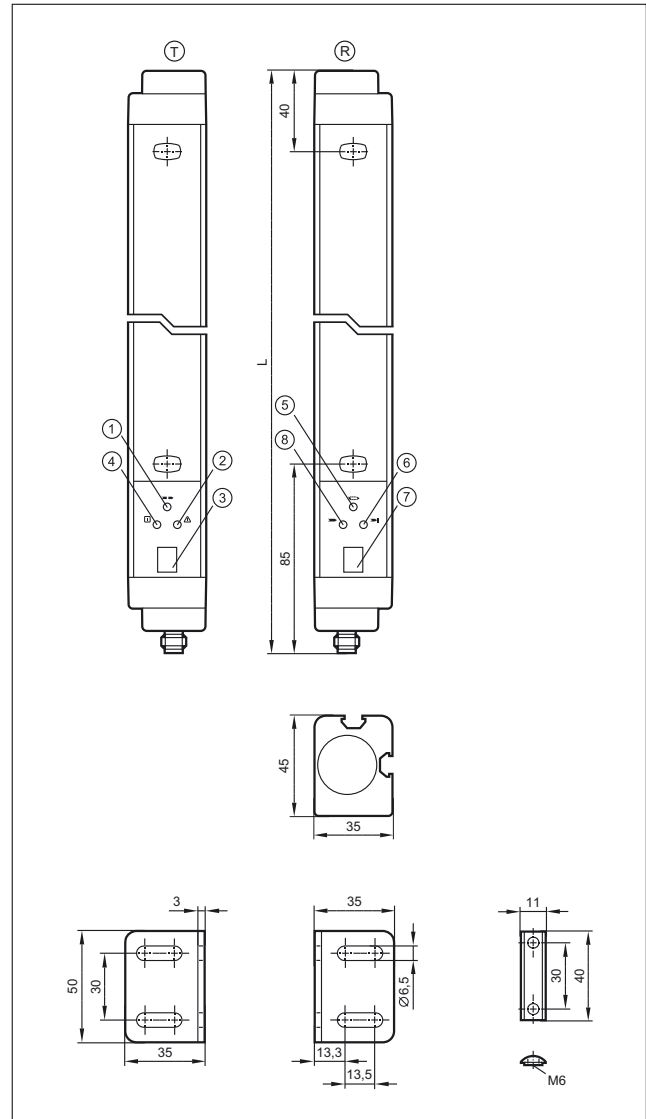

T: Transmitter, R: Receiver, 1: LED yellow, 2: LED red, 3: 7-segment
LED display, 4: LED green, 5: LED yellow, 6: LED red, 7: 7-segment
LCD display, 8: LED green



Safety technology



Safety light grids

Wherever motion of machine parts presents a danger to people or goods, safety light curtains or safety light grids are used.

The protective equipment ensures that the outputs are switched off which results in a machine halt.

System overview	Page
Safety light grids type 2, SIL 1, PL c, 2, 3, 4 beams, protected area width up to 10 m	428
Safety light grids type 4, SIL 3, PL e, 2, 3, 4 beams, protected area width up to 12 m	429
Safety light grids type 4, SIL 3, PL e, 2, 3, 4 beams, protected area width up to 20 m	429
Safety light grids for hygienic and wet areas type 4, SIL 3, PL e, 2, 3, 4 beams, protected area width up to 15 m	429
Safety light grids type 4, SIL 3, PL e, 2, 3, 4 beams, protected area width up to 60 m	430
Safety light grids with active / passive system type 4, SIL 3, PL e, 2, 3, 4 beams, protected area width up to 6 m	430
Safety light grids for hygienic and wet areas type 2, SIL 1, PL c, 2, 3, 4 beams, protected area width up to 10 m	430
Accessories for safety light grids	431
Bases for safety light grids	431
Bases for safety light grids with corner mirror	432
Accessories necessary for bases	432
Wiring diagrams	432
Scale drawings / drawing no. – CAD download: www.ifm.com	433 - 434

Safety light grids type 2, SIL 1, PL c, 2, 3, 4 beams, protected area width up to 10 m

Type	Dimensions [mm]	Number of beams	Protected area height [mm]	Protected area width [m]	Response time [ms]	U _b [V]	Draw- ing no.	Order no.
M12 connector · Wiring diagram no. 1, 2 · Connector groups 16, 17								
	L x 28 x 30	2	510	0...4 / 3...12	3	24	1	OY111S
	L x 28 x 30	3	810	0...4 / 3...12	3.5	24	1	OY112S
	L x 28 x 30	4	910	0...4 / 3...12	3.5	24	1	OY113S

Safety light grids type 4, SIL 3, PL e, 2, 3, 4 beams, protected area width up to 12 m

Type	Dimensions [mm]	Number of beams	Protected area height [mm]	Protected area width [m]	Response time [ms]	U _b [V]	Drawing no.	Order no.
------	--------------------	-----------------	-------------------------------	-----------------------------	-----------------------	-----------------------	-------------	-----------

M12 connector · Wiring diagram no. 1, 2 · Connector groups 16, 17

	L x 28 x 30	2	510	0...4 / 3...12	2.5	24	1	OY114S
	L x 28 x 30	3	810	0...4 / 3...12	3	24	1	OY115S
	L x 28 x 30	4	910	0...4 / 3...12	3	24	1	OY116S

Safety light grids type 4, SIL 3, PL e, 2, 3, 4 beams, protected area width up to 20 m

Type	Dimensions [mm]	Number of beams	Protected area height [mm]	Protected area width [m]	Response time [ms]	U _b [V]	Drawing no.	Order no.
------	--------------------	-----------------	-------------------------------	-----------------------------	-----------------------	-----------------------	-------------	-----------

M12 connector · Wiring diagram no. 1, 2 · Connector groups 16, 17

	L x 28 x 30	2	510	0...10 / 3...20	2.5	24	1	OY120S
	L x 28 x 30	3	810	0...10 / 3...20	2.5	24	1	OY121S
	L x 28 x 30	4	910	0...10 / 3...20	2.5	24	1	OY122S

Safety light grids for hygienic and wet areas type 4, SIL 3, PL e, 2, 3, 4 beams, protected area width up to 15 m

Type	Dimensions [mm]	Number of beams	Protected area height [mm]	Protected area width [m]	Response time [ms]	U _b [V]	Drawing no.	Order no.
------	--------------------	-----------------	-------------------------------	-----------------------------	-----------------------	-----------------------	-------------	-----------

Cable 15 m · Wiring diagram no. 3, 4

	L x 76 x 74	2	510	0...7 / 3...15	2.5	24	2	OY421S
	L x 76 x 74	3	810	0...7 / 3...15	2.5	24	2	OY422S
	L x 76 x 74	4	910	0...7 / 3...15	2.5	24	2	OY423S



Safety technology

Safety light grids type 4, SIL 3, PL e, 2, 3, 4 beams, protected area width up to 60 m

Type	Dimensions [mm]	Number of beams	Protected area height [mm]	Protected area width [m]	Response time [ms]	U _b [V]	Draw- ing no.	Order no.
------	--------------------	--------------------	----------------------------------	--------------------------------	--------------------------	-----------------------	---------------------	--------------

M12 connector · Wiring diagram no. 1, 2 · Connector groups 16, 17

	L x 50 x 60	2	510	8...30 / 18...60	7	24	3	OY951S
	L x 50 x 60	3	810	8...30 / 18...60	7	24	3	OY952S
	L x 50 x 60	4	910	8...30 / 18...60	7	24	3	OY953S

Safety light grids with active / passive system type 4, SIL 3, PL e, 2, 3, 4 beams, protected area width up to 6 m

Type	Dimensions [mm]	Number of beams	Protected area height [mm]	Protected area width [m]	Response time [ms]	U _b [V]	Draw- ing no.	Order no.
------	--------------------	--------------------	----------------------------------	--------------------------------	--------------------------	-----------------------	---------------------	--------------

M12 connector · Wiring diagram no. 2 · Connector groups 16, 17

	L x 50 x 60	2	510	0...6 / 0...6	10	24	4	OY901S
	L x 50 x 60	3	810	0...6 / 0...6	10.5	24	4	OY902S
	L x 50 x 60	4	910	0...6 / 0...6	10.5	24	4	OY903S







Safety light grids for hygienic and wet areas type 2, SIL 1, PL c, 2, 3, 4 beams, protected area width up to 10 m

Type	Dimensions [mm]	Number of beams	Protected area height [mm]	Protected area width [m]	Response time [ms]	U _b [V]	Draw- ing no.	Order no.
------	--------------------	--------------------	----------------------------------	--------------------------------	--------------------------	-----------------------	---------------------	--------------

Cable 15 m · Wiring diagram no. 3, 4

	L x 76 x 74	2	510	0...3 / 2...10	3	24	5	OY411S
	L x 76 x 74	3	810	0...3 / 2...10	3.5	24	5	OY412S
	L x 76 x 74	4	910	0...3 / 2...10	3.5	24	5	OY413S

Accessories for safety light grids

Type	Description	Order no.
	Corner mirror · Length: 715 mm · for safety light curtains · Protected area height · 610 mm · for safety light grids · 2 beams · f or type OY · Housing materials: aluminium epoxy-powder coated / plastics / Accessories: steel galvanised	EY1004
	Corner mirror · Length: 1060 mm · for safety light curtains · Protected area height · 910 mm · for safety light grids · 3 beams · for type OY · Housing materials: aluminium epoxy-powder coated / plastics / Accessories: steel galvanised	EY1006
	Corner mirror · Length: 1230 mm · for safety light curtains · Protected area height · 1060 mm · for safety light grids · 4 beams · for type OY · Housing materials: aluminium epoxy-powder coated / plastics / Accessories: steel galvanised	EY1007
	Vibration damper · for type OY · Housing materials: rubber / metal galvanised	EY3001
	Vibration damper · for type OY · Housing materials: rubber / metal galvanised	EY3002
	Rotatable brackets · axial $\pm 90^\circ$ · for type OY · Housing materials: Angle bracket: steel black	EY3011
	Adjustable brackets · axial $\pm 7^\circ$ · for type OY · Housing materials: metal galvanised	EY3004
	Adjustable brackets · axial $\pm 7^\circ$ · for type OY · Housing materials: metal galvanised	EY3005
	Laser adjustment aid · for type OY9xxS · for safety light grids · for type OY9 · Housing materials: plastics	EY3098
	Laser adjustment aid · for safety light curtains · for type OY · Housing materials: plastics	EY3099

Bases for safety light grids

Type	Description	Order no.
	Base · Length: 1010 mm · for safety light grids · 2 beams · for safety light curtains · ≤ 760 mm · for type OY · Housing materials: aluminium epoxy-powder coated / plastics	EY2001
	Base · Length: 1340 mm · for safety light grids · 3 beams · 4 beams · for safety light curtains · ≤ 1060 mm · for type OY · Housing materials: aluminium epoxy-powder coated / plastics	EY2002



Safety technology

Bases for safety light grids with corner mirror

Type	Description	Order no.
	Corner mirror with base · Length: 1010 mm · for safety light grids · 2 beams · for safety light curtains · ≤ 760 mm · for type OY · Housing materials: aluminium epoxy-powder coated / plastics	EY1011
	Corner mirror with base · Length: 1340 mm · for safety light grids · 3 beams · 4 beams · for safety light curtains · ≤ 1060 mm · for type OY · Housing materials: aluminium epoxy-powder coated / plastics	EY1013

Accessories necessary for bases

Type	Description	Order no.
	Mounting base · for type OY	EY2005

Wiring diagrams

Core colours

BK	black
BN	brown
BU	blue
GN	green
GY	grey
PK	pink
RD	red
VT	purple
WH	white
YE	yellow

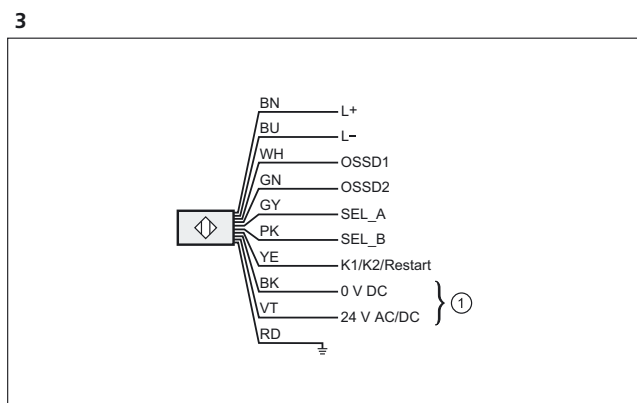
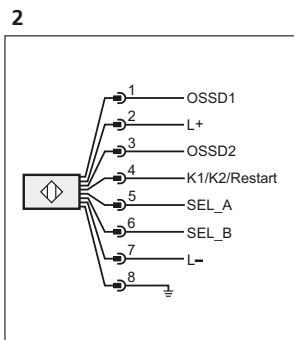
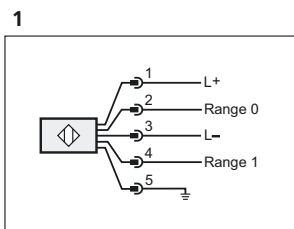

1: Heating

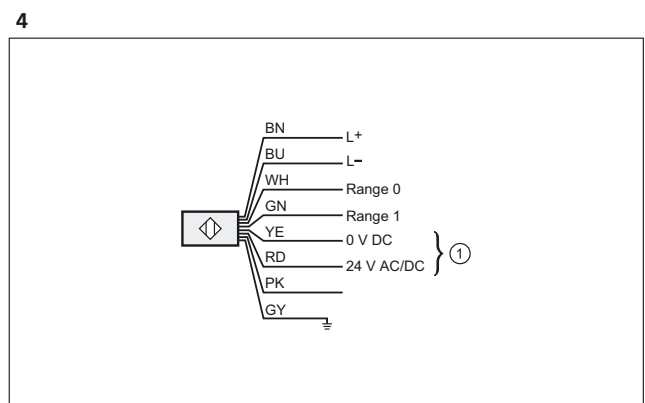

1: Heating, pink: not used

Scale drawings / drawing no. – CAD download: www.ifm.com

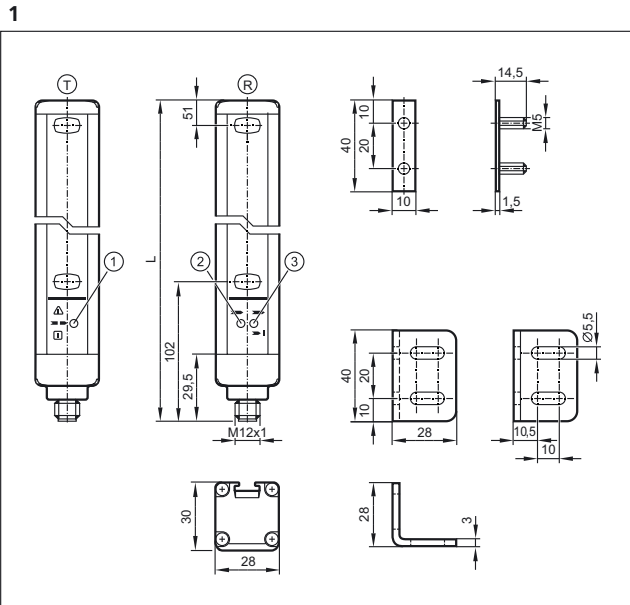

T: Transmitter, R: Receiver, 1: LED 3 colours (red/green/orange), 2: LED yellow, 3: LED 2 colours (red/green)

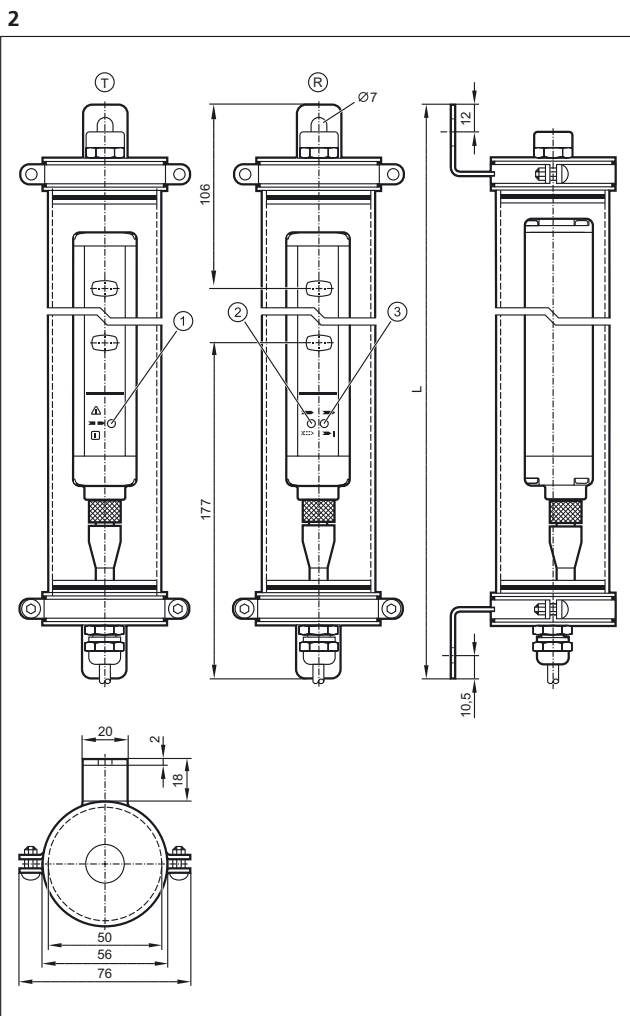

T: Transmitter, R: Receiver, 1: LED 3 colours (red/green/orange), 2: LED 2 colours (yellow/blue), 3: LED 2 colours (red/green)

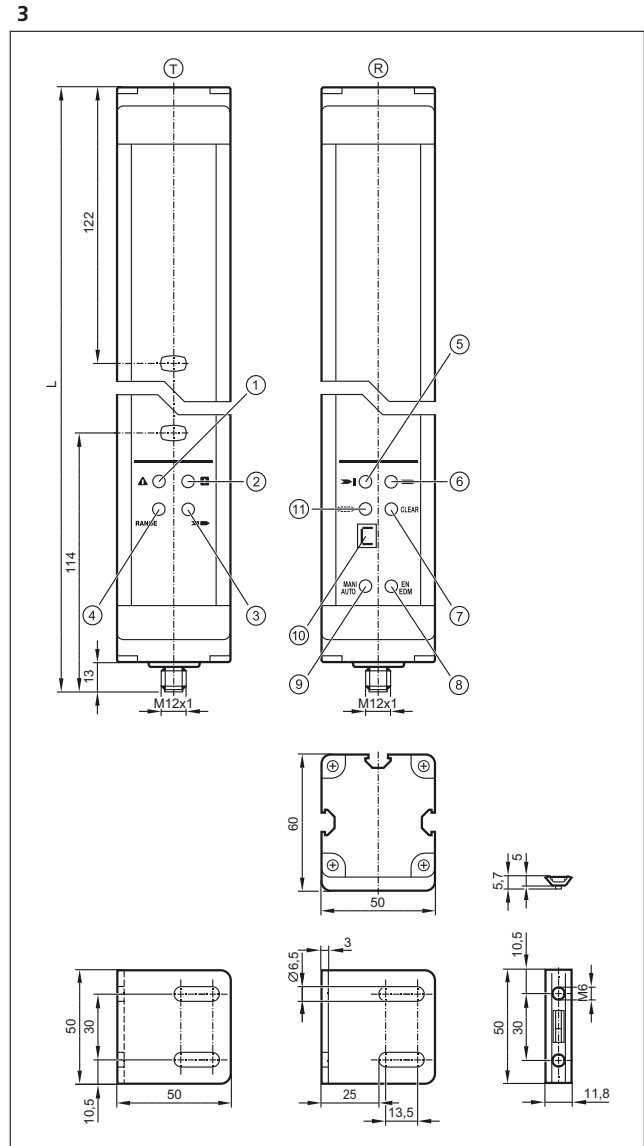

T: Transmitter, R: Receiver, 1: LED (red), 2: LED (green), 3: LED (yellow), 4: LED (orange), 5: LED (red), 6: LED (green), 7: LED (yellow), 8: LED (yellow), 9: LED (yellow), 10: display, 11: LED (orange)



Scale drawings / drawing no. – CAD download: www.ifm.com

4

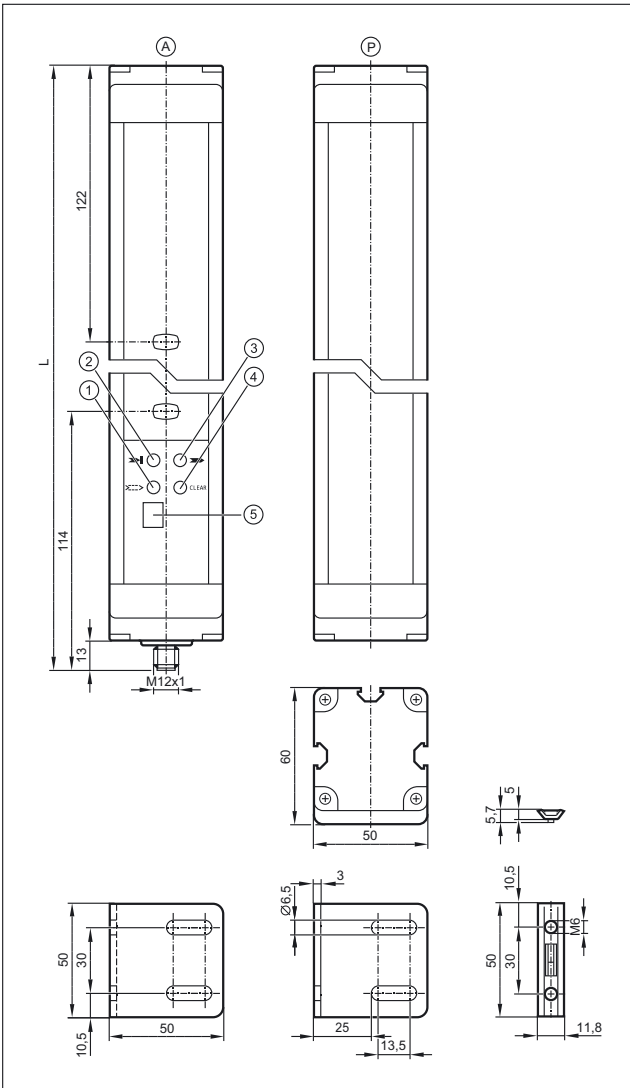

A: active element, P: passive element, 1: LED (orange), 2: LED (red), 3: LED (green), 4: LED (yellow), 5: display

5

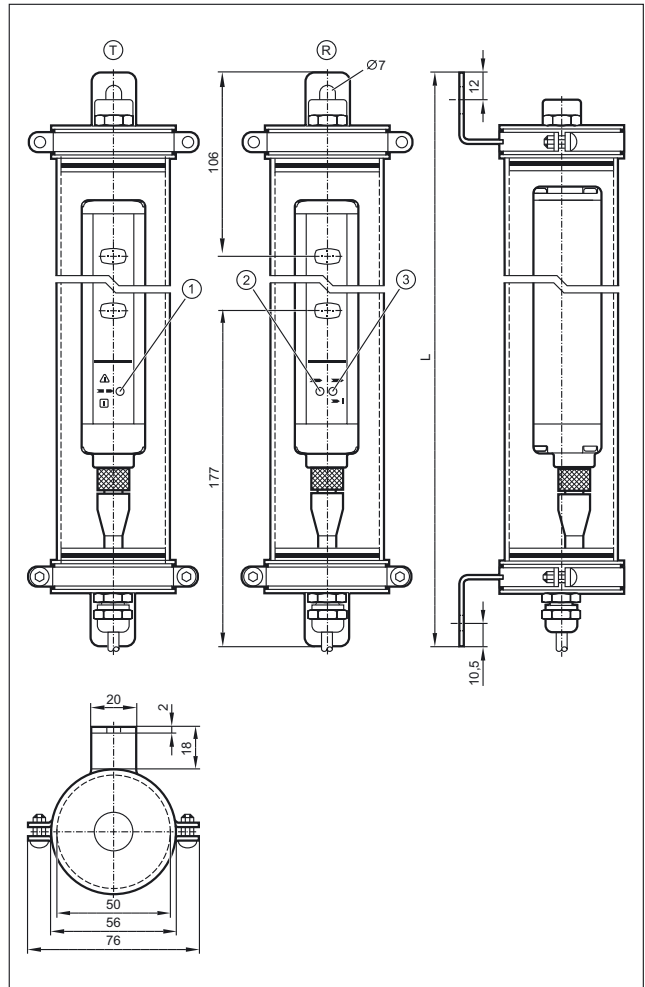

T: Transmitter, R: Receiver, 1: LED 3 colours (red/green/orange), 2: LED 2 colours (yellow/blue), 3: LED 2 colours (red/green)





Safety technology





Safety relays

Multifunctional with the advantage on your side: The safety relays provide various connection options for safety light curtains, fail-safe inductive sensors or other non-contact guards. They meet the highest requirement with SIL 3 (IEC 61508). "Monitored" or "automatic start" as well as external muting are only some of numerous functions.

System overview	Page
Safety relays with relay outputs for fail-safe sensors	436
Safety relays with solid state outputs for fail-safe sensors	436
Safety relays for safety light curtains	436
Accessories	437
Scale drawings / drawing no. – CAD download: www.ifm.com	437

Safety relays with relay outputs for fail-safe sensors

Type	U _b [V]	Electrical design	ISO 13849-1: Category / performance level	IEC 61508: SIL	Draw- ing no.	Order no.
	24	Relay	4 / e	3	1	G15015
	24	Relay	4 / e	3	2	G15025

Safety relays with solid state outputs for fail-safe sensors

Type	U _b [V]	Electrical design	ISO 13849-1: Category / performance level	IEC 61508: SIL	Draw- ing no.	Order no.
	24	Semi-conductor outputs	4 / e	3	3	G15035

Safety relays for safety light curtains

Type	U _b [V]	Electrical design	ISO 13849-1: Category / performance level	IEC 61508: SIL	Draw- ing no.	Order no.
	24	Relay	4 / e	3	4	G20015

Accessories

Type	Description	Order no.
	Combicon connector · with cage clamps 4 poles · Housing materials: PA / current carrying parts: copper alloy tin-plated	E11930

Scale drawings / drawing no. – CAD download: www.ifm.com

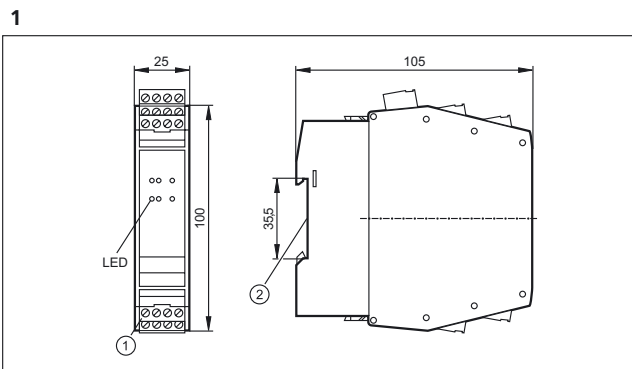

1: Combicon connector with screw terminals, 2: Mounting on DIN rail

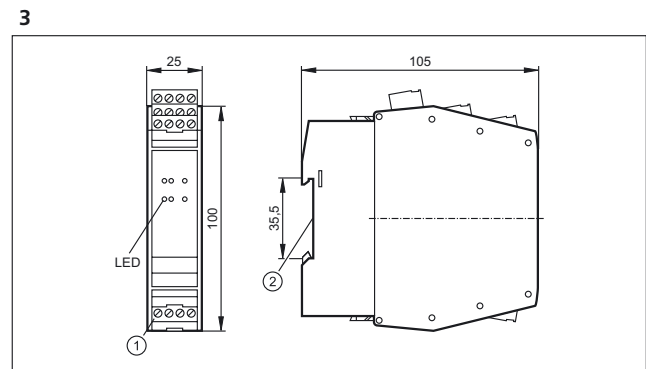

1: Combicon connector with screw terminals, 2: Mounting on DIN rail

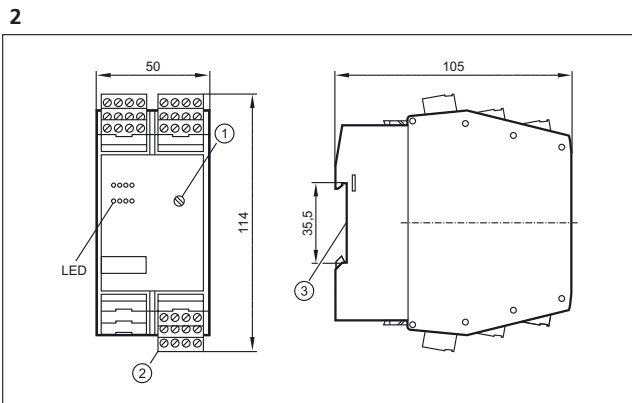

1: Rotary switch for switch-off delay, 2: Combicon connector with screw terminals, 3: Mounting on DIN rail

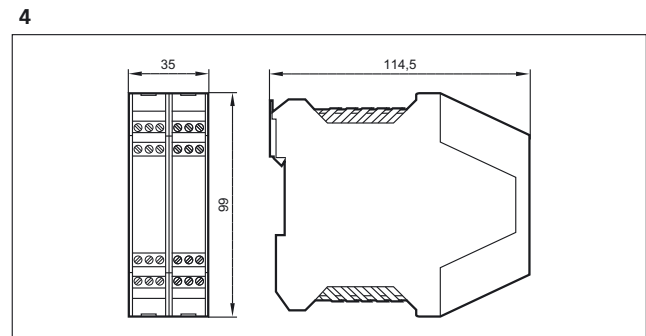



Safety technology





Safety controllers





Controllers for safety-related applications up to safety category 3 (EN 954-1) are called "safety controllers". Special test routines for hardware and software monitoring are implemented in the devices. Due to the certification of the hardware, operating system software and programming tools it is easy for the project engineer to get the approval for the machine.



System overview	Page
SafetyController 32 bits	438
Accessories and software	438 - 439
Scale drawings / drawing no. – CAD download: www.ifm.com	439

SafetyController 32 bits

Type	Inputs / outputs total	Inputs	Outputs	Interfaces	Drawing no.	Order no.
SILCl 2 (IEC 62061), PL d (EN ISO 13849-1), Configurable input / output functions, Programming according to IEC 61131-3						
	32	16 x Digital 16 x analogue (U/I) 16 x frequency	16 x Digital 16 x PWM-I 16 x PWM 2 x H bridge	4 x CAN 1 x RS-232 1 x USB	1	CR7032
	80	32 x Digital 32 x analogue (U/I) 32 x frequency	48 x Digital 32 x PWM-I 32 x PWM 4 x H bridge	4 x CAN 1 x RS-232 1 x USB	2	CR7132

Accessories and software

Type	Description	Order no.
	Programming software CODESYS · for configuration, programming and diagnosis of ifm controller systems · German version · incl. the DVD "Software, tools and documentation"	CP9006
	Programming software CODESYS · for configuration, programming and diagnosis of ifm controller systems · English version · incl. the DVD "Software, tools and documentation"	CP9008
	Connector AMP 55-pole · wirable · with contacts (Junior Power Timer)	EC2013
	Cable with connector · AMP 55-pole · wired · Cable length 1.2 m · Cores sealed individually · Core cross-section 1 mm ²	EC2084

Type	Description	Order no.
	Cable with connector · AMP 55-pole · wired · Cable length 2.5 m · Cores sealed individually · Core cross-section 1 mm ²	EC2097
	Cable with connector · AMP 55-pole · wired · Cable length 1.2 m · Core cross-section 1 mm ²	EC2086
	Cable with connector · AMP 55-pole · wired · Cable length 2.5 m · Core cross-section 1 mm ²	EC2046

Scale drawings / drawing no. – CAD download: www.ifm.com

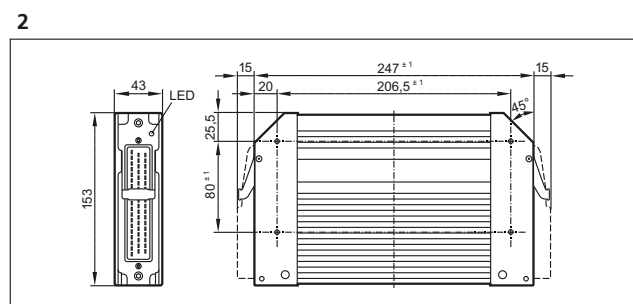
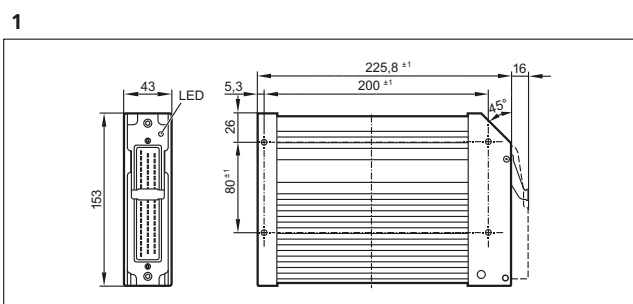



Safety technology











AS-Interface Safety at Work

The sophisticated AS-i technology and the extended diagnostic possibilities provide high reliability and machine uptime. "Safety at Work" is the extension of the AS-interface by safety-related components. Safety components up to the highest control category 4 to EN 954-1, SIL 3 to IEC 61508 and EN ISO 13849 - 1 / PL e can be connected to AS-i.

System overview	Page
Safety at Work	440 - 441
Accessories Safety at Work	442
AS-i manuals	442
Scale drawings / drawing no. – CAD download: www.ifm.com	443 - 445

Safety at Work

Type	Description	Draw- ing no.	Order no.
	AS-i safety monitor · Basic version · 1-channel · Configuration and setup by configuration software ASIMON · Screw terminal · polyamide black · Complies with the requirements: ISO 13849-1: PL e · IEC 61508: SIL 3	1	AC001S
	AS-i safety monitor · Basic version · 2-channel · Configuration and setup by configuration software ASIMON · Screw terminal · polyamide black · Complies with the requirements: ISO 13849-1: PL e · IEC 61508: SIL 3	1	AC002S
	AS-i safety monitor · Extended functionality · 1-channel · Configuration and setup by configuration software ASIMON · Screw terminal · polyamide black · Complies with the requirements: ISO 13849-1: PL e · IEC 61508: SIL 3	1	AC003S
	AS-i safety monitor · Extended functionality · 2-channel · Configuration and setup by configuration software ASIMON · Screw terminal · polyamide black · Complies with the requirements: ISO 13849-1: PL e · IEC 61508: SIL 3	1	AC004S
	AS-i safety monitor · Extended functionality and integrated safe slave for triggering a safe AS-i output · 2-channel · Configuration and setup by configuration software ASIMON V3.0 · Screw terminal · polyamide black · Complies with the requirements: ISO 13849-1: category 4 · ISO 13849-1: PL e · IEC 61508: SIL 3	2	AC032S
	AS-i safety monitor · 2 safe semi-conductor outputs · SIL 3 to EN 62061, IEC 61508 / SIL 3 and EN ISO 13849 - 1 / PL e · Chip card to save the configuration data · Configuration and setup by configuration software ASIMON V3 G2 · USB 2.0 interface · Chip card and Combicon screw terminals supplied with the device · Screw terminal	3	AC041S
	Safe active AS-i module · Performance Level e to EN ISO 13849-1 et IEC 61508 / SIL 3 for the connection of mechanical contacts · Combicon connection · PA · Complies with the requirements: ISO 13849-1: category 4 · ISO 13849-1: PL e · IEC 61508: SIL 3	4	AC009S
	Safe active AS-i output module · SIL 3 to EN 62061, IEC 61508 / SIL 3 and EN ISO 13849 - 1 / PL e · for the safe triggering of actuators · Combicon connection · PA · Complies with the requirements: ISO 13849-1: PL e · IEC 61508: SIL 3	5	AC030S
	AS-i Safety at Work · Safe AS-i input module 2SI - 2LO · Addressing socket · Three orientations of the flat cable are possible · Sockets M12 x 1 · PA / Piercing contacts: CuSn6 surface nickel and tin-plated · Complies with the requirements: ISO 13849-1: category 4 · ISO 13849-1: PL e · IEC 62061: SILcl 3	6	AC505S

Type	Description	Draw- ing no.	Order no.
	AS-i Safety at Work · Safe AS-i input module 4SI / 2DO T / 2LO · Addressing socket · Three orientations of the flat cable are possible · Sockets M12 x 1 · PA / Piercing contacts: CuSn6 surface nickel and tin-plated · Complies with the requirements: ISO 13849-1: category 3 · ISO 13849-1: PL d · IEC 62061: SILcl 2	6	AC506S
	AS-i Safety at Work · Addressing socket · Three orientations of the flat cable are possible · Sockets M12 x 1 · PA / Piercing contacts: CuSn6 surface nickel and tin-plated · Complies with the requirements: ISO 13849-1: category 4 · ISO 13849-1: PL e · IEC 61508: SIL 3 · IEC 62061: SILcl 3	6	AC507S
	AS-i Safety at Work · Sockets M12 x 1 · PA / Piercing contacts: CuSn6 surface nickel and tin-plated · Complies with the requirements: ISO 13849-1: category 3 · ISO 13849-1: PL d · IEC 62061: SILcl 2	6	AC509S
	Illuminated E-STOP · front mounting · reset by turning · 2 NC contacts / 1 red LED · fool-proof E-STOP to EN ISO 13850	7	E7007S
	Illuminated E-STOP with integrated AS-i connection · fool-proof E-STOP to EN ISO 13850 · Pull to reset · AS-i interface via AS-i flat cable IP 67 · PC GF20 · Complies with the requirements: ISO 13849-1: category 4 · ISO 13849-1: PL e · IEC 61508: SIL 3	8	AC010S
	Key-release E-STOP with integrated AS-i connection · Connector M12 x 1 · AS-i interface via AS-i flat cable IP 67 · fool-proof E-STOP to EN ISO 13850 · Reset by key operation · PC GF20 · Complies with the requirements: ISO 13849-1: category 4 · ISO 13849-1: PL e · IEC 61508: SIL 3	9	AC011S
	safe AS-i e-stop operating unit with integrated AS-i connection · AS-i interface via M12 x 1 connector · fool-proof E-STOP to EN ISO 13850 · Pull to reset · interchangeable button inserts · Complies with the requirements: ISO 13849-1: category 4 · ISO 13849-1: PL e · IEC 61508: SIL 3	10	AC012S
	AS-i safety PCB · Connection of mechanical contact and LED components · Certification to ISO 13849-1: PL e and IEC 61508 / SIL 3 · Complies with the requirements: · IEC 61508: SIL 3	11	AC015S
	Fail-safe inductive sensor · M12 connector, Gold-plated contacts · PPE / diecast zinc · Complies with the requirements: ISO 13849-1: category 4 · ISO 13849-1: PL e · IEC 61508: SIL 3	12	GM504S
	Fail-safe inductive sensor · M12 connector, Gold-plated contacts · PPE / diecast zinc · Complies with the requirements: ISO 13849-1: category 4 · ISO 13849-1: PL e · IEC 61508: SIL 3	12	GM505S
	Fail-safe inductive sensor · M18 x 1 · M12 connector, Gold-plated contacts · high-grade stainless steel / PBT · Complies with the requirements: ISO 13849-1: category 4 · ISO 13849-1: PL e · IEC 61508: SIL 3	13	GG505S
	Fail-safe inductive sensor · M30 x 1.5 · M12 connector, Gold-plated contacts · PEEK / high-grade stainless steel / O-ring: EPDM · Complies with the requirements: ISO 13849-1: category 4 · ISO 13849-1: PL e · IEC 61508: SIL 3	14	GI505S
	Safety switch with guard locking · Normally closed principle · Rotatable actuating head made of metal · Mechanical release on the front · Supply via AS-i / solenoid supply ext. from 24 V DC · M12 connector · thermoplastic reinforced glass-fibre	15	AC901S
	Safety switch with guard locking · Normally open principle · Rotatable actuating head made of metal · Mechanical release on the front · Supply via AS-i / solenoid supply ext. from 24 V DC · M12 connector · thermoplastic reinforced glass-fibre	15	AC902S
	Safety switch with guard locking · Normally closed principle · Rotatable actuating head made of metal · Mechanical release on the front · Supply via AS-i / solenoid supply from AS-i · M12 connector · thermoplastic reinforced glass-fibre	16	AC903S
	Safety switch with guard locking · Normally open principle · Rotatable actuating head made of metal · Mechanical release on the front · Supply via AS-i / solenoid supply from AS-i · M12 connector · thermoplastic reinforced glass-fibre	16	AC904S





Safety technology

Accessories Safety at Work

Type	Description	Order no.
	AS-i Safety at Work · Programming software for AS-i safety monitor AC001S / AC002S / AC003S / AC004S / AC032S · Version 3.0 · Configuration, set-up and diagnostics of the AS-i safety monitor	E7040S
	Software ASIMON V3 G2 · Configuration, set-up and diagnostics of the AS-i safety monitor · AC041S	E7050S
	USB interface cable for the connection of the safety monitor AC041S to the PC · cable length 1.8 m · 1.8 m	E7051S
	Chip card to save the configuration data of the AS-i safety monitor AC041S · 256 K	E7052S
	Safe contact expander without delay · 2 independent channels · 4 contact blocks (NO) per channel · 1 feedback circuit (NC) per channel · Mounting on DIN rail · Screw terminal	E7053S
	Connection cable PC / AS-i safety monitor · Parameter setting cable PC / AS-i safety monitor · Western connector RJ 45 8 poles / D-Sub socket 9 poles · 2.5 m	E7001S
	Connection cable AS-i safety monitor / AS-i safety monitor · Download cable AS-i safety monitor / AS-i safety monitor · Western connector RJ 45 8 poles · 0.3 m	E7002S
	EMERGENCY STOP label IP66 4 languages DE, UK, FR, IT · EMERGENCY STOP label 4 languages for a safe illuminated EMERGENCY STOP button with integrated AS-i interface AC010S / AC011S / AC012S · 50 x 50 mm	E7003S
	EMERGENCY STOP protective collar · EMERGENCY STOP protective collar for safe E-STOP AC010S / AC011S / AC012S · Housing materials: PC GF20 RAL 1004	E7004S
	bridging plug for safety modules · Housing materials: PUR	E7005S
	Bulkhead connector · straight · M20 - M12 · M12 connector · 0.07 m · Housing materials: polyamide	E7006S

AS-i manuals

Type	Description	Order no.
	ecolog asi system · AS-Interface Manual (German)	AC011S
	ecolog asi system · AS-Interface Manual (English)	AC0116

Scale drawings / drawing no. – CAD download: www.ifm.com

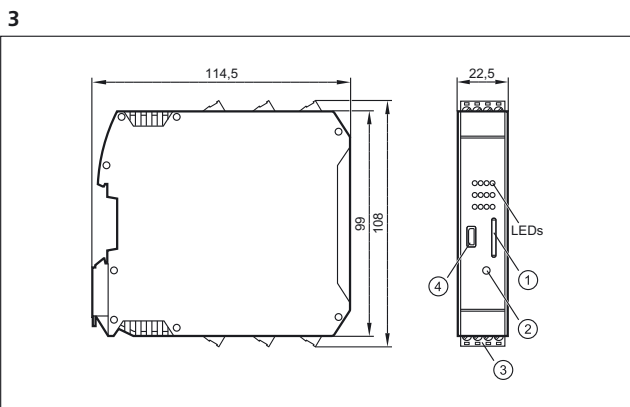
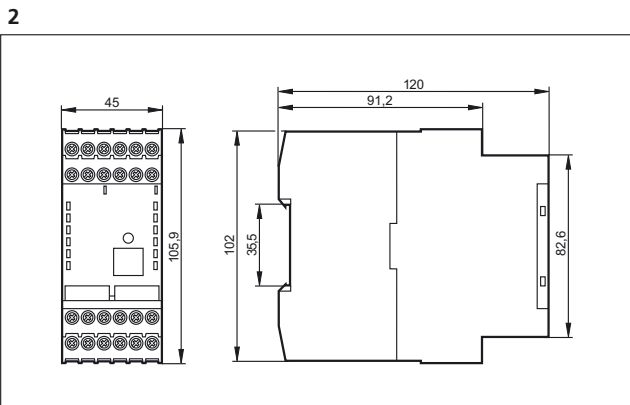
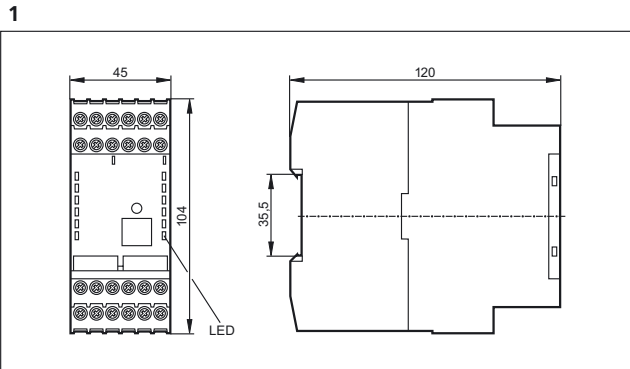

1: Chip card, 2: service button, 3: CombiCon connector with screw terminals, 4: Micro USB interface

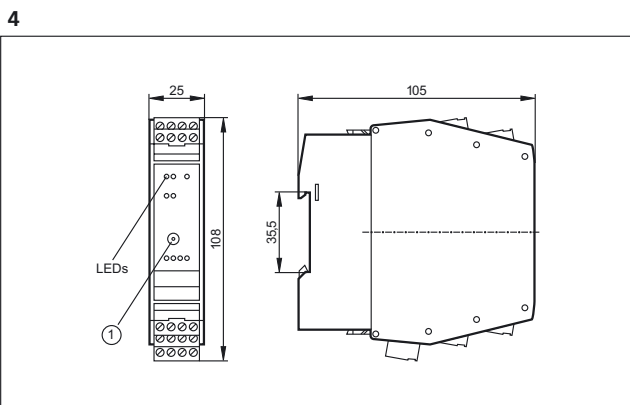

1: Addressing socket

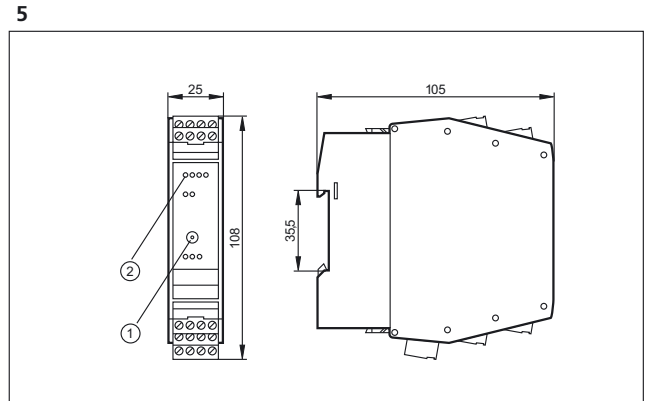

1: Addressing socket, 2: LED

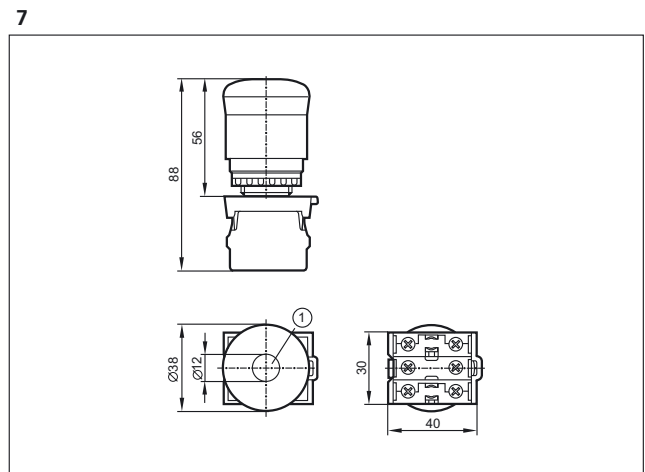
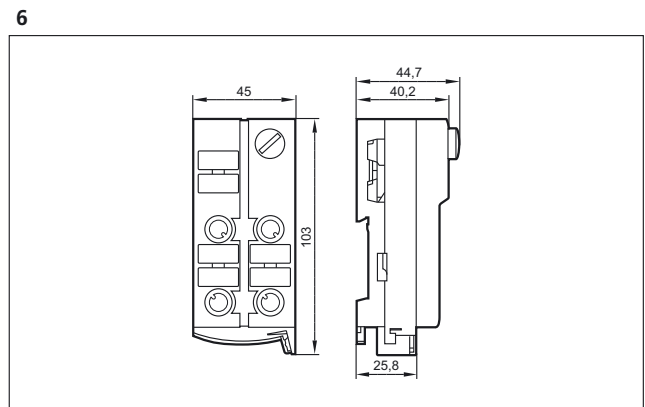



Scale drawings / drawing no. – CAD download: www.ifm.com

8

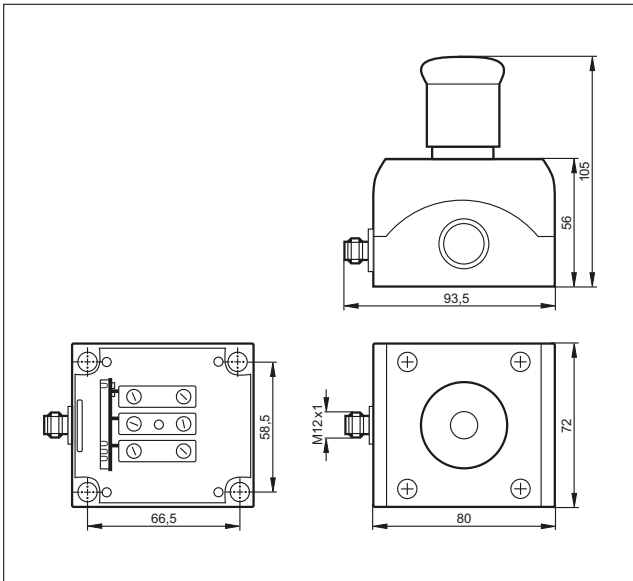

9

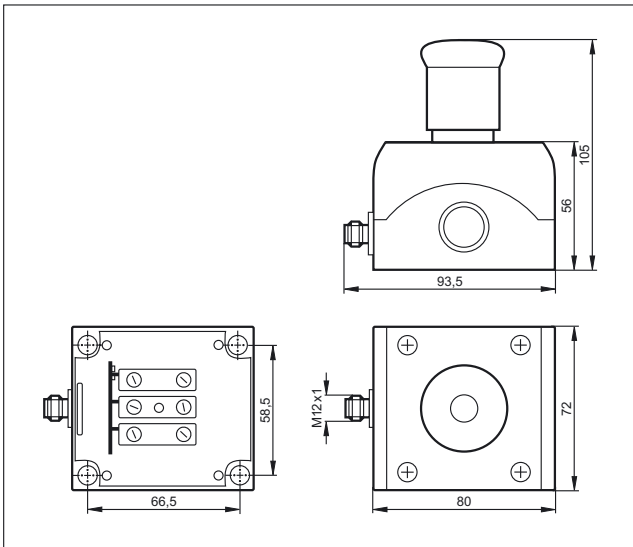

10

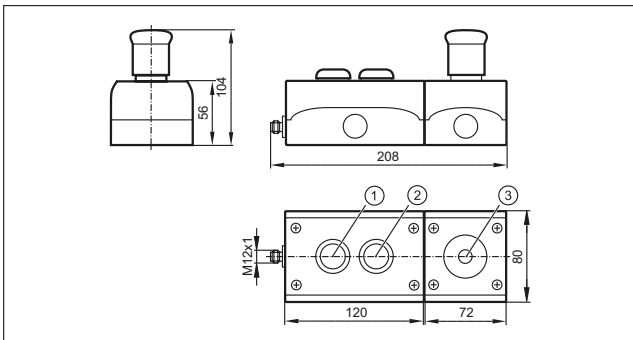

11

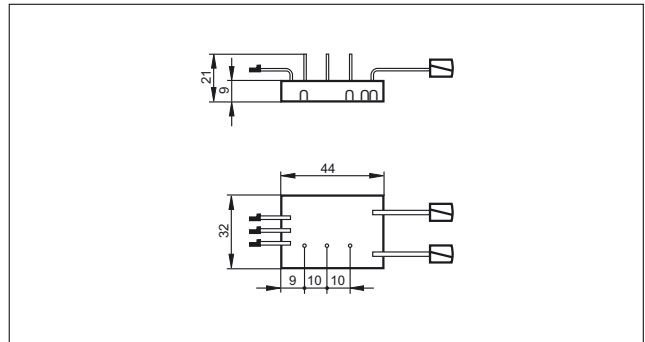

12

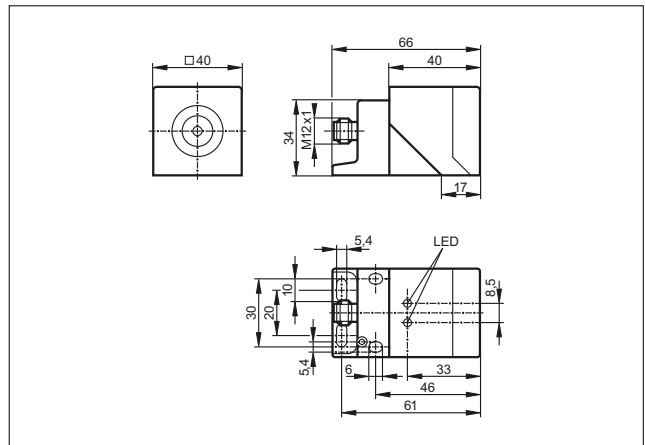

13

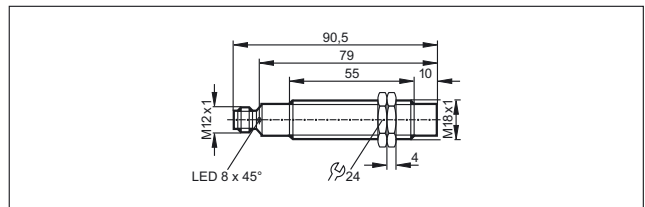

14

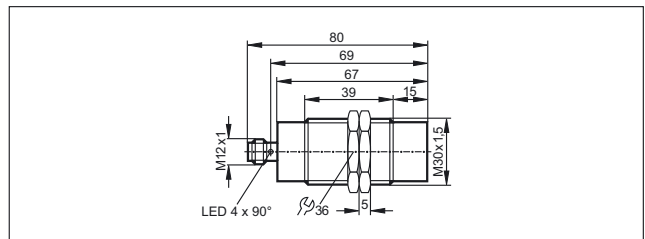

Scale drawings / drawing no. – CAD download: www.ifm.com

15

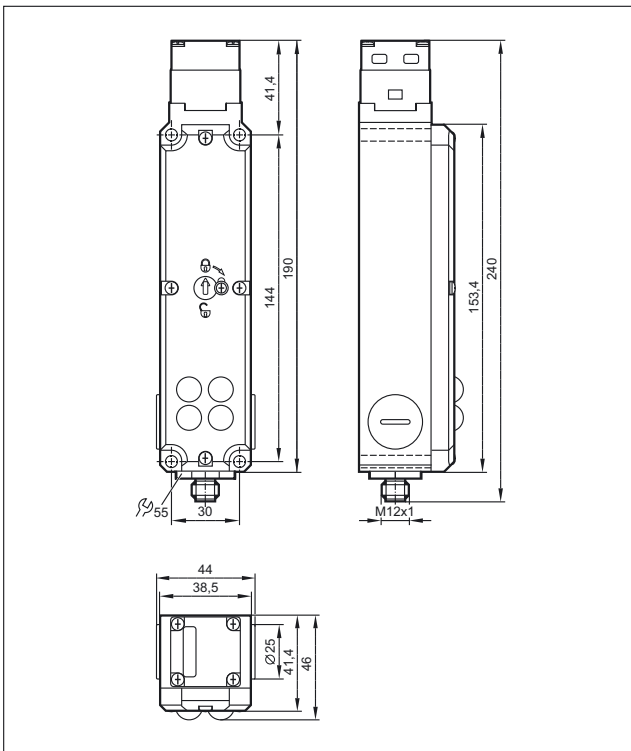

16

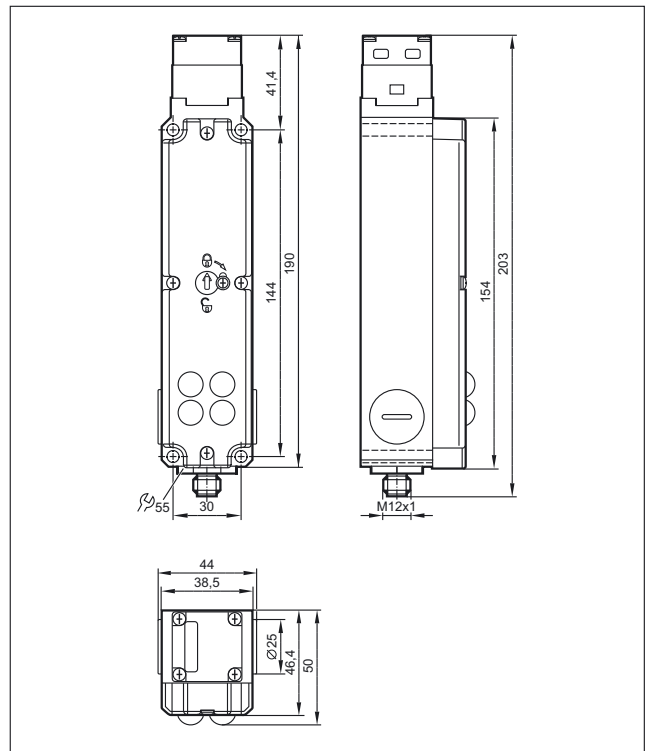



Process sensors

Measuring and monitoring fluids – now also with IO-Link



Multiple features

ifm process sensors can be used for control and measurement of the most important parameters of fluids –no matter whether it is pressure, level, flow, temperature or valve position. The range of applications spans from simple monitoring tasks and presence detection of media to accurate and highly repeatable measurements.

The applied microprocessor technology allows for a selection of key parameter settings. In addition to local parameter setting, IO-Link compatible sensors provide an easy way of communication while their parameters can be set directly from the controller. For further data processing, switching and analogue outputs are available. The transmission of data to the controller can also be achieved via bus systems (AS-i). Process and set parameters are indicated locally by a 4-digit alphanumeric display.

As the sensors are mostly in direct contact with the medium, the design of the units and the selection of the materials were driven by the high requirements in the applications.

These include in particular resistance to pressure, vibration, shock, media and temperature as well as electromagnetic compatibility and a high protection rating.







Multiple applications

The broad range of ifm sensors can be used across many different applications. The main areas of application are machine building, hygienic applications (e.g. in the food industry), mobile machines and industrial or chemical process plants.

An extensive range of process adapters and mounting accessories guarantees easy integration of the sensors into the application.

Moreover, the units comply with required approvals such as EHEDG, 3A, FDA, KTW, ATEX and e1 for safe use in the application.

Regular examinations in production and high test requirements at the development stage ensure a consistently high quality.

	Pressure sensors	448 - 483
	Flow sensors / flow meters	484 - 517
	Level sensors	518 - 543
	Temperature sensors	544 - 578
	Signal evaluation systems	580 - 585
	Feedback systems for valves and valve actuators	586 - 599



Process sensors

Robust pressure sensors and transmitters for flexible use



Pressure sensors



Sensors and transmitters with integrated evaluation

Units with special design for hygienic applications

Overload-protected measuring principles with a good long-term stability

Measuring ranges of -1...600 bar

Variable process connection and sealing technology via adapters

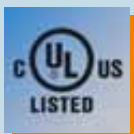
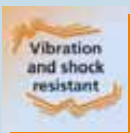

Pressure sensors

All units have robust housings and do not require moving parts such as pistons or springs. The result: the sensors are extremely shock and vibration resistant and operate without any wear and tear or maintenance.

The tried and tested ceramic-capacitive measuring cell is corrosion-resistant and long-term stable. This ensures consistent and long-term accuracy of the measured values. The sensors are resistant to dynamic pressure peaks and have a high overload protection.

The units featuring a stainless steel measuring cell are distinguished by their very compact and robust design. The welded stainless steel measuring cell without any seals ensures a high degree of safety, in particular for applications with gas pressures of up to 600 bar as well as in air-conditioning and refrigerating technology where aggressive coolants (freons) are used.

System overview	Page
Sensors with switching and analogue outputs, display and IO-Link	450 - 452
Sensors with switching outputs and display with IO-Link	452 - 453
Electronic contact manometers with switching output and analogue output	453 - 454
PV sensors with switching outputs, IO-Link	454 - 455
PK sensors with mechanical setting and switching outputs	455 - 456
PP sensors for mobile and industrial applications with switching outputs, IO-Link	456 - 457
Sensors for pneumatic applications	457
Absolute pressure sensors with analogue outputs for industrial applications	458
PT sensors for industrial applications with analogue outputs	458 - 459
PT / PU sensors for mobile applications with analogue outputs	460 - 463
PA sensors with analogue outputs	463 - 465
Part seat monitoring	465
Sensors for hydrostatic level monitoring	465 - 466
Sensors for hydrostatic level monitoring ATEX category 1G/1D	466
Sensors with ATEX approval 3D/3G	467
Full metal sensors for hygienic and wet areas with switching and analogue outputs, IO-Link	467 - 468
Full-metal high-temperature sensors up to 200 °C for hygienic and wet areas with switching output and analogue output, IO-Link	468 - 469
Electronic contact manometers for hygienic and wet areas with switching and analogue outputs	469 - 470
PF sensors for hygienic and wet areas with switching and analogue outputs	470
Fixing components for pressure sensors	471
Software	471
Certificates	471
Accessories for pressure sensors	471 - 473
Accessories	473
Adapters and accessories for adapters	473 - 474
Flange adapters	474 - 477
Wiring diagrams	477 - 478
Scale drawings / drawing no. – CAD download: www.ifm.com	479 - 483



Process sensors

Sensors with switching and analogue outputs, display and IO-Link

Type	Process connection	Display	Measuring range [bar]	P _{overload} max. [bar]	P _{bursting} min. [bar]	U _b DC [V]	Draw- ing no.	Order no.
------	--------------------	---------	--------------------------	-------------------------------------	-------------------------------------	-----------------------------	---------------------	--------------

M12 connector · Output function 2 x normally open / closed progr. or 1 x normally open / closed progr. + 1 x analogue (4...20 mA / 0...10 V; scaleable 1:5) · Wiring diagram no. 1 · Connector groups 8, 10, 19, 21, 23, 25, 148, 149, 153, 184, 188, 193, 202



	G ¼ I	Display unit	0...600	800	2500	18...30	1	PN2160
	G ¼ I	Display unit	0...400	800	1700	18...30	1	PN2070
	G ¼ I	Display unit	0...250	500	1200	18...30	1	PN2071
	G ¼ I	Display unit	0...100	300	650	18...30	1	PN2092
	G ¼ I	Display unit	-1...25	150	350	18...30	1	PN2093
	G ¼ I	Display unit	-1...10	75	150	18...30	1	PN2094
	G ¼ I	Display unit	-0.125...2.5	20	50	18...30	1	PN2096
	G ¼ I	Display unit	-0.05...1	10	30	18...30	1	PN2097
	G ¼ I	Display unit	-0.0125...25	10	30	18...30	1	PN2098
	G ¼ I	Display unit	-1...1	20	50	18...30	1	PN2099
	G ¼ I	Display unit	-0.5...0.5	10	30	18...30	1	PN2169
	G ¼ A / M5 I	Display unit	0...600	800	2500	18...30	2	PN2560
	G ¼ A / M5 I	Display unit	0...400	800	1700	18...30	2	PN2570
	G ¼ A / M5 I	Display unit	0...250	500	1200	18...30	2	PN2571
	G ¼ A / M5 I	Display unit	0...100	300	650	18...30	2	PN2592
	G ¼ A / M5 I	Display unit	-1...25	150	350	18...30	2	PN2593

Type	Process connection	Display	Measuring range [bar]	P _{overload} max. [bar]	P _{bursting} min. [bar]	U _b DC [V]	Draw- ing no.	Order no.
------	--------------------	---------	--------------------------	-------------------------------------	-------------------------------------	-----------------------------	---------------------	--------------

M12 connector · Output function 2 x normally open / closed progr. or 1 x normally open / closed progr. + 1 x analogue (4...20 mA / 0...10 V; scaleable 1:5) · Wiring diagram no. 1 · Connector groups 8, 10, 19, 21, 23, 25, 148, 149, 153, 184, 188, 193, 202

	G ¼ A / M5 I	Display unit	-1...10	75	150	18...30	2	PN2594
	G ¼ A / M5 I	Display unit	-0.125...2.5	20	50	18...30	2	PN2596
	G ¼ A / M5 I	Display unit	-0.05...1	10	30	18...30	2	PN2597
	G ¼ A / M5 I	Display unit	-0.0125...0.25	10	30	18...30	2	PN2598
	G ¼ A / M5 I	Display unit	-1...1	20	50	18...30	2	PN2599
	G ¼ A / M5 I	Display unit	-0.5...0.5	10	30	18...30	2	PN2569

M12 connector · Output function normally open / closed programmable; 4...20 mA or 0...10 V · Wiring diagram no. 1 · Connector groups 8, 10, 19, 21, 23, 25, 148, 149, 153, 184, 188, 193, 202

	G ¼ I	Display unit	0...600	800	2500	18...30	1	PN3160
	G ¼ I	Display unit	0...400	800	1700	18...30	1	PN3070
	G ¼ I	Display unit	0...250	500	1200	18...30	1	PN3071
	G ¼ I	Display unit	0...100	300	650	18...30	1	PN3092
	G ¼ I	Display unit	0...25	150	350	18...30	1	PN3093
	G ¼ I	Display unit	-1...10	75	150	18...30	1	PN3094
	G ¼ I	Display unit	0...2.5	20	50	18...30	1	PN3096
	G ¼ I	Display unit	0...1	10	30	18...30	1	PN3097
	G ¼ I	Display unit	-1...0	20	50	18...30	1	PN3129
	G ¼ A / M5 I	Display unit	0...600	800	2500	18...30	2	PN3560



Process sensors



Type	Process connection	Display	Measuring range [bar]	P _{overload} max. [bar]	P _{bursting} min. [bar]	U _b DC [V]	Draw- ing no.	Order no.
M12 connector · Output function normally open / closed programmable; 4...20 mA or 0...10 V · Wiring diagram no. 1 · Connector groups 8, 10, 19, 21, 23, 25, 148, 149, 153, 184, 188, 193, 202								
	G ¼ A / M5 I	Display unit	0...400	800	1700	18...30	2	PN3570
	G ¼ A / M5 I	Display unit	0...250	500	1200	18...30	2	PN3571
	G ¼ A / M5 I	Display unit	0...100	300	650	18...30	2	PN3592
	G ¼ A / M5 I	Display unit	0...25	150	350	18...30	2	PN3593
	G ¼ A / M5 I	Display unit	0...10	75	150	18...30	2	PN3594
	G ¼ A / M5 I	Display unit	0...2.5	20	50	18...30	2	PN3596
	G ¼ A / M5 I	Display unit	0...1	10	30	18...30	2	PN3597
	G ¼ A / M5 I	Display unit	-1...0	20	50	18...30	2	PN3529

Sensors with switching outputs and display with IO-Link

Type	Process connection	Display	Measuring range [bar]	P _{overload} max. [bar]	P _{bursting} min. [bar]	U _b DC [V]	Draw- ing no.	Order no.
M12 connector · Output function 2 x normally open / closed programmable · DC PNP/NPN · Wiring diagram no. 1 · Connector groups 8, 9, 10, 11, 18, 19, 21, 23, 25, 148, 149, 150, 151, 153, 154, 184, 188, 190, 193, 202, 203, 204								
	G ¼ I	Display unit	0...600	800	2500	18...30	1	PN7160
	G ¼ I	Display unit	0...400	800	1700	18...30	1	PN7070
	G ¼ I	Display unit	0...250	500	1100	18...30	1	PN7071
	G ¼ I	Display unit	0...100	300	650	18...30	1	PN7092
	G ¼ I	Display unit	0...25	150	350	18...30	1	PN7093
	G ¼ I	Display unit	-1...10	75	150	18...30	1	PN7094

Type	Process connection	Display	Measuring range [bar]	P _{overload} max. [bar]	P _{bursting} min. [bar]	U _b DC [V]	Draw- ing no.	Order no.
------	--------------------	---------	--------------------------	-------------------------------------	-------------------------------------	-----------------------------	---------------------	--------------

M12 connector · Output function 2 x normally open / closed programmable · DC PNP/NPN · Wiring diagram no. 1 · Connector groups 8, 9, 10, 11, 18, 19, 21, 23, 25, 148, 149, 150, 151, 153, 154, 184, 188, 190, 193, 202, 203, 204

	G ¼ I	Display unit	0...2.5	20	50	18...30	1	PN7096
	G ¼ I	Display unit	0...1	10	30	18...30	1	PN7097
	G ¼ I	Display unit	-1...1	20	50	18...30	1	PN7099
	G ¼ A / M5 I	Display unit	0...600	800	2500	18...30	2	PN7560
	G ¼ A / M5 I	Display unit	0...400	800	1700	18...30	2	PN7570
	G ¼ A / M5 I	Display unit	0...250	500	1100	18...30	2	PN7571
	G ¼ A / M5 I	Display unit	0...100	300	650	18...30	2	PN7592
	G ¼ A / M5 I	Display unit	0...25	150	350	18...30	2	PN7593
	G ¼ A / M5 I	Display unit	-1...10	75	150	18...30	2	PN7594
	G ¼ A / M5 I	Display unit	0...2.5	20	50	18...30	2	PN7596
	G ¼ A / M5 I	Display unit	0...1	10	30	18...30	2	PN7597
	G ¼ A / M5 I	Display unit	-1...1	20	50	18...30	2	PN7599

Electronic contact manometers with switching output and analogue output

Type	Process connection	Display	Measuring range [bar]	P _{overload} max. [bar]	P _{bursting} min. [bar]	U _b DC [V]	Draw- ing no.	Order no.
------	--------------------	---------	--------------------------	-------------------------------------	-------------------------------------	-----------------------------	---------------------	--------------

M12 connector · Output function 1 x normally open / closed programmable + 1 x analogue (4...20 / 20...4 mA, scalable) · DC PNP/NPN · Wiring diagram no. 17 · Connector groups 8, 10, 19, 21, 23, 25, 148, 149, 153, 184, 188, 193, 202

	G ½ A	Display unit	0...400	800	1200	18...32	3	PG2450
	G ½ A	Display unit	0...250	600	1000	18...32	3	PG2451



Process sensors

Type	Process connection	Display	Measuring range [bar]	P _{overload} max. [bar]	P _{bursting} min. [bar]	U _b DC [V]	Draw- ing no.	Order no.
M12 connector · Output function 1 x normally open / closed programmable + 1 x analogue (4...20 / 20...4 mA, scalable) · DC PNP/NPN · Wiring diagram no. 17 · Connector groups 8, 10, 19, 21, 23, 25, 148, 149, 153, 184, 188, 193, 202								
	G ½ A	Display unit	0...100	300	700	18...32	3	PG2452
	G ½ A	Display unit	-1...25	100	300	18...32	3	PG2453
	G ½ A	Display unit	-1...10	50	150	18...32	3	PG2454
	G ½ A	Display unit	-1...4	30	100	18...32	3	PG2455
	G ½ A	Display unit	-0.125...2.5	20	50	18...32	3	PG2456
	G ½ A	Display unit	-0.05...1	10	30	18...32	3	PG2457
	G ½ A	Display unit	-0.0125...0.25	10	30	18...32	3	PG2458
	G ½ A	Display unit	-0.005...0.1	4	30	18...32	3	PG2489
	G ½ A	Display unit	-1...1	10	30	18...32	3	PG2409

PV sensors with switching outputs, IO-Link

Type	Process connection	Display	Measuring range [bar]	P _{overload} max. [bar]	P _{bursting} min. [bar]	U _b DC [V]	Draw- ing no.	Order no.
M12 connector · Output function 2 x normally open / closed programmable · DC PNP/NPN · Wiring diagram no. 1 · Connector groups 8, 10, 19, 21, 23, 25, 148, 149, 153, 184, 188, 193, 202								
	G ¼ A / M5 I	–	0...400	1000	1700	18...30	4	PV7000
	G ¼ A / M5 I	–	0...250	625	1200	18...30	4	PV7001
	G ¼ A / M5 I	–	0...100	250	1000	18...30	4	PV7002
	G ¼ A / M5 I	–	0...60	150	900	18...30	4	PV7023
	G ¼ A / M5 I	–	-1...25	65	600	18...30	4	PV7003

Type	Process connection	Display	Measuring range [bar]	P _{overload} max. [bar]	P _{bursting} min. [bar]	U _b DC [V]	Draw- ing no.	Order no.
------	--------------------	---------	--------------------------	-------------------------------------	-------------------------------------	-----------------------------	---------------------	--------------

M12 connector · Output function 2 x normally open / closed programmable · DC PNP/NPN · Wiring diagram no. 1 · Connector groups 8, 10, 19, 21, 23, 25, 148, 149, 153, 184, 188, 193, 202

	G ¼ A / M5 I	–	-1...10	25	300	18...30	4	PV7004
---	--------------	---	---------	----	-----	---------	---	--------

PK sensors with mechanical setting and switching outputs

Type	Process connection	Display	Measuring range [bar]	P _{overload} max. [bar]	P _{bursting} min. [bar]	U _b DC [V]	Draw- ing no.	Order no.
------	--------------------	---------	--------------------------	-------------------------------------	-------------------------------------	-----------------------------	---------------------	--------------

M12 connector · Output function  · DC PNP · Wiring diagram no. 2 · Connector groups 8, 9, 10, 11, 18, 19, 21, 23, 25, 148, 149, 150, 151, 153, 154, 184, 188, 190, 193, 202, 203, 204

	G ¼ A / M5 I	Operation	0...400	600	1600	9.6...32	5	PK5520
	G ¼ A / M5 I	Operation	0...250	400	1000	9.6...32	5	PK5521
	G ¼ A / M5 I	Operation	0...100	200	1000	9.6...32	5	PK5522
	G ¼ A / M5 I	Operation	0...25	60	500	9.6...32	5	PK5523
	G ¼ A / M5 I	Operation	0...10	25	300	9.6...32	5	PK5524

M12 connector · Output function  · DC PNP · Wiring diagram no. 3 · Connector groups 8, 9, 10, 11, 18, 19, 21, 23, 25, 148, 149, 150, 151, 153, 154, 184, 188, 190, 193, 202, 203, 204

	G ¼ A / M5 I	Operation	0...400	600	1600	9.6...32	5	PK6520
	G ¼ A / M5 I	Operation	0...250	400	1000	9.6...32	5	PK6521
	G ¼ A / M5 I	Operation	0...100	200	1000	9.6...32	5	PK6522
	G ¼ A / M5 I	Operation	0...25	60	500	9.6...32	5	PK6523
	G ¼ A / M5 I	Operation	0...10	25	300	9.6...32	5	PK6524

M12 connector · Output function  · DC PNP · Wiring diagram no. 4 · Connector groups 8, 9, 10, 11, 18, 19, 21, 23, 25, 148, 149, 150, 151, 153, 154, 184, 188, 190, 193, 202, 203, 204

	G ¼ A / M5 I	Switching status	0...400	600	1600	9.6...32	5	PK7520
---	--------------	------------------	---------	-----	------	----------	---	--------



Process sensors

Type	Process connection	Display	Measuring range [bar]	P _{overload} max. [bar]	P _{bursting} min. [bar]	U _b DC [V]	Draw- ing no.	Order no.
------	--------------------	---------	--------------------------	-------------------------------------	-------------------------------------	-----------------------------	---------------------	--------------

M12 connector · Output function · DC PNP · Wiring diagram no. 4 · Connector groups 8, 9, 10, 11, 18, 19, 21, 23, 25, 148, 149, 150, 151, 153, 154, 184, 188, 190, 193, 202, 203, 204

	G ¼ A / M5 I	Switching status	0...250	400	1000	9.6...32	5	PK7521
	G ¼ A / M5 I	Switching status	0...100	200	1000	9.6...32	5	PK7522
	G ¼ A / M5 I	Switching status	0...25	60	500	9.6...32	5	PK7523
	G ¼ A / M5 I	Switching status	0...10	25	300	9.6...32	5	PK7524

PP sensors for mobile and industrial applications with switching outputs, IO-Link

Type	Process connection	Display	Measuring range [bar]	P _{overload} max. [bar]	P _{bursting} min. [bar]	U _b DC [V]	Draw- ing no.	Order no.
------	--------------------	---------	--------------------------	-------------------------------------	-------------------------------------	-----------------------------	---------------------	--------------

M12 connector · Output function 2 x normally open / closed programmable or 1 x normally open / closed programmable + 1 x normally closed (diagnostic function) · DC PNP · Wiring diagram no. 5 · Connector groups 8, 9, 10, 11, 18, 19, 21, 23, 25, 148, 149, 150, 151, 153, 154, 184, 188, 190, 193, 202, 203, 204

	G ¼ A / M5 I	Operation	0...400	600	1000	9.6...36	6	PP7550
	G ¼ A / M5 I	Operation	0...250	400	850	9.6...36	6	PP7551
	G ¼ A / M5 I	Operation	0...100	300	650	9.6...36	7	PP7552
	G ¼ A / M5 I	Operation	0...25	150	350	9.6...36	8	PP7553
	G ¼ A / M5 I	Operation	-1...10	75	150	9.6...36	8	PP7554
	G ¼ A / M5 I	Operation	0...2.5	20	50	9.6...36	8	PP7556

M12 connector · Output function 2 x normally open / closed programmable or 1 x normally open / closed programmable + 1 x normally closed (diagnostic function) · DC NPN · Wiring diagram no. 5 · Connector groups 8, 9, 10, 11, 18, 19, 21, 23, 25, 148, 149, 150, 151, 153, 154, 184, 188, 190, 193, 202, 203, 204

	G ¼ A / M5 I	Operation	0...400	600	1000	9.6...36	6	PP0520
	G ¼ A / M5 I	Operation	0...250	400	850	9.6...36	6	PP0521
	G ¼ A / M5 I	Operation	0...100	300	650	9.6...36	7	PP0522

Type	Process connection	Display	Measuring range [bar]	P _{overload} max. [bar]	P _{bursting} min. [bar]	U _b DC [V]	Draw- ing no.	Order no.
------	--------------------	---------	--------------------------	-------------------------------------	-------------------------------------	-----------------------------	---------------------	--------------

M12 connector · Output function 2 x normally open / closed programmable or 1 x normally open / closed programmable + 1 x normally closed (diagnostic function) · DC NPN · Wiring diagram no. 5 · Connector groups 8, 9, 10, 11, 18, 19, 21, 23, 25, 148, 149, 150, 151, 153, 154, 184, 188, 190, 193, 202, 203, 204

	G ¼ A / M5 I	Operation	0...25	150	350	9.6...36	8	PP0523
	G ¼ A / M5 I	Operation	-1...10	75	150	9.6...36	8	PP0524

Sensors for pneumatic applications

Type	Process connection	Display	Measuring range [bar]	P _{overload} max. [bar]	P _{bursting} min. [bar]	U _b DC [V]	Draw- ing no.	Order no.
------	--------------------	---------	--------------------------	-------------------------------------	-------------------------------------	-----------------------------	---------------------	--------------

M12 connector · Output function 2 x normally open / closed programmable or 1 x normally open / closed programmable + 1 x normally closed (diagnostic function) · DC PNP/NPN · Wiring diagram no. 18 · Connector groups 8, 9, 10, 11, 18, 19, 21, 23, 25, 148, 149, 150, 151, 153, 154, 184, 188, 190, 193, 202, 203, 204

	G 1/8 I	Display unit	-1...1	20	30	18...36	9	PN7809
	G 1/8 I	Display unit	-1...10	20	30	18...36	9	PN7834

M8 connector · Output function 2 x normally open / closed programmable or 1 x normally open / closed programmable + 1 x normally closed (diagnostic function) · DC PNP · Wiring diagram no. 4 · Connector groups 4, 5, 80, 86, 147

	G 1/8 I	Display unit	-1...1	20	30	18...32	10	PQ7809
	G 1/8 I	Display unit	-1...10	20	30	18...32	10	PQ7834

M8 connector · Output function 2 x normally open / closed programmable or 1 x normally open / closed programmable + 1 x normally closed (diagnostic function) · DC NPN · Wiring diagram no. 6 · Connector groups 4, 5, 80, 86, 147

	G 1/8 I	Display unit	-1...1	20	30	18...32	10	PQ0809
	G 1/8 I	Display unit	-1...10	20	30	18...32	10	PQ0834





M8 connector · Output function 1 x NO / NC programmable + 1 x current output · DC PNP · Wiring diagram no. 7 · Connector groups 4, 5, 80, 86, 147

	G 1/8 I / M5 I	Display unit	-1...1	20	30	18...32	11	PQ3809
	G 1/8 I / M5 I	Display unit	-1...10	20	30	18...32	11	PQ3834









Process sensors

Absolute pressure sensors with analogue outputs for industrial applications

Type	Process connection	Display	Measuring range [bar]	P _{overload} max. [bar]	P _{bursting} min. [bar]	U _b DC [V]	Draw- ing no.	Order no.
	G ¼ A	–	0...10	20	50	8...30	12	PT0504
	G ¼ A	–	0...4	8	25	8...30	12	PT0505
	G ¼ A	–	0...1.6	3.2	10	8...30	12	PT0517
	G ¼ A	–	0...1	2	5	8...30	12	PT0507

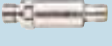
M12 connector · Output function 4...20 mA analogue · DC · Wiring diagram no. 8 · Connector groups 8, 10, 19, 21, 23, 25, 148, 149, 153, 184, 188, 193, 202

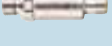

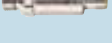

PT sensors for industrial applications with analogue outputs

Type	Process connection	Display	Measuring range [bar]	P _{overload} max. [bar]	P _{bursting} min. [bar]	U _b DC [V]	Draw- ing no.	Order no.
	G ¼ A	–	0...600	1500	2500	8.5...36	4	PT5460
	G ¼ A	–	0...400	1000	1700	8.5...36	4	PT5400
	G ¼ A	–	0...250	625	1200	8.5...36	4	PT5401
	G ¼ A	–	0...160	400	1100	8.5...36	4	PT5412
	G ¼ A	–	0...100	250	1000	8.5...36	4	PT5402
	G ¼ A	–	0...60	150	900	8.5...36	4	PT5423
	G ¼ A	–	0...40	100	800	8.5...36	4	PT5443
	G ¼ A	–	0...25	65	600	8.5...36	4	PT5403



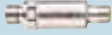







M12 connector · Output function 4...20 mA analogue · DC · Wiring diagram no. 8 · Connector groups 8, 10, 19, 21, 23, 25, 148, 149, 153, 184, 188, 193, 202

Type	Process connection	Display	Measuring range [bar]	P _{overload} max. [bar]	P _{bursting} min. [bar]	U _b DC [V]	Draw- ing no.	Order no.
------	--------------------	---------	--------------------------	-------------------------------------	-------------------------------------	-----------------------------	---------------------	--------------

M12 connector · Output function 4...20 mA analogue · DC · Wiring diagram no. 8 · Connector groups 8, 10, 19, 21, 23, 25, 148, 149, 153, 184, 188, 193, 202

	G ¼ A	–	0...16	40	450	8.5...36	4	PT5414
	G ¼ A	–	0...10	25	300	8.5...36	4	PT5404
	G ¼ A	–	-1...10	25	300	8.5...36	4	PT5494
	G ¼ A	–	0...6	15	200	8.5...36	4	PT5415

M12 connector · Output function 0...10 V analogue · DC · Wiring diagram no. 9 · Connector groups 8, 10, 19, 21, 23, 25, 148, 149, 153, 184, 188, 193, 202

	G ¼ A	–	0...600	1500	2500	16...36	4	PU5460
	G ¼ A	–	0...400	1000	1700	16...36	4	PU5400
	G ¼ A	–	0...250	625	1200	16...36	4	PU5401
	G ¼ A	–	0...160	400	1100	16...36	4	PU5412
	G ¼ A	–	0...100	250	1000	16...36	4	PU5402
	G ¼ A	–	0...60	150	900	16...36	4	PU5423
	G ¼ A	–	0...40	100	800	16...36	4	PU5443
	G ¼ A	–	0...25	65	600	16...36	4	PU5403
	G ¼ A	–	0...16	40	450	16...36	4	PU5414
	G ¼ A	–	0...10	25	300	16...36	4	PU5404
	G ¼ A	–	0...6	15	200	16...36	4	PU5415



Process sensors







PT / PU sensors for mobile applications with analogue outputs

Type	Process connection	Display	Measuring range [bar]	P _{overload} max. [bar]	P _{bursting} min. [bar]	U _b DC [V]	Drawing no.	Order no.
------	--------------------	---------	--------------------------	-------------------------------------	-------------------------------------	-----------------------------	----------------	--------------



M12 connector · Output function 0...10 V analogue · DC · Wiring diagram no. 10 · Connector group 202













	G ¼ A	–	0...400	600	1600	16...36	13	PT9550
	G ¼ A	–	0...250	400	1000	16...36	13	PT9551
	G ¼ A	–	0...100	200	1000	16...36	13	PT9552
	G ¼ A	–	0...25	60	600	16...36	13	PT9553
	G ¼ A	–	0...10	25	300	16...36	13	PT9554

DEUTSCH connector DT04-3P · Output function 0...10 V analogue · DC · Wiring diagram no. 11

	G ¼ A	–	0...600	1500	2500	16...32	14	PU5760
	G ¼ A	–	0...400	1000	1700	16...32	14	PU5700
	G ¼ A	–	0...250	625	1200	16...32	14	PU5701
	G ¼ A	–	0...100	250	1000	16...32	14	PU5702
	G ¼ A	–	0...25	65	600	16...32	14	PU5703
	G ¼ A	–	0...10	25	300	16...32	14	PU5704

DEUTSCH connector DT04-3P · DC · Wiring diagram no. 11

	G ¼	–	0...400	1000	1700	8...32	14	PU8700
	G ¼	–	0...250	625	1200	8...32	14	PU8701
	G ¼	–	0...100	250	1000	8...32	14	PU8702

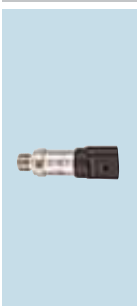
Type	Process connection	Display	Measuring range [bar]	P _{overload} max. [bar]	P _{bursting} min. [bar]	U _b DC [V]	Draw- ing no.	Order no.
DEUTSCH connector DT04-3P · DC · Wiring diagram no. 11								
	G ¼	–	0...25	65	600	8...32	14	PU8703
	G ¼	–	0...10	25	300	8...32	14	PU8704
	G ¼	–	0...160	400	1100	8...32	14	PU8712
	G ¼	–	0...40	100	800	8...32	14	PU8743
	G ¼	–	0...600	1500	2500	8...32	14	PU8760
M12 connector · Output function 0.5...4.5 V · DC · Wiring diagram no. 9 · Connector groups 8, 10, 19, 21, 23, 25, 148, 149, 153, 184, 188, 193, 202								
	G ¼ A	–	0...400	1000	1700	8...32	4	PU8500
	G ¼ A	–	0...250	625	1200	8...32	4	PU8501
	G ¼ A	–	0...100	250	1000	8...32	4	PU8502
	G ¼ A	–	0...60	65	600	8...32	4	PU8503
	G ¼ A	–	0...10	25	300	8...32	4	PU8504
	G ¼ A	–	0...60	150	900	8...32	4	PU8523
	G ¼ A	–	0...600	1500	2500	8...32	4	PU8560
AMP Superseal · Output function 0...10 V analogue · DC · Wiring diagram no. 12								
	G ¼ A	–	0...600	1500	2500	16...32	15	PU5660
	G ¼ A	–	0...400	1000	1700	16...32	15	PU5600
	G ¼ A	–	0...250	625	1200	16...32	15	PU5601

You can find wiring diagrams and scale drawings from page 477









Process sensors

Type	Process connection	Display	Measuring range [bar]	P _{overload} max. [bar]	P _{bursting} min. [bar]	U _b DC [V]	Draw- ing no.	Order no.
------	--------------------	---------	--------------------------	-------------------------------------	-------------------------------------	-----------------------------	---------------------	--------------

AMP Superseal · Output function 0...10 V analogue · DC · Wiring diagram no. 12







	G ¼ A	–	0...100	250	1000	16...32	15	PU5602
	G ¼ A	–	0...25	65	600	16...32	15	PU5603
	G ¼ A	–	0...10	25	300	16...32	15	PU5604

M12 connector · Output function 4...20 mA analogue · DC · Wiring diagram no. 8 · Connector groups 8, 10, 19, 21, 23, 25, 148, 149, 153, 184, 188, 193, 202

	G ¼ A	–	0...600	1500	2500	8...32	4	PT5560
	G ¼ A	–	0...400	1000	1700	8...32	4	PT5500
	G ¼ A	–	0...250	625	1200	8...32	4	PT5501
	G ¼ A	–	0...100	250	1000	8...32	4	PT5502
	G ¼ A	–	0...25	65	600	8...32	4	PT5503
	G ¼ A	–	0...10	25	300	8...32	4	PT5504

AMP Superseal · Output function 0...10 V analogue · DC · Wiring diagram no. 12

	G ¼ A	–	0...400	1000	1700	16...32	15	PU5600
	G ¼ A	–	0...250	625	1200	16...32	15	PU5601
	G ¼ A	–	0...100	250	1000	16...32	15	PU5602
	G ¼ A	–	0...25	65	600	16...32	15	PU5603
	G ¼ A	–	0...10	25	300	16...32	15	PU5604
	G ¼ A	–	0...600	1500	2500	16...32	15	PU5660





Type	Process connection	Display	Measuring range [bar]	P _{overload} max. [bar]	P _{bursting} min. [bar]	U _b DC [V]	Draw- ing no.	Order no.
DEUTSCH connector DT04-3P · Output function 4...20 mA analogue · DC · Wiring diagram no. 13								
	G ¼ A	–	0...400	1000	1700	8...32	14	PT5700
	G ¼ A	–	0...250	625	1200	8...32	14	PT5701
	G ¼ A	–	0...100	250	1000	8...32	14	PT5702
	G ¼ A	–	0...25	65	600	8...32	14	PT5703
	G ¼ A	–	0...10	25	300	8...32	14	PT5704
	G ¼ A	–	0...600	1500	2500	8...32	14	PT5760

PA sensors with analogue outputs

Type	Process connection	Display	Measuring range [bar]	P _{overload} max. [bar]	P _{bursting} min. [bar]	U _b DC [V]	Draw- ing no.	Order no.
M12 connector · Output function 4...20 mA · DC · Wiring diagram no. 14 · Connector groups 8, 10, 19, 21, 23, 25, 148, 149, 153, 184, 188, 193, 202								
	G ¼ I	–	0...600	800	1200	9.6...32	16	PA3060
	G ¼ I	–	0...400	600	1000	9.6...32	17	PA3020
	G ¼ I	–	0...250	400	850	9.6...32	17	PA3021
	G ¼ I	–	0...100	300	650	9.6...32	18	PA3022
	G ¼ I	–	0...25	150	350	9.6...32	18	PA3023
	G ¼ I	–	0...10	75	150	9.6...32	18	PA3024
	G ¼ I	–	0...2.5	20	50	9.6...32	18	PA3026



Process sensors

Type	Process connection	Display	Measuring range [bar]	P _{overload} max. [bar]	P _{bursting} min. [bar]	U _b DC [V]	Draw- ing no.	Order no.
M12 connector · Output function 4...20 mA · DC · Wiring diagram no. 14 · Connector groups 8, 10, 19, 21, 23, 25, 148, 149, 153, 184, 188, 193, 202								
	G 1/4 I	–	0...1	10	30	9.6...32	18	PA3027
	G 1/4 I	–	0...0.25	10	30	9.6...32	18	PA3028
	G 1/4 I	–	-1...0	10	30	9.6...32	18	PA3029
M12 connector · Output function 4...20 mA · DC · Wiring diagram no. 8 · Connector groups 8, 10, 19, 21, 23, 25, 148, 149, 153, 184, 188, 193, 202								
	G 1/4 A / M5 I	–	0...250	400	850	9.6...32	19	PA3521
	G 1/4 A / M5 I	–	0...100	300	650	9.6...32	19	PA3522
M12 connector · Output function 4...20 mA · DC · Wiring diagram no. 14 · Connector groups 8, 10, 19, 21, 23, 25, 148, 149, 153, 184, 188, 193, 202								
	G 1/4 A / M5 I	–	0...25	150	350	9.6...32	19	PA3523
	G 1/4 A / M5 I	–	0...10	75	150	9.6...32	19	PA3524
	G 1/4 A / M5 I	–	0...2.5	20	50	9.6...32	19	PA3526
	G 1/4 A / M5 I	–	0...0.25	10	30	9.6...32	19	PA3528
M12 connector · Output function 4...20 mA · DC · Wiring diagram no. 8 · Connector groups 8, 10, 19, 21, 23, 25, 148, 149, 153, 184, 188, 193, 202								
	G 1/4 A / M5 I	–	0...0.1	4	30	9.6...32	19	PA3589
M12 connector · Output function 0...10 V · DC · Wiring diagram no. 10 · Connector groups 8, 10, 19, 21, 23, 25, 148, 149, 153, 184, 188, 193, 202								
	G 1/4 I	–	0...600	800	1200	16...32	16	PA9060
	G 1/4 I	–	0...400	600	1000	16...32	17	PA9020
	G 1/4 I	–	0...250	400	850	16...32	18	PA9021
	G 1/4 I	–	0...100	300	650	16...32	18	PA9022

Type	Process connection	Display	Measuring range [bar]	P _{overload} max. [bar]	P _{bursting} min. [bar]	U _b DC [V]	Draw- ing no.	Order no.
M12 connector · Output function 0...10 V · DC · Wiring diagram no. 10 · Connector groups 8, 10, 19, 21, 23, 25, 148, 149, 153, 184, 188, 193, 202								
	G ¼ I	–	0...25	150	350	16...32	18	PA9023
	G ¼ I	–	0...10	75	150	16...32	18	PA9024
	G ¼ I	–	0...2.5	20	50	16...32	18	PA9026
	G ¼ I	–	0...1	10	30	16...32	18	PA9027
	G ¼ I	–	0...0.25	10	30	16...32	18	PA9028
	G ¼ I	–	-1...0	10	30	16...32	18	PA9029

Part seat monitoring

Type	Description	Order no.
	Control unit for part seat monitoring · Setting by adjustment of the pneumatic bridge · Integrated pressure sensor with 2 switching outputs · and 4-digit alphanumeric display for trend display or display of current pressure · Cable	PS7570

Sensors for hydrostatic level monitoring

Type	Measuring range [bar]	Cable length / material	P _{overload} max. [bar]	P _{bursting} min. [bar]	U _b DC [V]	Draw- ing no.	Order no.
Output function 4...20 mA analogue · Wiring diagram no. 15							
	0...0.25	5 m PUR cable	2	2.4	10...30	20	PS3208
	0...0.6	10 m PUR cable	4	4.8	10...30	20	PS3407
	0...0.6	15 m PUR cable	4	4.8	10...30	20	PS3427
	0...0.6	30 m PUR cable	4	4.8	10...30	20	PS3607
	0...1	15 m PUR cable	5	6	10...30	20	PS3417

You can find wiring diagrams and scale drawings from page 477



Process sensors

Type	Measuring range [bar]	Cable length / material	P _{overload} max. [bar]	P _{bursting} min. [bar]	U _b DC [V]	Draw- ing no.	Order no.
------	--------------------------	----------------------------	-------------------------------------	-------------------------------------	-----------------------------	---------------------	--------------

Output function 4...20 mA analogue · Wiring diagram no. 15

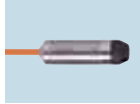
	0...1	30 m PUR cable	5	6	10...30	20	PS3617
---	-------	-------------------	---	---	---------	----	---------------

Output function 4...20 mA analogue · Wiring diagram no. 16

	0...0.25	5 m FEP cable	2	2.4	10...30	21	PS4208
	0...0.25	10 m FEP cable	2	2.4	10...30	21	PS4408
	0...0.6	10 m FEP cable	3	4	10...30	21	PS4407
	0...0.6	20 m FEP cable	3	4	10...30	21	PS4506

· Wiring diagram no. 16

	0...1	15 m FEP cable	5	6	10...30	21	PS4417
	0...1	30 m FEP cable	5	6	10...30	21	PS4607

Sensors for hydrostatic level monitoring ATEX category 1G/1D

Type	Measuring range [bar]	Cable length / material	P _{overload} max. [bar]	P _{bursting} min. [bar]	U _b DC [V]	Draw- ing no.	Order no.
------	--------------------------	----------------------------	-------------------------------------	-------------------------------------	-----------------------------	---------------------	--------------

Output function 4...20 mA analogue · Wiring diagram no. 16

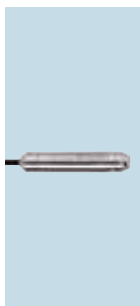
	0...0.25	5 m FEP cable	2	2.4	10...30	21	PS308A
	0...0.6	10 m FEP cable	4	4.8	10...30	21	PS307A
	0...1	15 m FEP cable	5	6	10...30	21	PS317A

Sensors with ATEX approval 3D/3G

Type	Process connection	Display	Measuring range [bar]	P _{overload} max. [bar]	P _{bursting} min. [bar]	U _b DC [V]	Drawing no.	Order no.
------	--------------------	---------	--------------------------	-------------------------------------	-------------------------------------	-----------------------------	-------------	-----------









M12 connector · Output function 1 x normally open / closed programmable + 1 x analogue (I / U, scaleable 1:4) · DC PNP/NPN · Wiring diagram no. 17 · Connector groups 196, 198

	Sealing cone G1 male	Display unit	-1...25	100	350	18...32	22	PI003A
	Sealing cone G1 male	Display unit	-0.0124...0.25	10	30	18...32	22	PI008A
	Sealing cone G1 male	Display unit	-1...1	10	30	18...32	22	PI009A

Full metal sensors for hygienic and wet areas with switching and analogue outputs, IO-Link

Type	Process connection	Display	Measuring range [bar]	P _{overload} max. [bar]	P _{bursting} min. [bar]	U _b DC [V]	Drawing no.	Order no.
------	--------------------	---------	--------------------------	-------------------------------------	-------------------------------------	-----------------------------	-------------	-----------

M12 connector · Output function 1 x normally open / normally closed progr. + 1 x normally open / normally closed progr. or 1 x analogue (4...20 / 20...4 mA, scalable) · Wiring diagram no. 19 · Connector groups 8, 10, 19, 21, 23, 25, 148, 149, 153, 184, 188, 193, 202

	Aseptoflex Vario	Display unit	-1...25	100	350	20...32	23	PI2793
	Aseptoflex Vario	Display unit	-1...10	50	150	20...32	23	PI2794
	Aseptoflex Vario	Display unit	-1...4	30	100	20...32	23	PI2795
	Aseptoflex Vario	Display unit	-0.124...2.5	20	50	20...32	23	PI2796
	Aseptoflex Vario	Display unit	-0.05...1	10	30	20...32	23	PI2797
	Aseptoflex Vario	Display unit	-0.0124...0.25	10	30	20...32	23	PI2798
	Aseptoflex Vario	Display unit	-0.005...0.1	4	30	20...32	23	PI2789
	Aseptoflex Vario	Display unit	-1...1	10	30	20...32	23	PI2799
	Sealing cone G1 male	Display unit	-1...25	100	350	20...32	24	PI2893*



Process sensors

Type	Process connection	Display	Measuring range [bar]	P _{overload} max. [bar]	P _{bursting} min. [bar]	U _b DC [V]	Draw- ing no.	Order no.
------	--------------------	---------	--------------------------	-------------------------------------	-------------------------------------	-----------------------------	---------------------	--------------

M12 connector · Output function 1 x normally open / normally closed progr. + 1 x normally open / normally closed progr. or 1 x analogue (4...20 / 20...4 mA, scalable) · Wiring diagram no. 19 · Connector groups 8, 10, 19, 21, 23, 25, 148, 149, 153, 184, 188, 193, 202

	Sealing cone G1 male	Display unit	-1...10	50	150	20...32	24	PI2894*
	Sealing cone G1 male	Display unit	-1...4	30	100	20...32	24	PI2895*
	Sealing cone G1 male	Display unit	-0.124...2.5	20	50	20...32	24	PI2896*
	Sealing cone G1 male	Display unit	-0.05...1	10	30	20...32	24	PI2897*
	Sealing cone G1 male	Display unit	-0.0124...0.25	10	30	20...32	24	PI2898*
	Sealing cone G1 male	Display unit	-0.005...0.1	4	30	20...32	24	PI2889*
	Sealing cone G1 male	Display unit	-1...1	10	30	20...32	24	PI2899*

* Attention: The unit must only be installed in a process connection for G1 sealing cone! The G1 male sealing cone of the unit is only suited for adapters with metal end stop!

Full-metal high-temperature sensors up to 200 °C for hygienic and wet areas with switching output and analogue output, IO-Link



Type	Process connection	Display	Measuring range [bar]	P _{overload} max. [bar]	P _{bursting} min. [bar]	U _b DC [V]	Draw- ing no.	Order no.
------	--------------------	---------	--------------------------	-------------------------------------	-------------------------------------	-----------------------------	---------------------	--------------

M12 connector · Output function 1 x normally open / normally closed progr. + 1 x normally open / normally closed progr. or 1 x analogue (4...20 / 20...4 mA, scalable) · Wiring diagram no. 20 · Connector groups 8, 10, 19, 21, 23, 25, 148, 149, 153, 184, 188, 193, 202

	Clamp DN 38 / 1½"	Display unit	-1...25	80	150	20...32	25	PI2203
	Clamp DN 38 / 1½"	Display unit	-1...10	50	100	20...32	25	PI2204
	Clamp DN 38 / 1½"	Display unit	-1...4	30	50	20...32	25	PI2205
	Clamp DN 38 / 1½"	Display unit	-0.124...2.5	20	50	20...32	25	PI2206
	Clamp DN 38 / 1½"	Display unit	-0.05...1	10	30	20...32	25	PI2207
	Clamp DN 38 / 1½"	Display unit	-1...1	10	30	20...32	25	PI2209

Type	Process connection	Display	Measuring range [bar]	P _{overload} max. [bar]	P _{bursting} min. [bar]	U _b DC [V]	Draw- ing no.	Order no.
M12 connector · Output function 1 x normally open / normally closed progr. + 1 x normally open / normally closed progr. or 1 x analogue (4...20 / 20...4 mA, scalable) · Wiring diagram no. 20 · Connector groups 8, 10, 19, 21, 23, 25, 148, 149, 153, 184, 188, 193, 202								
	Clamp DN 51 / 2"	Display unit	-1...25	80	150	20...32	26	PI2303
	Clamp DN 51 / 2"	Display unit	-1...10	50	100	20...32	26	PI2304
	Clamp DN 51 / 2"	Display unit	-1...4	30	50	20...32	26	PI2305
	Clamp DN 51 / 2"	Display unit	-0.124...2.5	20	50	20...32	26	PI2306
	Clamp DN 51 / 2"	Display unit	-0.05...1	10	30	20...32	26	PI2307
	Clamp DN 51 / 2"	Display unit	-1...1	10	30	20...32	26	PI2309

Electronic contact manometers for hygienic and wet areas with switching and analogue outputs

Type	Process connection	Display	Measuring range [bar]	P _{overload} max. [bar]	P _{bursting} min. [bar]	U _b DC [V]	Draw- ing no.	Order no.
M12 connector · Output function 1 x normally open / closed programmable + 1 x analogue (4...20 / 20...4 mA, scalable) · DC PNP/NPN · Wiring diagram no. 17 · Connector groups 8, 10, 19, 21, 23, 25, 148, 149, 153, 184, 188, 193, 202								
	Aseptoflex Vario	Display unit	-1...25	100	350	18...32	27	PG2793
	Aseptoflex Vario	Display unit	-1...10	50	150	18...32	27	PG2794
	Aseptoflex Vario	Display unit	-1...4	30	100	18...32	27	PG2795
	Aseptoflex Vario	Display unit	-0.124...2.5	20	50	18...32	27	PG2796
	Aseptoflex Vario	Display unit	-0.05...1	10	30	18...32	27	PG2797
	Aseptoflex Vario	Display unit	-0.0124...0.25	10	30	18...32	27	PG2798
	Aseptoflex Vario	Display unit	-0.005...0.1	4	30	18...32	27	PG2789
	Aseptoflex Vario	Display unit	-1...1	10	30	18...32	27	PG2799



Process sensors



Type	Process connection	Display	Measuring range [bar]	P _{overload} max. [bar]	P _{bursting} min. [bar]	U _b DC [V]	Draw- ing no.	Order no.
M12 connector · Output function 1 x normally open / closed programmable + 1 x analogue (4...20 / 20...4 mA, scalable) · DC PNP/NPN · Wiring diagram no. 17 · Connector groups 8, 10, 19, 21, 23, 25, 148, 149, 153, 184, 188, 193, 202								
	Sealing cone G1 male	Display unit	-1...25	100	350	18...32	28	PG2893*
	Sealing cone G1 male	Display unit	-1...10	50	150	18...32	28	PG2894*
	Sealing cone G1 male	Display unit	-1...4	30	100	18...32	28	PG2895*
	Sealing cone G1 male	Display unit	-0.124...2.5	20	50	18...32	28	PG2896*
	Sealing cone G1 male	Display unit	-0.05...1	10	30	18...32	28	PG2897*
	Sealing cone G1 male	Display unit	-0.0124...0.25	10	30	18...32	28	PG2898*
	Sealing cone G1 male	Display unit	-0.005...0.1	4	30	18...32	28	PG2889*
	Sealing cone G1 male	Display unit	-1...1	10	30	18...32	28	PG2899*

* Attention: The unit must only be installed in a process connection for G1 sealing cone! The G1 male sealing cone of the unit is only suited for adapters with metal end stop!

PF sensors for hygienic and wet areas with switching and analogue outputs

Type	Process connection	Display	Measuring range [bar]	P _{overload} max. [bar]	P _{bursting} min. [bar]	U _b DC [V]	Draw- ing no.	Order no.
M12 connector · Output function 2 x normally open / closed progr. or 1 x normally open / closed progr. + 1 x analogue (4...20 mA / 0...10 V; scaleable 1:4) · Wiring diagram no. 21 · Connector groups 8, 10, 19, 21, 23, 25, 148, 149, 153, 184, 188, 193, 202								
	G ¾ A	Switching status	-1...25	100	200	20...30	29	PF2953
	G ¾ A	Switching status	-0.5...10	50	150	20...30	29	PF2954
	G ¾ A	Switching status	-0.13...2.5	20	50	20...30	29	PF2956
	G ¾ A	Switching status	-0.05...1	10	30	20...30	29	PF2957

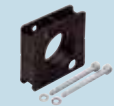
Fixing components for pressure sensors

Type	Description	Order no.
	Angle bracket · Housing materials: PA66-	E30421
	Mounting clamp · Ø 34 mm · Housing materials: PBT	E10017
	Mounting clamp · Ø 34 mm · Housing materials: PA	E10193



Software

Type	Description	Order no.
	LR DEVICE (USB stick) · Parameter setting of the units via the network · Software for clear online and offline parameter setting of IO-Link sensors via USB adapter · Use via USB connection cable (drivers are supplied): E30396 IO-Link interface or E30390 IO-Link master (note the respective data sheet) · IODD import and update from ifm's homepage · Reading of IODDs via storage media · Automatic sensor identification · Graphic representation of the process values and history incl. export function · Documentation and archiving · Transferable parameter sets · Full memory plug support for IO-Link 1.1	QA0011
	LR DEVICE (download) · Parameter setting of the units via the network · Software for clear online and offline parameter setting of IO-Link sensors via USB adapter · Use via USB connection cable (drivers are supplied): E30396 IO-Link interface or E30390 IO-Link master (note the respective data sheet) · IODD import and update from ifm's homepage · Reading of IODDs via storage media · Automatic sensor identification · Graphic representation of the process values and history incl. export function · Documentation and archiving · Transferable parameter sets · Full memory plug support for IO-Link 1.1	QA0012

Certificates

Description	Order no.
Factory calibration certificate for pressure sensors and flow sensors · Measurement points, pressure sensors: 6 measurement points in 20% steps of the final value of the measuring range (acc. to ISO 9001) · Measurement points, flow sensors: 3 or 4 measurement points, distances defined depending on the measuring range (acc. to ISO 9001)	ZC0004
DAkKS calibration certificate for pressure sensors · Number of measuring points: 11-point DAkKS calibration · Measurement points: in 10 % steps of the measuring range (according to directive DAkKS-DKD-R 6-1) · Minimum measurement uncertainty [bar]: 20 µbar...140 mbar (depending on the reference pressure)	ZC0005



Accessories for pressure sensors

Type	Description	Order no.
	Protective cover · for fluid sensors with M12 connector · Housing materials: Polypropylene homopolymer	E30420
	Damping screw · for pressure sensors with M5 internal thread	E30057





Process sensors



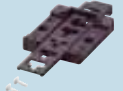

Type	Description	Order no.
	Damping screw · Housing materials: 1.4404	E30419
	Memory plug · Parameter memory for IO-Link sensors · Storage capacity: 2 Kbytes · Housing materials: PA PACM 12 / PET / sealing: FPM / nut: stainless steel 316L / 1.4404 / connector: TPU	E30398
	Teach button · for sensors PP0xE, PP052x, PP755x · for memory plug (E30398) · 0.9 m · Housing materials: stainless steel / PA / PMMA	E30405
	Protective cover · with lead seal option · for pressure sensors type PK · for temperature sensors type TK · for vibration sensors type VK · Housing materials: PP transparent	E30094
	USB IO-Link master · for parameter setting and analysis of units · Supported communication protocols: IO-Link (4.8, 38.4 and 230 Kbits/s) · for operation with FDT framework software "ifm Container" or software "LINERECORDER SENSOR"	E30390
	Syphon · G ¼ · Housing materials: steel	E30140
	Syphon · G ½ · Housing materials: steel	E30141
	Cable clamp fastener · for submersible pressure transmitter PS3 · Housing materials: steel / plastics	E30399
	Filter element · for submersible pressure transmitter PS3 · for fixing on the capillary tube	E30400
	Splitter box · with ventilation and terminal block · for submersible pressure transmitter PS3 · Housing materials: plastics	E30401
	Additional weight · for submersible pressure transmitter PS3 · Housing materials: stainless steel 316Ti / 1.4571	E30402
	DIN rail clip · Housing materials: stainless steel	E37340
	label tag · for fluid sensors · Housing materials: PA	E30422
	Connector · QS-G 1/8-6 · with hexagonal socket 4 mm a/f · for tube with Ø 6 mm · Housing materials: steel / PBT / Brass / aluminium	E30076
	Connector · QS-G 1/8-8 · with hexagonal socket 5 mm a/f · for tube with Ø 8 mm · Housing materials: steel / PBT / Brass / aluminium	E30077

Type	Description	Order no.
	Programming/ display unit · for EPS and IO-Link sensors · Connector · Housing materials: stainless steel 316L / 1.4404 / PC copolymer / PBT / FPM	PP2001
	Accessory cover for filter system · Housing materials: stainless steel	E30142
	Accessory cover for filter system · Housing materials: stainless steel	E30139

Accessories







Type	Description	Order no.
	IO-Link display unit · Connector · Housing materials: stainless steel / PC / PBT-GF 30 / PPS / FKM / PA66 GF30	E30391
	IO-Link display unit · IO-Link inline display for visualising process data of a connected IO-Link sensor; plug & play for ifm devices; internal updatable ifm device catalogue · Connector · Housing materials: stainless steel / PC / PBT-GF 30 / PPS / FKM	E30430
	DIN rail clip · for IO-Link display unit · Housing materials: PA / stainless steel	E30429

Adapters and accessories for adapters





Type	Description	Order no.
	Adapter · R1/8 - R1/8 · rotatable · Housing materials: Brass nickel-plated	E37350
	Flange adapter · G 1/4 · Hole spacing · 31.1 mm · Housing materials: sealing: NBR, acrylonitrile-butadiene-rubber / flange: aluminium / hollow screw: Brass	E30003
	Adapter · G 1/4 - G 1/2 · Housing materials: stainless steel / sealing: FPM	E30000
	Adapter · G 1/4 A - G 1/4 A · Housing materials: 1.4404	E30143
	Adapter · G 1/4 A - R 1/4 · Housing materials: Steel 12L13 / 1.0718 / Process connection sealing: FKM	E30427
	Adapter · G 1/4 - M20 x 1.5 · Housing materials: stainless steel / FPM	E30010















Process sensors

Type	Description	Order no.
	Adapter · G ¼ - G ½ · Housing materials: stainless steel / sealing: FPM	E30050
	Adapter · ¼" NPT - G ¼ · Housing materials: stainless steel 316Ti / 1.4571	E30058
	Adapter · G 1 - G ½ · Housing materials: stainless steel 316L / 1.4404 / sealing: FPM	E30116
	Adapter · G ¼ - G ½ · Housing materials: stainless steel 316Ti / 1.4571 / sealing: FPM	E30135
	O-ring · Ø 24 mm / Ø 28 mm · Housing materials: FKM FDA compliant	E30123
	Sealing ring · Ø 25.9 mm / Ø 29 mm · for Aseptoflex Vario adapter · Housing materials: PEEK FDA compliant	E30124
	Welding mandrel · G 1 · carries away heat during welding · Housing materials: CW614N	E30435

Flange adapters

Type	Description	Order no.
Clamp adapter · 1-1.5" · Aseptoflex Vario		
	Clamp adapter · Clamp · 1-1.5" · ISO 2852 · for units with Aseptoflex Vario adapter · Sealing by sealing ring · Housing materials: stainless steel 316L / 1.4435	E33201
	Clamp adapter · with leakage port · Clamp · 1-1.5" · with sealing ring · ISO 2852 · for units with Aseptoflex Vario adapter · Housing materials: stainless steel 316L / 1.4435	E33208
	Clamp adapter · Clamp · 1-1.5" · ISO 2852 · for units with Aseptoflex Vario adapter · Metal to metal seal · Housing materials: stainless steel 316L / 1.4435	E33701
Clamp adapter · 2" · Aseptoflex Vario		
	Clamp adapter · Clamp · 2" · ISO 2852 · for units with Aseptoflex Vario adapter · Sealing by sealing ring · Housing materials: stainless steel 316L / 1.4435	E33202
	Aseptoflex Vario adapter · with leakage port · Clamp · 2" · with sealing ring · ISO 2852 · for units with Aseptoflex Vario adapter · Housing materials: stainless steel 316L / 1.4435	E33209

Type	Description	Order no.
Clamp adapter · 2" · Aseptoflex Vario		
	Clamp adapter · Clamp · 2" · ISO 2852 · for units with Aseptoflex Vario adapter · Metal to metal seal · Housing materials: stainless steel 316L / 1.4435	E33702
Aseptic clamp connection (clamp DN32) · Aseptoflex Vario		
	Aseptic clamp ferrule with groove · Aseptic clamp connection (clamp DN32) · DIN 11864-NKS-A-35x1.5-1.4435-H4 · for DN32 pipes (according to DIN 11866, type A) · for units with Aseptoflex Vario adapter · Sealing by sealing ring · Housing materials: High-grade stainless steel 316L / 1.4435	E33243
Varivent Adapter · Type F, DN25 (1"), D = 50 · Aseptoflex Vario		
	Clamp adapter · Varivent Adapter · Varivent type F · DN25 (1"), D = 50 · for units with Aseptoflex Vario adapter · Sealing by sealing ring · Housing materials: stainless steel 316L / 1.4435	E33221
	Clamp adapter · Varivent Adapter · with leakage port · Varivent type F · DN25 (1"), D = 50 · for units with Aseptoflex Vario adapter · Sealing by sealing ring · Housing materials: stainless steel 316L / 1.4435	E33228
	Clamp adapter · Varivent Adapter · Varivent type F · DN25 (1"), D = 50 · for units with Aseptoflex Vario adapter · Metal to metal seal · Housing materials: stainless steel 316L / 1.4435	E33721
Varivent Adapter · Type N, DN40...DN150 (1.5...6"), D = 68 · Aseptoflex Vario		
	Clamp adapter · Varivent Adapter · Varivent type N · DN40...DN150 (1.5...6"), D = 68 · for units with Aseptoflex Vario adapter · Sealing by sealing ring · Housing materials: stainless steel 316L / 1.4435	E33222
	Clamp adapter · Varivent Adapter · with leakage port · Varivent type N · DN40 (1.5"), D = 68 · for units with Aseptoflex Vario adapter · Sealing by sealing ring · Housing materials: stainless steel 316L / 1.4435	E33229
	Clamp adapter · Varivent Adapter · Varivent type N · DN40...DN150 (1.5...6"), D = 68 · for units with Aseptoflex Vario adapter · Metal to metal seal · Housing materials: stainless steel 316L / 1.4435	E33722
Hygienic pipe fitting · DN32 (1.25") · Aseptoflex Vario		
	Pipe fitting · Hygienic pipe fitting · Hygienic pipe fitting · DN32 (1.25") · DIN 11851 · for units with Aseptoflex Vario adapter · Sealing by sealing ring · Housing materials: stainless steel 316L / 1.4435	E33211
	Pipe fitting · Hygienic pipe fitting · Hygienic pipe fitting · DN32 (1.25") · DIN 11851 · for units with Aseptoflex Vario adapter · Metal to metal seal · Housing materials: stainless steel 316L / 1.4435	E33711
Hygienic pipe fitting · DN40 (1.5") · Aseptoflex Vario		
	Pipe fitting · Hygienic pipe fitting · Hygienic pipe fitting · DN40 (1.5") · DIN 11851 · for units with Aseptoflex Vario adapter · Sealing by sealing ring · Housing materials: stainless steel 316L / 1.4435	E33212
	Pipe fitting · Hygienic pipe fitting · Hygienic pipe fitting · DN40 (1.5") · DIN 11851 · for units with Aseptoflex Vario adapter · Metal to metal seal · Housing materials: stainless steel 316L / 1.4435	E33712



Process sensors

Type	Description	Order no.
Hygienic pipe fitting · DN50 (2") · Aseptoflex Vario		
	Pipe fitting · Hygienic pipe fitting · Hygienic pipe fitting · DN50 (2") · DIN 11851 · for units with Aseptoflex Vario adapter · Sealing by sealing ring · Housing materials: stainless steel 316L / 1.4435	E33213
	Pipe fitting · Hygienic pipe fitting · Hygienic pipe fitting · DN50 (2") · DIN 11851 · for units with Aseptoflex Vario adapter · Metal to metal seal · Housing materials: stainless steel 316L / 1.4435	E33713
Pipe fitting · DN/OD33.7 · Aseptoflex Vario		
	Pipe fitting · Pipe fitting · DIN 11864-1-A-BS · for ISO pipes (series B) · for units with Aseptoflex Vario adapter · Sealing by sealing ring · Housing materials: stainless steel 316L / 1.4435	E33304
SMS pipe fitting · DN40 (1.5") · Aseptoflex Vario		
	Pipe fitting · SMS pipe fitting · DN40 (1.5") · SMS · for units with Aseptoflex Vario adapter · Metal to metal seal · Housing materials: stainless steel 316L / 1.4435	E33731
SMS pipe fitting · DN50 (2") · Aseptoflex Vario		
	Pipe fitting · SMS pipe fitting · DN50 (2") · SMS · for units with Aseptoflex Vario adapter · Metal to metal seal · Housing materials: stainless steel 316L / 1.4435	E33732
DRD adapter · D65 · Aseptoflex Vario		
	Flange adapter · DRD adapter · flange · DRD · D = 65 · for units with Aseptoflex Vario adapter · Sealing by sealing ring · Housing materials: stainless steel 316L / 1.4435	E33242
universal process adapter · Rd52 · Aseptoflex Vario		
	Pipe fitting · universal process adapter · for units with Aseptoflex Vario adapter · Sealing by sealing ring · Housing materials: stainless steel 316L / 1.4435	E33340
Welding adapter · D50 · Aseptoflex Vario		
	Welding adapter · Ø 50 mm · for units with Aseptoflex Vario adapter · Sealing by sealing ring · Housing materials: stainless steel 316L / 1.4435	E30122
	Welding adapter · Ø 50 mm · with leakage port · for units with Aseptoflex Vario adapter · Sealing by sealing ring · Housing materials: stainless steel 316L / 1.4435	E30130
Aseptoflex Vario · Aseptoflex Vario		
	sealing plug · Aseptoflex Vario · Housing materials: adapter: stainless steel 316L / 1.4435 / sealing ring: FKM	E30128

Type	Description	Order no.
Clamp adapter · 1-1.5" · G 1		
	Clamp adapter · Clamp · 1-1.5" · ISO 2852 · for units with G 1 adaptation · Housing materials: stainless steel 316L / 1.4435	E33601
Clamp adapter · 1-1.5" · G 1		
	Clamp adapter · Clamp · 1-1.5" · ISO 2852 · for units with G 1 adaptation · Housing materials: High-grade stainless steel 316L / 1.4435	E33602
Hygienic pipe fitting · DN40 (1.5") · G 1		
	Pipe fitting · Hygienic pipe fitting · Hygienic pipe fitting · DN40 (1.5") · DIN 11851 · for units with G 1 adaptation · Housing materials: stainless steel 316L / 1.4435	E33612
Welding adapter · D50 · G 1		
	Welding adapter · G 1 - Ø 50 mm · Housing materials: stainless steel 316L / 1.4404	E30013
	Welding adapter · G 1 - Ø 50 mm · Housing materials: stainless steel 316L / 1.4404 / O-ring: FKM / O-ring: EPDM	E30072
G 1		
	sealing plug · G 1 · Housing materials: high-grade stainless steel	E30070
Welding adapter · D50 · G ¾		
	Welding adapter · G ¾ - Ø 50 mm · Housing materials: stainless steel 316L / 1.4404	E30009

Wiring diagrams

Core colours

- BK black
- BN brown
- BU blue
- WH white
- GY grey
- GN green

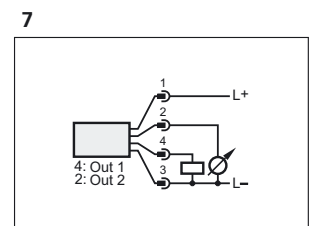
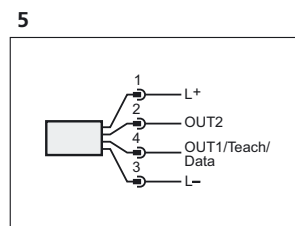
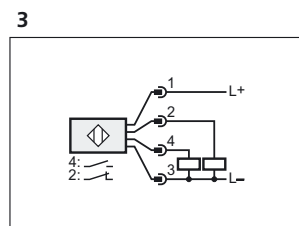
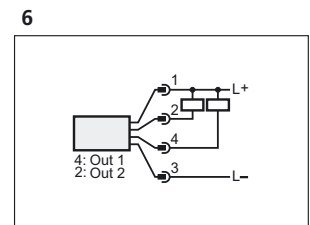
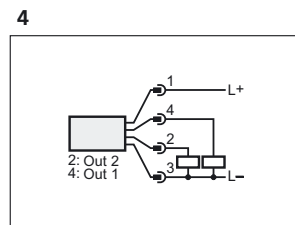
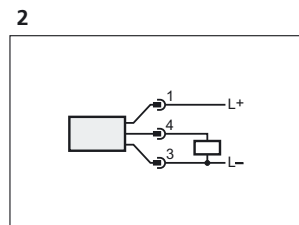
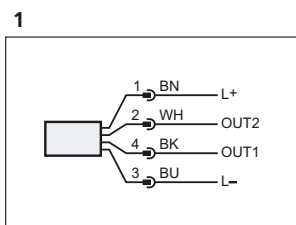



Process sensors

Wiring diagrams

8

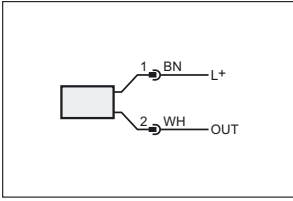

11

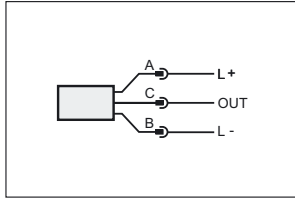

14

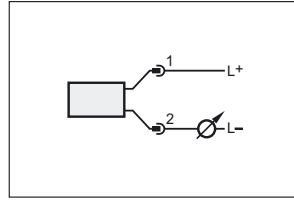

16

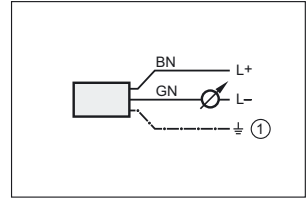

9

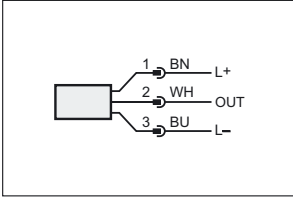

12

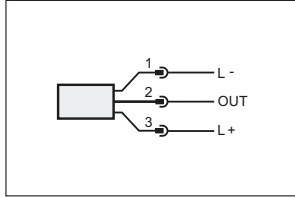

15

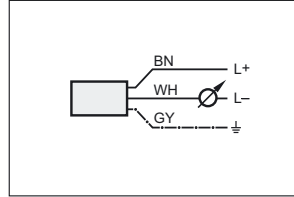

1: screen (connected to the housing)

10

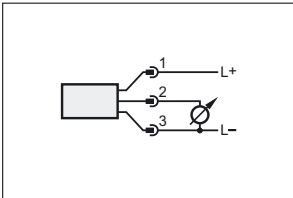

13

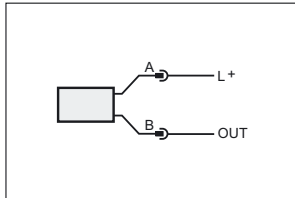

17

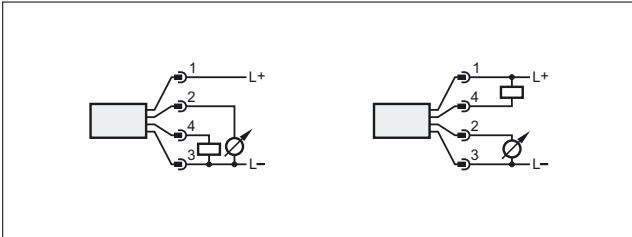

20

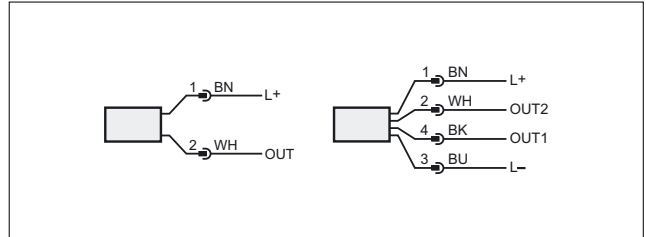

18

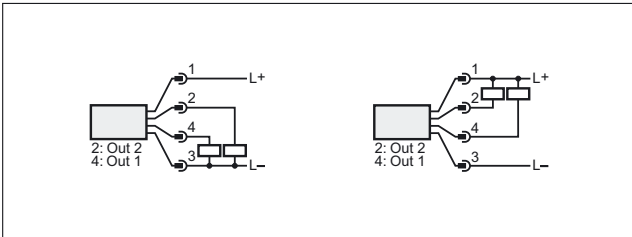

21

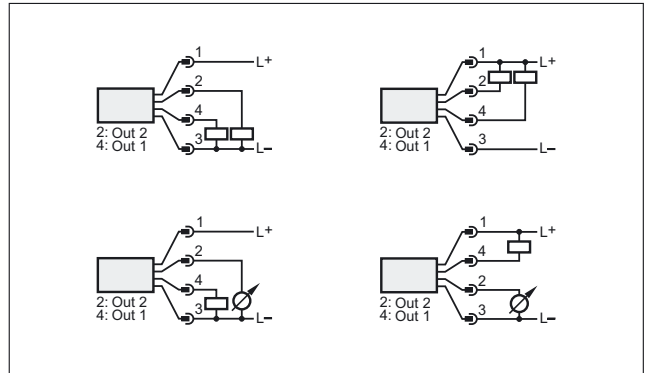

19

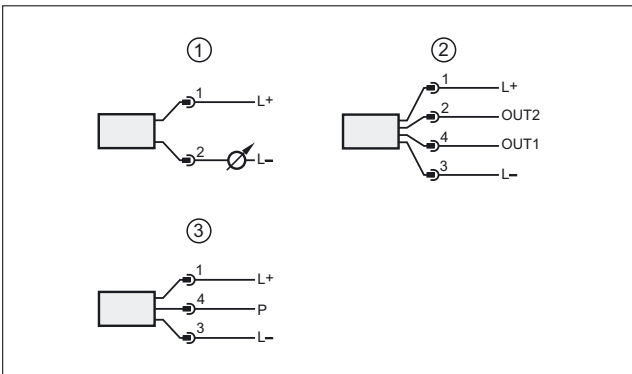

1: connection for 2-wire operation, 2: connection for 3-wire operation, 3: connection for IO-Link parameter setting (P = communication via IO-Link)

Scale drawings / drawing no. – CAD download: www.ifm.com

1

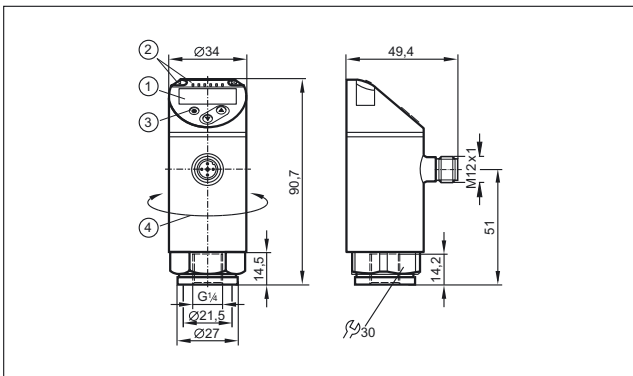

1: 4-digit alphanumeric display / alternating indication of red and green, 2: LEDs (display unit / switching status), 3: Programming button, 4: Upper part of the housing can be rotated by 345°

2

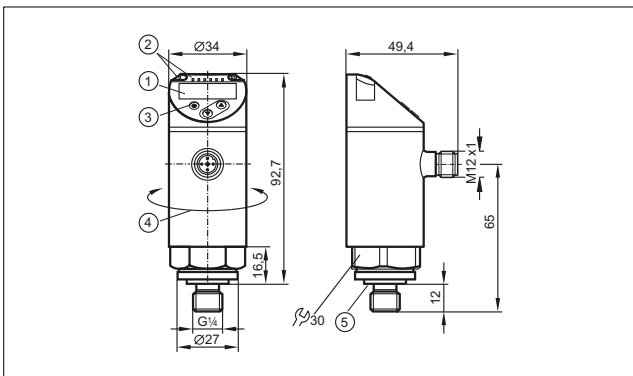

1: 4-digit alphanumeric display / alternating indication of red and green, 2: LEDs (display unit / switching status), 3: Programming button, 4: Upper part of the housing can be rotated by 345°, 5: sealing FKM / DIN 3869

3

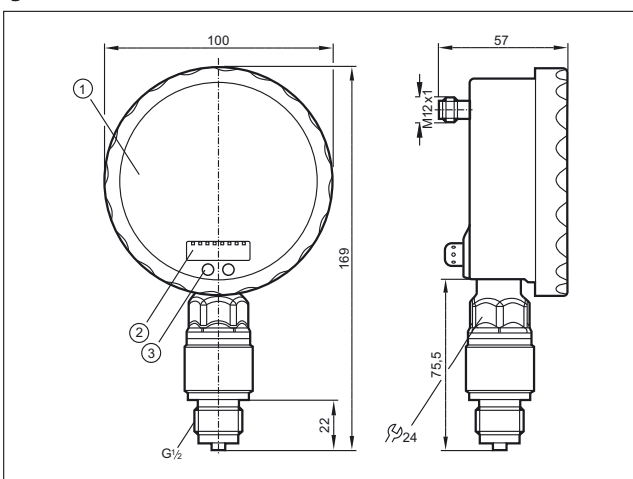

1: Analogue display, 2: 4-digit alphanumeric display, 3: Touch button (programming button)

4

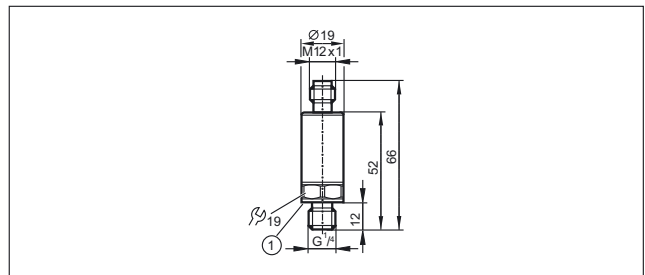

1: sealing

5

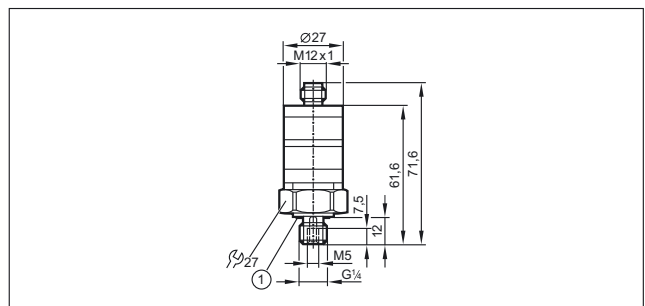

6

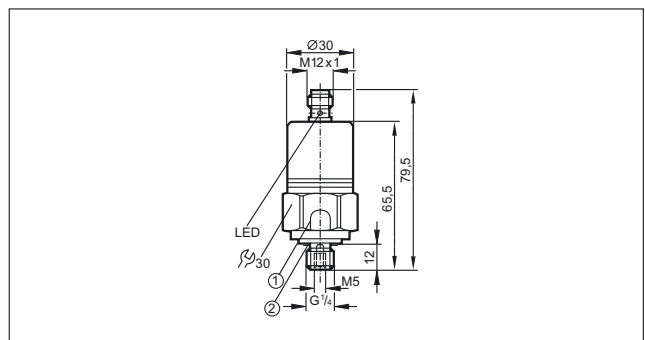

1: Pressure relief mechanism, No mechanical force must be exerted on the pressure relief mechanism., 2: sealing FPM / DIN 3869-14

7

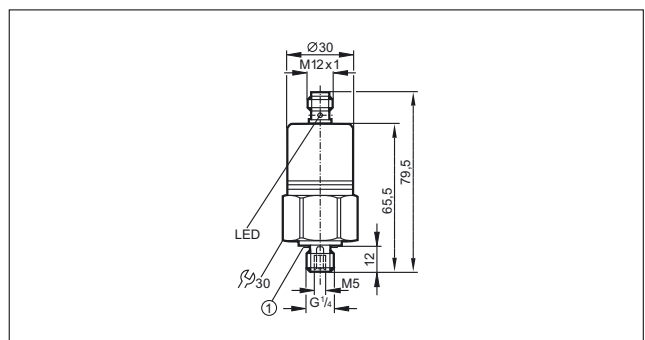

1: sealing FPM / DIN 3869-14



Process sensors

Scale drawings / drawing no. – CAD download: www.ifm.com

8

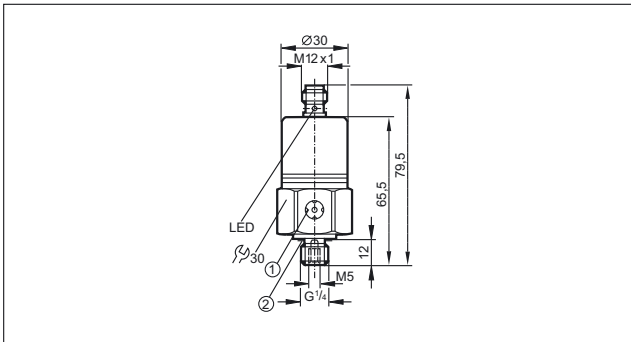

1: ventilation, 2: sealing FPM / DIN 3869-14

9

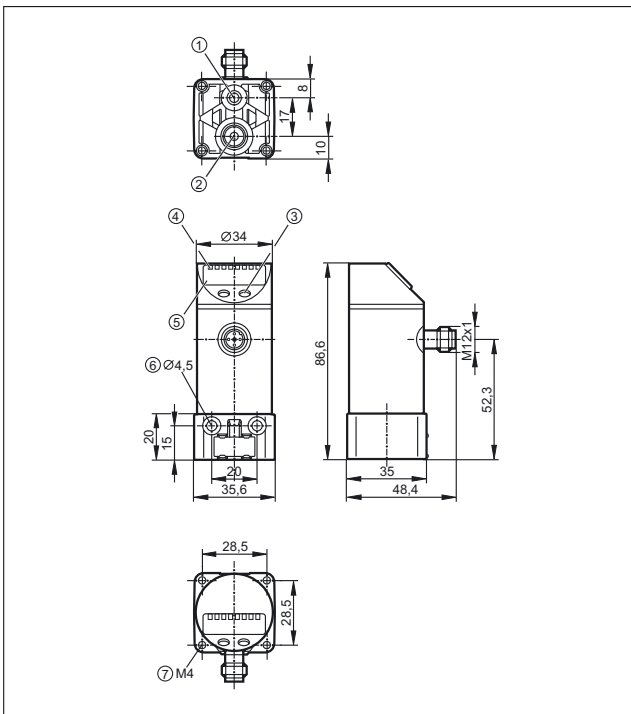

1: ventilation connection M5; max. tightening torque 2.5 Nm, 2: main pressure connection G 1/8; tightening torque max. 8 Nm, 3: Programming button, 4: LEDs (display unit / switching status), 5: 4-digit alphanumeric display, 6: for mounting screw M4; max. tightening torque 2.5 Nm, 7: for mounting screw M4; max. tightening torque 2.5 Nm

10

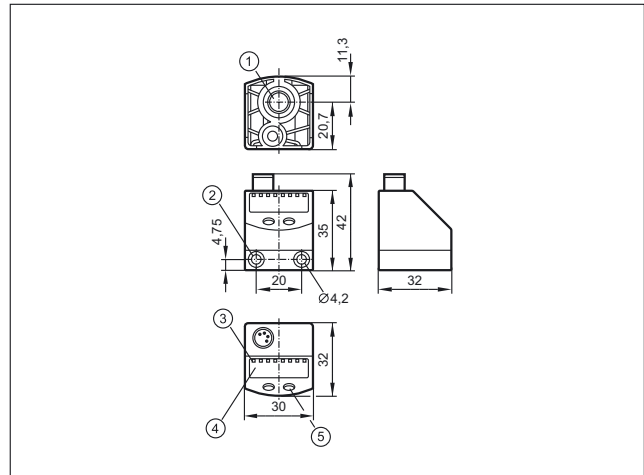

1: main pressure connection G 1/8; tightening torque max. 8 Nm, thread length max: 7.5 mm, 2: for mounting screw M4; max. tightening torque 2.5 Nm, 3: LEDs (display unit / switching status), 4: 4-digit alphanumeric display, 5: Programming button

11

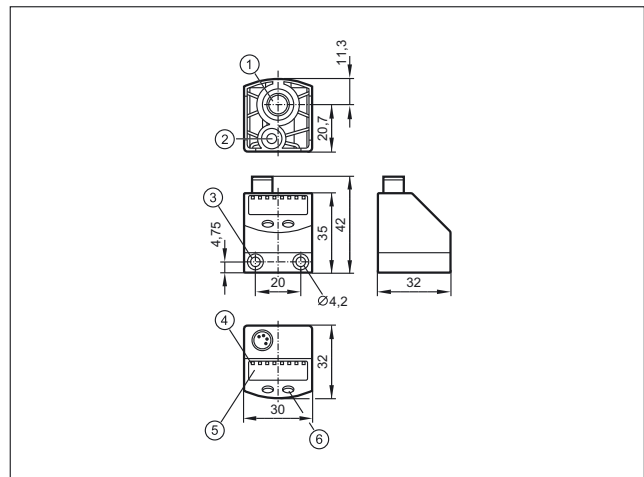

1: Main pressure connection G 1/8; Tightening torque max. 8 Nm, insertion depth max. 7.5 mm, 2: Auxiliary pressure connection M5; Tightening torque max. 2.5 Nm, insertion depth max. 7.5 mm, 3: for mounting screw M4; max. tightening torque 2.5 Nm, 4: LEDs (display unit / switching status), 5: 4-digit alphanumeric display, 6: Programming button

12

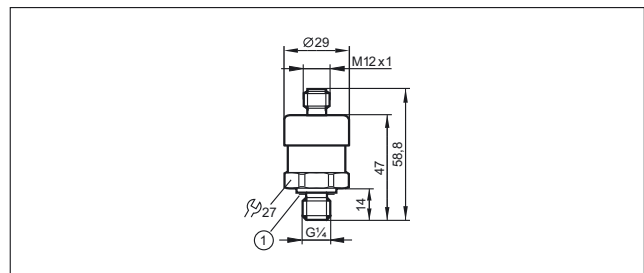

sealing

Scale drawings / drawing no. – CAD download: www.ifm.com

13

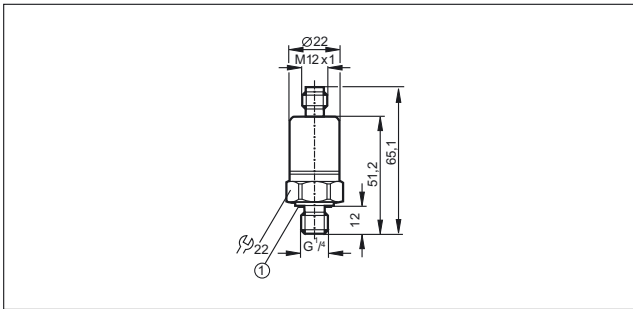

1: FKM seal / DIN 3869-14, tightening torque 25 Nm

14

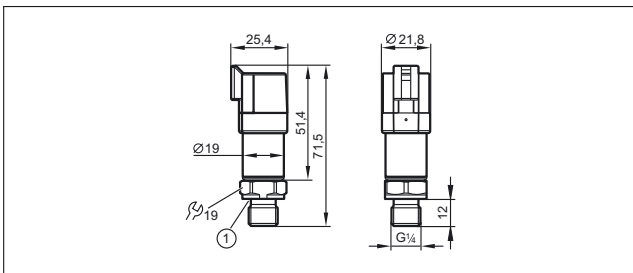

1: sealing FKM / DIN 3869

15

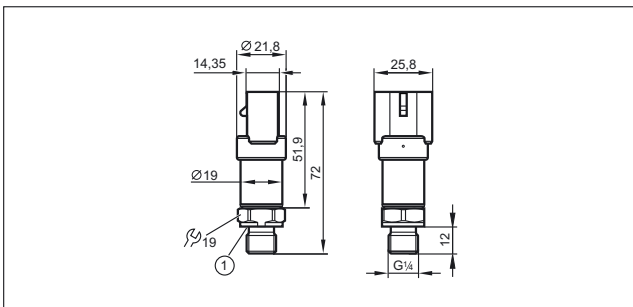

1: sealing FKM / DIN 3869

16

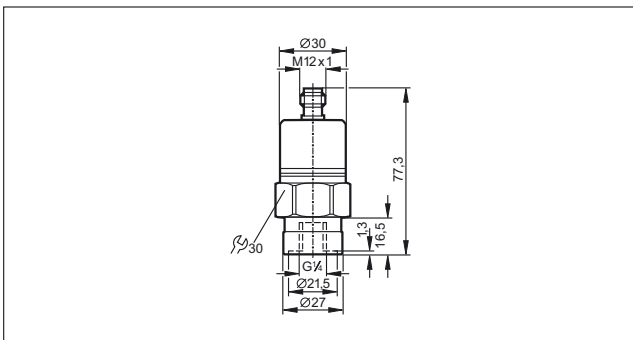

17

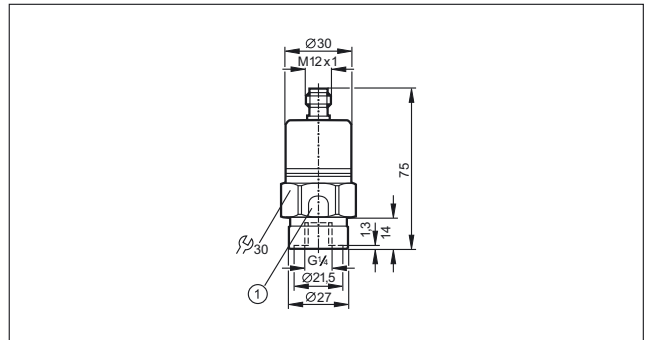

1: Pressure relief mechanism, No mechanical force must be exerted on the pressure relief mechanism.

18

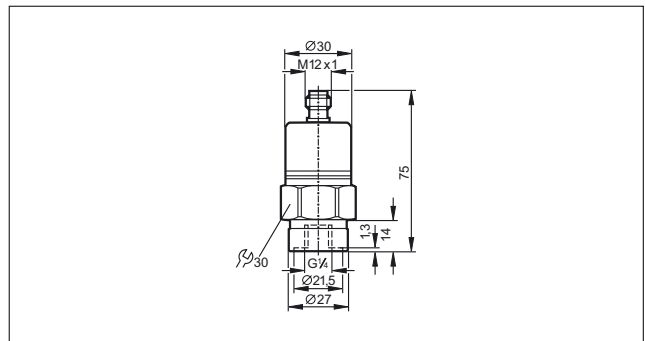

19

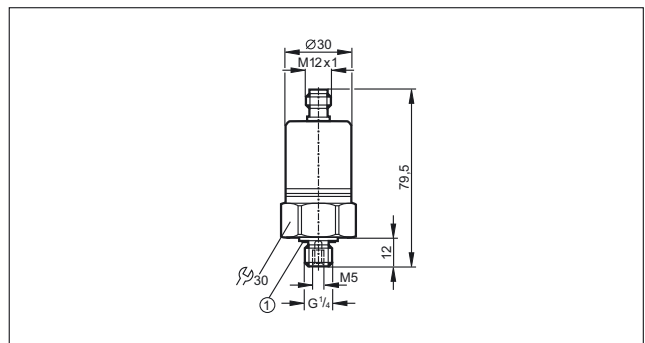

1: sealing FPM / DIN 3869-14

20

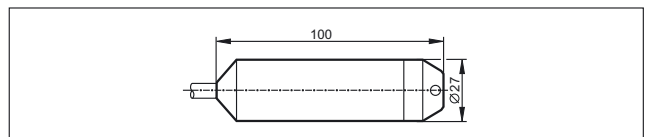

21

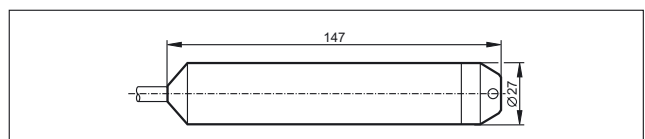



Process sensors

Scale drawings / drawing no. – CAD download: www.ifm.com

22

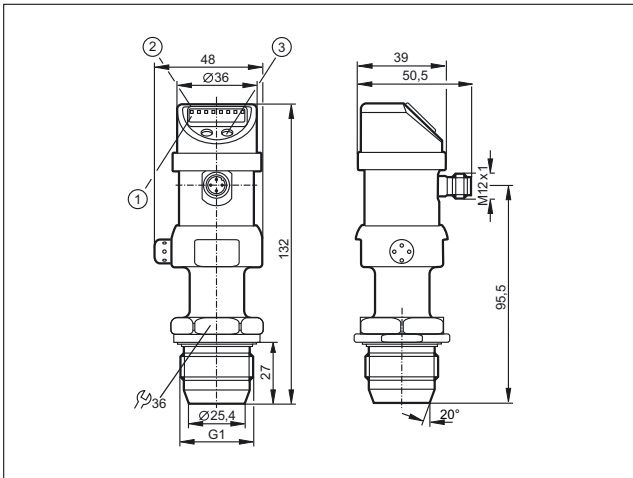

1: 4-digit alphanumeric display, 2: status LEDs, 3: Programming button

25

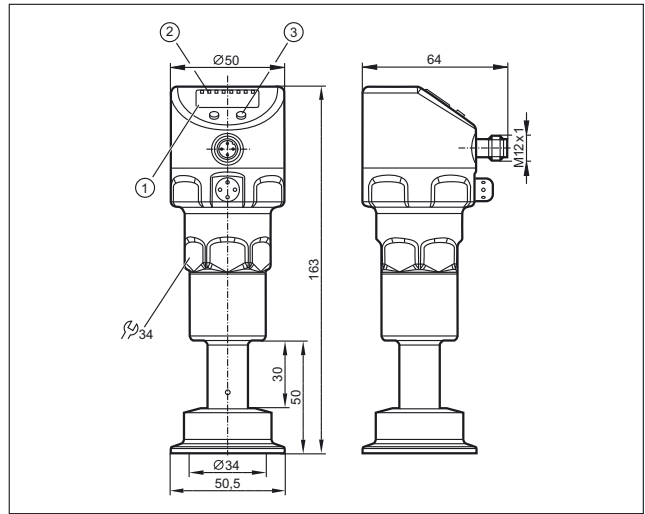

1: 4-digit alphanumeric display, 2: status LEDs, 3: Programming button

23

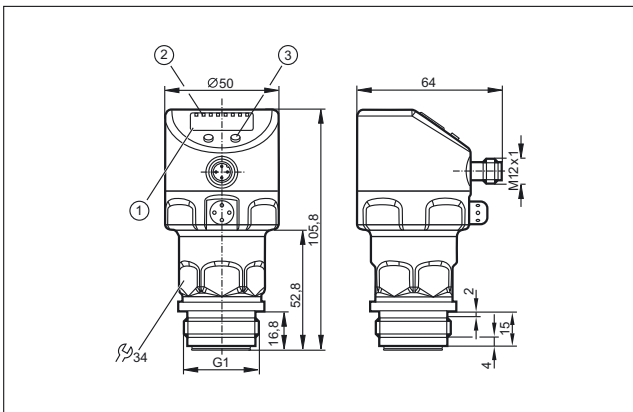

1: 4-digit alphanumeric display, 2: status LEDs, 3: Programming button

26

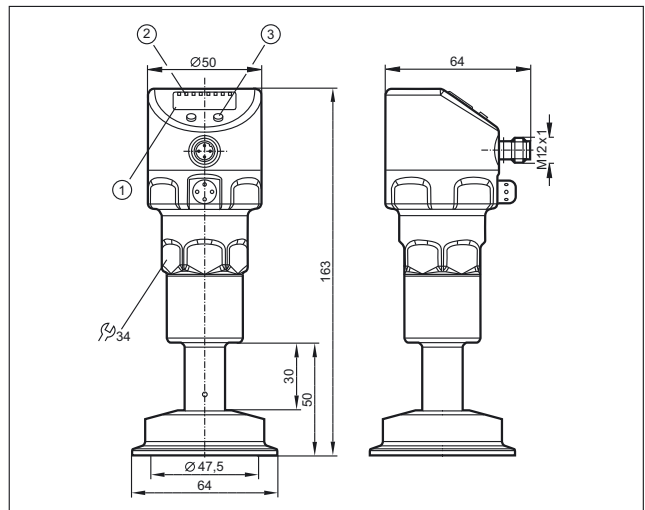

24

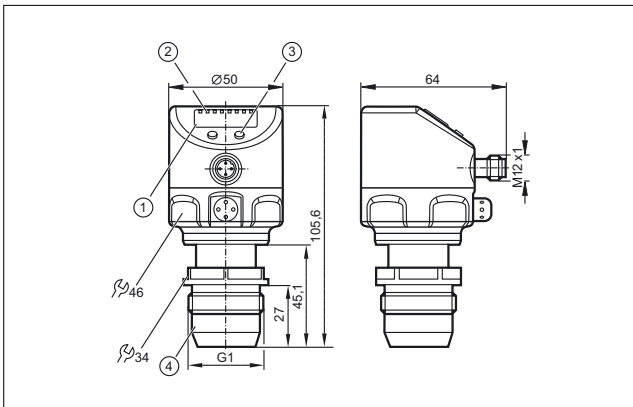

27

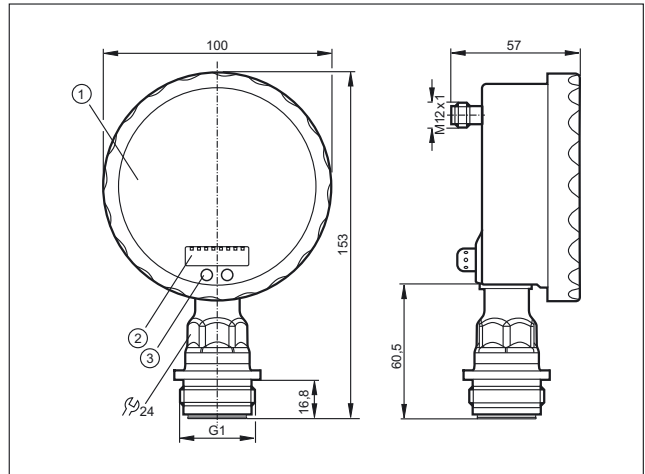

1: Analogue display, 2: 4-digit alphanumeric display, 3: Programming button

Scale drawings / drawing no. – CAD download: www.ifm.com

28

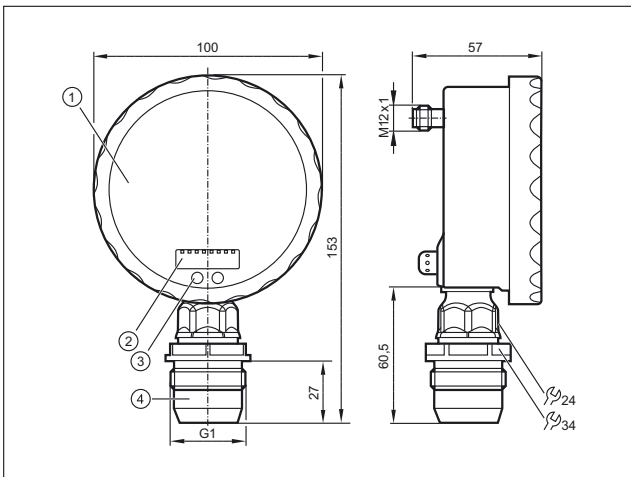

1: Analogue display, 2: 4-digit alphanumeric display, 3: Touch button (programming button), 4: Sealing cone G1 male, Attention: The unit must only be installed in a process connection for G1 sealing cone! The G1 male sealing cone of the unit is only suited for adapters with metal end stop!

29

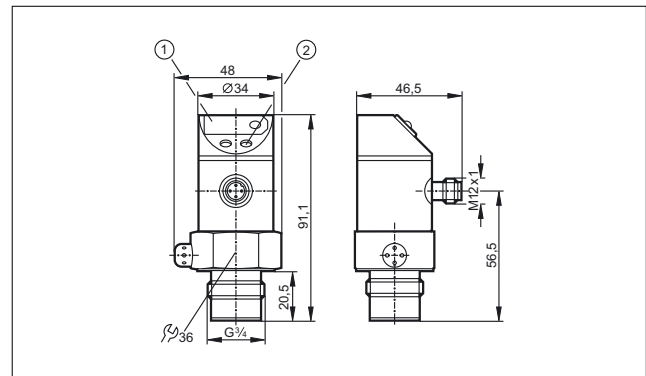

1: 7-segment LED display, 2: Programming button



Process sensors

Flow sensors and flow meters in all versions



Flow sensors / flow meters



For liquids and gases

Special versions for food applications and hazardous areas

Optional fittings for variable process connection

Flow monitoring also for aggressive media

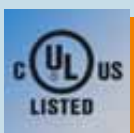
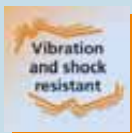

Flow sensors

In almost all fields of process and plant engineering, liquids or gases are used. For coolant and lubricant supply of plant and machinery, ventilation of installations and buildings and product processing. If the flow of these media stops, considerable damage and downtime may result. Therefore it is important to monitor these media. In modern installations, electronic flow monitors are used for this purpose. They work without wear and tear and without mechanical components. This guarantees reliable monitoring even in case of difficult media over a long period.

System overview	Page
Flow meters with integrated temperature measurement	487 - 488
Magnetic-inductive flow meters with integrated temperature measurement (sealing material FKM)	488 - 489
Magnetic-inductive flow meters with integrated temperature measurement (sealing material EPDM)	489 - 490
Magnetic-inductive flow meters (sealing material FKM)	490
Compact housings for adapters for flow monitoring	490 - 491
Compact housings can be configured for T-pieces for flow monitoring	491 - 492
Compact housings for adapters for flow monitoring, Hastelloy sensor tip	492
Compact housings for adapters for flow monitoring, titanium sensor tip	492
Compact designs for adapter with flow and temperature monitoring	492
Compact housings for adapters with ATEX approval group II, category 3D / 3G	493
Compact housings for adapters with Germanischer Lloyd (GL) approval	493
Compact housings for adapters for hygienic and wet areas	493
Mechatronic flow sensors for machine tools	493 - 494
Mechatronic flow sensors with display	494 - 495
Mechatronic flow sensors for liquids	495
Mechatronic flow sensors for high temperatures	496
Flow sensors for connection to control monitors, industrial applications	496 - 497
Flow sensors for connection to control monitors, industrial applications, titanium housing	497
Flow sensors for connection to control monitors for aggressive media, ceramic housing	497
Flow sensors for connection to control monitors with ATEX approval	498
Flow sensors for connection to control monitors with ATEX approval, ceramic housing	498
Flow sensors for connection to control monitors with ATEX approval 2G	499
Air flow monitors	499
Compressed air meters	499 - 500
Compressed air meter for special gases	500
Ultrasonic flow meters for liquids (water, glycol solutions, oils)	500 - 501
Accessories for flow sensors and control monitors	501 - 503
Flange adapters for flow sensors	503 - 505
Accessories for airflow monitors	505
Accessories for flow meters	505 - 507
Grounding clamps for magnetic-inductive flow meters	507
Wiring diagrams	507 - 508



Process sensors

System overview

Page



Scale drawings / drawing no. – CAD download: www.ifm.com

508 - 517



Flow meters with integrated temperature measurement

Type	Process connection	Measuring range [l/min]	Medium temperature [°C]	Pressure rating [bar]	Response time [s]	U _b [V]	Drawing no.	Order no.
------	--------------------	----------------------------	----------------------------	--------------------------	----------------------	-----------------------	-------------	-----------

Output function OUT1: normally open / normally closed programmable or frequency or IO-Link OUT2: normally open / normally closed programmable or frequency · Wiring diagram no. 1 · Connector groups 8, 10, 19, 21, 23, 25, 148, 149, 153, 184, 188, 193, 202

	G ½	1...20	-10...90	12	< 1	18...30	1	SV4200
	Rc ½	1...20	-10...90	12	< 1	18...30	1	SV4500
	G ½	2...40	-10...90	12	< 1	18...30	1	SV5200
	Rc ½	2...40	-10...90	12	< 1	18...30	1	SV5500
	G ¾	5...100	-10...90	12	< 1	18...30	2	SV7200
	Rc ¾	5...100	-10...90	12	< 1	18...30	2	SV7500

Output function OUT1 = analogue signal temperature OUT2 = analogue signal flow · Wiring diagram no. 1 · Connector groups 8, 10, 19, 21, 23, 25, 148, 149, 153, 184, 188, 193, 202





	G ½	1...20	-10...90	12	< 1	18...30	3	SV4204
	Rc ½	1...20	-10...90	12	< 1	18...30	3	SV4504
	G ½	2...40	-10...90	12	< 1	18...30	3	SV5204
	Rc ½	2...40	-10...90	12	< 1	18...30	3	SV5504
	G ¾	5...100	-10...90	12	< 1	18...30	4	SV7204
	Rc ¾	5...100	-10...90	12	< 1	18...30	4	SV7504

Output function analogue · Wiring diagram no. 2 · Connector groups 8, 10, 19, 21, 23, 25, 148, 149, 153, 184, 188, 193, 202



	G ½	0.5...10	-40...100	12	< 0.5	8...33	5	SV3050
	G ½	0.5...10	-40...100	12	< 0.5	8...33	5	SV3150



Process sensors



Type	Process connection	Measuring range [l/min]	Medium temperature [°C]	Pressure rating [bar]	Response time [s]	U _b [V]	Drawing no.	Order no.
Output function analogue · Wiring diagram no. 3 · Connector groups 8, 10, 19, 21, 23, 25, 148, 149, 153, 184, 188, 193, 202								
	G ½	0.9...15	-40...100	12	< 0.5	8...33	6	SV4050
	G ½	0.9...15	-40...100	12	< 0.5	8...33	6	SV4150
	G ¾	1.8...32	-40...100	12	< 0.5	8...33	7	SV5050
	G ¾	1.8...32	-40...100	12	< 0.5	8...33	7	SV5150
	G ¾	3.5...50	-40...100	12	< 0.5	8...33	8	SV6050
	G ¾	3.5...50	-40...100	12	< 0.5	8...33	8	SV6150
	G1	5.0...85	-40...100	12	< 0.5	8...33	9	SV7050
	G1	5.0...85	-40...100	12	< 0.5	8...33	9	SV7150
	G 1¼	9...150	-40...100	12	< 0.5	8...33	10	SV8050
	G 1¼	9...150	-40...100	12	< 0.5	8...33	10	SV8150

Magnetic-inductive flow meters with integrated temperature measurement (sealing material FKM)

Type	Process connection	Measuring range [l/min]	Medium temperature [°C]	Pressure rating [bar]	Response time [s]	U _b [V]	Drawing no.	Order no.
Output function OUT1: normally open / closed programmable or pulse OUT2: normally open / closed programmable or analogue (4...20 mA / 0...10 V, scaleable) · Wiring diagram no. 1 · Connector groups 8, 10, 19, 21, 23, 25, 148, 149, 153, 184, 188, 193, 202								
	G½	0.10...25.00	-10...70	16	< 0.150	18...30	11	SM6000
	G¾	0.2...50.0	-10...70	16	< 0.150	18...30	12	SM7000
	G1	0.2...100.0	-10...70	16	< 0.150	18...30	13	SM8000

Type	Process connection	Measuring range [l/min]	Medium temperature [°C]	Pressure rating [bar]	Response time [s]	U _b [V]	Draw- ing no.	Order no.
------	--------------------	----------------------------	----------------------------	--------------------------	----------------------	-----------------------	------------------	-----------

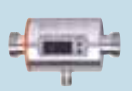
Output function 2 x analogue (4...20 mA scalable) · Wiring diagram no. 1 · Connector groups 8, 10, 19, 21, 23, 25, 148, 149, 153, 184, 188, 193, 202

	G½	0.1...25.00	-10...70	16	< 0.150	20...30	11	SM6004
	G¾	0.2...50.0	-10...70	16	< 0.150	20...30	12	SM7004
	G1	0.2...100.0	-10...70	16	< 0.150	20...30	13	SM8004

Output function OUT1: normally open / normally closed progr. or pulse or frequency or empty pipe detection or IO-Link OUT2: normally open / normally closed progr. or analogue (4...20 mA; 0...10 V, scalable) or empty pipe detection · Wiring diagram no. 1 · Connector groups 8, 10, 12, 13, 19, 21, 22, 23, 24, 25, 148, 149, 150, 152, 153, 154, 155, 184, 186, 188, 190, 192, 193, 194, 202, 205

	G2 flat seal	5...600	-10...70	16	< 0.35	18...32	14	SM2000
	G2 flat seal	5...300	-10...70	16	< 0.35	18...32	14	SM9000

Output function OUT1: analogue (4...20 mA scalable) OUT2: Analogue (4...20 mA scalable) · Wiring diagram no. 1 · Connector groups 8, 10, 19, 21, 23, 25, 148, 149, 153, 184, 188, 193, 202

	G2 flat seal	5...600	-10...70 / 14...158	16	< 0.35	18...32	14	SM2004
	G2 flat seal	5...300	-10...70 / 14...158	16	< 0.35	18...32	14	SM9004

Output function OUT1: normally open / normally closed progr. or pulse or frequency or empty pipe detection or IO-Link OUT2: normally open / normally closed progr. or analogue (4...20 mA; 0...10 V, scalable) or empty pipe detection · Wiring diagram no. 1 · Connector groups 8, 10, 12, 13, 19, 21, 22, 23, 24, 25, 148, 149, 150, 152, 153, 154, 155, 184, 186, 188, 190, 192, 193, 194, 202, 205

	G2 flat seal	5...900	-10...70	16	< 0.35	18...32	14	SM0510
---	--------------	---------	----------	----	--------	---------	----	--------



Magnetic-inductive flow meters with integrated temperature measurement (sealing material EPDM)

Type	Process connection	Measuring range [l/min]	Medium temperature [°C]	Pressure rating [bar]	Response time [s]	U _b [V]	Draw- ing no.	Order no.
------	--------------------	----------------------------	----------------------------	--------------------------	----------------------	-----------------------	------------------	-----------

Output function OUT1: normally open / normally closed progr. or pulse or frequency or empty pipe detection or IO-Link OUT2: normally open / normally closed progr. or analogue (4...20 mA; 0...10 V, scalable) or empty pipe detection · Wiring diagram no. 1 · Connector groups 8, 10, 12, 13, 19, 21, 22, 23, 24, 25, 148, 149, 150, 152, 153, 154, 155, 184, 186, 188, 190, 192, 193, 194, 202, 205

	G2 flat seal	5...600	-10...70	16	< 0.35	18...32	14	SM2100
---	--------------	---------	----------	----	--------	---------	----	--------

Output function OUT1: normally open / closed programmable or pulse OUT2: normally open / closed programmable or analogue (4...20 mA / 0...10 V, scaleable) · Wiring diagram no. 1 · Connector groups 8, 10, 19, 21, 23, 25, 148, 149, 153, 184, 188, 193, 202

	G½	0.10...25.00	-10...70	16	< 0.150	18...30	11	SM6100
	G¾	0.2...50.0	-10...70	16	< 0.150	18...30	12	SM7100



Process sensors

Type	Process connection	Measuring range [l/min]	Medium temperature [°C]	Pressure rating [bar]	Response time [s]	U _b [V]	Draw- ing no.	Order no.
------	--------------------	----------------------------	----------------------------	--------------------------	----------------------	-----------------------	---------------------	--------------

Output function OUT1: normally open / closed programmable or pulse OUT2: normally open / closed programmable or analogue (4...20 mA / 0...10 V, scaleable) · Wiring diagram no. 1 · Connector groups 8, 10, 19, 21, 23, 25, 148, 149, 153, 184, 188, 193, 202

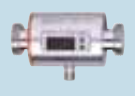

G1	0.2...100.0	-10...70	16	< 0.150	18...30	13	SM8100
----	-------------	----------	----	---------	---------	----	---------------

Output function OUT1: normally open / normally closed progr. or pulse or frequency or empty pipe detection or IO-Link OUT2: normally open / normally closed progr. or analogue (4...20 mA; 0...10 V, scalable) or empty pipe detection · Wiring diagram no. 1 · Connector groups 8, 10, 12, 13, 19, 21, 22, 23, 24, 25, 148, 149, 150, 152, 153, 154, 155, 184, 186, 188, 190, 192, 193, 194, 202, 205



G2 flat seal	5...300	-10...70	16	< 0.35	18...32	14	SM9100
--------------	---------	----------	----	--------	---------	----	---------------

Magnetic-inductive flow meters (sealing material FKM)

Type	Process connection	Measuring range [l/min]	Medium temperature [°C]	Pressure rating [bar]	Response time [s]	U _b [V]	Draw- ing no.	Order no.
------	--------------------	----------------------------	----------------------------	--------------------------	----------------------	-----------------------	---------------------	--------------

M12 connector · Output function 4...20 mA analogue · DC · Wiring diagram no. 4 · Connector groups 8, 10, 19, 21, 23, 25, 148, 149, 153, 184, 188, 193, 202

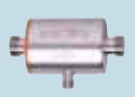

G½	0...25	-10...70	16	< 0.150	18...30	15	SM6050
----	--------	----------	----	---------	---------	----	---------------

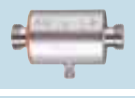

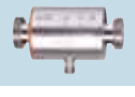

G¾	0...50	-10...70	16	< 0.150	18...30	16	SM7050
----	--------	----------	----	---------	---------	----	---------------



G1	0...100	-10...70	16	< 0.150	18...30	17	SM8050
----	---------	----------	----	---------	---------	----	---------------

Compact housings for adapters for flow monitoring

Type	Setting range liquids / gases [cm/s]	Material sensor tip	Medium temperature [°C]	Pressure rating [bar]	Response time [s]	U _b [V]	Draw- ing no.	Order no.
------	--	------------------------	-------------------------------	-----------------------------	-------------------------	-----------------------	---------------------	--------------

M12 connector · Output function  /  · Wiring diagram no. 5 · Connector groups 8, 10, 19, 21, 23, 25, 148, 149, 153, 184, 188, 193, 202

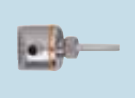

3...300 / 200...3000	stainless steel 316L / 1.4404	-25...80	30	1...10	19...36	18	SI5000
----------------------	-------------------------------	----------	----	--------	---------	----	---------------

M12 connector · Output function 2 x normally open / closed programmable · Wiring diagram no. 6 · Connector groups 8, 10, 19, 21, 23, 25, 148, 149, 153, 184, 188, 193, 202



3...300 / 200...3000	stainless steel 316L / 1.4404	-25...80	300	1...10	18...36	19	SI5002
----------------------	-------------------------------	----------	-----	--------	---------	----	---------------



Type	Setting range liquids / gases [cm/s]	Material sensor tip	Medium temperature [°C]	Pressure rating [bar]	Response time [s]	U _b [V]	Drawing no.	Order no.
------	--------------------------------------	---------------------	-------------------------	-----------------------	-------------------	--------------------	-------------	-----------

1/2" UNF-Connector · Output function  /  · Wiring diagram no. 7 · Connector group 34

	3...300 / 200...3000	stainless steel 316L / 1.4404	-25...80	300	1...10	85...265	20	SI5006*
---	----------------------	-------------------------------	----------	-----	--------	----------	----	---------

M12 connector · Output function 4...20 mA analogue · Wiring diagram no. 8 · Connector groups 8, 10, 19, 21, 23, 25, 148, 149, 153, 184, 188, 193, 202

	3...300 / -	stainless steel 316L / 1.4404	-25...80	300	1...10	19...36	19	SI5004
---	-------------	-------------------------------	----------	-----	--------	---------	----	--------

M12 connector · Output function  /  · Wiring diagram no. 9 · Connector groups 8, 10, 19, 21, 23, 25, 148, 149, 153, 184, 188, 193, 202

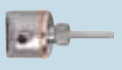
	3...300 / 200...3000	stainless steel 316L / 1.4404	-25...80	300	1...2 / 1...10	18...36	19	SI5010
---	----------------------	-------------------------------	----------	-----	----------------	---------	----	--------

*** Note on use of miniature fuses for electrical connection**

Miniature fuse to IEC60127-2 sheet 1, ≤ 5 A (fast acting) Recommendation: check the unit for reliable function after a short circuit.

Compact housings can be configured for T-pieces for flow monitoring

Type	Process connection	Measuring range [l/min]	Medium temperature [°C]	Pressure rating [bar]	Response time [s]	U _b [V]	Drawing no.	Order no.
------	--------------------	-------------------------	-------------------------	-----------------------	-------------------	--------------------	-------------	-----------

Setting range for relative mode: 0...6 m/s (liquids) and 0...200 m/s (gases) · Connector groups 8, 10, 12, 13, 19, 21, 22, 23, 24, 25, 148, 149, 150, 152, 153, 154, 155, 184, 186, 188, 190, 192, 193, 194, 202, 205

	M18 x 1.5	0.04...3	-20...90	100	0.5	18...30	21	SA5000
---	-----------	----------	----------	-----	-----	---------	----	--------

	M18 x 1.5	0.04...3	-20...90	100	0.5	18...30	21	SA5040
---	-----------	----------	----------	-----	-----	---------	----	--------

	G 1/2	0.04...3	-20...90	100	0.5	18...30	22	SA2000
---	-------	----------	----------	-----	-----	---------	----	--------

	Ø 8 mm	0.04...3	-20...100	50	0.5	18...30	23	SA4100
---	--------	----------	-----------	----	-----	---------	----	--------

	Ø 8 mm	0.04...3	-20...100	50	0.5	18...30	23	SA4300
---	--------	----------	-----------	----	-----	---------	----	--------

Setting range for relative mode: 0...6 m/s (liquids) and 0...200 m/s (gases) · Connector groups 8, 10, 19, 21, 23, 25, 148, 149, 153, 184, 188, 193, 202

	G 1/2	0.04...3	-20...90	100	0.5	18...30	22	SA2004
---	-------	----------	----------	-----	-----	---------	----	--------

	M18 x 1.5	0.04...3	-20...90	100	0.5	18...30	21	SA5004
---	-----------	----------	----------	-----	-----	---------	----	--------



Process sensors

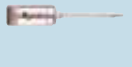
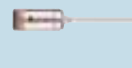

Type	Process connection	Measuring range [l/min]	Medium temperature [°C]	Pressure rating [bar]	Response time [s]	U _b [V]	Draw- ing no.	Order no.
------	--------------------	----------------------------	----------------------------	--------------------------	----------------------	-----------------------	------------------	-----------

Setting range for relative mode: 0...6 m/s (liquids) and 0...200 m/s (gases) · Connector groups 8, 10, 19, 21, 23, 25, 148, 149, 153, 184, 188, 193, 202

	Ø 8 mm	0.04...3	-20...100	100	0.5	18...30	23	SA4104
	Ø 8 mm	0.04...3	-20...100	100	0.5	18...30	23	SA4304

Compact housings for adapters for flow monitoring, Hastelloy sensor tip



Type	Setting range liquids / gases [cm/s]	Material sensor tip	Medium temperature [°C]	Pressure rating [bar]	Response time [s]	U _b [V]	Draw- ing no.	Order no.
------	--	------------------------	-------------------------------	-----------------------------	-------------------------	-----------------------	------------------	-----------

M12 connector · Output function  /  · Wiring diagram no. 9 · Connector groups 8, 10, 19, 21, 23, 25, 148, 149, 153, 184, 188, 193, 202

	3...300 / 200...3000	Hastelloy C-4 (2.4610)	-25...80	300	1...2 / 1...10	19...36	19	SI0553
--	----------------------	------------------------	----------	-----	----------------	---------	----	--------

Compact housings for adapters for flow monitoring, titanium sensor tip

Type	Setting range liquids / gases [cm/s]	Material sensor tip	Medium temperature [°C]	Pressure rating [bar]	Response time [s]	U _b [V]	Draw- ing no.	Order no.
------	--	------------------------	-------------------------------	-----------------------------	-------------------------	-----------------------	------------------	-----------

M12 connector · Output function  /  · Wiring diagram no. 9 · Connector groups 8, 10, 19, 21, 23, 25, 148, 149, 153, 184, 188, 193, 202

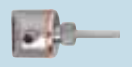
	3...300 / 200...3000	titanium (3.7035)	-25...80	100	1...2 / 1...10	19...36	19	SI5100
---	----------------------	-------------------	----------	-----	----------------	---------	----	--------

Compact designs for adapter with flow and temperature monitoring

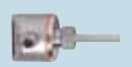

Type	Setting range liquids / gases [cm/s]	Material sensor tip	Medium temperature [°C]	Pressure rating [bar]	Response time [s]	U _b [V]	Draw- ing no.	Order no.
------	--	------------------------	-------------------------------	-----------------------------	-------------------------	-----------------------	------------------	-----------

M12 connector · Output function 2 x normally open / closed programmable · Wiring diagram no. 6 · Connector groups 8, 10, 19, 21, 23, 25, 148, 149, 153, 184, 188, 193, 202

	3...300 / 200...3000	stainless steel 316L / 1.4404	-25...80	300	1...10	18...36	19	SI5007
---	----------------------	-------------------------------	----------	-----	--------	---------	----	--------

Compact housings for adapters with ATEX approval group II, category 3D / 3G

Type	Setting range liquids / gases [cm/s]	Material sensor tip	Medium temperature [°C]	Pressure rating [bar]	Response time [s]	U _b [V]	Drawing no.	Order no.
------	---	---------------------	----------------------------	--------------------------	----------------------	-----------------------	-------------	-----------

M12 connector · Output function  /  · Wiring diagram no. 5 · Connector groups 196, 198

	3...300 / 200...3000	stainless steel 316L / 1.4404	-25...60	30	1...10	19...36	18	SI500A
---	----------------------	-------------------------------	----------	----	--------	---------	----	--------

Compact housings for adapters with Germanischer Lloyd (GL) approval



Type	Setting range liquids / gases [cm/s]	Material sensor tip	Medium temperature [°C]	Pressure rating [bar]	Response time [s]	U _b [V]	Drawing no.	Order no.
------	---	---------------------	----------------------------	--------------------------	----------------------	-----------------------	-------------	-----------



M12 connector · Output function 2 x normally open / closed programmable · Wiring diagram no. 10 · Connector groups 8, 10, 19, 21, 23, 25, 148, 149, 153, 184, 188, 193, 202

	3...300	stainless steel 316L / 1.4404	-15...70	-	1...10	24	19	SI0521
---	---------	-------------------------------	----------	---	--------	----	----	--------

Compact housings for adapters for hygienic and wet areas

Type	Setting range liquids / gases [cm/s]	Material sensor tip	Medium temperature [°C]	Pressure rating [bar]	Response time [s]	U _b [V]	Drawing no.	Order no.
------	---	---------------------	----------------------------	--------------------------	----------------------	-----------------------	-------------	-----------

M12 connector · Output function  /  · Wiring diagram no. 5 · Connector groups 8, 10, 19, 21, 23, 25, 148, 149, 153, 184, 188, 193, 202

	3...300 / 200...3000	stainless steel 316L / 1.4435	-25...95	30	1...10	19...36	24	SI6600
	3...300 / 200...3000	High-grade stainless steel 316L / 1.4435	-25...95	30	1...10	19...36	25	SI6700
	3...300 / 200...3000	High-grade stainless steel 316L / 1.4435	-25...95	30	1...10	19...36	26	SI6800

Mechatronic flow sensors for machine tools

Type	Process connection	Measuring range [l/min]	Medium temperature [°C]	Pressure rating [bar]	Response time [s]	U _b [V]	Drawing no.	Order no.
------	--------------------	----------------------------	----------------------------	--------------------------	----------------------	-----------------------	-------------	-----------

M12 connector · Output function  · DC PNP · Wiring diagram no. 11 · Connector groups 8, 10, 19, 21, 23, 25, 148, 149, 153, 184, 188, 193, 202

	G ½	0.3...25	0...60	200	< 0.01	10...30	27	SBU323
	G ½	0.3...50	0...60	200	< 0.01	10...30	27	SBU324



Process sensors

Type	Process connection	Measuring range [l/min]	Medium temperature [°C]	Pressure rating [bar]	Response time [s]	U _b [V]	Drawing no.	Order no.
------	--------------------	----------------------------	----------------------------	--------------------------	----------------------	-----------------------	-------------	-----------

M12 connector · Output function analogue · DC · Wiring diagram no. 12 · Connector groups 8, 10, 19, 21, 23, 25, 148, 149, 153, 184, 188, 193, 202

	G ½	0.3...25	0...60	200	< 0.01	24	28	SBU623
	G ½	0.3...50	0...60	200	< 0.01	24	28	SBU624
	G ½	0.3...75	0...60	200	< 0.01	24	28	SBU625
	G ½	0.3...75	0...60	200	< 0.01	24	28	SBU625

Mechatronic flow sensors with display

Type	Process connection	Measuring range [l/min]	Medium temperature [°C]	Pressure rating [bar]	Response time [s]	U _b [V]	Drawing no.	Order no.
------	--------------------	----------------------------	----------------------------	--------------------------	----------------------	-----------------------	-------------	-----------

M12 connector · Output function OUT1: NO / NC programmable or frequency or IO-Link OUT2: NO / NC programmable or analogue · DC · Wiring diagram no. 1 · Connector groups 8, 10, 19, 21, 23, 25, 148, 149, 153, 184, 188, 193, 202

	Rp ¾	0.3...15	-10...100	40	0.01	18...30	29	SBY232
	Rp ¾	0.5...25	-10...100	40	0.01	18...30	29	SBY233
	Rp ¾	1...50	-10...100	40	0.01	18...30	29	SBY234
	Rp 1	2...100	-10...100	25	0.01	18...30	30	SBY246
	Rp 1½	4...200	-10...100	25	0.01	18...30	31	SBY257
	G ½	0.3...15	-10...100	40	0.01	18...30	32	SBG232
	G ½	0.5...25	-10...100	40	0.01	18...30	32	SBG233
	G ½	1...50	-10...100	40	0.01	18...30	32	SBG234
	G ¾	2...100	-10...100	25	0.01	18...30	33	SBG246

Type	Process connection	Measuring range [l/min]	Medium temperature [°C]	Pressure rating [bar]	Response time [s]	U _b [V]	Drawing no.	Order no.
------	--------------------	----------------------------	----------------------------	--------------------------	----------------------	-----------------------	-------------	-----------

M12 connector · Output function OUT1: NO / NC programmable or frequency or IO-Link OUT2: NO / NC programmable or analogue · DC · Wiring diagram no. 1 · Connector groups 8, 10, 19, 21, 23, 25, 148, 149, 153, 184, 188, 193, 202



	G 1/4	4...200	-10...100	25	0.01	18...30	34	SBG257
--	-------	---------	-----------	----	------	---------	----	--------

Mechatronic flow sensors for liquids

Type	Process connection	Measuring range [l/min]	Medium temperature [°C]	Pressure rating [bar]	Response time [s]	U _b [V]	Drawing no.	Order no.
------	--------------------	----------------------------	----------------------------	--------------------------	----------------------	-----------------------	-------------	-----------

M12 connector · Output function \overline{L} · DC PNP · Wiring diagram no. 11 · Connector groups 8, 10, 19, 21, 23, 25, 148, 149, 153, 184, 188, 193, 202



	Rp 1/2	0.2...4	0...85	80	< 0.01	10...30	35	SBY321
--	--------	---------	--------	----	--------	---------	----	--------



	Rp 3/4	1...15	0...85	40	< 0.01	10...30	36	SBY332
--	--------	--------	--------	----	--------	---------	----	--------



	Rp 1/2	2...20	0...85	25	< 0.01	10...30	37	SBY323
--	--------	--------	--------	----	--------	---------	----	--------



	Rp 3/4	1...25	0...85	40	< 0.01	10...30	36	SBY333
--	--------	--------	--------	----	--------	---------	----	--------



	Rp 3/4	2...50	0...85	40	< 0.01	10...30	36	SBY334
--	--------	--------	--------	----	--------	---------	----	--------



	Rp 1	5...100	0...85	25	< 0.01	10...30	38	SBY346
--	------	---------	--------	----	--------	---------	----	--------



	Rp 1 1/2	20...200	0...85	25	< 0.01	10...30	39	SBY357
--	----------	----------	--------	----	--------	---------	----	--------



	G 1/2	1...15	0...85	40	< 0.01	10...30	40	SBG332
--	-------	--------	--------	----	--------	---------	----	--------



	G 1/2	1...25	0...85	40	< 0.01	10...30	40	SBG333
--	-------	--------	--------	----	--------	---------	----	--------



	G 1/2	2...50	0...85	40	< 0.01	10...30	40	SBG334
--	-------	--------	--------	----	--------	---------	----	--------



	G 3/4	5...100	0...85	25	< 0.01	10...30	41	SBG346
--	-------	---------	--------	----	--------	---------	----	--------



	G 1 1/4	20...200	0...85	25	< 0.01	10...30	42	SBG357
--	---------	----------	--------	----	--------	---------	----	--------



Process sensors

Mechatronic flow sensors for high temperatures

Type	Process connection	Measuring range [l/min]	Medium temperature [°C]	Pressure rating [bar]	Response time [s]	U _b [V]	Drawing no.	Order no.
------	--------------------	----------------------------	----------------------------	--------------------------	----------------------	-----------------------	-------------	-----------

M12 connector · Output function analogue · DC · Wiring diagram no. 12 · Connector groups 8, 10, 19, 21, 23, 25, 148, 149, 153, 184, 188, 193, 202

	Rp 3/4	1...25	-10...100	40	< 0.01	18...32	43	SBY433
	Rp 3/4	2...50	-10...100	40	< 0.01	18...32	43	SBY434
	Rp 1	4...100	-10...100	25	< 0.01	18...32	44	SBY446
	Rp 1 1/2	8...200	-10...100	25	< 0.01	18...32	45	SBY457

Cable with connector 0.3 m · Output function analogue · DC · Wiring diagram no. 12 · Connector groups 8, 10, 19, 21, 23, 25, 148, 149, 153, 184, 188, 193, 202

	Rp 3/4	0.3...25	10...180	15	< 0.01	24	46	SBT633
	Rp 3/4	0.3...50	10...180	15	< 0.01	24	46	SBT634

Flow sensors for connection to control monitors, industrial applications

Type	Setting range liquids / gases [cm/s]	Greatest sensitivity [cm/s]	Medium temperature [°C]	Response time [s]	Max. T ₀ gradient [K/min]	Pressure rating [bar]	Drawing no.	Order no.
------	---	--------------------------------	----------------------------	----------------------	---	--------------------------	-------------	-----------

M12 connector · Wiring diagram no. 13 · Connector groups 12, 13, 22, 24, 152, 155, 186, 192, 194, 205

	3...300 / 200...3000	3...60 / 200...800	-25...80	1...10	30	30	47	SF6200
	3...300 / 200...3000	3...60 / 200...800	-25...80	1...10	30	30	48	SF6201

M12 connector · Wiring diagram no. 13 · Connector groups 152, 155, 186, 192, 194, 205

	3...300 / 200...3000	3...60 / 200...800	-25...80	1...10	300	300	49	SF5200
	3...300 / 200...3000	3...60 / 200...800	-25...80	1...10	300	30	50	SF5201

Cable 6 m · Wiring diagram no. 14

	3...300 / 200...3000	3...60 / 200...800	-25...80	1...10	300	300	51	SF5350
--	----------------------	--------------------	----------	--------	-----	-----	----	---------------

Type	Setting range liquids / gases [cm/s]	Greatest sensitivity [cm/s]	Medium temperature [°C]	Response time [s]	Max. T ₀ gradient [K/min]	Pressure rating [bar]	Drawing no.	Order no.
------	---	--------------------------------	----------------------------	----------------------	---	--------------------------	-------------	-----------

Cable 6 m · Wiring diagram no. 14

	3...300 / 200...3000	3...60 / 200...800	0...120 / 0...100	1...10	300	300	51	SF5300
---	----------------------	--------------------	-------------------	--------	-----	-----	----	--------

Flow sensors for connection to control monitors, industrial applications, titanium housing

Type	Setting range liquids / gases [cm/s]	Greatest sensitivity [cm/s]	Medium temperature [°C]	Response time [s]	Max. T ₀ gradient [K/min]	Pressure rating [bar]	Drawing no.	Order no.
------	---	--------------------------------	----------------------------	----------------------	---	--------------------------	-------------	-----------

Cable 6 m · Wiring diagram no. 14

	3...300 / 200...3000	3...60 / 200...800	0...120 / 0...100	1...10	300	100	51	SF5800
---	----------------------	--------------------	-------------------	--------	-----	-----	----	--------

M12 connector · Wiring diagram no. 13 · Connector groups 152, 155, 186, 192, 194, 205

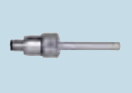
	3...300 / 200...3000	3...60 / 200...800	-25...80	1...10	300	100	49	SF5700
--	----------------------	--------------------	----------	--------	-----	-----	----	--------

Flow sensors for connection to control monitors for aggressive media, ceramic housing

Type	Setting range liquids / gases [cm/s]	Greatest sensitivity [cm/s]	Medium temperature [°C]	Response time [s]	Max. T ₀ gradient [K/min]	Pressure rating [bar]	Drawing no.	Order no.
------	---	--------------------------------	----------------------------	----------------------	---	--------------------------	-------------	-----------

M12 connector · Wiring diagram no. 13 · Connector groups 12, 13, 22, 24, 152, 155, 186, 192, 194, 205

	3...60 / -	3...40 / -	5...70	2...20	7	30	52	SF2405
---	------------	------------	--------	--------	---	----	----	--------

	3...60 / -	3...40 / -	5...70	2...20	7	30	53	SF3405
---	------------	------------	--------	--------	---	----	----	--------

Cable 6 m · Wiring diagram no. 14







	3...60 / -	3...40 / -	5...70	2...20	7	30	54	SF2410
---	------------	------------	--------	--------	---	----	----	--------

	3...60 / -	3...40 / -	5...70	2...20	7	30	55	SF3410
---	------------	------------	--------	--------	---	----	----	--------





Process sensors

Flow sensors for connection to control monitors with ATEX approval

Type	Setting range liquids / gases [cm/s]	Greatest sensitivity [cm/s]	Medium temperature [°C]	Response time [s]	Max. T ₀ gradient [K/min]	Pressure rating [bar]	Drawing no.	Order no.
Cable 6 m · Wiring diagram no. 15								
	3...300 / 200...2000	3...60 / 200...800	-20...60	1...10	15	300	56	SF111A
	3...300 / 200...2000	3...60 / 200...800	-20...60	1...10	15	300	57	SF211A
	3...300 / 200...2000	3...60 / 200...800	-20...60	1...10	15	300	58	SF311A
	3...300 / 200...2000	3...60 / 200...800	-20...70	1...10	15	30	59	SF121A
	3...300 / 200...2000	3...60 / 200...800	-20...70	1...10	15	30	60	SF221A
	3...300 / 200...2000	3...60 / 200...800	-20...70	1...10	15	30	61	SF321A

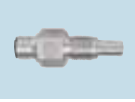
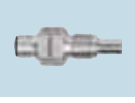
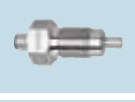
M12 connector · Wiring diagram no. 16 · Connector group 197

	3...300 / 200...2000	3...60 / 200...800	-20...70	1...10	15	30	62	SF120A
	3...300 / 200...2000	3...60 / 200...800	-20...70	1...10	15	30	63	SF220A
	3...300 / 200...2000	3...60 / 200...800	-20...70	1...10	15	30	64	SF320A
	3...300 / 200...3000	3...60 / 200...800	-20...70	1...10	15	30	47	SF620A

Flow sensors for connection to control monitors with ATEX approval, ceramic housing

Type	Setting range liquids / gases [cm/s]	Greatest sensitivity [cm/s]	Medium temperature [°C]	Response time [s]	Max. T ₀ gradient [K/min]	Pressure rating [bar]	Drawing no.	Order no.
Cable 6 m · Wiring diagram no. 15								
	3...60 / -	3...40 / -	5...70	2...20	7	30	55	SF323A

Flow sensors for connection to control monitors with ATEX approval 2G

Type	Setting range liquids / gases [cm/s]	Greatest sensitivity [cm/s]	Medium temperature [°C]	Response time [s]	Max. T ₀ gradient [K/min]	Pressure rating [bar]	Drawing no.	Order no.
------	---	--------------------------------	----------------------------	----------------------	---	--------------------------	-------------	-----------

Cable 6 m · Wiring diagram no. 17

	3...300 / 100...15000	3...100 / 100...7500	-20...70	1...10	30	30	65	SP321A
---	-----------------------	----------------------	----------	--------	----	----	----	--------

Air flow monitors

Type	Setting range liquids / gases [cm/s]	Greatest sensitivity [cm/s]	Medium temperature [°C]	Response time [s]	U _b / tolerance [V] / [%]	Drawing no.	Order no.
------	---	--------------------------------	----------------------------	----------------------	---	-------------	-----------

Cable 2 m · Wiring diagram no. 18

	100...1000	100...400	-10...50	3...60	80...250 AC	66	SL0101*
---	------------	-----------	----------	--------	-------------	----	---------

Cable 2 m · Wiring diagram no. 19

	100...1000	100...400	-10...50	3...60	24 AC ± 10 %	66	SL0201*
---	------------	-----------	----------	--------	--------------	----	---------

Cable 2 m · Wiring diagram no. 20

	100...1000	100...400	-10...50	3...60	24 DC ± 25 %	66	SL5101
---	------------	-----------	----------	--------	--------------	----	--------



*** Note on use of miniature fuses for electrical connection**

Miniature fuse to IEC60127-2 sheet 1, ≤ 5 A (fast acting) Recommendation: check the unit for reliable function after a short circuit.

Compressed air meters

Type	Process connection	Setting range [Nm ³ /h]	Pressure rating [bar]	Response time [s]	U _b [V]	Drawing no.	Order no.
------	--------------------	---------------------------------------	--------------------------	----------------------	-----------------------	-------------	-----------

Output function OUT1: normally open / closed programmable or pulse OUT2: normally open / closed programmable or analogue (4...20 mA scaleable) · Wiring diagram no. 21 · Connector groups 8, 10, 19, 21, 23, 25, 148, 149, 153, 184, 188, 193, 202



	G ¼ (DN8)	0.12...15.00	16	< 0.1	18...30	67	SD5000
	R½ (DN15)	0.6...75.0	16	< 0.1	18...30	68	SD6000
	G ½ (DN15)	0.6...75	16	< 0.1	18...30	69	SD6050



Process sensors

Type	Process connection	Setting range [Nm ³ /h]	Pressure rating [bar]	Response time [s]	U _b [V]	Draw- ing no.	Order no.
------	--------------------	---------------------------------------	--------------------------	----------------------	-----------------------	---------------------	--------------

Output function OUT1: normally open / closed programmable or pulse OUT2: normally open / closed programmable or analogue (4...20 mA scaleable) · Wiring diagram no. 21 · Connector groups 8, 10, 19, 21, 23, 25, 148, 149, 153, 184, 188, 193, 202

	R1 (DN25)	1.8...225.0	16	< 0.1	18...30	70	SD8000
	R1½ (DN40)	3.5...410.0	16	< 0.1	18...30	71	SD9000
	R2 (DN50)	5...700	16	< 0.1	18...30	72	SD2000

Output function OUT1: normally open / closed programmable or pulse OUT2: normally open / closed programmable or analogue (4...20 mA scaleable) · Wiring diagram no. 1 · Connector groups 8, 10, 19, 21, 23, 25, 148, 149, 153, 184, 188, 193, 202

	G 1 I	18...2110	16	< 0.1	18...30	73	SD0523
---	-------	-----------	----	-------	---------	----	--------

Compressed air meter for special gases

Type	Process connection	Setting range [Nm ³ /h]	Medium temperature [°C]	Pressure rating [bar]	Response time [s]	U _b [V]	Draw- ing no.	Order no.
------	--------------------	---------------------------------------	----------------------------	--------------------------	----------------------	-----------------------	---------------------	--------------

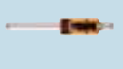

Output function OUT1: normally open / closed programmable or pulse OUT2: normally open / closed programmable or analogue (4...20 mA scaleable) · Wiring diagram no. 24 · Connector groups 8, 10, 19, 21, 23, 25, 148, 149, 153, 184, 188, 193, 202

	G ¼ (DN8)	N ₂ : 0.04...15.00 Ar: 0.08...24.04 CO ₂ : 0.04...14.36	0...60	16	< 0.1	18...30	67	SD5100
	R½ (DN15)	N ₂ : 0.2...75.0 Ar: 0.4...122.0 CO ₂ : 0.2...74.7	0...60	16	< 0.1	18...30	68	SD6100

Ultrasonic flow meters for liquids (water, glycol solutions, oils)



Type	Process connection	Measuring range [l/min]	Medium temperature [°C]	Pressure rating [bar]	Response time [s]	U _b [V]	Draw- ing no.	Order no.
------	--------------------	----------------------------	----------------------------	--------------------------	----------------------	-----------------------	---------------------	--------------

Output function 2 x normally open / closed programmable · Wiring diagram no. 6 · Connector groups 8, 10, 19, 21, 23, 25, 148, 149, 153, 184, 188, 193, 202







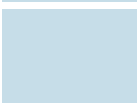

	G¾	0.1...50.0	-10...80	16	< 0.250	19...30	74	SU7200
	G1	0.2...100.0	-10...80	16	< 0.250	19...30	75	SU8200

Output function OUT1: normally open / closed programmable or pulse OUT2: normally open / closed programmable or analogue (4...20 mA / 0...10 V, scaleable) · Wiring diagram no. 22 · Connector groups 8, 10, 19, 21, 23, 25, 148, 149, 153, 184, 188, 193, 202

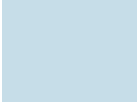
	G¾	0.1...50.0	-10...80	16	< 0.250	19...30	74	SU7000
---	----	------------	----------	----	---------	---------	----	--------

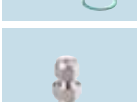

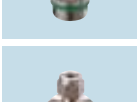











Type	Process connection	Measuring range [l/min]	Medium temperature [°C]	Pressure rating [bar]	Response time [s]	U _b [V]	Draw- ing no.	Order no.
Output function OUT1: normally open / closed programmable or pulse OUT2: normally open / closed programmable or analogue (4...20 mA / 0...10 V, scaleable) · Wiring diagram no. 22 · Connector groups 8, 10, 19, 21, 23, 25, 148, 149, 153, 184, 188, 193, 202								
	G1	0.2...100.0	-10...80	16	< 0.250	19...30	75	SU8000
	G1¼	0.4...200.0	-10...80	16	< 0.250	19...30	76	SU9000
Output function 2 x analogue (4...20 mA scalable) · Wiring diagram no. 23 · Connector groups 8, 10, 19, 21, 23, 25, 148, 149, 153, 184, 188, 193, 202								
	G1¼	0.0...200.0	-10...80	16	< 0.250	19...30	76	SU9004











Accessories for flow sensors and control monitors

Type	Description	Order no.
	T-piece · R½ · M26 x 1.5 - R½ · for sensors and adapters with process connection M26 x 1.5 · Flow rate: 0...10 l/min · Housing materials: stainless steel 316L / 1.4404	E40136
	Progressive ring T-piece DIN 2353 · QL 18-18-18 · for sensors and adapters with process connection M26 x 1.5 · Recommendation: precision steel pipes 18 x 1.5 to DIN 2391/ISO 3304 · Housing materials: stainless steel 316Ti / 1.4571	E40078
	Progressive ring T-piece DIN 2353 · QL 22-18-22 · for sensors and adapters with process connection M26 x 1.5 · Recommendation: precision steel pipes 22 x 1.5 to DIN 2391/ISO 3304 · Housing materials: stainless steel 316Ti / 1.4571	E40079
	Progressive ring T-piece DIN 2353 · QL 28-18-28 · for sensors and adapters with process connection M26 x 1.5 · Recommendation: precision steel pipes 28 x 1.5 to DIN 2391/ISO 3304 · Housing materials: CW614N	E40083
	Progressive ring fitting · Ø 8 mm - G1/2 · Housing materials: stainless steel	E40258
	Progressive ring fitting · Ø 8 mm - G 1/4 · Housing materials: stainless steel	E40259
	Progressive ring fitting · Ø 8 mm - G 3/4 · Housing materials: stainless steel	E40260
	Progressive ring fitting · Ø 8 mm - G 1/2 · Housing materials: stainless steel	E40267
	Progressive ring fitting · Ø 8 mm - G 3/4 · Housing materials: stainless steel	E40268



Process sensors

Type	Description	Order no.
	Progressive ring fitting · Ø 8 mm - 1/2" NPT · Housing materials: stainless steel	E40261
	Progressive ring fitting · Ø 8 mm - 1/4" NPT · Housing materials: stainless steel	E40262
	Progressive ring fitting · Ø 8 mm - R1/2 · Housing materials: stainless steel	E40263
	Progressive ring fitting · Ø 8 mm - R 1/4 · Housing materials: stainless steel	E40264
	Adapter block · D10 / G ¼ · for flow sensors type SID, SF5 · Optimised for the following volumetric flow quantities (factory setting with water): · 0.2...2 l/min (SI1xxx) 0.2...3 l/min (SI5xxx) · Housing materials: stainless steel 316L / 1.4404	E40161
	Adapter block · D16 / G ½ · for flow sensors type SID, SF5 · Optimised for the following volumetric flow quantities (factory setting with water): · 0.5...5 l/min (SI1xxx) 0.5...7 l/min (SI5xxx) · Housing materials: stainless steel 316L / 1.4404	E40162
	Adapter block · D22 / G ¾ · for flow sensors type SID, SF5 · Optimised for the following volumetric flow quantities (factory setting with water): · 1...12 l/min (SI1xxx) 1...16 l/min (SI5xxx) · Housing materials: stainless steel 316L / 1.4404	E40163
	Adapter block · D27 / G 1 · for flow sensors type SID, SF5 · Optimised for the following volumetric flow quantities (factory setting with water): · 2...20 l/min (SI1xxx) 2...25 l/min (SI5xxx) · Housing materials: stainless steel 316L / 1.4404	E40164
	Adapter · M18 x 1.5 - G ½ · Insertion depth of the probe of SID, SFD, TN: · 21 mm · Housing materials: titanium	E40114
	Adapter · M18 x 1.5 - G ¼ · Insertion depth of the probe of SID, SFD, TN: · 13.5 mm · Housing materials: titanium	E40115
	Adapter · M18 x 1.5 - L18 · for mounting in T-pieces · Insertion depth of the probe of SID, SFD, TN: · 28.5 mm · Housing materials: nut: stainless steel 316Ti / 1.4571 / adapter: stainless steel 316L / 1.4404 / O-ring: FKM 16 x 1.5 gr 70° Shore A	E40104
	Adapter · M18 x 1.5 - M12 x 1 · Insertion depth of the probe of SID, SFD, TN: · 13.5 mm · Housing materials: stainless steel 316L / 1.4404	E40101
	Adapter · M18 x 1.5 - M12 x 1 · Insertion depth of the probe of SID, SFD, TN: · 13.5 mm · Housing materials: CW614N	E40100
	Adapter · M18 x 1.5 - ¼" NPT · Insertion depth of the probe of SID, SFD, TN: · 13.9 mm · Housing materials: stainless steel 316L / 1.4404	E40106
	Adapter · M18 x 1.5 - G ¼ · Insertion depth of the probe of SID, SFD, TN: · 13.5 mm · Housing materials: stainless steel 316L / 1.4404	E40099

Type	Description	Order no.
	Adapter · M18 x 1.5 - G 1/4 · Insertion depth of the probe of SID, SFD, TN: · 13.5 mm · Housing materials: CW614N	E40098
	Adapter · M18 x 1.5 - G 1/2 · Insertion depth of the probe of SID, SFD, TN: · 21 mm · Housing materials: stainless steel 316L / 1.4404	E40096
	Adapter · M18 x 1.5 - G 1/2 · Insertion depth of the probe of SID, SFD, TN: · 21 mm · Housing materials: CW614N	E40097
	Mounting adapter · M18 x 1.5 - Ø 23 mm · Insertion depth of the probe of SID, SFD, TN: · 21 mm · Housing materials: PE-100	E40138
	Welding adapter · M18 x 1.5 - Ø 24 mm · Insertion depth of the probe of SID, SFD, TN: · 15 mm · Housing materials: stainless steel 316L / 1.4404	E40124
	Welding adapter · Welding adapter · for compressed air meter type SD · Housing materials: stainless steel 316L / 1.4404	E40195
	Welding adapter · Ø 8 mm - Ø 13.7 mm · Progressive ring fitting · Housing materials: stainless steel	E40265
	Flow adapter (for low flow rates) · M12 x 1 - G 1/8 · for flow sensors and compact flow monitors with adapter · Housing materials: stainless steel 316L / 1.4404	E40129
	Flow adapter (for low flow rates) · M12 x 1 - G 1/8 · for type SA5 · Housing materials: stainless steel 316L / 1.4404	E40434
	Combicon connector · with cage clamps 4 poles · Housing materials: current carrying parts: copper alloy tin-plated	E40171
	Protective cover · for flow sensors type SI5xxx, SI6xxx, SR59xx · Housing materials: PP uncoloured	E40203





Flange adapters for flow sensors

Type	Description	Order no.
	Mounting plate · Housing materials: stainless steel 316L / 1.4404	E40249
	Clamp adapter · Clamp · 1-1.5" · ISO 2852 · for units with Aseptoflex Vario adapter · Sealing by sealing ring · Housing materials: stainless steel 316L / 1.4435	E33201





Process sensors



Type	Description	Order no.
	Clamp adapter · Clamp · 2" · ISO 2852 · for units with Aseptoflex Vario adapter · Sealing by sealing ring · Housing materials: stainless steel 316L / 1.4435	E33202
	Clamp adapter · Clamp · 1-1.5" · ISO 2852 · for units with Aseptoflex Vario adapter · Metal to metal seal · Housing materials: stainless steel 316L / 1.4435	E33701
	Clamp adapter · Clamp · 2" · ISO 2852 · for units with Aseptoflex Vario adapter · Metal to metal seal · Housing materials: stainless steel 316L / 1.4435	E33702
	Pipe fitting · Hygienic pipe fitting · Hygienic pipe fitting · DN32 (1.25") · DIN 11851 · for units with Aseptoflex Vario adapter · Sealing by sealing ring · Housing materials: stainless steel 316L / 1.4435	E33211
	Pipe fitting · Hygienic pipe fitting · Hygienic pipe fitting · DN40 (1.5") · DIN 11851 · for units with Aseptoflex Vario adapter · Sealing by sealing ring · Housing materials: stainless steel 316L / 1.4435	E33212
	Pipe fitting · Hygienic pipe fitting · Hygienic pipe fitting · DN50 (2") · DIN 11851 · for units with Aseptoflex Vario adapter · Sealing by sealing ring · Housing materials: stainless steel 316L / 1.4435	E33213
	Pipe fitting · Hygienic pipe fitting · Hygienic pipe fitting · DN32 (1.25") · DIN 11851 · for units with Aseptoflex Vario adapter · Metal to metal seal · Housing materials: stainless steel 316L / 1.4435	E33711
	Pipe fitting · Hygienic pipe fitting · Hygienic pipe fitting · DN40 (1.5") · DIN 11851 · for units with Aseptoflex Vario adapter · Metal to metal seal · Housing materials: stainless steel 316L / 1.4435	E33712
	Pipe fitting · Hygienic pipe fitting · Hygienic pipe fitting · DN50 (2") · DIN 11851 · for units with Aseptoflex Vario adapter · Metal to metal seal · Housing materials: stainless steel 316L / 1.4435	E33713
	Clamp adapter · Varivent Adapter · Varivent type F · DN25 (1"), D = 50 · for units with Aseptoflex Vario adapter · Sealing by sealing ring · Housing materials: stainless steel 316L / 1.4435	E33221
	Clamp adapter · Varivent Adapter · Varivent type N · DN40...DN150 (1.5...6"), D = 68 · for units with Aseptoflex Vario adapter · Sealing by sealing ring · Housing materials: stainless steel 316L / 1.4435	E33222
	Clamp adapter · Varivent Adapter · Varivent type F · DN25 (1"), D = 50 · for units with Aseptoflex Vario adapter · Metal to metal seal · Housing materials: stainless steel 316L / 1.4435	E33721
	Clamp adapter · Varivent Adapter · Varivent type N · DN40...DN150 (1.5...6"), D = 68 · for units with Aseptoflex Vario adapter · Metal to metal seal · Housing materials: stainless steel 316L / 1.4435	E33722
	Pipe fitting · SMS pipe fitting · DN40 (1.5") · SMS · for units with Aseptoflex Vario adapter · Metal to metal seal · Housing materials: stainless steel 316L / 1.4435	E33731
	Pipe fitting · SMS pipe fitting · DN50 (2") · SMS · for units with Aseptoflex Vario adapter · Metal to metal seal · Housing materials: stainless steel 316L / 1.4435	E33732

Type	Description	Order no.
	Flange adapter · DRD adapter · flange · DRD · D = 65 · for units with Aseptoflex Vario adapter · Sealing by sealing ring · Housing materials: stainless steel 316L / 1.4435	E33242
	Welding adapter · Ø 50 mm · for units with Aseptoflex Vario adapter · Sealing by sealing ring · Housing materials: stainless steel 316L / 1.4435	E30122
	Adapter · G 1 - 2" TRICLAMP · for flow monitor type SM8 · Housing materials: stainless steel 316L / 1.4404	E40252
	Adapter · G 1 - 1.5" TRICLAMP · for flow monitor type SM8 · Housing materials: stainless steel 316L / 1.4404	E40253
	Adapter · G 2 - 2" TRICLAMP · for flow sensors type SM2, SM9 · Housing materials: stainless steel 316L / 1.4404	E40254

Accessories for airflow monitors













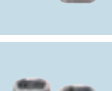
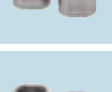

Type	Description	Order no.
	Mounting clamp · Ø 23 mm · for air flow monitor SLG · Housing materials: PBT	E40048
	Adapter for E40048 · Ø 8 mm - Ø 23 mm · Housing materials: stainless steel	E40269

Accessories for flow meters

Type	Description	Order no.
	Adapter · G 1/2 - R 1/2 · for flow monitor type SM6 · flat seal · Housing materials: stainless steel 316Ti / 1.4571	E40199
	Adapter · G 1/2 - G 3/4 · for flow monitor type SM6 · flat seal · Housing materials: stainless steel 316L / 1.4404	E40189
	Adapter · G 3/4 - R 1/2 · for flow monitor type SM7 / SU7 · Housing materials: stainless steel 316L / 1.4404	E40178
	Adapter · G 1 - R 1/2 · for flow monitor type SM8 / SU8 · Housing materials: stainless steel 316L / 1.4404	E40179
	Adapter · G 1 - R 3/4 · for flow monitor type SM8 / SU8 · Housing materials: stainless steel 316L / 1.4404	E40180



Process sensors

Type	Description	Order no.
	Adapter · G ¾ I - R ½ · for flow monitor type SM7 / SU7 · Housing materials: Brass	E40151
	Adapter · G 1 - R ¾ · for flow monitor type SM8 / SU8 · Housing materials: Brass	E40153
	Adapter · G 1¼ - R 1 · for flow monitor type SU9 · Housing materials: stainless steel 316L / 1.4404	E40205
	Adapter · G ½ - G ½ · for flow monitor type SM6 · Housing materials: stainless steel 316L / 1.4404	E40213
	Adapter · G ¾ - G ½ · for flow monitor type SM7 / SU7 · Housing materials: stainless steel 316L / 1.4404	E40214
	Adapter · G 1 - G ¾ · for flow monitor type SM8 / SU8 · Housing materials: stainless steel 316L / 1.4404	E40215
	Adapter · G ¾ - G ¾ · for flow monitor type SM7 / SU7 · Housing materials: stainless steel 316L / 1.4404	E40216
	Adapter · G 1 - G 1 · for flow monitor type SM8 / SU8 · Housing materials: stainless steel 316L / 1.4404	E40217
	Adapter · Victaulic · for flow sensors type SM2, SM9 · Housing materials: stainless steel 316Ti / 1.4571	E40227
	Adapter · 2" NPT · for flow sensors type SM2, SM9 · Housing materials: stainless steel 316Ti / 1.4571	E40228
	Adapter · 1½" NPT · for flow sensors type SM2, SM9 · Housing materials: stainless steel 316Ti / 1.4571	E40229
	Adapter · G 1½ · for flow sensors type SM2, SM9 · Housing materials: stainless steel 316Ti / 1.4571	E40230
	Adapter · R 2" A · for flow sensors type SM2, SM9 · Housing materials: stainless steel 316Ti / 1.4571	E40231
	Flange adapter · Flange adapter · Adapter · rotatable · for type SM2, SM9 · Housing materials: flange: stainless steel / adapter: stainless steel 316Ti / 1.4571 / O-ring: EPDM	E40240
	Regulating valve · G ½ - G ½ · lockable · Housing materials: Brass nickel-plated / EPDM	E40250

Type	Description	Order no.
------	-------------	-----------



Regulating valve · G 3/4 - G 3/4 · lockable · Housing materials: Brass nickel-plated / EPDM

E40251

Grounding clamps for magnetic-inductive flow meters

Type	Description	Order no.
------	-------------	-----------



Grounding clamp · Housing materials: stainless steel 316L / 1.4404

E40234

Wiring diagrams

Core colours

- BK black
- BN brown
- BU blue
- WH white
- GY grey

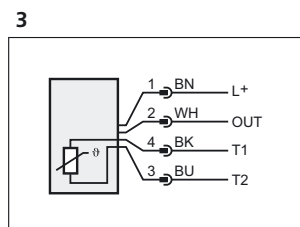
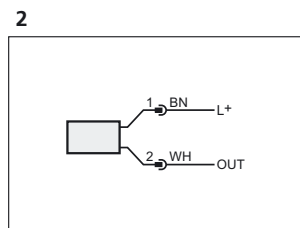
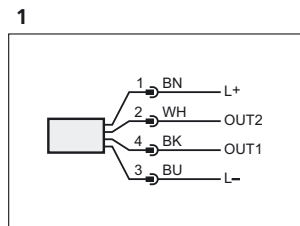

OUT: Analogue output, T1 / T2: Pt1000: -

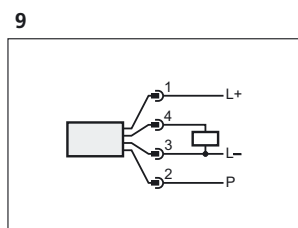
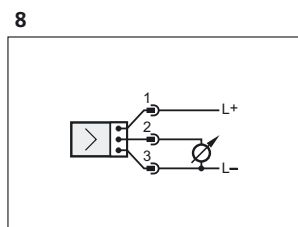
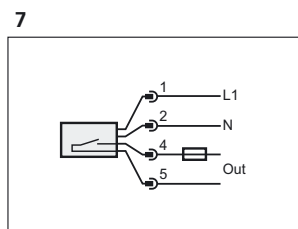
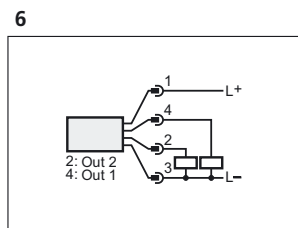
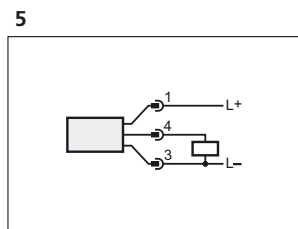
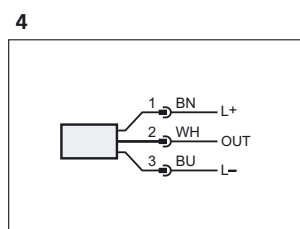

P = programming wire (for remote adjustment)

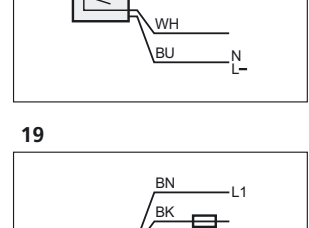
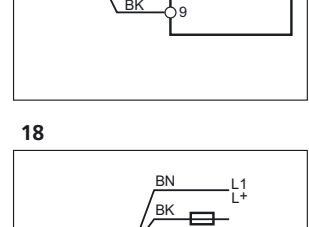
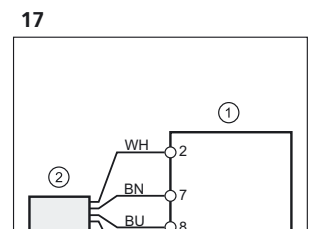
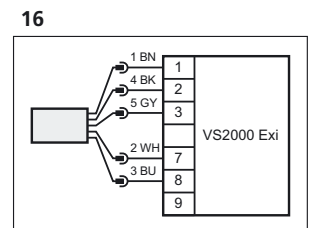
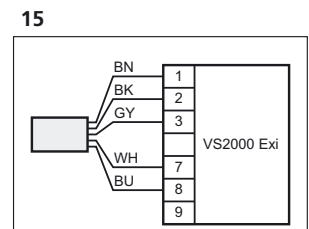
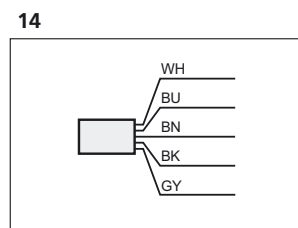
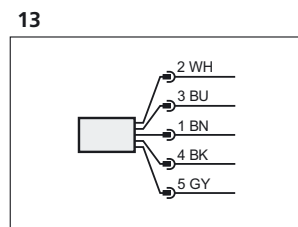
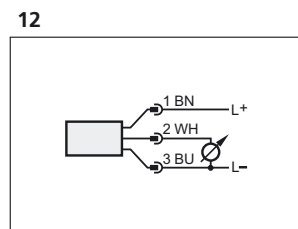
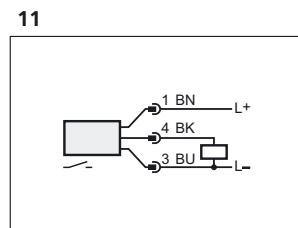
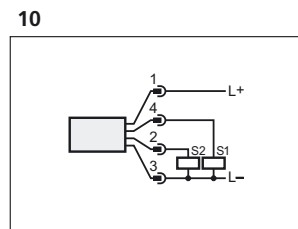



Process sensors

Wiring diagrams

20

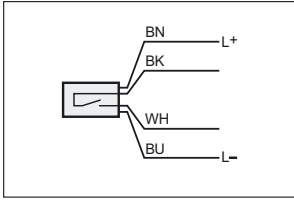

21

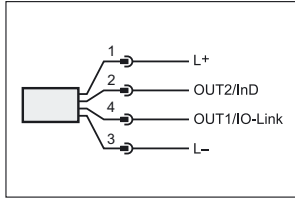

22

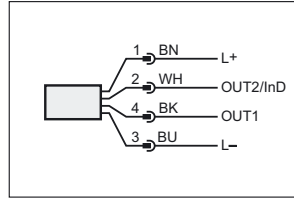

23

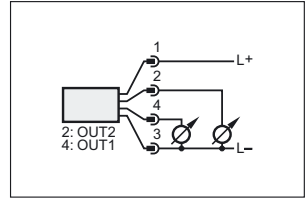

24

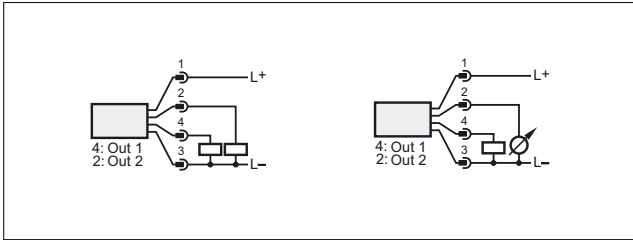

Scale drawings / drawing no. – CAD download: www.ifm.com

1

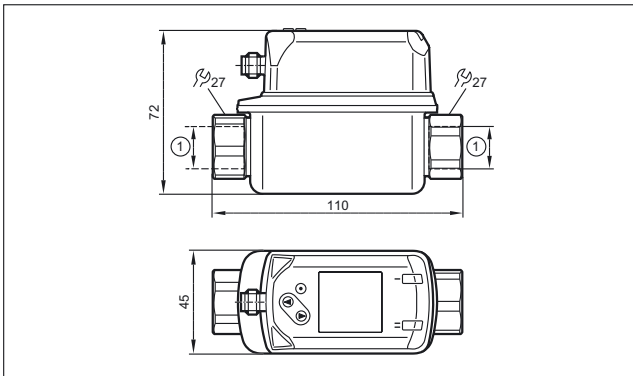

1: Process connection, see data sheet

3

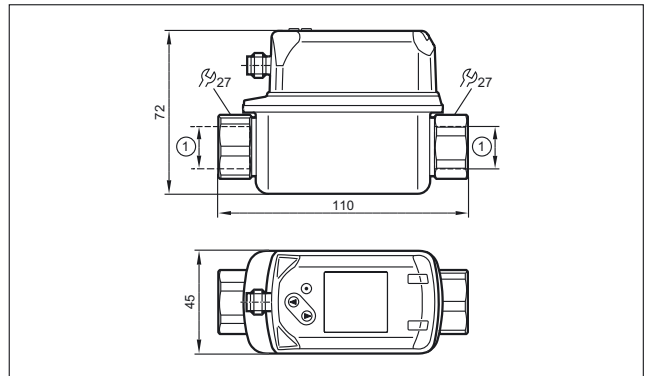

4

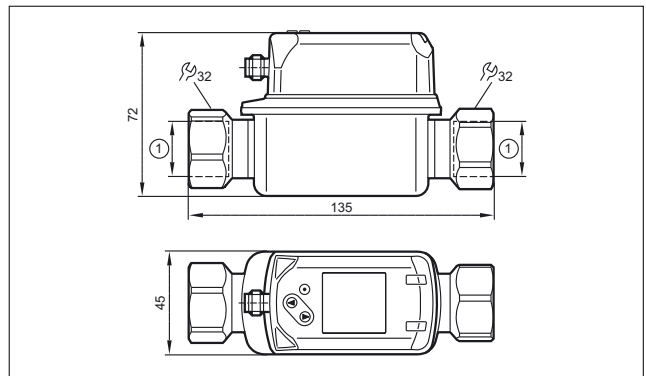

2

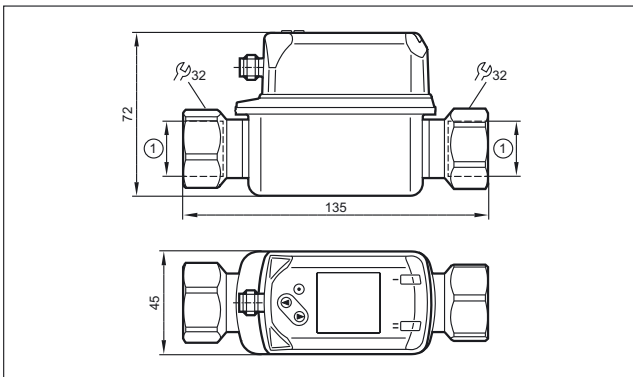

1: Process connection, see data sheet

5

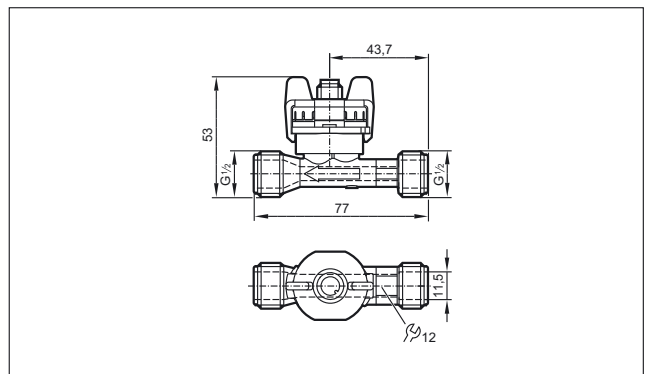

Scale drawings / drawing no. – CAD download: www.ifm.com

6

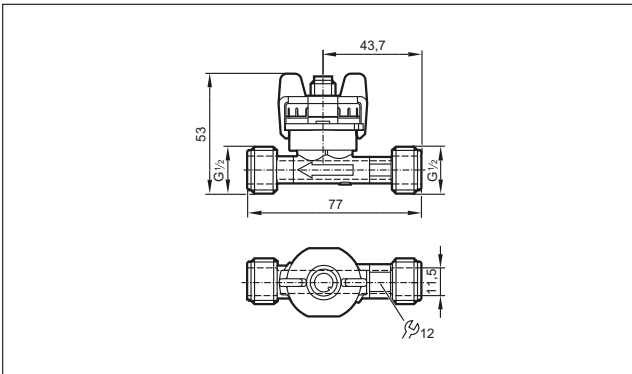

7

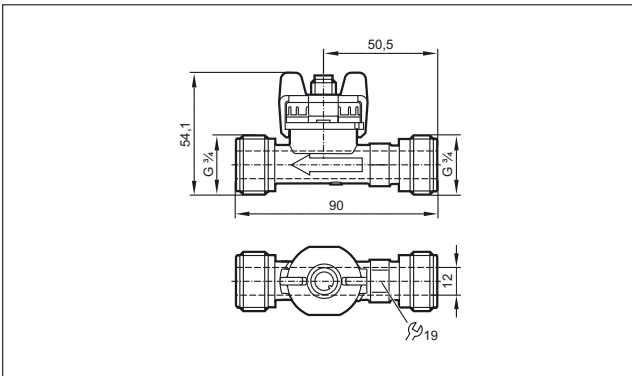

8

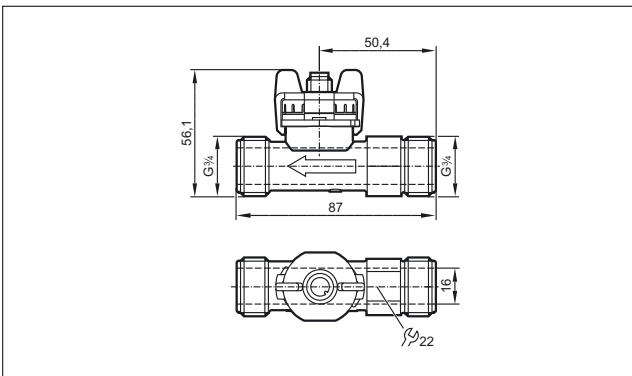

9

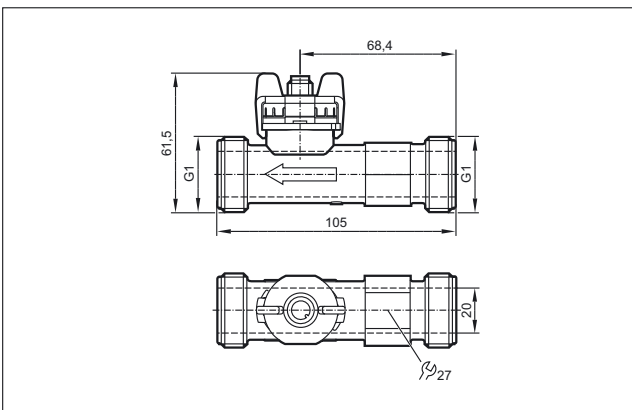

10

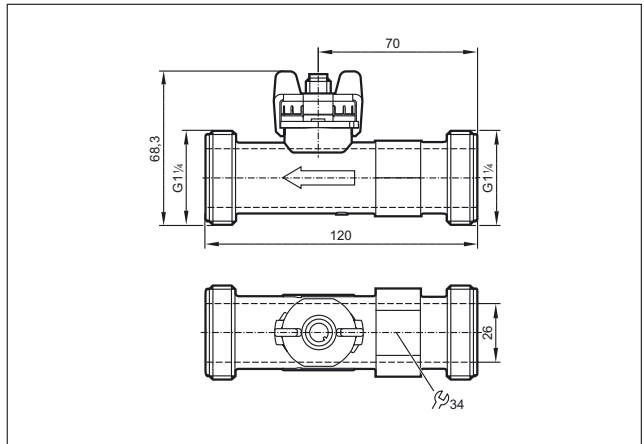

11

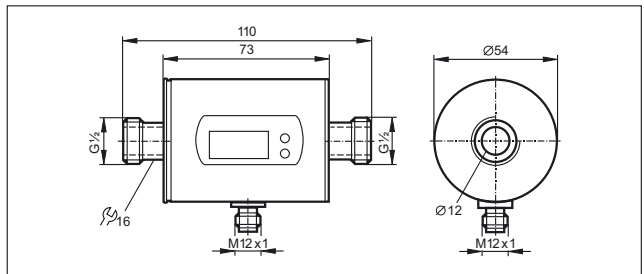

12

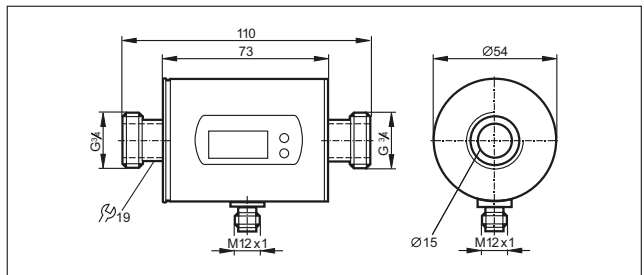

13

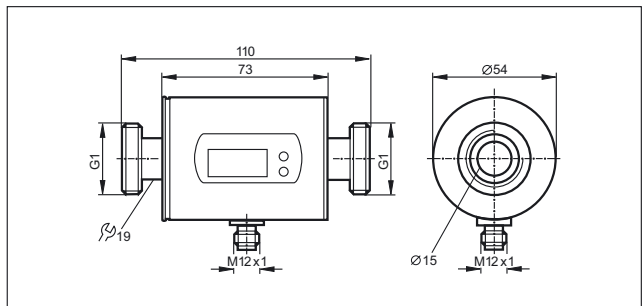



Process sensors

Scale drawings / drawing no. – CAD download: www.ifm.com

14

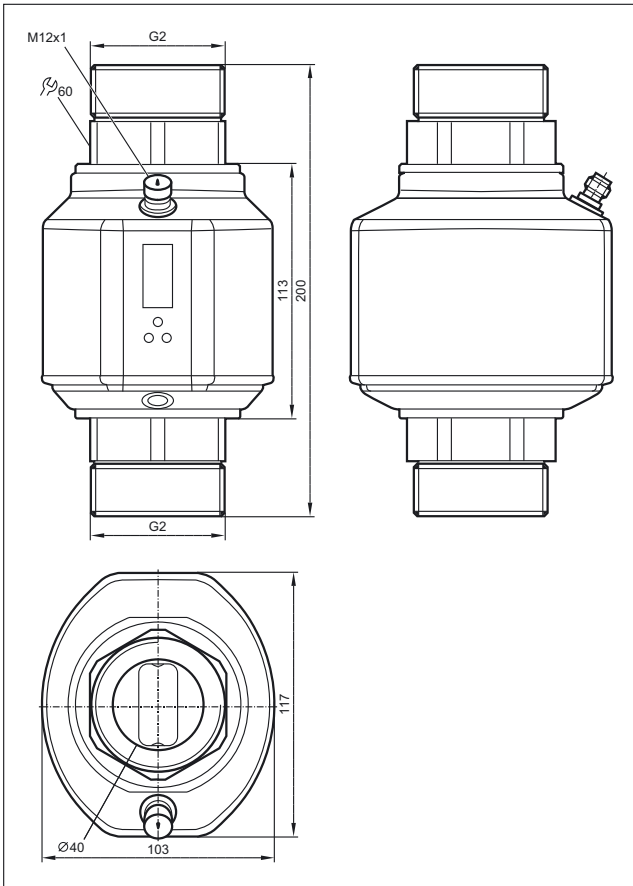

15

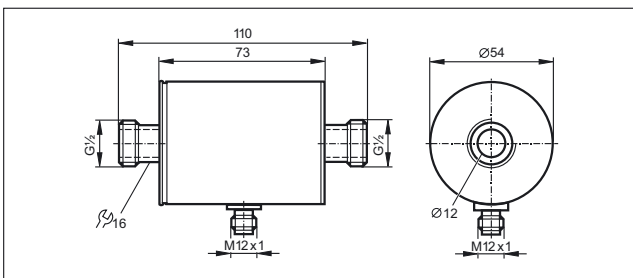

16

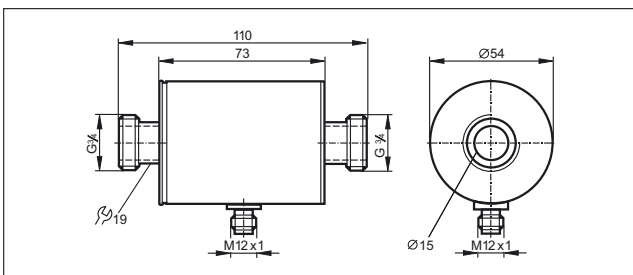

17

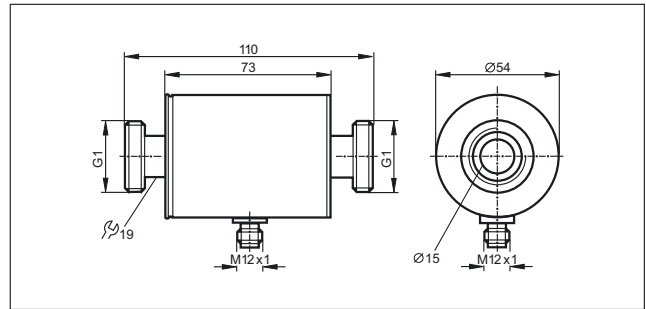

18

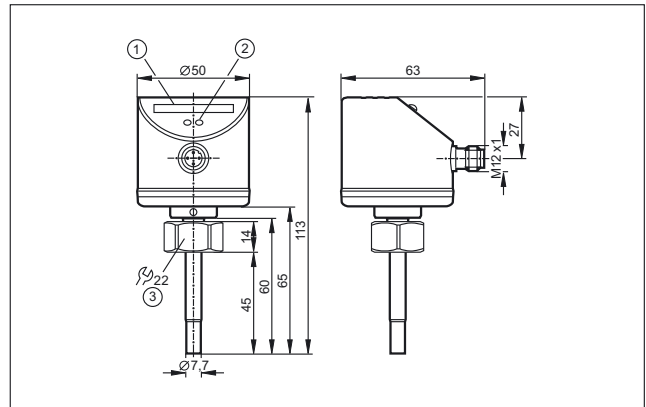

1: LED display, 2: setting pushbutton, 3: tightening torque 25 Nm

19

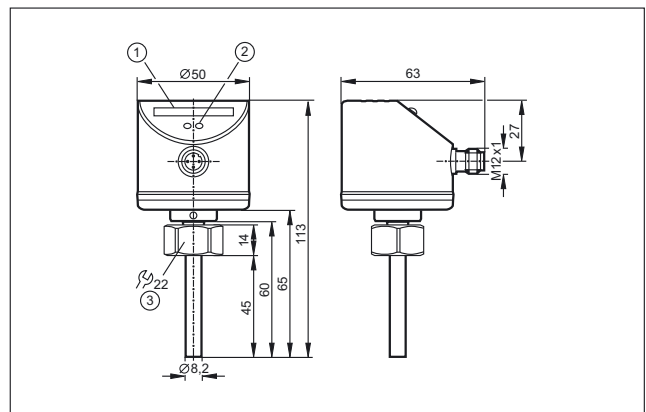

1: LED display, 2: setting pushbutton, 3: tightening torque 25 Nm

20

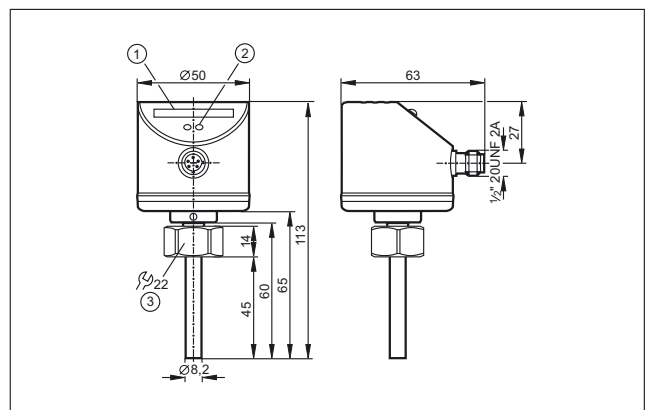

1: LED display, 2: setting pushbutton, 3: tightening torque 25 Nm

Scale drawings / drawing no. – CAD download: www.ifm.com

21

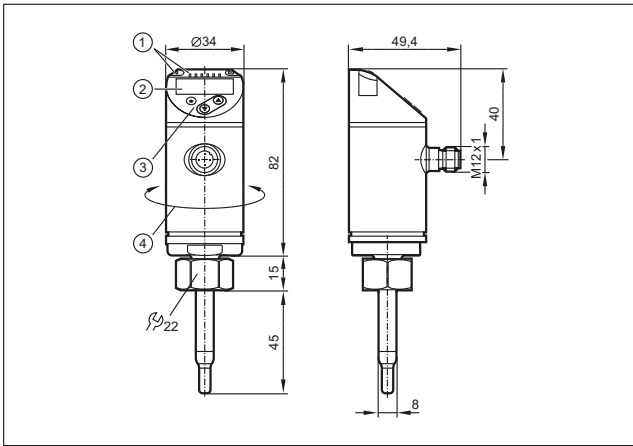

1: LEDs (display unit / switching status), 2: 4-digit alphanumeric display / alternating indication of red and green, 3: Programming buttons, 4: Upper part of the housing can be rotated by 345°

22

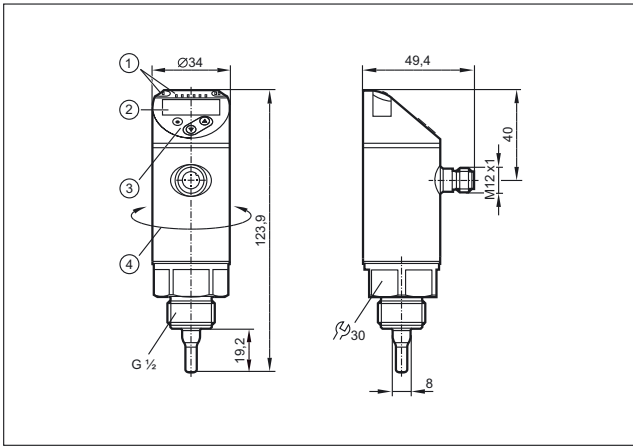

23

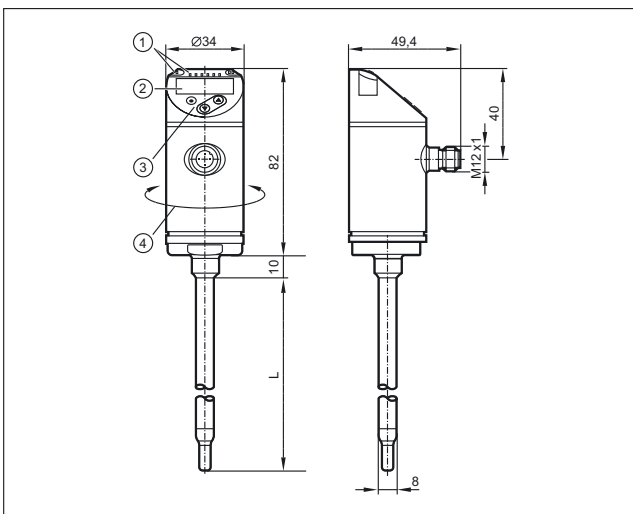

24

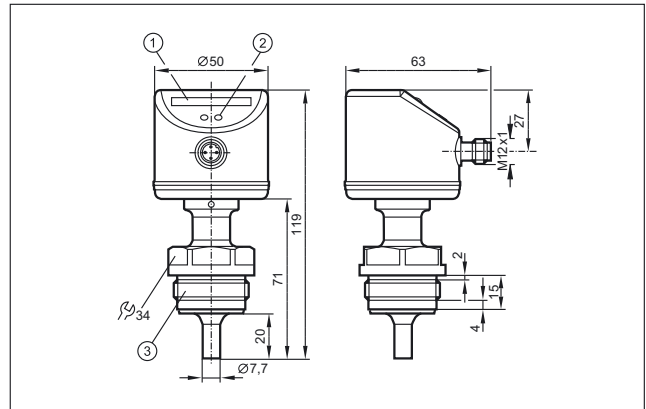

1: LED display, 2: setting pushbutton, 3: G1/Aseptoflex Vario thread

25

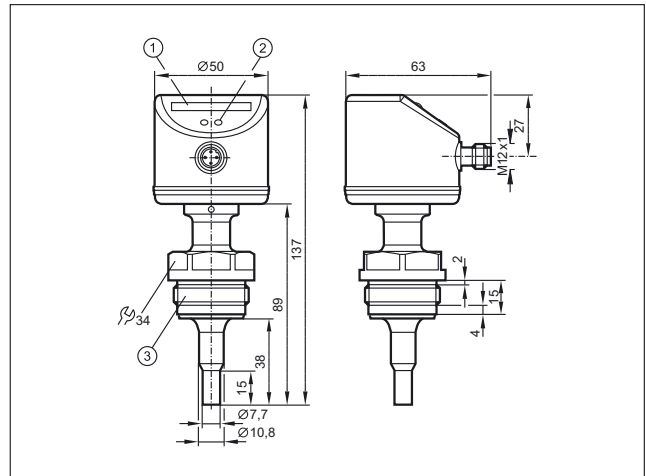

1: LED display, 2: setting pushbutton, 3: G1/Aseptoflex Vario thread

26

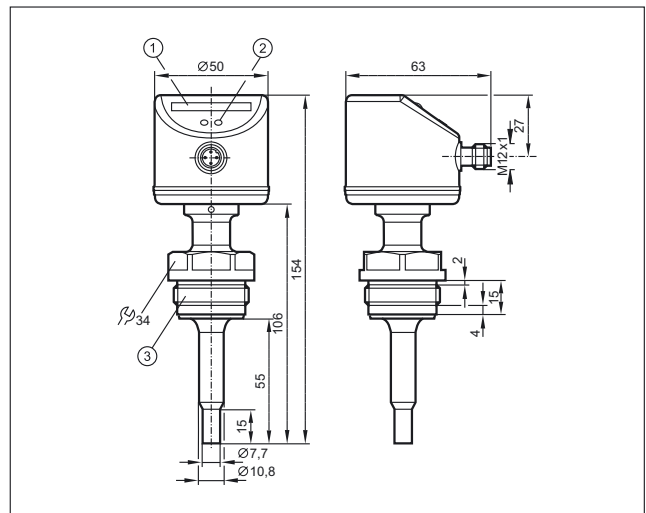

1: LED display, 2: setting pushbutton, 3: G1/Aseptoflex Vario thread



Process sensors

Scale drawings / drawing no. – CAD download: www.ifm.com

27

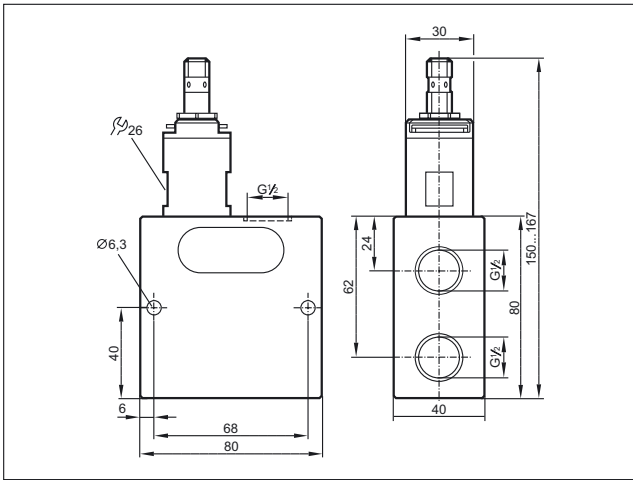

31

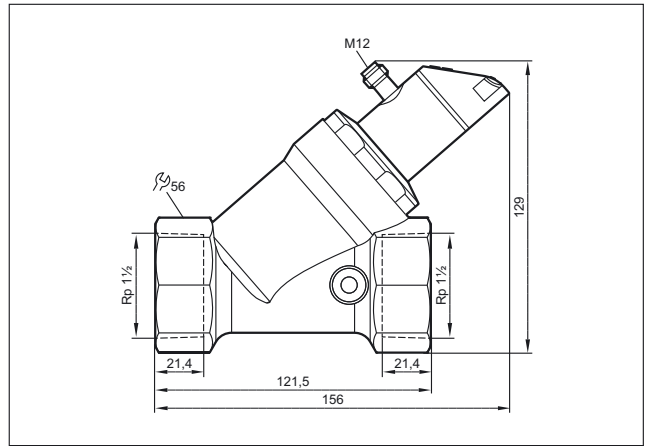

28

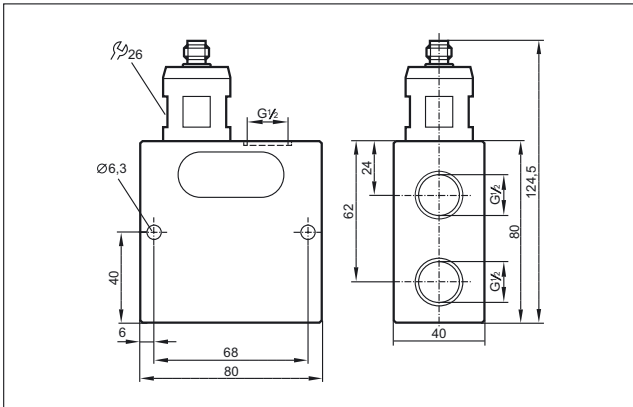

32

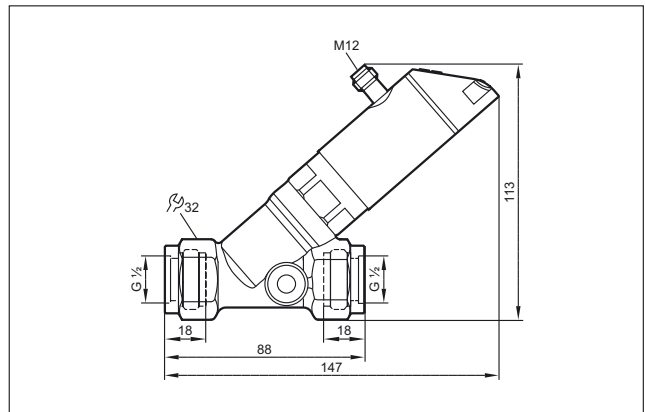

29

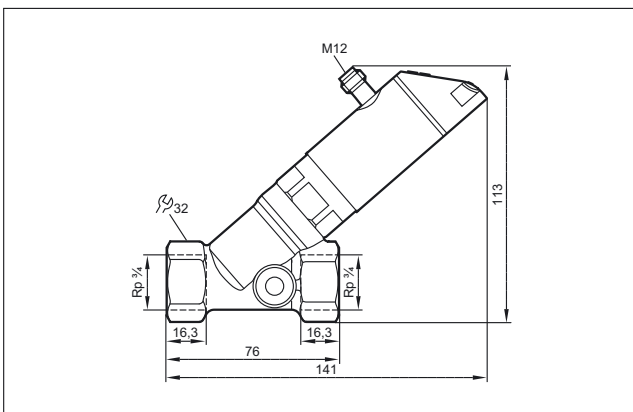

33

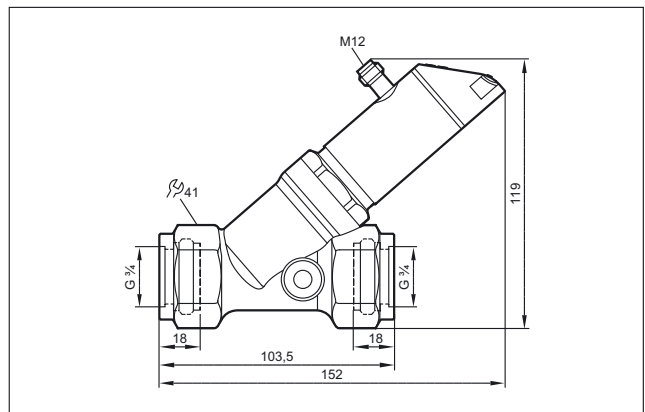

30

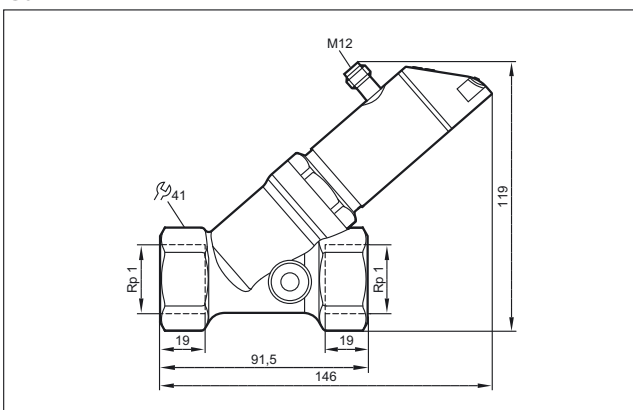

34

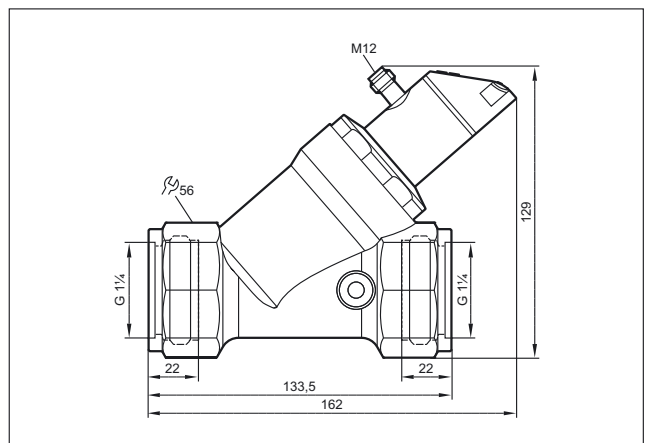

Scale drawings / drawing no. – CAD download: www.ifm.com

35

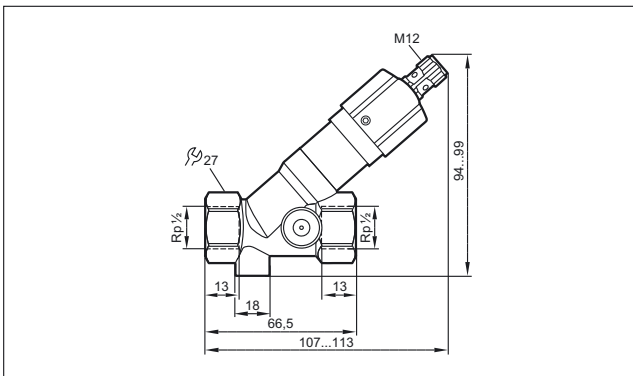

39

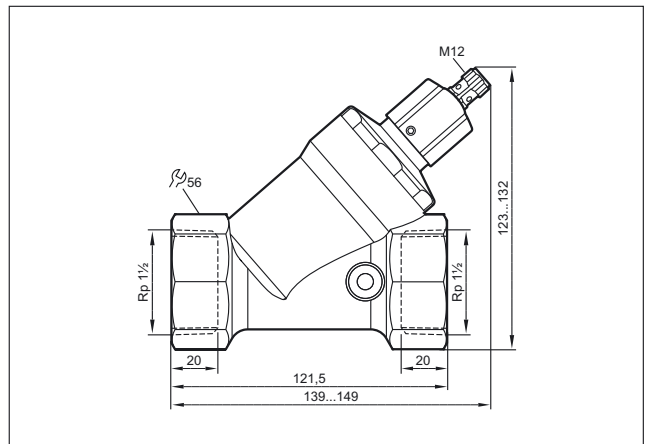

36

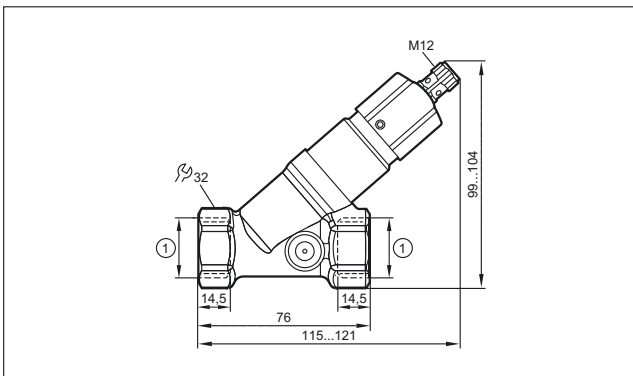

40

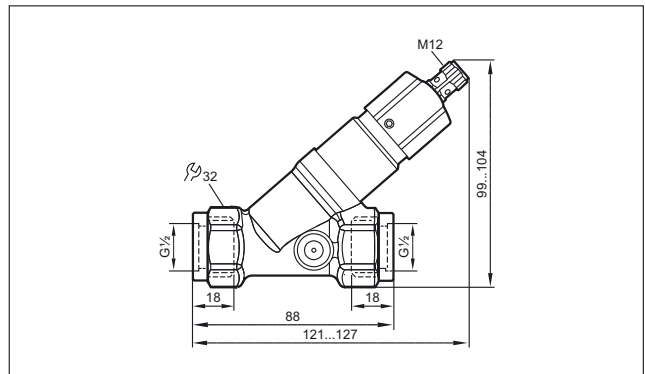

37

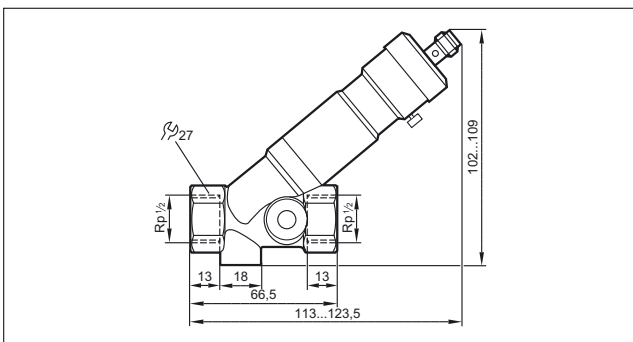

41

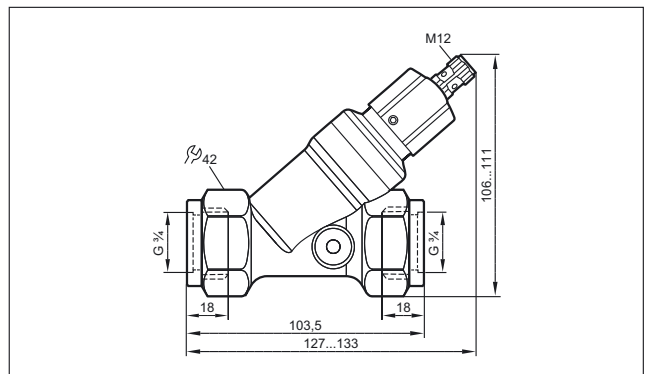

38

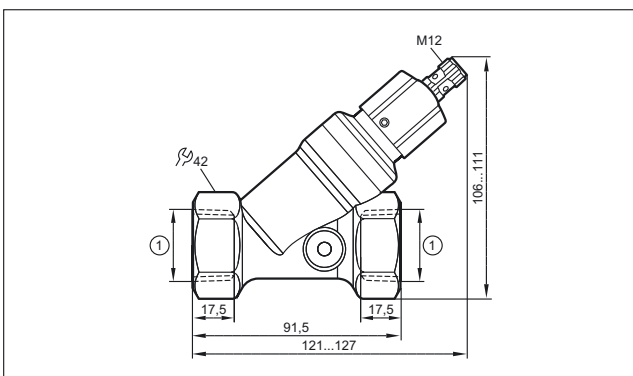

42

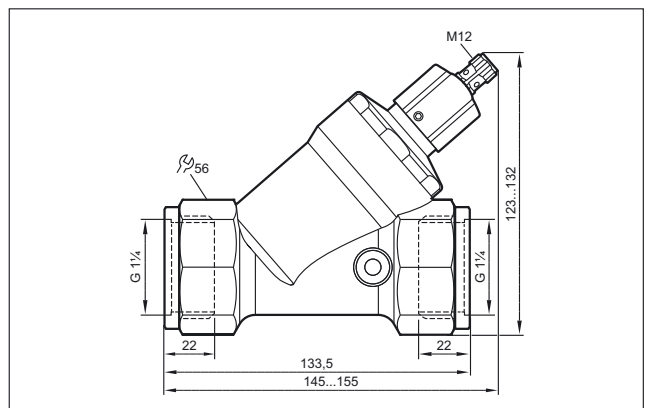



Process sensors

Scale drawings / drawing no. – CAD download: www.ifm.com

43

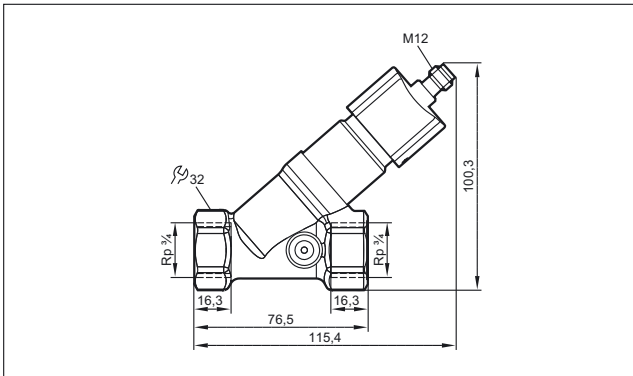

44

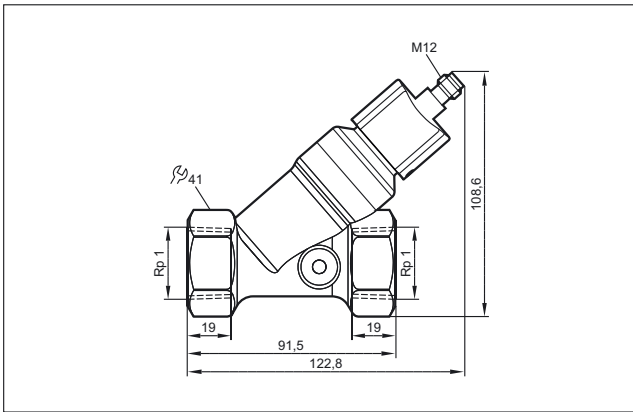

45

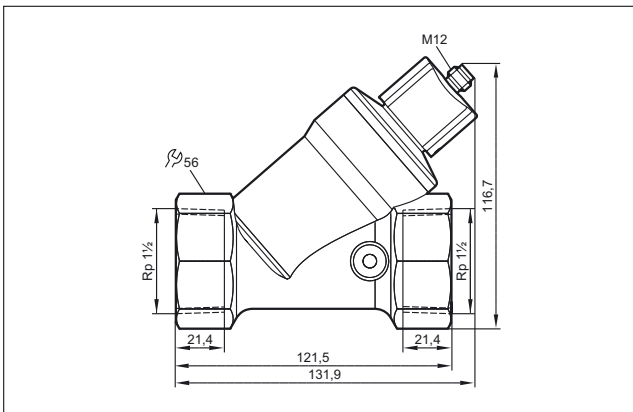

46

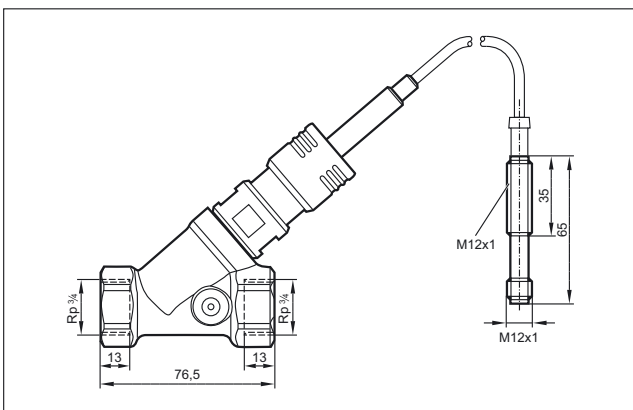

47

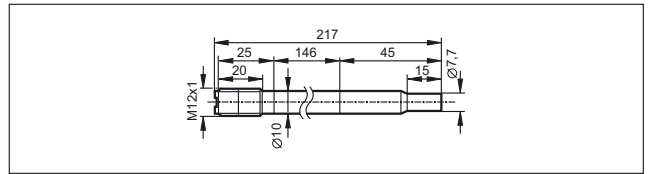

48

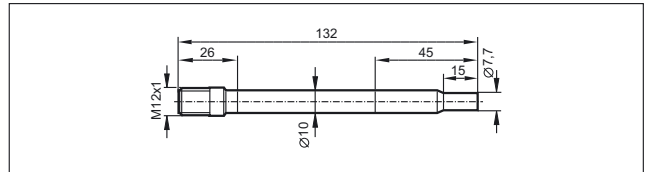

49

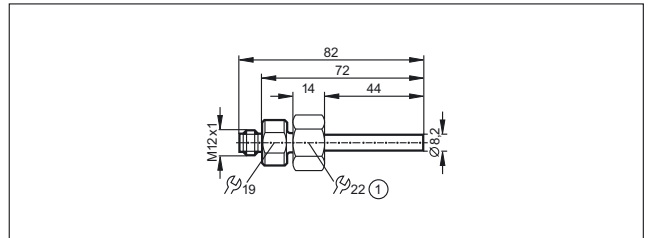

1: internal thread M18 x 1.5

50

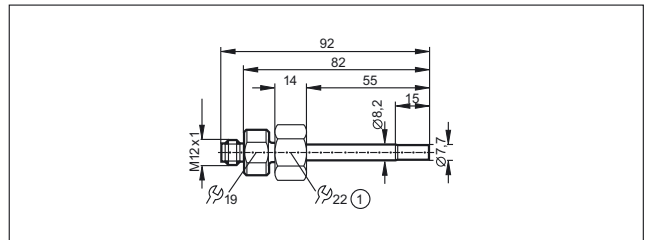

internal thread M18 x 1.5

51

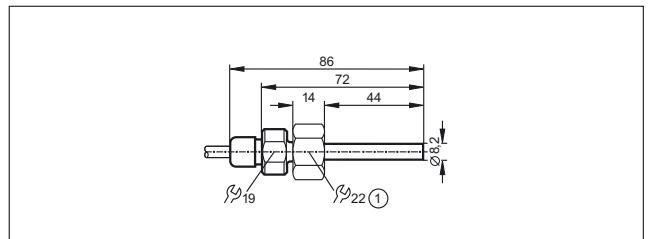

1: internal thread M18 x 1.5

52

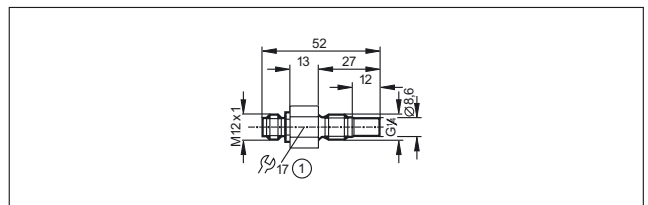

1: tightening torque max. 8 Nm

Scale drawings / drawing no. – CAD download: www.ifm.com

53

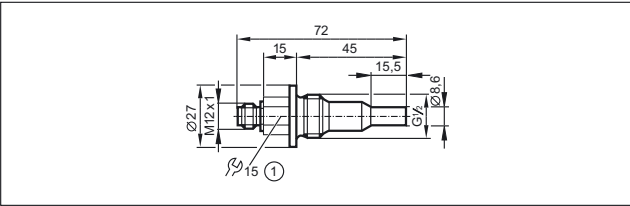

1: tightening torque max. 30 Nm

54

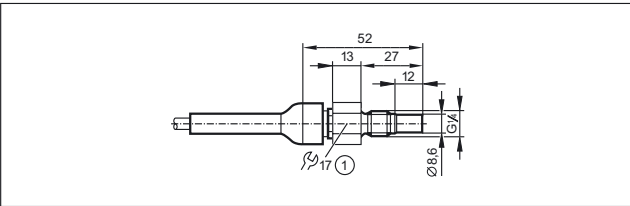

1: tightening torque max. 8 Nm

55

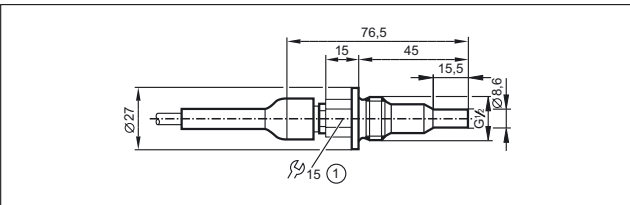

1: tightening torque max. 30 Nm

56

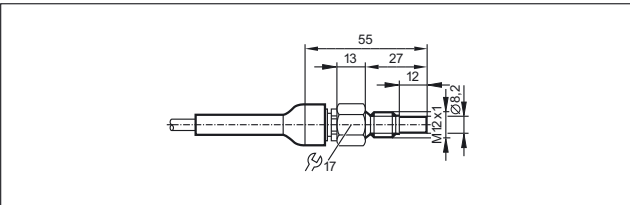

57

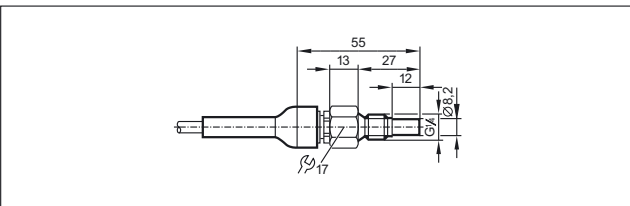

58

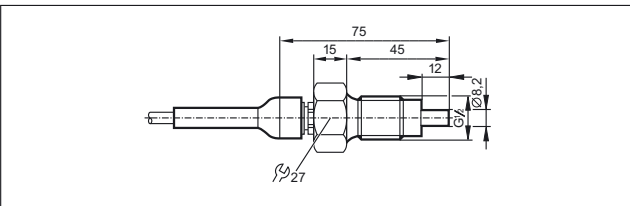

59

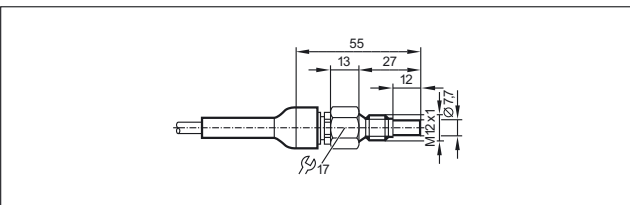

60

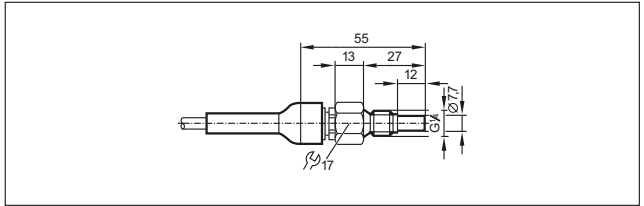

61

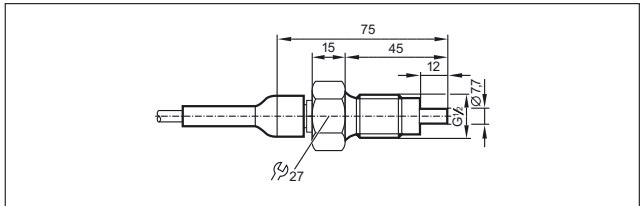

62

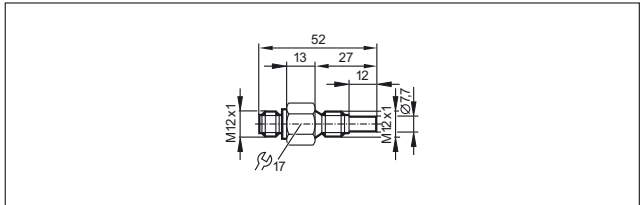

63

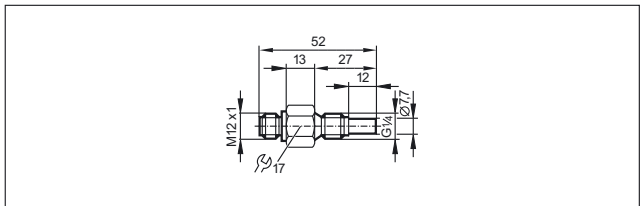

64

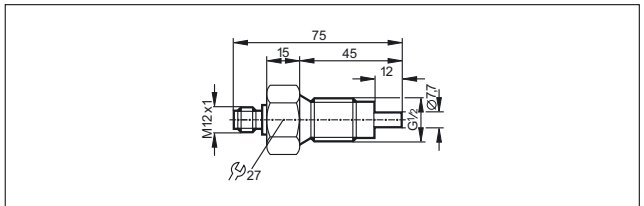

65

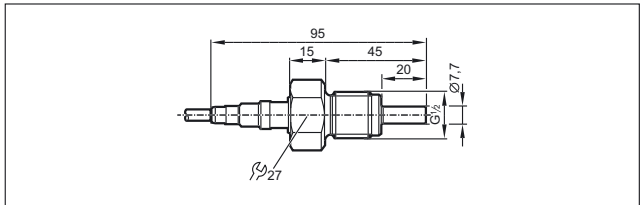

66

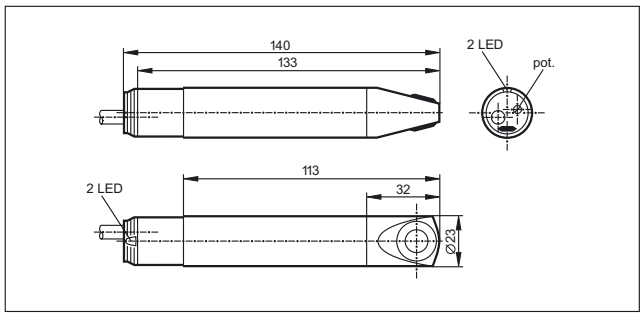



Process sensors

Scale drawings / drawing no. – CAD download: www.ifm.com

67

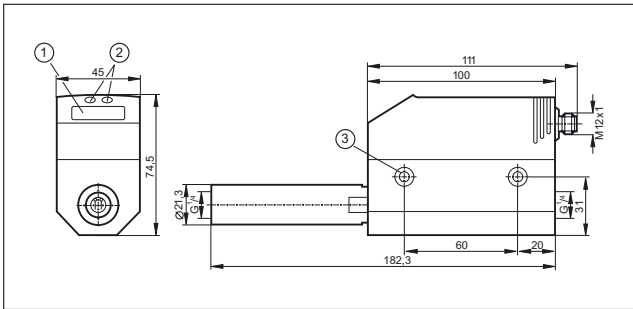

1: 4-digit alphanumeric display, 2: Programming buttons, 3: hole for M5 fixing screw

68

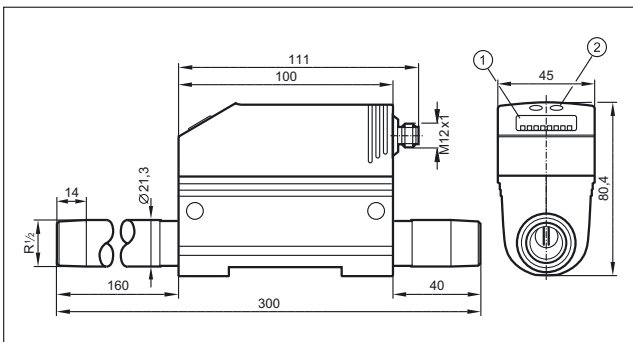

1: 4-digit alphanumeric display, 2: Programming buttons

69

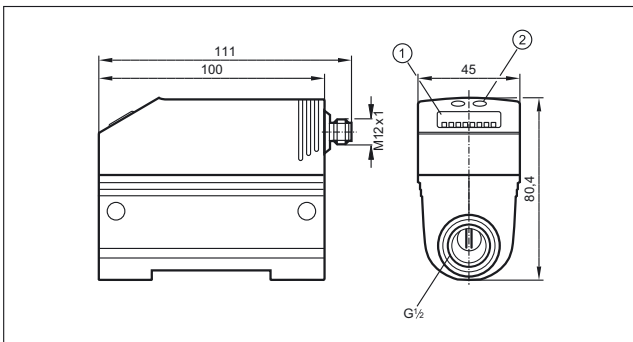

1: 4-digit alphanumeric display, 2: Programming buttons

70

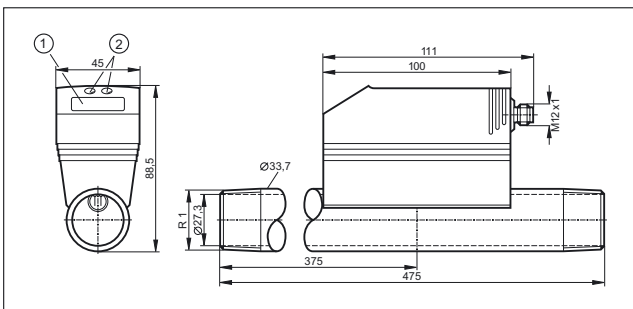

1: 4-digit alphanumeric display, 2: Programming buttons

71

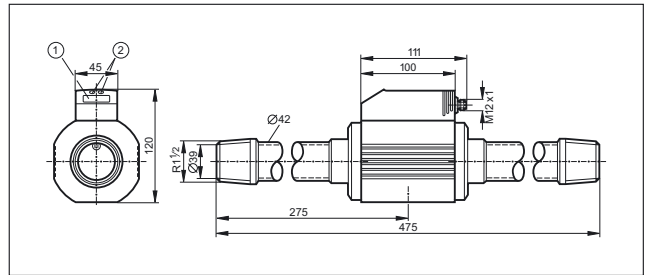

1: 4-digit alphanumeric display, 2: Programming buttons

72

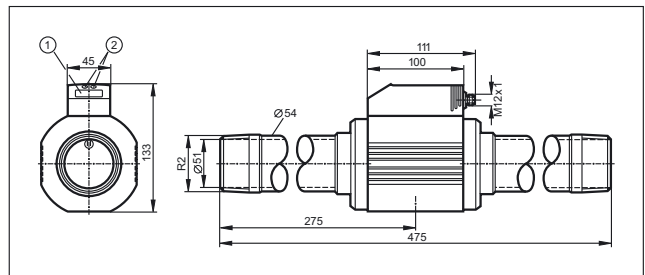

1: 4-digit alphanumeric display, 2: Programming buttons

73

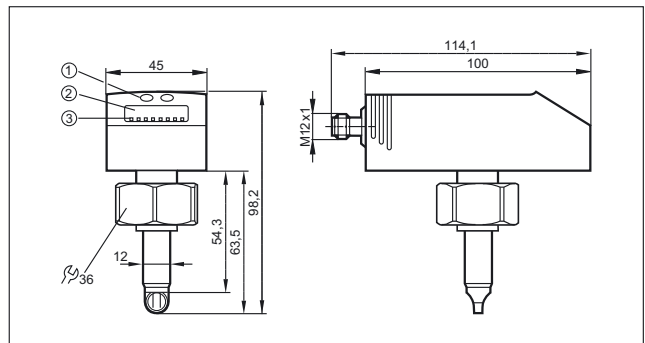

1: Programming buttons, 2: 4-digit alphanumeric display, 3: status LEDs

74

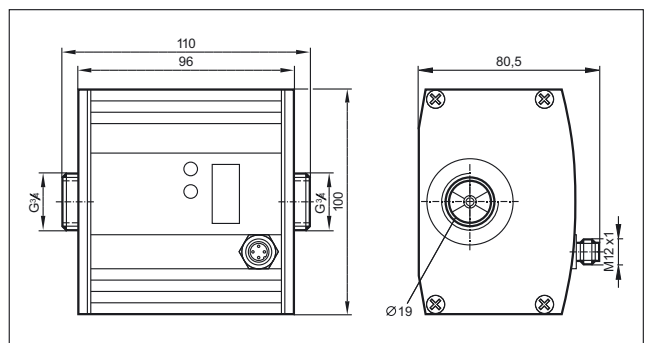

installation length with pipe adapter E40151 / E40154: 185 mm

Scale drawings / drawing no. – CAD download: www.ifm.com

75

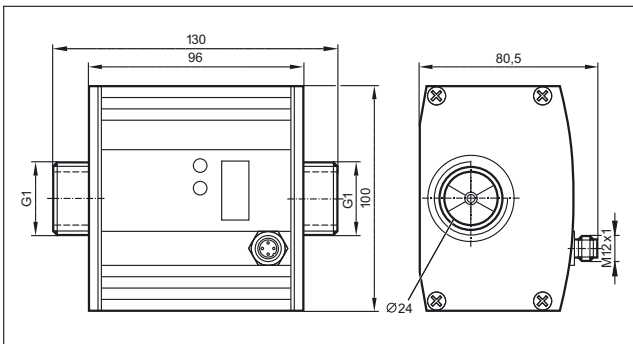

installation length with pipe adapter E40152 / E40155: 205 mm,
 installation length with pipe adapter E40153 / E40156: 215 mm

76

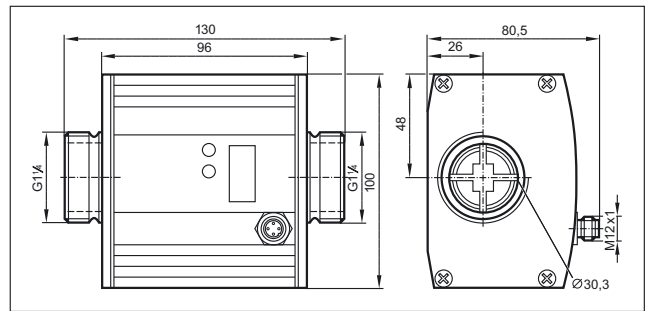



Process sensors

Solid and reliable level sensors without any mechanical parts



Level sensors



High reliability due to the absence of mechanical components

Measurement technique: guided wave radar, capacitive and hydrostatic

Outputs for continuous or point level measurement

Integrated LED display for local indication of the current level

Suitable for common industrial and process fluids



Level sensors

In industrial applications where fluids or bulk material are used, storage tanks or silos are used for processing or storing media. Sensors are used to detect levels. Even critical process conditions such as emptying a hydraulic tank or the unintentional overspill of a tank are monitored using level sensors.

Advantages of electronic sensors

Deposits and wear and tear often lead to failures in particular if mechanical switches are in contact with the medium. The electronic ifm sensors can do without any mechanical parts. This makes the sensors especially robust and reliable. Another advantage of electronic sensors is the local indication of the level or the easy setting of the switching threshold simply by pressing a button.

System overview	Page
Point level sensors for oils and lubricants	520
Electronic level sensors for oils and coolants, approval to the German Federal Water Act (WHG), section 19	520
Electronic level sensors for oils and coolants	521
Point level sensors for oils and coolants, approval to the German Federal Water Act (WHG), section 19	522
Point level sensors for oils and lubricants	522
Point level sensors for oils and coolants, approval to the German Federal Water Act (WHG), section 19	523
Point level sensors for hygienic areas	523 - 524
Point level sensors for the hazardous areas	524
Variable level sensors, guided wave radar, hygienic areas	524
Variable level sensors, guided wave radar, industrial applications	524 - 525
Compact sensors for level and temperature monitoring	525 - 526
Sensors for hydrostatic level monitoring	526 - 527
Sensors for hydrostatic level monitoring ATEX category 1G/1D	527
Sensors for hydrostatic level monitoring in hygienic and wet areas	527 - 529
Accessories for level sensors LK, LT, LL, LI	529 - 530
Parameter-setting system	530
Software	531
Certificates	531
Accessories for LMT level sensors	531 - 533
Accessories for LMC level sensors	533
Accessories for level sensors LR	533 - 534
LR probes for standard applications	534 - 535
LR probes for hygienic areas	535
LR coaxial pipes	535 - 537
Hygienic adapters	537
Accessories for level sensors PA, PG, PI, PN, PS, PY	538
Wiring diagrams	538 - 539
Scale drawings / drawing no. – CAD download: www.ifm.com	539 - 543



Process sensors

Point level sensors for oils and lubricants

Type	Process connection	Output	U _b [V]	Medium temperature [°C]	I _{load} [mA]	Drawing no.	Order no.
------	--------------------	--------	-----------------------	----------------------------	---------------------------	-------------	-----------

M12 connector · Application water, water-based media · Wiring diagram no. 1 · Connector groups 8, 9, 10, 11, 18, 19, 21, 23, 25, 148, 149, 150, 151, 153, 154, 184, 188, 190, 193, 202, 203, 204

	G 1/2 A	OUT1: normally open / closed programmable / IO-Link OUT2: normally open / closed programmable PNP / NPN	18...30	-25...100	50	1	LMC100
	G 1/2 A	OUT1: normally open / closed programmable / IO-Link OUT2: normally open / closed programmable PNP / NPN	18...30	-25...100	50	2	LMC400
	1/2" NPT	OUT1: normally open / closed programmable / IO-Link OUT2: normally open / closed programmable PNP / NPN	18...30	-25...100	50	3	LMC500

M12 connector · Application oils, oil-based media · Wiring diagram no. 1 · Connector groups 8, 9, 10, 11, 18, 19, 21, 23, 25, 148, 149, 150, 151, 153, 154, 184, 188, 190, 193, 202, 203, 204

	G 1/2 A	OUT1: normally open / closed programmable / IO-Link OUT2: normally open / closed programmable PNP / NPN	18...30	-25...100	50	1	LMC110
	G 1/2 A	OUT1: normally open / closed programmable / IO-Link OUT2: normally open / closed programmable PNP / NPN	18...30	-25...100	50	2	LMC410
	1/2" NPT	OUT1: normally open / closed programmable / IO-Link OUT2: normally open / closed programmable PNP / NPN	18...30	-25...100	50	3	LMC510

M12 connector · Application liquids, viscous media and powders · Wiring diagram no. 11 · Connector groups 8, 9, 10, 11, 18, 19, 21, 23, 25, 148, 149, 150, 151, 153, 154, 184, 188, 190, 193, 202, 203, 204

	1/2" NPT	2 x normally open / closed programmable PNP / NPN	18...30	-	100	4	LMC502
--	----------	---	---------	---	-----	---	--------













Electronic level sensors for oils and coolants, approval to the German Federal Water Act (WHG), section 19

Type	Probe length [mm]	Active zone [mm]	Inactive zone [mm]	U _b [V]	Medium temperature water [°C]	Medium temperature oil [°C]	I _{load} [mA]	Drawing no.	Order no.
------	----------------------	---------------------	-----------------------	-----------------------	----------------------------------	--------------------------------	---------------------------	-------------	-----------

M12 connector · Output function 1 x normally open / closed progr. (OUT1) 1 x normally closed (OUT-OP, overflow output) · DC PNP · Wiring diagram no. 2 · Connector groups 8, 9, 10, 11, 18, 19, 21, 23, 25, 148, 149, 150, 151, 153, 154, 184, 188, 190, 193, 202, 203, 204

	264	195	53 / 15	12...30	0...35	0...65	200	5	LK1222
	472	390	53 / 30	12...30	0...35	0...65	200	5	LK1223
	728	585	102 / 40	12...30	0...35	0...65	200	5	LK1224

Electronic level sensors for oils and coolants

Type	Probe length [mm]	Active zone [mm]	Inactive zone [mm]	U _b [V]	Medium temperature water [°C]	Medium temperature oil [°C]	I _{load} [mA]	Drawing no.	Order no.
M12 connector (according to EN 61076-2-101) · Output function OUT1: NO / NC progr. / IO-Link OUT2: analogue 4...20 mA / 0...10 V (invertible) · DC PNP/NPN · Wiring diagram no. 1 · Connector groups 8, 10, 19, 21, 23, 25, 148, 149, 153, 184, 188, 193, 202									
	264	195	53 / 16	18...30	0...35 / 35...65 ¹⁾	0...70	200	6	LK3122
	472	390	60 / 22	18...30	0...35 / 35...60 ¹⁾	0...70	200	6	LK3123
	728	585	104 / 39	18...30	0...35 / 35...55 ¹⁾	0...70	200	6	LK3124
M12 connector (according to EN 61076-2-101) · Output function OUT1: normally open / closed programmable / IO-Link OUT2: normally open / closed programmable · DC PNP/NPN · Wiring diagram no. 1 · Connector groups 8, 9, 10, 11, 18, 19, 21, 23, 25, 148, 149, 150, 151, 153, 154, 184, 188, 190, 193, 202, 203, 204									
	264	195	53 / 16	18...30	0...35 / 35...65 ¹⁾	0...70	200	6	LK1022
M12 connector (according to EN 61076-2-101) · Output function OUT1: normally open / closed progr. / IO-Link OUT2: normally open / closed progr. · DC PNP/NPN · Wiring diagram no. 1 · Connector groups 8, 10, 19, 21, 23, 25, 148, 149, 153, 184, 188, 193, 202									
	472	390	60 / 22	18...30	0...35 / 35...60 ¹⁾	0...70	200	6	LK1023
M12 connector (according to EN 61076-2-101) · Output function OUT1: normally open / closed programmable / IO-Link OUT2: normally open / closed programmable · DC PNP/NPN · Wiring diagram no. 1 · Connector groups 8, 9, 10, 11, 18, 19, 21, 23, 25, 148, 149, 150, 151, 153, 154, 184, 188, 190, 193, 202, 203, 204									
	728	585	104 / 39	18...30	0...35 / 35...55 ¹⁾	0...70	200	6	LK1024
M12 connector · Output function 2 x normally open / closed programmable · DC PNP · Wiring diagram no. 3 · Connector groups 8, 9, 10, 11, 18, 19, 21, 23, 25, 148, 149, 150, 151, 153, 154, 184, 188, 190, 193, 202, 203, 204									
	264	195	53 / 15	12...30	–	0...65	200	5	LK7022
	472	390	53 / 30	12...30	0...60	0...65	200	5	LK7023
	728	585	102 / 40	12...30	0...55	0...65	200	5	LK7024
M12 connector (according to EN 61076-2-101) · Output function OUT1: NO / NC programmable / IO-Link OUT2...4: NO/NC programmable · DC PNP/NPN · Connector groups 16, 17									
	264	195	53 / 16	18...30	0...35 / 35...65 ¹⁾	0...70	200	6	LK8122
	472	390	60 / 22	18...30	0...3 / 35...60 ¹⁾	0...70	200	6	LK8123
	728	585	104 / 39	18...30	0...35 / 35...55 ¹⁾	0...70	200	6	LK8124



Process sensors

Point level sensors for oils and coolants, approval to the German Federal Water Act (WHG), section 19







Type	Probe length [mm]	Output	U _b [V]	Medium temperature water [°C]	Medium temperature oil [°C]	I _{load} [mA]	Draw- ing no.	Order no.
	132	Normally closed	10...36	0...35	0...65	200	7	LI2141
	273	Normally closed	10...36	0...35	0...65	200	7	LI2142
	481	Normally closed	10...36	0...35	0...65	200	7	LI2143
	132	Normally closed	10...36	0...35	0...65	200	7	LI2241
	273	Normally closed	10...36	0...35	0...65	200	7	LI2242
	481	Normally closed	10...36	0...35	0...65	200	7	LI2243

Point level sensors for oils and lubricants





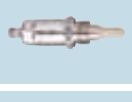

Type	Probe length [mm]	Output	U _b [V]	Medium temperature water [°C]	Medium temperature oil [°C]	I _{load} [mA]	Draw- ing no.	Order no.
	132	normally open / closed programmable	10...36	0...35 (LI5141 + E43103: 0...65)	0...65	200	7	LI5141
	273	normally open / closed programmable	10...36	0...35 (LI5142 + E43100: 0...65)	0...65	200	7	LI5142
	481	normally open / closed programmable	10...36	0...35 (LI5143 + E43101: 0...60)	0...65	200	7	LI5143
	737	normally open / closed programmable	10...36	0...35 (LI5144 + E43102: 0...55)	0...65	200	7	LI5144

M12 connector · Output function / · DC PNP · Wiring diagram no. 4 · Connector groups 8, 10, 11, 18, 19, 21, 23, 25, 148, 149, 150, 153, 154, 184, 188, 190, 193, 202, 203, 204

Point level sensors for oils and coolants, approval to the German Federal Water Act (WHG), section 19

Type	Process connection	Output	U _b [V]	Medium temperature water [°C]	Medium temperature oil [°C]	I _{load} [mA]	Drawing no.	Order no.
	G ½ A	1 x NO / 1 x NC (WHG) PNP	18...30	-40...85 / 0...85	-40...100 / 0...100	100	8	LMT191
	G ½ A	1 x NO / 1 x NC (WHG) PNP	18...30	-25...85 / 0...85	-25...100 / 0...100	100	9	LMT192
	G ½ A	1 x NO / 1 x NC (WHG) PNP	18...30	-25...85 / 0...85	-25...100 / 0...100	100	10	LMT194
	G ½ A	1 x NO / 1 x NC (WHG) PNP	18...30	-25...85 / 0...85	-25...100 / 0...100	100	11	LMT195
	G ¾ A	1 x NO / 1 x NC (WHG) PNP	18...30	-25...85 / 0...85	-25...100 / 0...100	100	12	LMT292
	G 1 A	1 x NO / 1 x NC (WHG) PNP	18...30	-25...85 / 0...85	-25...100 / 0...100	100	13	LMT392

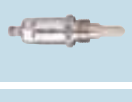
Point level sensors for hygienic areas

Type	Process connection	Output	U _b [V]	Medium temperature [°C]	I _{load} [mA]	Drawing no.	Order no.
	G ½ A	2 x normally open / closed programmable PNP/NPN	18...30	-40...100	100	8	LMT100
	G ½ A	2 x normally open / closed programmable PNP/NPN	18...30	-20...100	100	9	LMT102
	G ½ A	2 x normally open / closed programmable PNP/NPN	18...30	-20...100	100	10	LMT104
	G ½ A	2 x normally open / closed programmable PNP/NPN	18...30	-20...100	100	11	LMT105
	G ¾ A	2 x normally open / closed programmable PNP/NPN	18...30	-20...100	100	12	LMT202
	G 1 A	2 x normally open / closed programmable PNP/NPN	18...30	-20...100	100	13	LMT302



Process sensors

Type	Process connection	Output	U _b [V]	Medium temperature [°C]	I _{load} [mA]	Drawing no.	Order no.
------	--------------------	--------	-----------------------	----------------------------	---------------------------	-------------	-----------

M12 connector · Application oils, oil-based media · Wiring diagram no. 1 · Connector groups 8, 9, 10, 11, 18, 19, 21, 23, 25, 148, 149, 150, 151, 153, 154, 184, 188, 190, 193, 202, 203, 204

	G ½ A	2 x normally open / closed programmable PNP/NPN	18...30	-40...100	100	8	LMT110
---	-------	---	---------	-----------	-----	---	--------

M12 connector · Application Media with low water content · Wiring diagram no. 1 · Connector groups 8, 9, 10, 11, 18, 19, 21, 23, 25, 148, 149, 150, 151, 153, 154, 184, 188, 190, 193, 202, 203, 204

	G ½ A	2 x normally open / closed programmable PNP/NPN	18...30	-40...100	100	8	LMT121
---	-------	---	---------	-----------	-----	---	--------

Point level sensors for the hazardous areas

Type	Process connection	Output	U _b [V]	Medium temperature [°C]	I _{load} [mA]	Drawing no.	Order no.
------	--------------------	--------	-----------------------	----------------------------	---------------------------	-------------	-----------

M12 connector · Application oils, oil-based media, powders · Wiring diagram no. 1 · Connector groups 196, 198

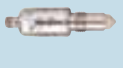
	G ½ A	2 x normally open / closed programmable PNP/NPN	18...30	-20...85	100	8	LMT01A
---	-------	---	---------	----------	-----	---	--------

	G ½ A	2 x normally open / closed programmable PNP/NPN	18...30	-20...85	100	10	LMT03A
---	-------	---	---------	----------	-----	----	--------

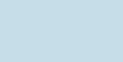
	G ½ A	2 x normally open / closed programmable PNP/NPN	18...30	-20...85	100	11	LMT04A
---	-------	---	---------	----------	-----	----	--------

Variable level sensors, guided wave radar, hygienic areas

Type	Process connection	Probe length [mm]	Active zone [mm]	Inactive zone [mm]	U _b [V]	Medium temperature [°C]	I _{load} [mA]	Drawing no.	Order no.
------	--------------------	----------------------	---------------------	-----------------------	-----------------------	----------------------------	---------------------------	-------------	-----------

M12 connector (according to EN 61076-2-101) · Output function OUT1: normally open / closed programmable / IO-Link OUT2: normally open / closed programmable or analogue (4...20 mA scaleable, invertable) · DC PNP/NPN · Wiring diagram no. 1 · Connector groups 8, 10, 19, 21, 23, 25, 148, 149, 153, 184, 188, 193, 202

	Aseptoflex Vario	150...2000	L-40	30 / 10	18...30	-40...150	150	14	LR2750
---	------------------	------------	------	---------	---------	-----------	-----	----	--------

Variable level sensors, guided wave radar, industrial applications

Type	Process connection	Probe length [mm]	Active zone [mm]	Inactive zone [mm]	U _b [V]	Medium temperature [°C]	I _{load} [mA]	Drawing no.	Order no.
------	--------------------	----------------------	---------------------	-----------------------	-----------------------	----------------------------	---------------------------	-------------	-----------

M12 connector (according to EN 61076-2-101) · Output function OUT1: normally open / closed programmable / IO-Link OUT2: normally open / closed programmable or analogue (4...20 mA scaleable, invertable) · DC PNP/NPN · Wiring diagram no. 1 · Connector groups 8, 10, 19, 21, 23, 25, 148, 149, 153, 184, 188, 193, 202

	G ¾ A	150...2000	L-40 / (L-60)	30 / 10 (30)	18...30	-20...100	150	15	LR2050
---	-------	------------	---------------	--------------	---------	-----------	-----	----	--------

Type	Process connection	Probe length [mm]	Active zone [mm]	Inactive zone [mm]	U _b [V]	Medium temperature [°C]	I _{load} [mA]	Draw- ing no.	Order no.
------	--------------------	----------------------	---------------------	-----------------------	-----------------------	----------------------------	---------------------------	---------------------	--------------

M12 connector (according to EN 61076-2-101) · Output function OUT1: normally open / closed programmable / IO-Link OUT2: normally open / closed programmable or analogue (4...20 mA scalable, invertable) · DC PNP/NPN · Wiring diagram no. 1 · Connector groups 8, 10, 19, 21, 23, 25, 148, 149, 153, 184, 188, 193, 202

	3/4" NPT	150...2000	L-40	30 / 10	18...30	-20...100	150	16	LR2350
---	----------	------------	------	---------	---------	-----------	-----	----	--------

M12 connector (according to EN 61076-2-101) · Output function normally open / closed programmable; 4...20 mA or 0...10 V · DC PNP · Wiring diagram no. 6 · Connector groups 8, 10, 19, 21, 23, 25, 148, 149, 153, 184, 188, 193, 202

	G ¾ A	100...1600	L-40 (L-60)	30 / 10 (30)	18...30	0...80	200	17	LR3000
---	-------	------------	-------------	--------------	---------	--------	-----	----	--------

	3/4" NPT	100...1600	L-40	30 / 10	18...30	0...80	200	18	LR3300
---	----------	------------	------	---------	---------	--------	-----	----	--------

M12 connector (according to EN 61076-2-101) · Output function 2 x normally open / closed programmable · DC PNP · Wiring diagram no. 6 · Connector groups 8, 10, 19, 21, 23, 25, 148, 149, 153, 184, 188, 193, 202

	G ¾ A	100...1600	L-40 (L-60)	30 / 10 (30)	18...30	0...80	200	17	LR7000
---	-------	------------	-------------	--------------	---------	--------	-----	----	--------

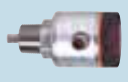
	3/4" NPT	100...1600	L-40	30 / 10	18...30	0...80	200	18	LR7300
--	----------	------------	------	---------	---------	--------	-----	----	--------

M12 connector (according to EN 61076-2-101) · Output function 4 x normally open / closed programmable · DC PNP · Connector groups 16, 17

	G ¾ A	100...1600	L-40 (L-60)	30 / 10 (30)	18...30	0...80	200	19	LR8000
---	-------	------------	-------------	--------------	---------	--------	-----	----	--------

	3/4" NPT	100...1600	L-40	30 / 10	18...30	0...80	200	20	LR8300
---	----------	------------	------	---------	---------	--------	-----	----	--------

M12 connector (according to EN 61076-2-101) · DC · Wiring diagram no. 1 · Connector groups 8, 10, 19, 21, 23, 25, 148, 149, 153, 184, 188, 193, 202

	G ¾ A	100...1600	L-40 (L-60)	30 / 10 (30)	18...30	0...80	–	21	LR9020
---	-------	------------	-------------	--------------	---------	--------	---	----	--------

Compact sensors for level and temperature monitoring

Type	Probe length [mm]	Active zone [mm]	Inactive zone [mm]	U _b [V]	Medium temperature water [°C]	Medium temperature oil [°C]	I _{load} [mA]	Draw- ing no.	Order no.
------	----------------------	---------------------	-----------------------	-----------------------	----------------------------------	--------------------------------	---------------------------	---------------------	--------------

M12 connector (according to EN 61076-2-101) · Output function OUT1: normally open / closed programmable / IO-Link OUT2: analog 0...20 mA / 0...10 V (invertable; scaleable analogue signal for temperature) · DC PNP/NPN · Wiring diagram no. 1 · Connector groups 8, 10, 19, 21, 23, 25, 148, 149, 153, 184, 188, 193, 202



	264	195	53 / 16	18...30	0...35 / 35...65 ¹⁾	0...70	200	22	LT3022
---	-----	-----	---------	---------	--------------------------------	--------	-----	----	--------

	472	390	60 / 22	18...30	0...35 / 35...60 ¹⁾	0...70	200	22	LT3023
---	-----	-----	---------	---------	--------------------------------	--------	-----	----	--------

	728	585	104 / 39	18...30	0...35 / 35...55 ¹⁾	0...70	200	22	LT3024
---	-----	-----	----------	---------	--------------------------------	--------	-----	----	--------

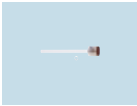

Process sensors

Type	Probe length [mm]	Active zone [mm]	Inactive zone [mm]	U _b [V]	Medium temperature water [°C]	Medium temperature oil [°C]	I _{load} [mA]	Drawing no.	Order no.
M12 connector (according to EN 61076-2-101) · Output function OUT1: NO / NC programmable / IO-Link OUT2...4: NO/NC programmable · DC PNP/NPN · Connector groups 16, 17									
	264	195	53 / 16	18...30	0...35 / 35...65 ¹⁾	0...70	200	22	LT8022
	472	390	60 / 22	18...30	0...35 / 35...60 ¹⁾	0...70	200	22	LT8023
	728	585	104 / 39	18...30	0...35 / 35...55 ¹⁾	0...70	200	22	LT8024

Sensors for hydrostatic level monitoring

Type	Measuring range [bar]	Cable length / material	P _{overload} max. [bar]	P _{bursting} min. [bar]	U _b DC [V]	Drawing no.	Order no.
Output function 4...20 mA analogue · Wiring diagram no. 7							
	0...0.25	5 m PUR cable	2	2.4	10...30	23	PS3208
	0...0.6	10 m PUR cable	4	4.8	10...30	23	PS3407
	0...0.6	15 m PUR cable	4	4.8	10...30	23	PS3427
	0...1	15 m PUR cable	5	6	10...30	23	PS3417
	0...0.6	30 m PUR cable	4	4.8	10...30	23	PS3607
	0...1	30 m PUR cable	5	6	10...30	23	PS3617

Output function 4...20 mA analogue · Wiring diagram no. 8



	0...0.25	5 m FEP cable	2	2.4	10...30	24	PS4208
	0...0.6	10 m FEP cable	3	4	10...30	24	PS4407

Wiring diagram no. 8

	0...1	15 m FEP cable	5	6	10...30	24	PS4417
---	-------	-------------------	---	---	---------	----	---------------

Type	Measuring range [bar]	Cable length / material	P _{overload} max. [bar]	P _{bursting} min. [bar]	U _b DC [V]	Draw- ing no.	Order no.
------	--------------------------	-------------------------	-------------------------------------	-------------------------------------	-----------------------------	---------------------	--------------

Output function 4...20 mA · Wiring diagram no. 9 · Connector groups 8, 10, 19, 21, 23, 25, 148, 149, 153, 184, 188, 193, 202

	0...0.25	M12 connector	10	30	9.6...32	25	PA3028
	0...0.25	M12 connector	10	30	9.6...32	26	PA3528

Output function 4...20 mA · Wiring diagram no. 10 · Connector groups 8, 10, 19, 21, 23, 25, 148, 149, 153, 184, 188, 193, 202

	0...0.1	M12 connector	4	30	9.6...32	26	PA3589
---	---------	---------------	---	----	----------	----	--------

Sensors for hydrostatic level monitoring ATEX category 1G/1D

Type	Measuring range [bar]	Cable length / material	P _{overload} max. [bar]	P _{bursting} min. [bar]	U _b DC [V]	Draw- ing no.	Order no.
------	--------------------------	-------------------------	-------------------------------------	-------------------------------------	-----------------------------	---------------------	--------------

Output function 4...20 mA analogue · Wiring diagram no. 8

	0...0.25	5 m FEP cable	2	2.4	10...30	24	PS308A
	0...0.6	10 m FEP cable	4	4.8	10...30	24	PS307A
	0...1	15 m FEP cable	5	6	10...30	24	PS317A

Sensors for hydrostatic level monitoring in hygienic and wet areas







Type	Process connection	Display	Measuring range [bar]	P _{overload} max. [bar]	P _{bursting} min. [bar]	U _b DC [V]	Draw- ing no.	Order no.
------	--------------------	---------	--------------------------	-------------------------------------	-------------------------------------	-----------------------------	---------------------	--------------

M12 connector · Output function 1 x normally open / normally closed progr. + 1 x normally open / normally closed progr. or 1 x analogue (4...20 / 20...4 mA, scalable) · Wiring diagram no. 12 · Connector groups 8, 10, 19, 21, 23, 25, 148, 149, 153, 184, 188, 193, 202

	Aseptoflex Vario	Display unit	-0.005...0.1	4	30	20...32	27	PI2789
	Aseptoflex Vario	Display unit	-0.0124...0.25	10	30	20...32	27	PI2798
	Aseptoflex Vario	Display unit	-1...1	10	30	20...32	27	PI2799
	Aseptoflex Vario	Display unit	-0.05...1	10	30	20...32	27	PI2797



Process sensors

Type	Process connection	Display	Measuring range [bar]	P _{overload} max. [bar]	P _{bursting} min. [bar]	U _b DC [V]	Draw- ing no.	Order no.
M12 connector · Output function 1 x normally open / normally closed progr. + 1 x normally open / normally closed progr. or 1 x analogue (4...20 / 20...4 mA, scalable) · Wiring diagram no. 12 · Connector groups 8, 10, 19, 21, 23, 25, 148, 149, 153, 184, 188, 193, 202								
	Aseptoflex Vario	Display unit	-0.124...2.5	20	50	20...32	27	PI2796
	Sealing cone G1 male	Display unit	-0.005...0.1	4	30	20...32	28	PI2889*
	Sealing cone G1 male	Display unit	-0.124...2.5	20	50	20...32	28	PI2896*
	Sealing cone G1 male	Display unit	-0.05...1	10	30	20...32	28	PI2897*
	Sealing cone G1 male	Display unit	-0.0124...0.25	10	30	20...32	28	PI2898*
	Sealing cone G1 male	Display unit	-1...1	10	30	20...32	28	PI2899*
M12 connector · Output function 1 x normally open / normally closed progr. + 1 x normally open / normally closed progr. or 1 x analogue (4...20 / 20...4 mA, scalable) · Wiring diagram no. 13 · Connector groups 8, 10, 19, 21, 23, 25, 148, 149, 153, 184, 188, 193, 202								
	Clamp DN 38 / 1 1/2"	Display unit	-0.124...2.5	20	50	20...32	29	PI2206
	Clamp DN 38 / 1 1/2"	Display unit	-0.05...1	10	30	20...32	29	PI2207
	Clamp DN 38 / 1 1/2"	Display unit	-1...1	10	30	20...32	29	PI2209
M12 connector · Output function 1 x normally open / closed programmable + 1 x analogue (4...20 / 20...4 mA, scalable) · Wiring diagram no. 14 · Connector groups 8, 10, 19, 21, 23, 25, 148, 149, 153, 184, 188, 193, 202								
	Aseptoflex Vario	Display unit	-0.005...0.1	4	30	18...32	30	PG2789
	Aseptoflex Vario	Display unit	-0.0124...0.25	10	30	18...32	30	PG2798
	Aseptoflex Vario	Display unit	-0.05...1	10	30	18...32	30	PG2797
	Aseptoflex Vario	Display unit	-1...1	10	30	18...32	30	PG2799
	Aseptoflex Vario	Display unit	-0.124...2.5	20	50	18...32	30	PG2796









Type	Process connection	Display	Measuring range [bar]	P _{overload} max. [bar]	P _{bursting} min. [bar]	U _b DC [V]	Draw- ing no.	Order no.
------	--------------------	---------	--------------------------	-------------------------------------	-------------------------------------	-----------------------------	---------------------	--------------

M12 connector · Output function 1 x normally open / closed programmable + 1 x analogue (4...20 / 20...4 mA, scalable) · Wiring diagram no. 14 · Connector groups 8, 10, 19, 21, 23, 25, 148, 149, 153, 184, 188, 193, 202

	Sealing cone G1 male	Display unit	-0.124...2.5	20	50	18...32	31	PG2896*
	Sealing cone G1 male	Display unit	-0.05...1	10	30	18...32	31	PG2897*
	Sealing cone G1 male	Display unit	-0.0124...0.25	10	30	18...32	31	PG2898*
	Sealing cone G1 male	Display unit	-1...1	10	30	18...32	31	PG2899*
	Sealing cone G1 male	Display unit	-0.005...0.1	4	30	18...32	31	PG2889*

* Attention: The unit must only be installed in a process connection for G1 sealing cone! The G1 male sealing cone of the unit is only suited for adapters with metal end stop!

Accessories for level sensors LK, LT, LL, LI



Type	Description	Order no.
	Flange plate · 54-52X52 D16 · for capacitive level sensors LK, LI, LT, LL · Housing materials: flange: aluminium anodised / nut: stainless steel / Spacer: Brass / rubber ring: FPM / sealing: Tesnit	E43007
	Flange plate · 65-80 D16 · for capacitive level sensors LK, LI, LT, LL · Housing materials: flange: aluminium anodised / nut: stainless steel / Spacer: Brass / rubber ring: FPM	E43006
	Flange plate · 73-90 D16 · for capacitive level sensors LK, LI, LT, LL · according to DIN 24557 · Housing materials: aluminium anodised / nut: stainless steel / Spacer: Brass / rubber ring: FPM / sealing: NBR	E43001
	Mounting adapter · G 3/4 D16 · D16 · for capacitive level sensors LK, LI, LT, LL · Housing materials: flange: stainless steel / nut: stainless steel / Spacer: Brass / rubber ring: FPM / sealing: Tesnit	E43003
	Mounting adapter · G 3/4 D16 · D16 · for capacitive level sensors LI · Housing materials: Brass nickel-plated / TPE / sealing: FKM	E43019
	Mounting adapter · G 3/4 D22 · D22 · for climatic tube LK / LI · Housing materials: stainless steel / NBR / Tesnit / Brass	E43008
	Mounting adapter · 3/4" NPT D16 · D16 · for capacitive level sensors LK, LI, LT, LL · Housing materials: flange: stainless steel / nut: stainless steel / Spacer: Brass / rubber ring: FPM	E43012
	Mounting adapter · 3/4" NPT D22 · D22 · for climatic tube LK / LI · Housing materials: stainless steel / NBR / Brass	E43014



Process sensors

Type	Description	Order no.
	Mounting adapter · G 1 D16 · D16 · for capacitive level sensors LK, LI, LT, LL · Housing materials: flange: stainless steel / nut: stainless steel / Spacer: Brass / rubber ring: FPM / sealing: Tesnit	E43004
	Mounting adapter · G 1 D22 · D22 · for climatic tube LK / LI · Housing materials: stainless steel / NBR / Tesnit / Brass	E43009
	Mounting adapter · 1" NPT D16 · D16 · for capacitive level sensors LK, LI, LT, LL · Housing materials: flange: stainless steel / nut: stainless steel / Spacer: Brass / rubber ring: FPM	E43013
	Climatic tube · Length: 132 mm · for capacitive level sensors LK, LI · Housing materials: PPH / NBR	E43103
	Climatic tube · Length: 264 mm · for capacitive level sensors LK, LI · Housing materials: PPH / NBR	E43100
	Climatic tube · Length: 472 mm · for capacitive level sensors LK, LI · Housing materials: PPH / NBR	E43101
	Climatic tube · Length: 728 mm · for capacitive level sensors LK, LI · Housing materials: PPH / NBR	E43102
	Mounting clamp · Ø 16 mm · for capacitive level sensors LK, LI, LT, LL · Housing materials: PP	E43000
	Mounting set · Ø 16 mm · for capacitive level sensors LK, LI, LT, LL · Housing materials: PP / Metal parts: steel galvanised	E43016
	Welding adapter · Ø 50 D16 · D16 · for capacitive level sensors LK, LI, LT, LL · Housing materials: flange: stainless steel / nut: stainless steel / Spacer: Brass / rubber ring: FPM	E43002
	Protective cover · for LK / LL / LR / LT sensors · Housing materials: PP	E43910

Parameter-setting system

Type	Description	Order no.
	Memory plug · Parameter memory for IO-Link sensors · Storage capacity: 2 Kbytes · Housing materials: PA PACM 12 / PET / sealing: FPM / nut: stainless steel 316L / 1.4404 / connector: TPU	E30398
	USB IO-Link master · for parameter setting and analysis of units · Supported communication protocols: IO-Link (4.8, 38.4 and 230 Kbits/s) · for operation with FDT framework software "ifm Container" or software "LINERECORDER SENSOR"	E30390





Software

Type	Description	Order no.
	LR DEVICE (USB stick) · Parameter setting of the units via the network · Software for clear online and offline parameter setting of IO-Link sensors via USB adapter · Use via USB connection cable (drivers are supplied): E30396 IO-Link interface or E30390 IO-Link master (note the respective data sheet) · IODD import and update from ifm's homepage · Reading of IODDs via storage media · Automatic sensor identification · Graphic representation of the process values and history incl. export function · Documentation and archiving · Transferable parameter sets · Full memory plug support for IO-Link 1.1	QA0011
	LR DEVICE (download) · Parameter setting of the units via the network · Software for clear online and offline parameter setting of IO-Link sensors via USB adapter · Use via USB connection cable (drivers are supplied): E30396 IO-Link interface or E30390 IO-Link master (note the respective data sheet) · IODD import and update from ifm's homepage · Reading of IODDs via storage media · Automatic sensor identification · Graphic representation of the process values and history incl. export function · Documentation and archiving · Transferable parameter sets · Full memory plug support for IO-Link 1.1	QA0012

Certificates















Description	Order no.
Factory calibration certificate for pressure sensors and flow sensors · Measurement points, pressure sensors: 6 measurement points in 20% steps of the final value of the measuring range (acc. to ISO 9001) · Measurement points, flow sensors: 3 or 4 measurement points, distances defined depending on the measuring range (acc. to ISO 9001)	ZC0004
DAkKS calibration certificate for pressure sensors · Number of measuring points: 11-point DAkKS calibration · Measurement points: in 10 % steps of the measuring range (according to directive DAkKS-DKD-R 6-1) · Minimum measurement uncertainty [bar]: 20 µbar...140 mbar (depending on the reference pressure)	ZC0005
Recalibration for LDP oil particle monitor · LDP100	ZC0069





Accessories for LMT level sensors

Type	Description	Order no.
	Clamp adapter · Clamp · 1-1.5" · ISO 2852 / DIN 32676 · for units with G ½ adaptation · Housing materials: stainless steel 316L / 1.4404	E33401
	Clamp adapter · Clamp · 2" · ISO 2852 / DIN 32676 · for units with G ½ adaptation · Housing materials: stainless steel 316L / 1.4404	E33402
	Welding adapter · G ½ - Ø 26.4 mm · Housing materials: High-grade stainless steel 316Ti / 1.4571	E43375
	Welding adapter · G ½ - Ø 29 mm · for pipes · Housing materials: stainless steel 316L / 1.4435	E43301
	Welding adapter · G ½ - Ø 30 mm · for tanks · Housing materials: stainless steel 316L / 1.4435	E43300
	Welding adapter · G ½ - Ø 35 mm · Housing materials: stainless steel 316L / 1.4404	E30055







Process sensors

Type	Description	Order no.
	Welding adapter · G ½ - Ø 45 mm · Housing materials: stainless steel 316L / 1.4404	E30056
	Adapter · G ¾ · Housing materials: stainless steel 316L / 1.4435	E43302
	Adapter · G 1 · Housing materials: stainless steel 316L / 1.4435	E43303
	Adapter · ¾" NPT · Housing materials: stainless steel 316L / 1.4404	E43313
	Pipe fitting · G ½ · Hygienic pipe fitting · DN25 (1") · DIN 11851 · Housing materials: stainless steel 316L / 1.4435	E43304
	Pipe fitting · G ½ · Hygienic pipe fitting · DN40 (1.5") · DIN 11851 · Housing materials: stainless steel 316L / 1.4435	E43305
	Clamp adapter · G ½ · Varivent type F · DN25 (1"), D = 50 · Housing materials: stainless steel 316L / 1.4435	E43306
	Clamp adapter · G ½ · Varivent type N · DN40...DN150 (1.5...6"), D = 68 · Housing materials: stainless steel 316L / 1.4435	E43307
	Welding mandrel · G ½ · carries away heat during welding · Housing materials: CW614N	E43314
	T-piece · G ½ I - DN25 · for sensors and adapters with process connection G ½ A · Housing materials: stainless steel	E43316
	T-piece · G ½ I - DN40 · for sensors and adapters with process connection G ½ A · Housing materials: stainless steel	E43317
	T-piece · G ½ I - DN50 · for sensors and adapters with process connection G ½ A · Housing materials: stainless steel	E43318
	Sealing ring · Ø 26.5 mm x Ø 21.3 mm x 1.5 mm · Housing materials: NBR fibre-reinforced	E43376
	Pipe fitting · SMS pipe fitting · DN25 · SMS · for units with G ½ adaptation · Housing materials: stainless steel 316L / 1.4404	E33430
	sealing plug · G ½ · Housing materials: stainless steel 316L / 1.4435	E43308

Type	Description	Order no.
	Welding adapter · G ½ · Ø 30 mm · for tanks · with leakage port · with leakage port · Housing materials: stainless steel 316L / 1.4435	E43309
	Welding adapter · G ½ · Ø 29 mm · for pipes · with leakage port · with leakage port · Housing materials: stainless steel 316L / 1.4435	E43310
	Welding adapter · G ½ · with leakage port · Housing materials: stainless steel 316L / 1.4404	E43315
	Clamp adapter · G ½ · with leakage port · Clamp · 1-1.5" · ISO 2852 / DIN 32676 · with leakage port · Housing materials: stainless steel 316L / 1.4435	E43311
	Clamp adapter · G ½ · with leakage port · Clamp · 2" · ISO 2852 / DIN 32676 · with leakage port · Housing materials: stainless steel 316L / 1.4435	E43312

Accessories for LMC level sensors



Type	Description	Order no.
	Welding mandrel · G ½ male · for G ½ adapter · carries away heat during welding · For installation via back thread · for non-hygienic adapters only · Alignment aid for welding an adapter · Housing materials: CW614N	E43382
	Mounting set · Ø 26.9 mm · for type LMC4x0 · Housing materials: PP / Metal parts: steel galvanised	E43384
	cover · Ø 28 mm x 50 mm · Housing materials: PVC	E43385
	Adapter · G1 male · Suited for installation in existing tuning fork adapters · Housing materials: adapter: stainless steel / cover: PVC	E43383

Accessories for level sensors LR

Type	Description	Order no.
	Flange plate · 65-80 / G ¾ · for level sensors LR · Housing materials: flange: stainless steel	E43202
	Flange plate · 73-90 / G ¾ · for level sensors LR · according to DIN 24557 · Housing materials: flange: stainless steel / sealing: NBR	E43201
	Flange plate · 73-90 / ¾" NPT · for level sensors LR · according to DIN 24557 · Housing materials: flange: stainless steel / sealing: NBR	E43206



Process sensors

Type	Description	Order no.
	Welding adapter · G 3/4 · Ø 31.8 mm · Housing materials: High-grade stainless steel 316Ti / 1.4571	E43379
	Launching plate · G 3/4 · for level sensors LR · Housing materials: High-grade stainless steel 316Ti / 1.4571	E43380
	Launching plate · 3/4" NPT · for level sensors LR · Housing materials: base plate: High-grade stainless steel 316Ti / 1.4571 / adapter: stainless steel	E43381

LR probes for standard applications

Type	Description	Order no.
	Probe · Probe length: 150 mm · for level sensors LR · Housing materials: stainless steel 316L / 1.4404	E43225
	Probe · Probe length: 210 mm · for level sensors LR · Housing materials: stainless steel	E43351
	Probe · Probe length: 240 mm · for level sensors LR · Housing materials: stainless steel 316L / 1.4404	E43203
	Probe · Probe length: 265 mm · for level sensors LR · Housing materials: stainless steel	E43352
	Probe · Probe length: 300 mm · for level sensors LR · Housing materials: stainless steel 316L / 1.4404	E43226
	Probe · Probe length: 450 mm · for level sensors LR · Housing materials: stainless steel 316L / 1.4404	E43204
	Probe · Probe length: 500 mm · for level sensors LR · Housing materials: stainless steel 316L / 1.4404	E43227
	Probe · Probe length: 700 mm · for level sensors LR · Housing materials: stainless steel 316L / 1.4404	E43205
	Probe · Probe length: 800 mm · for level sensors LR · Housing materials: stainless steel	E43337
	Probe · Probe length: 1000 mm · for level sensors LR · Housing materials: stainless steel 316L / 1.4404	E43207
	Probe · Probe length: 1200 mm · for level sensors LR · Housing materials: stainless steel 316L / 1.4404	E43208

Type	Description	Order no.
	Probe · Probe length: 1400 mm · for level sensors LR · Housing materials: stainless steel 316L / 1.4404	E43209
	Probe · Probe length: 1600 mm · for level sensors LR · Housing materials: stainless steel 316L / 1.4404	E43210
	Probe · Probe length: 2000 mm · for level sensors LR · Housing materials: stainless steel	E43353

LR probes for hygienic areas



Type	Description	Order no.
	Probe · Probe length: 150 mm · hygienic, for LR level sensors · hygienic systems · Housing materials: stainless steel	E43345
	Probe · Probe length: 300 mm · hygienic, for LR level sensors · hygienic systems · Housing materials: stainless steel	E43346
	Probe · Probe length: 500 mm · hygienic, for LR level sensors · hygienic systems · Housing materials: stainless steel	E43340
	Probe · Probe length: 700 mm · hygienic, for LR level sensors · hygienic systems · Housing materials: stainless steel	E43347
	Probe · Probe length: 1000 mm · hygienic, for LR level sensors · hygienic systems · Housing materials: stainless steel	E43341
	Probe · Probe length: 1500 mm · hygienic, for LR level sensors · hygienic systems · Housing materials: stainless steel	E43348
	Probe · Probe length: 2000 mm · hygienic, for LR level sensors · hygienic systems · Housing materials: stainless steel	E43342

LR coaxial pipes

Type	Description	Order no.
	Coaxial pipe · Length: 150 mm · G 3/4 · for level sensors LR · Housing materials: stainless steel / sealing: Tesnit	E43230
	Coaxial pipe · Length: 210 mm · G 3/4 · for level sensors LR · Housing materials: Coaxial pipe: 304 / 1.4301 / fixing bracket: 301 / 1.4310 / centring piece: PP GF30 / Seal: aramid 20 / NBR80:	E43354



Process sensors

Type	Description	Order no.	
	Coaxial pipe · Length: 240 mm · G 3/4 · for level sensors LR · Housing materials: stainless steel / sealing: Tesnit / centring piece: PP / fixing bracket: stainless steel	E43211	
	Coaxial pipe · Length: 265 mm · G 3/4 · for level sensors LR · Housing materials: Coaxial pipe: 304 / 1.4301 / fixing bracket: 301 / 1.4310 / centring piece: PP GF30 / Seal: aramid 20 / NBR80:	E43355	
	Coaxial pipe · Length: 300 mm · G 3/4 · for level sensors LR · Housing materials: stainless steel / sealing: NBR / centring piece: PP / fixing bracket: stainless steel	E43228	
	Coaxial pipe · Length: 450 mm · G 3/4 · for level sensors LR · Housing materials: 304 / 1.4301 / sealing: Tesnit / centring piece: PPS reinforced glass-fibre / fixing bracket: 301 / 1.4310	E43212	
	Coaxial pipe · Length: 500 mm · G 3/4 · for level sensors LR · Housing materials: stainless steel / sealing: Tesnit / centring piece: PP / fixing bracket: stainless steel	E43229	
	Coaxial pipe · Length: 700 mm · G 3/4 · for level sensors LR · Housing materials: stainless steel / sealing: Tesnit / centring piece: PP / fixing bracket: stainless steel	E43213	
	Coaxial pipe · Length: 800 mm · G 3/4 · for level sensors LR · Housing materials: Coaxial pipe: 304 / 1.4301 / fixing bracket: 301 / 1.4310 / centring piece: PP GF30 / Seal: aramid 20 / NBR80:	E43336	
	Coaxial pipe · Length: 1000 mm · G 3/4 · for level sensors LR · Housing materials: stainless steel / sealing: Tesnit / centring piece: PP / fixing bracket: stainless steel	E43214	
	Coaxial pipe · Length: 1200 mm · G 3/4 · for level sensors LR · Housing materials: stainless steel / sealing: Tesnit / centring piece: PP / fixing bracket: stainless steel	E43215	
	Coaxial pipe · Length: 1400 mm · G 3/4 · for level sensors LR · Housing materials: stainless steel / sealing: Tesnit / centring piece: PP / fixing bracket: stainless steel	E43216	
	Coaxial pipe · Length: 1600 mm · G 3/4 · for level sensors LR · Housing materials: stainless steel / sealing: Tesnit / centring piece: PP / fixing bracket: stainless steel	E43217	
	Coaxial pipe · Length: 2000 mm · G 3/4 · for level sensors LR205X · Housing materials: Coaxial pipe: 304 / 1.4301 / fixing bracket: 301 / 1.4310 / centring piece: PP GF30 / Seal: aramid 20 / NBR80:	E43356	
		Coaxial pipe · Length: 240 mm · 3/4" NPT · for level sensors LR · Housing materials: 304 / 1.4301 / centring piece: PPS fibre-reinforced / fixing bracket: 301 / 1.4310	E43377
		Coaxial pipe · Length: 450 mm · 3/4" NPT · for level sensors LR · Housing materials: stainless steel / centring piece: PP / fixing bracket: stainless steel	E43218
Coaxial pipe · Length: 700 mm · 3/4" NPT · for level sensors LR · Housing materials: stainless steel / centring piece: PP / fixing bracket: stainless steel		E43219	
Coaxial pipe · Length: 1000 mm · 3/4" NPT · for level sensors LR · Housing materials: stainless steel / centring piece: PP / fixing bracket: stainless steel		E43220	

Type	Description	Order no.
	Coaxial pipe · Length: 1200 mm · ¾" NPT · for level sensors LR · Housing materials: stainless steel / centring piece: PP / fixing bracket: stainless steel	E43223
	Coaxial pipe · Length: 1400 mm · ¾" NPT · for level sensors LR · Housing materials: stainless steel / centring piece: PP / fixing bracket: stainless steel	E43224
	Coaxial pipe · Length: 1600 mm · ¾" NPT · for level sensors LR · Housing materials: stainless steel / centring piece: PP / fixing bracket: stainless steel	E43221
	Coaxial pipe · Length: 2000 mm · ¾" NPT · for level sensors LR · Housing materials: 304 / 1.4301 / centring piece: PPS fibre-reinforced / fixing bracket: 301 / 1.4310	E43378
	Coaxial pipe · Length: 700 mm · G ¾ · for level sensors LR · Housing materials: stainless steel / sealing: NBR / centring piece: PP / fixing bracket: stainless steel	E43333
	Coaxial pipe · Length: 1200 mm · G ¾ · for level sensors LR · Housing materials: stainless steel / sealing: Tesnit / centring piece: PP / fixing bracket: stainless steel	E43334
	Coaxial pipe · Length: 450 mm · for level sensors LR · Housing materials: stainless steel / sealing: Tesnit / centring piece: PP / fixing bracket: stainless steel	E43320





Hygienic adapters

Type	Description	Order no.
	Welding adapter · Ø 50 mm · for units with Aseptoflex Vario adapter · Sealing by sealing ring · Housing materials: stainless steel 316L / 1.4435	E30122
	Pipe fitting · Hygienic pipe fitting · Hygienic pipe fitting · DN40 (1.5") · DIN 11851 · for units with Aseptoflex Vario adapter · Sealing by sealing ring · Housing materials: stainless steel 316L / 1.4435	E33212
	Pipe fitting · Hygienic pipe fitting · Hygienic pipe fitting · DN50 (2") · DIN 11851 · for units with Aseptoflex Vario adapter · Sealing by sealing ring · Housing materials: stainless steel 316L / 1.4435	E33213
	Pipe fitting · Hygienic pipe fitting · Hygienic pipe fitting · DN40 (1.5") · DIN 11851 · for units with Aseptoflex Vario adapter · Metal to metal seal · Housing materials: stainless steel 316L / 1.4435	E33712
	Pipe fitting · Hygienic pipe fitting · Hygienic pipe fitting · DN50 (2") · DIN 11851 · for units with Aseptoflex Vario adapter · Metal to metal seal · Housing materials: stainless steel 316L / 1.4435	E33713
	Clamp adapter · Clamp · 1-1.5" · ISO 2852 · for units with Aseptoflex Vario adapter · Sealing by sealing ring · Housing materials: stainless steel 316L / 1.4435	E33201
	Clamp adapter · Clamp · 1-1.5" · ISO 2852 · for units with Aseptoflex Vario adapter · Metal to metal seal · Housing materials: stainless steel 316L / 1.4435	E33701



Process sensors

Accessories for level sensors PA, PG, PI, PN, PS, PY

Type	Description	Order no.
	Cable clamp fastener · for submersible pressure transmitter PS3 · Housing materials: steel / plastics	E30399
	Filter element · for submersible pressure transmitter PS3 · for fixing on the capillary tube	E30400
	Splitter box · with ventilation and terminal block · for submersible pressure transmitter PS3 · Housing materials: plastics	E30401
	Additional weight · for submersible pressure transmitter PS3 · Housing materials: stainless steel 316Ti / 1.4571	E30402

Wiring diagrams

Core colours

BK	black
BN	brown
BU	blue
WH	white
GY	grey
GN	green

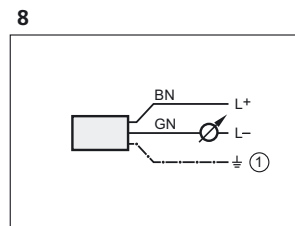
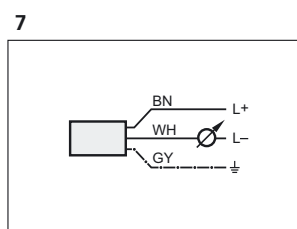
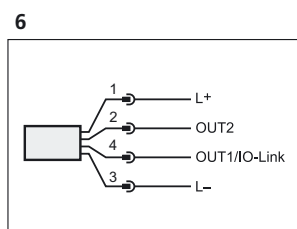
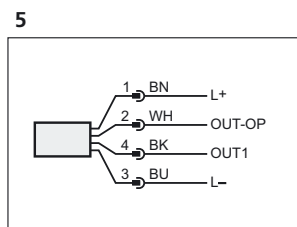
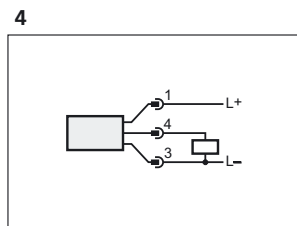
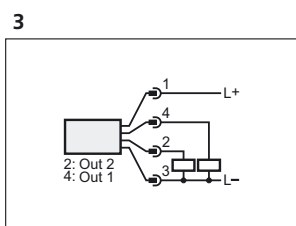
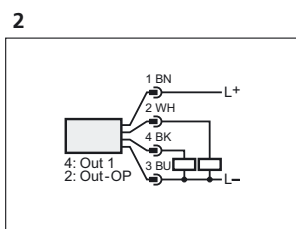
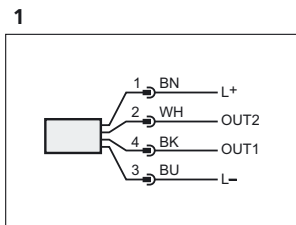

1: screen (connected to the housing)

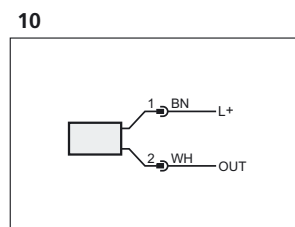
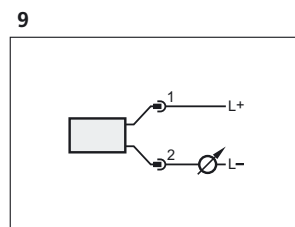

Wiring diagrams

11

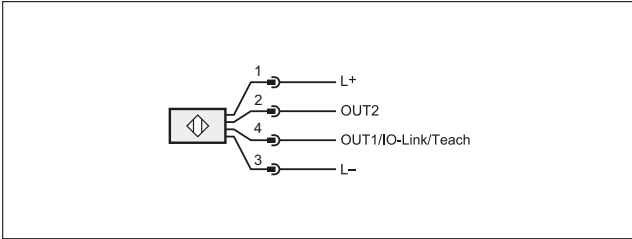

13

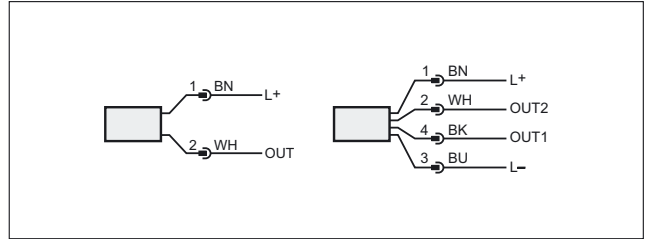

12

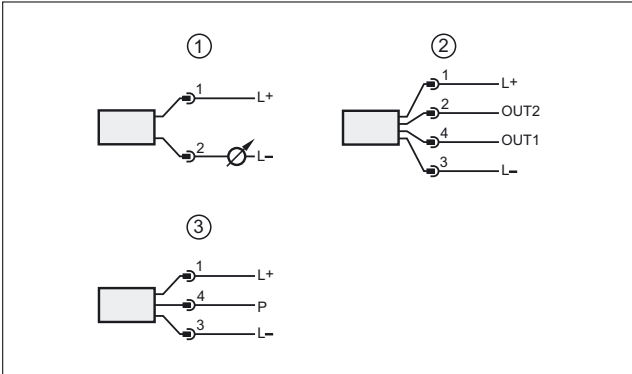

14

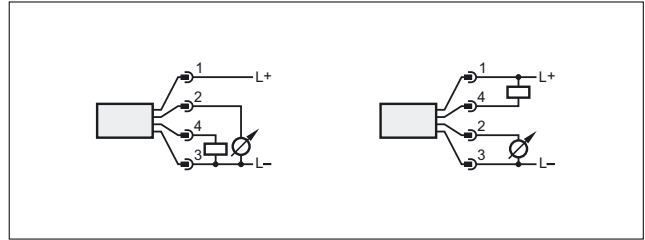

1: connection for 2-wire operation, 2: connection for 3-wire operation, 3: connection for IO-Link parameter setting (P = communication via IO-Link)

Scale drawings / drawing no. – CAD download: www.ifm.com

1

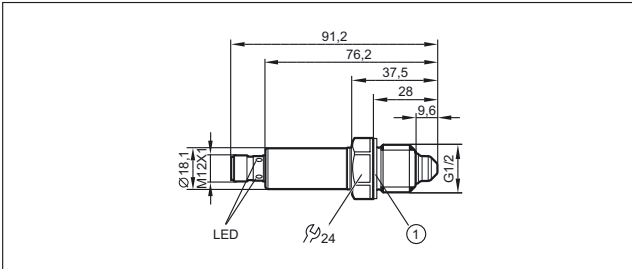

4

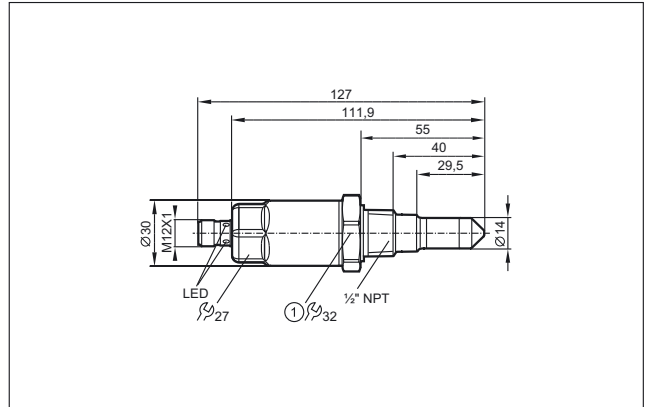

2

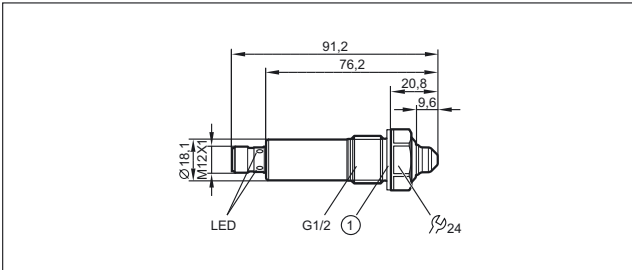

5

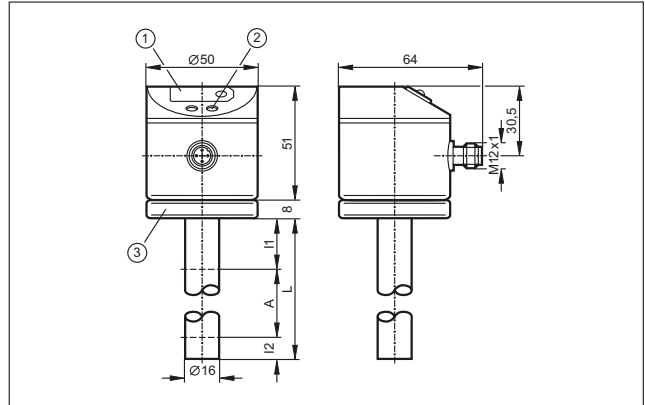

3

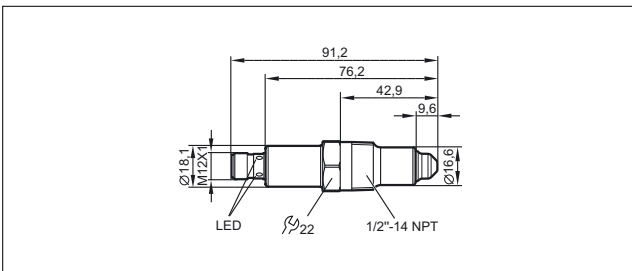

1: 7-segment LED display, 2: Programming buttons, 3: Housing connection with cable lug for cable 1.5 - 2.5 mm²



Process sensors

Scale drawings / drawing no. – CAD download: www.ifm.com

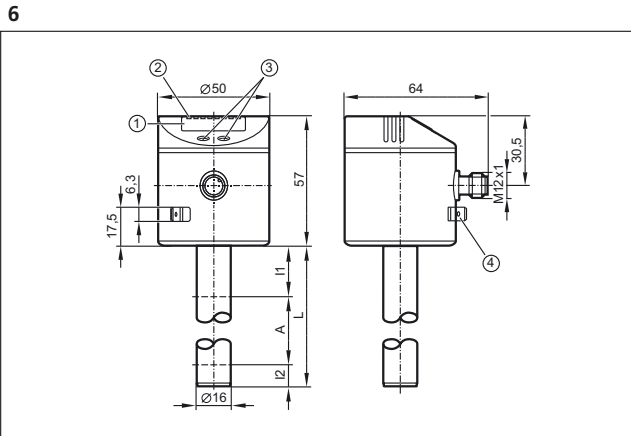

1: 4-digit alphanumeric display, 2: status LEDs, 3: Programming buttons, 4: Housing connection (flat-pin connector 6.3 mm following DIN 46244)

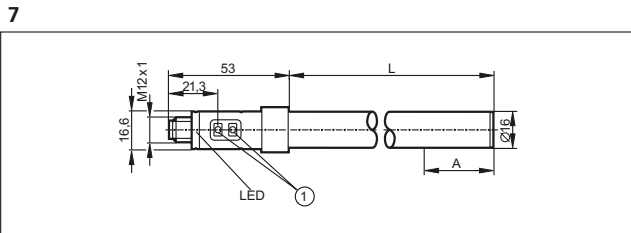

1: Programming buttons

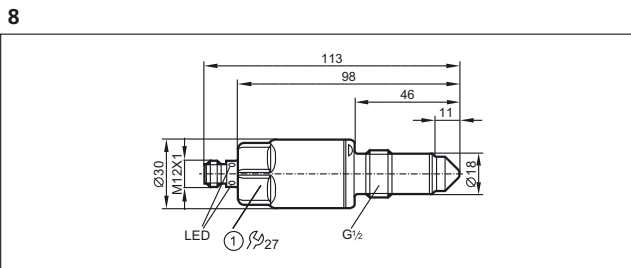

1: tightening torque 20...25 Nm

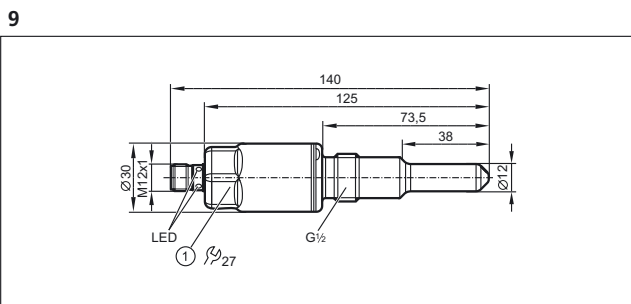

1: tightening torque 20...25 Nm

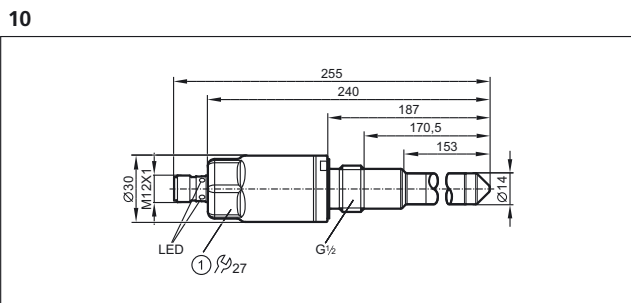

1: tightening torque 20...25 Nm

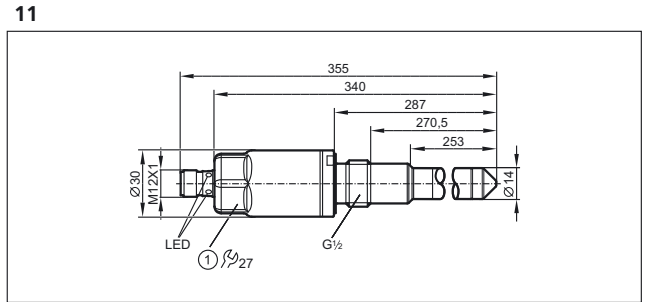

1: tightening torque 20...25 Nm

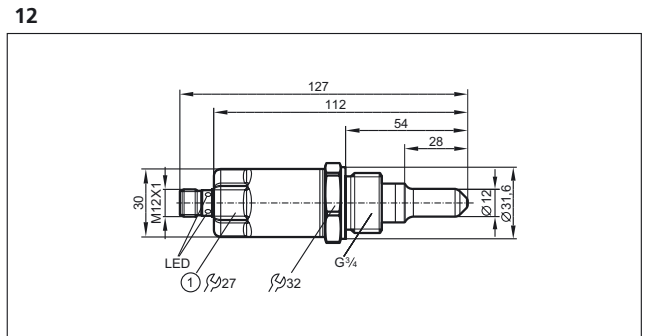

1: tightening torque 35 Nm

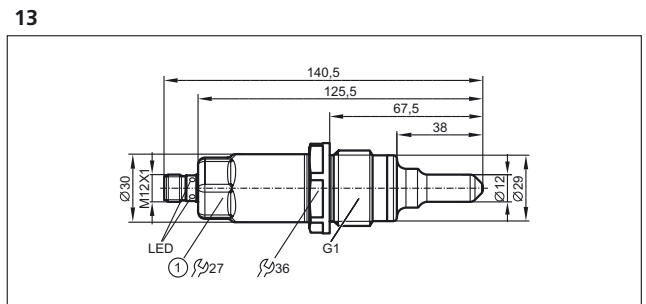

1: tightening torque 35 Nm

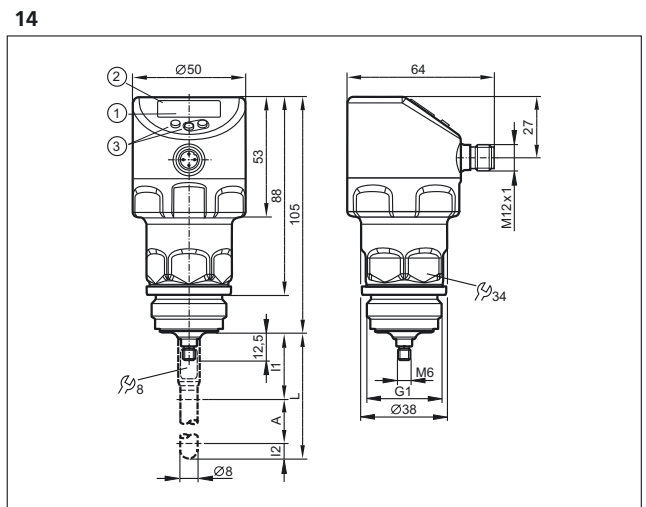

Scale drawings / drawing no. – CAD download: www.ifm.com

15

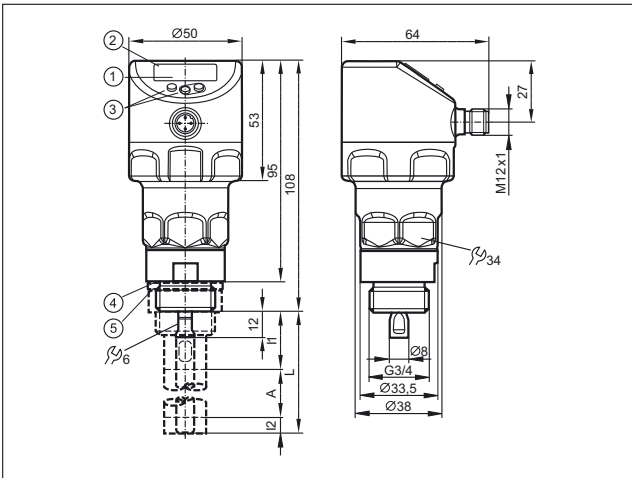

16

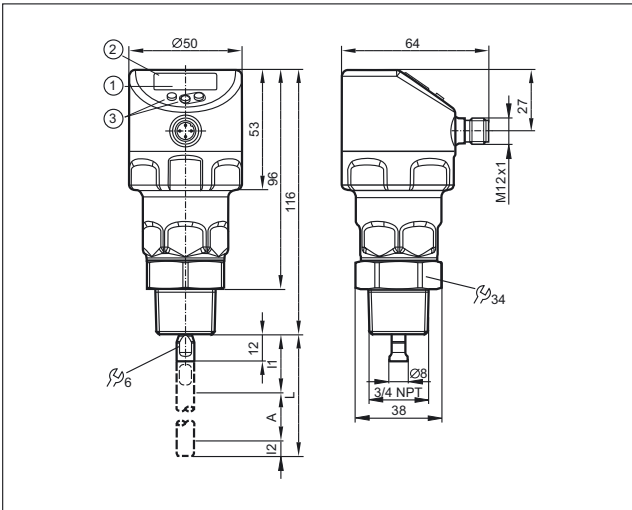

17

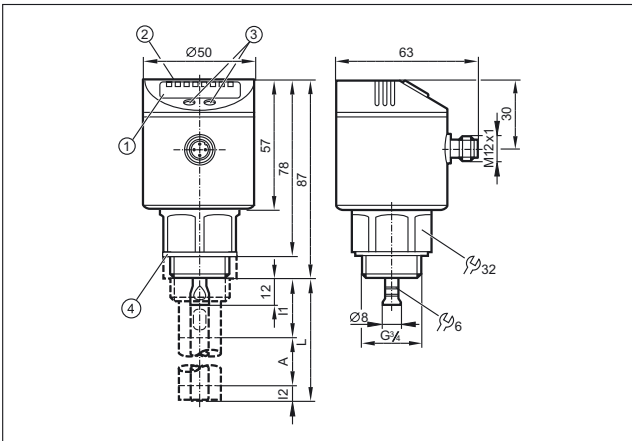

1: 4-digit alphanumeric display, 2: LEDs (display unit / switching status), 3: Programming buttons, 4: sealing, A: Active range, I1 / I2: Inactive ranges

18

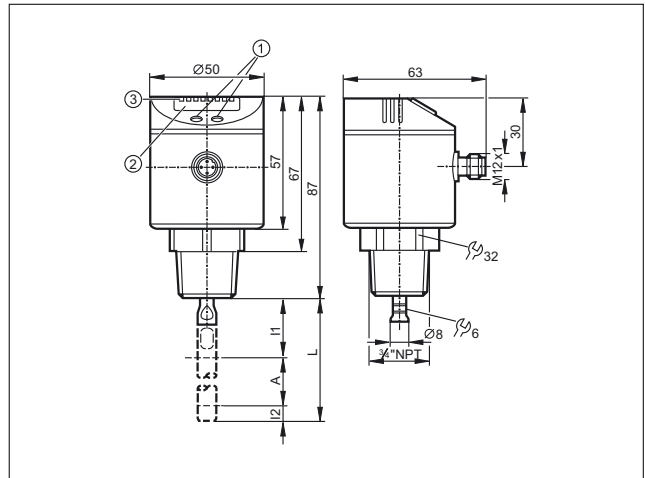

1: 4-digit alphanumeric display, 2: LEDs (display unit / switching status), 3: Programming buttons, A: Active range, I1 / I2: Inactive ranges

19

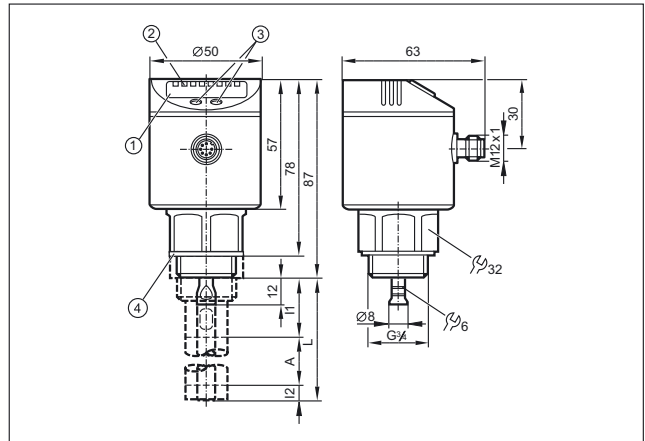

1: 4-digit alphanumeric display, 2: LEDs (display unit / switching status), 3: Programming buttons, 4: sealing, A: Active range, I1 / I2: Inactive ranges

20

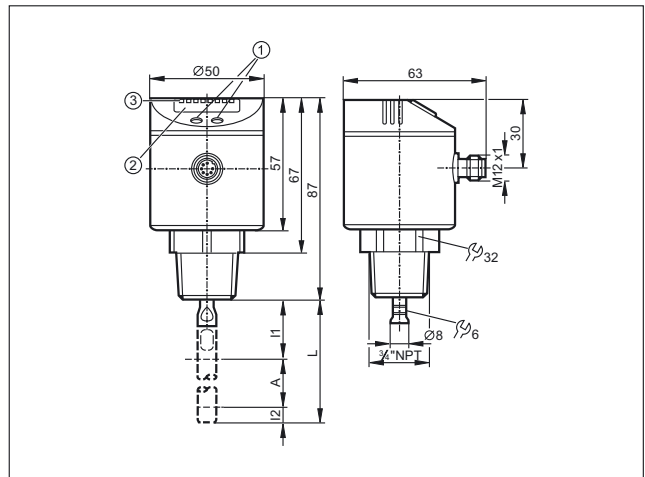



Process sensors

Scale drawings / drawing no. – CAD download: www.ifm.com

21

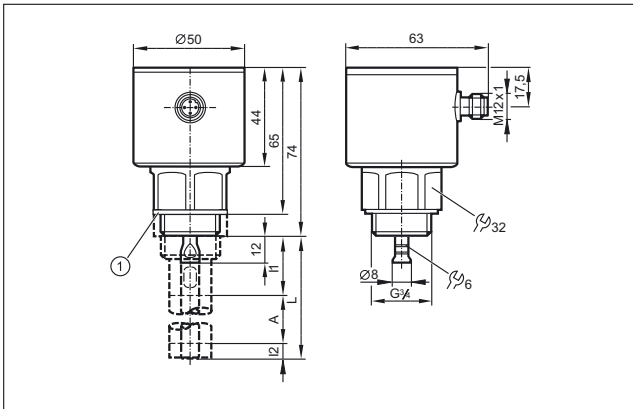

26

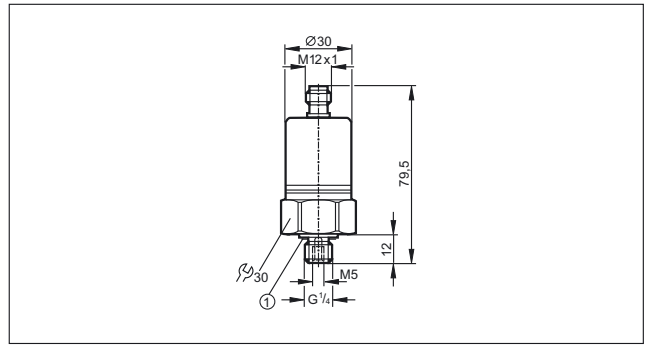

1: sealing FPM / DIN 3869-14

22

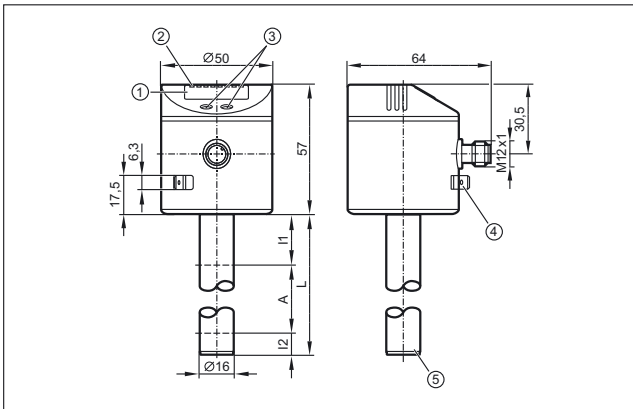

1: 4-digit alphanumeric display, 2: LEDs, 3: Programming buttons, 4: Housing connection (flat-pin connector 6.3 mm following DIN 46244), 5: Position of the temperature measuring element

27

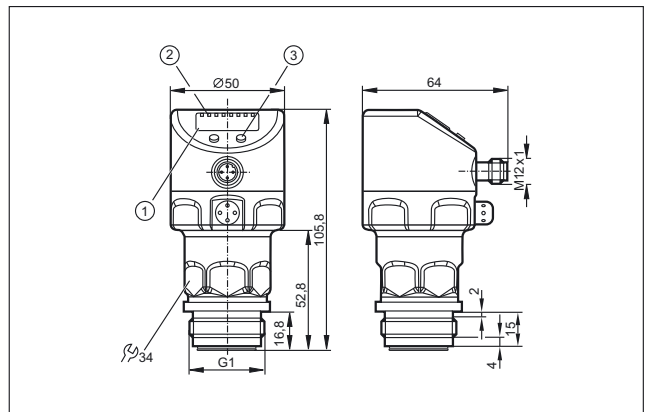

1: 4-digit alphanumeric display, 2: status LEDs, 3: Programming button

23

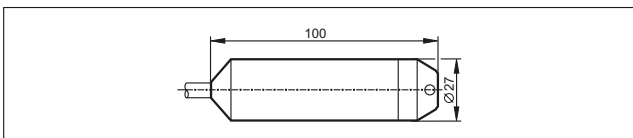

24

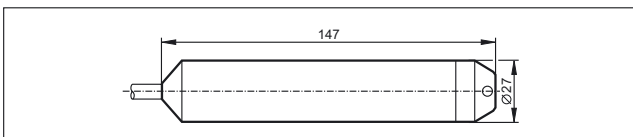

25

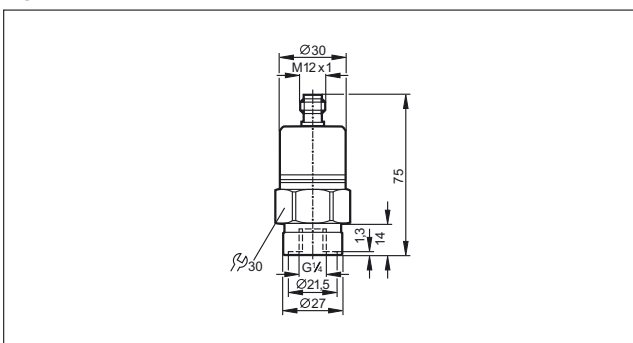

28

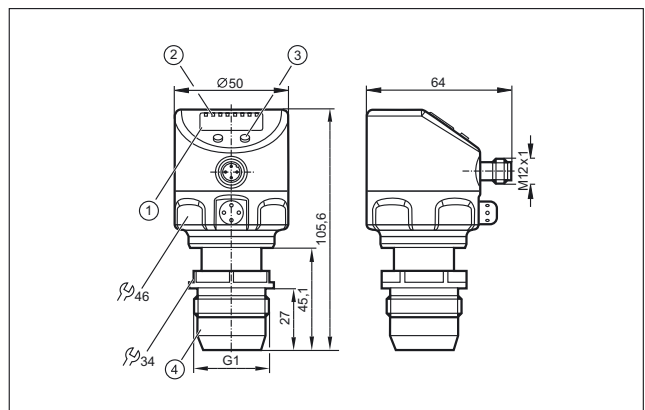

Scale drawings / drawing no. – CAD download: www.ifm.com

29

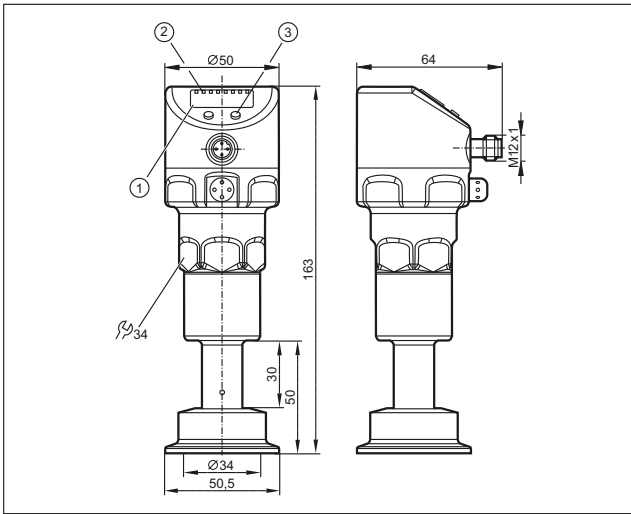

1: 4-digit alphanumeric display, 2: status LEDs, 3: Programming button

30

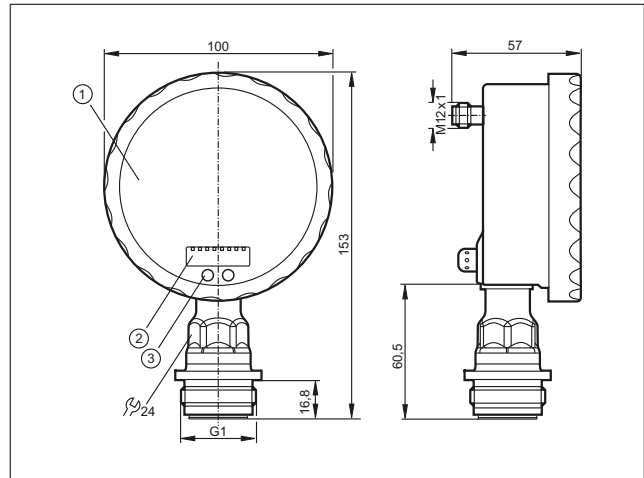

1: Analogue display, 2: 4-digit alphanumeric display, 3: Programming button

31

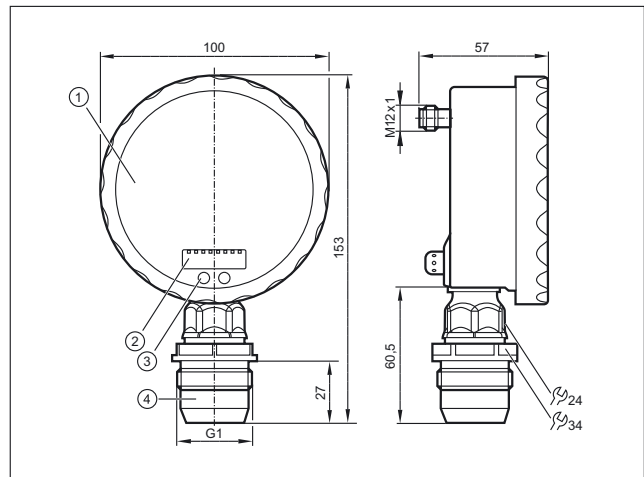

1: Analogue display, 2: 4-digit alphanumeric display, 3: Touch button (programming button), 4: Sealing cone G1 male, Attention: The unit must only be installed in a process connection for G1 sealing cone! The G1 male sealing cone of the unit is only suited for adapters with metal end stop!



Process sensors

Versatile temperature sensors – for all kinds of applications



Temperature sensors



Temperature sensors in contact with the medium for industrial and hygienic applications

Modular concept – tailor-made for all kinds of applications

Various fittings available for process connections

Robust mechanics with high vibration and shock resistance

Non-contact infrared temperature sensors for hot objects



Direct temperature sensors

The temperature sensors of ifm are based on a PT100 or PT1000 resistor. The measured temperature value corresponds to a change in resistance and is converted into an electrical analogue signal. A microprocessor controls the evaluation of the electrical signal. Depending on the product version, the current system temperature is indicated via LED display and provided as a switching signal, analogue signal or via IO-Link.

Indirect temperature measurement

In most cases the infrared temperature measurement is used where temperatures can only be measured indirectly, that means without contact. The reason for this can, for example, a high object temperature. The sensors detect the infrared radiation emitted by the objects and convert them into an output signal.

System overview	Page
TK sensors with mechanical setting and switching outputs	546
Compact temperature sensors with display, IO-Link	546 - 547
Control monitors for temperature sensors, IO-Link	547
Modular temperature transmitters	547
Pt1000 probe sensors for industrial applications	548
Pt100 probe sensors for industrial applications	548 - 549
Screw-in sensors for industrial applications	549
Cable sensors for industrial applications	550 - 551
Cable sensors with bolt-on sensor for industrial applications	551
Screw-in sensor with ATEX approval 3D/3G	552
Cable sensors with ATEX approval 3D / 3G	552
Cable sensors with bolt-on sensors with ATEX approval 3D / 3G	552
Temperature transmitters for standard applications, IO-Link	552 - 553
IO-Link temperature transmitters	553 - 554
Probe sensors for hygienic and wet areas	554 - 555
Sensors with process connection for hygienic and wet areas	555 - 556
Temperature transmitters for hygienic and wet areas, IO-Link	556 - 557
Self-monitoring temperature transmitters for hygienic and wet areas, IO-Link	557
Temperature transmitter with display for hygienic and wet areas, IO-Link	558 - 560
TV sensors with switching outputs, IO-Link	560
Infrared temperature sensors	560 - 561
Accessories for temperature sensors TN / TR	561
Accessories for infrared temperature sensors	561 - 562
Accessories	562
Software	562
Certificates	562 - 563
Thermowells for temperature sensors	563 - 565
Adapters	565 - 567
Hygienic adapters	567 - 571
Wiring diagrams	571 - 572
Scale drawings / drawing no. – CAD download: www.ifm.com	572 - 578





Process sensors

TK sensors with mechanical setting and switching outputs

Type	Measuring range [°C / °F]	Process connection	Installation length [mm]	U _b [V]	Dynamic response T05 / T09 [s]	Drawing no.	Order no.
M12 connector · Output function · DC PNP · Wiring diagram no. 1 · Connector groups 8, 9, 10, 11, 18, 19, 21, 23, 25, 148, 149, 150, 151, 153, 154, 184, 188, 189, 190, 193, 202, 203, 204							
	-20...140 / -4...284	G 1/4	50	9.6...32	1 / 3	1	TK6110
	-20...140 / -4...284	1/4" NPT	50	9.6...32	1 / 3	2	TK6310
M12 connector · Output function · DC PNP · Wiring diagram no. 2 · Connector groups 8, 9, 10, 11, 18, 19, 21, 23, 25, 148, 149, 150, 151, 153, 154, 184, 188, 190, 193, 202, 203, 204							
	-25...140 / -13...284	G 1/4	50	9.6...32	1 / 3	1	TK7110
M12 connector · Output function 1 x normally open / 1 x normally closed · DC PNP · Wiring diagram no. 1 · Connector groups 8, 9, 10, 11, 18, 19, 21, 23, 25, 148, 149, 150, 151, 153, 154, 184, 188, 190, 193, 202, 203, 204							
	-25...140 / -13...284	G 1/2	250	9.6...32	1 / 3	3	TK7460

Compact temperature sensors with display, IO-Link



Type	Factory setting [°C / °F]	Process connection	Installation length [mm]	U _b [V]	Dynamic response T05 / T09 [s]	Drawing no.	Order no.
M12 connector · Output function 1 x normally open / closed programmable + 1 x analogue (4...20 mA / 0...10 V, scaleable) · DC PNP/NPN · Wiring diagram no. 3 · Connector groups 8, 10, 19, 21, 23, 25, 148, 149, 153, 184, 188, 193, 202							
	-50...150 / -58...302	M18 x 1.5	45	18...32	1 / 3	4	TN2511
M12 connector · Output function 2 x normally open / closed programmable · DC PNP/NPN · Wiring diagram no. 3 · Connector groups 8, 10, 19, 21, 23, 25, 148, 149, 153, 184, 188, 193, 202							
	-50...150 / -58...302	M18 x 1.5	45	18...32	1 / 3	4	TN7511
M12 connector · Output function 2 x normally open / closed progr. or 1 x normally open / closed progr. + 1 x analogue (4...20 mA / 0...10 V) · DC PNP/NPN · Wiring diagram no. 3 · Connector groups 8, 10, 19, 21, 23, 25, 148, 149, 153, 184, 188, 193, 202							
	-50...150 / -58...302	G 1/2	30	18...32	1 / 3	5	TN2405
	-50...150 / -58...302	G 1/2	50	18...32	1 / 3	6	TN2415
	-50...150 / -58...302	G 1/2	100	18...32	1 / 3	7	TN2435
	-50...150 / -58...302	G 1/2	150	18...32	1 / 3	7	TN2445

Type	Factory setting [°C / °F]	Process connection	Installation length [mm]	U _b [V]	Dynamic response T05 / T09 [s]	Drawing no.	Order no.
M12 connector · Output function 2 x normally open / closed progr. or 1 x normally open / closed progr. + 1 x analogue (4...20 mA / 0...10 V) · DC PNP/NPN · Wiring diagram no. 3 · Connector groups 8, 10, 19, 21, 23, 25, 148, 149, 153, 184, 188, 193, 202							
	-50...150 / -58...302	G 1/4	25	18...32	1 / 3	8	TN2105
	-50...150 / -58...302	G 1/4	50	18...32	1 / 3	9	TN2115

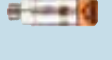
Control monitors for temperature sensors, IO-Link

Type	Measuring range [°C]	Process connection	Display	U _b [V]	Current consumption [mA]	I _{load} [mA]	Drawing no.	Order no.
M12 connector · Output function 1 x normally open / closed programmable + 1 x analogue (4...20 mA / 0...10 V, scalable) · DC PNP/NPN · Wiring diagram no. 3 · Connector groups 8, 10, 19, 21, 23, 25, 148, 149, 153, 184, 188, 193, 202								
	-100...600 / -148...1112	G ½ A	Display unit	18...32	50	250	10	TR2439
M12 connector · Output function 2 x normally open / closed programmable · DC PNP/NPN · Wiring diagram no. 3 · Connector groups 8, 10, 19, 21, 23, 25, 148, 149, 153, 184, 188, 193, 202								
	-100...600 / -148...1112	G ½ A	Display unit	18...32	50	250	10	TR7439



Modular temperature transmitters

Type	Factory setting [°C / °F]	Process connection	U _b [V]	Ambient temperature [°C]	Measuring element	Drawing no.	Order no.
M12 connector · Output function 4...20 mA analogue · DC · Wiring diagram no. 6 · Connector groups 8, 10, 19, 21, 23, 25, 148, 149, 153, 184, 188, 193, 202							
	-50...300 / -58...572	M12	20...32	-25...70	for Pt100 and Pt1000 measuring elements	11	TP3232
	-50...300 / -58...572	M12	20...32	-25...70	for Pt100 and Pt1000 measuring elements	11	TP3237
	-50...300 / -58...572	M12	20...32	-25...70	for Pt100 and Pt1000 measuring elements	11	TP3231
M12 connector · Output function 0...10 V analogue · DC · Wiring diagram no. 7 · Connector groups 8, 10, 19, 21, 23, 25, 148, 149, 153, 184, 188, 193, 202							
	-50...300 / -58...572	M12	18...32	-25...70	for Pt100 and Pt1000 measuring elements	11	TP9237







Process sensors

Pt1000 probe sensors for industrial applications



Type	Measuring range [°C]	Diameter [mm]	Installation length [mm]	Sensor element	Dynamic response T05 / T09 [s]	Drawing no.	Order no.
M12 connector · high-grade stainless steel · Wiring diagram no. 4							
	-40...150	6	160	1 x Pt 1000	1 / 3	12	TT1250
	-40...150	6	260	1 x Pt 1000	1 / 3	12	TT2250
	-40...150	6	360	1 x Pt 1000	1 / 3	12	TT3250
	-40...150	10	160	1 x Pt 1000	1 / 3	13	TT1050
	-40...150	10	260	1 x Pt 1000	1 / 3	13	TT2050
	-40...150	10	360	1 x Pt 1000	1 / 3	13	TT3050
	-40...150	10	560	1 x Pt 1000	1 / 3	13	TT5050

Pt100 probe sensors for industrial applications

Type	Measuring range [°C]	Diameter [mm]	Installation length [mm]	Sensor element	Dynamic response T05 / T09 [s]	Drawing no.	Order no.
M12 connector · high-grade stainless steel · Connector groups 8, 10, 19, 21, 23, 25, 148, 149, 153, 184, 188, 193, 202							
	-40...150	6	70	1 x Pt 100	1 / 3	14	TT7281
	-40...150	6	100	1 x Pt 100	1 / 3	14	TT0281
	-40...150	6	150	1 x Pt 100	1 / 3	14	TT1281
	-40...150	6	250	1 x Pt 100	1 / 3	14	TT2281
	-40...150	6	200	1 x Pt 100	1 / 3	14	TT4281
	-40...150	6	300	1 x Pt 100	1 / 3	14	TT6281

Type	Measuring range [°C]	Diameter [mm]	Installation length [mm]	Sensor element	Dynamic response T05 / T09 [s]	Drawing no.	Order no.
M12 connector · high-grade stainless steel · Connector groups 8, 10, 19, 21, 23, 25, 148, 149, 153, 184, 188, 193, 202							
	-40...150	6	350	1 x Pt 100	1 / 3	14	TT3281
	-40...150	6	50	1 x Pt 100	1 / 3	14	TT9281
	-40...150	10	160	1 x Pt 100	1 / 3	13	TT1081
	-40...150	10	260	1 x Pt 100	1 / 3	13	TT2081
	-40...150	10	360	1 x Pt 100	1 / 3	13	TT3081
	-40...150	10	560	1 x Pt 100	1 / 3	13	TT5081
	-40...125	8.2	60	1 x Pt 100	1 / 3	15	TM9950

Screw-in sensors for industrial applications











Type	Measuring range [°C]	Process connection	Installation length [mm]	Sensor element	Dynamic response T05 / T09 [s]	Drawing no.	Order no.
M12 connector · high-grade stainless steel · Connector groups 8, 10, 19, 21, 23, 25, 148, 149, 153, 184, 188, 193, 202							
	-40...150	G ¼	25	1 x Pt 100	1 / 3	16	TM4101
	-40...150	G ¼	25	1 x Pt 1000	1 / 3	16	TM5101
	-40...150	G ½	50	1 x Pt 100	1 / 3	17	TM4411
	-40...150	G ½	50	1 x Pt 1000	1 / 3	17	TM5411
	-40...150	G ½	100	1 x Pt 100	1 / 3	17	TM4431
	-40...150	G ½	150	1 x Pt 100	1 / 3	17	TM4441
	-40...150	G ½	250	1 x Pt 100	1 / 3	17	TM4461

You can find wiring diagrams and scale drawings from page 571



Process sensors

Cable sensors for industrial applications

Type	Measuring range [°C]	Diameter [mm]	Cable material	Sensor element	Dynamic response T05 / T09 [s]	Drawing no.	Order no.
Cable 4 m · high-grade stainless steel							
	-30...180	M5	silicone cable	1 x Pt 100	3 / 8	18	TS4759
Cable with connector 0.15 m · high-grade stainless steel · Connector groups 8, 10, 19, 21, 23, 25, 148, 149, 153, 184, 188, 193, 202							
	-50...250	Ø 6 mm	PTFE cable	1 x Pt 1000	11 / 37	19	TS9256
Cable with connector 0.5 m · high-grade stainless steel · Connector groups 8, 10, 19, 21, 23, 25, 148, 149, 153, 184, 188, 193, 202							
	-40...90	M5 / L = 26	PUR cable	1 x Pt 100	3 / 8	20	TS9789
Cable with connector 2 m · high-grade stainless steel · Connector groups 8, 10, 19, 21, 23, 25, 148, 149, 153, 184, 188, 193, 202							
	-40...90	Ø 6 mm / L = 45 mm	PUR cable	1 x Pt 100	3 / 10	21	TS2289
	-40...90	Ø 6 mm / L = 45 mm	PUR cable	1 x Pt 1000	3 / 10	21	TS2269
	-40...90	Ø 10 mm	PUR cable	1 x Pt 100	6 / 25	22	TS2089
	-40...90	Ø 10 mm	PUR cable	1 x Pt 1000	6 / 25	22	TS2069
	-50...250	Ø 6 mm	PTFE cable	1 x Pt 100	11 / 37	19	TS2256
	-50...250	Ø 10 mm	PTFE cable	1 x Pt 100	12 / 39	23	TS2056
	-40...90	M5 / L = 26	PUR cable	1 x Pt 100	3 / 8	20	TS2789
	-40...90	M6 / L = 26	PUR cable	1 x Pt 100	3 / 9	24	TS2689
	-30...180	M5 / L = 25.7	silicone cable	1 x Pt 100	3 / 8	25	TS2759
	-30...180	M6	silicone cable	1 x Pt 100	3 / 8	26	TS2659

Type	Measuring range [°C]	Diameter [mm]	Cable material	Sensor element	Dynamic response T05 / T09 [s]	Drawing no.	Order no.
------	-------------------------	------------------	----------------	----------------	--------------------------------------	-------------	-----------

Cable with connector 2.5 m · high-grade stainless steel · Connector groups 8, 10, 19, 21, 23, 25, 148, 149, 153, 184, 188, 193, 202

	-40...90	Ø 6 mm / L = 45 mm	PUR cable	1 x Pt 100	3 / 10	21	TS9289
---	----------	--------------------	-----------	------------	--------	----	--------

Cable with connector 5 m · high-grade stainless steel · Connector groups 8, 10, 19, 21, 23, 25, 148, 149, 153, 184, 188, 193, 202

	-40...90	Ø 10 mm	PUR cable	1 x Pt 100	6 / 25	22	TS5089
---	----------	---------	-----------	------------	--------	----	--------

	-40...90	Ø 6 mm / L = 45 mm	PUR cable	1 x Pt 100	3 / 10	21	TS5289
---	----------	--------------------	-----------	------------	--------	----	--------

Cable with connector 10 m · high-grade stainless steel · Connector groups 8, 10, 19, 21, 23, 25, 148, 149, 153, 184, 188, 193, 202

	-30...180	M5 / L = 25.7	silicone cable	1 x Pt 100	3 / 8	25	TS0759
---	-----------	---------------	----------------	------------	-------	----	--------

Cable with connector 2 m · high-grade stainless steel · Connector groups 8, 10, 19, 21, 23, 25, 148, 149, 153, 184, 188, 193, 202

	-100...600	Ø 6 mm	PTFE cable	1 x Pt 100	12 / 34	27	TS2451
---	------------	--------	------------	------------	---------	----	--------

	-100...600	Ø 6 mm	PTFE cable	1 x Pt 100	12 / 34	27	TS2452
---	------------	--------	------------	------------	---------	----	--------

	-100...600	Ø 6 mm	PTFE cable	1 x Pt 100	12 / 34	27	TS2453
---	------------	--------	------------	------------	---------	----	--------

	-100...600	Ø 6 mm	PTFE cable	1 x Pt 100	12 / 34	27	TS2454
---	------------	--------	------------	------------	---------	----	--------

Cable sensors with bolt-on sensor for industrial applications

Type	Measuring range [°C]	Diameter [mm]	Cable material	Sensor element	Dynamic response T05 / T09 [s]	Drawing no.	Order no.
------	-------------------------	------------------	----------------	----------------	--------------------------------------	-------------	-----------

Cable with connector 2 m · stainless steel · Connector groups 8, 10, 19, 21, 23, 25, 148, 149, 153, 184, 188, 193, 202

	-40...90	12	PUR cable	1 x Pt 100	9 / 15	28	TS2229
---	----------	----	-----------	------------	--------	----	--------

Cable 2 m · stainless steel

	-40...90	12	PUR cable	1 x Pt 100	12 / 39	29	TS2239
---	----------	----	-----------	------------	---------	----	--------



Process sensors

Screw-in sensor with ATEX approval 3D/3G

Type	Measuring range [°C]	Diameter [mm]	Cable material	Sensor element	Dynamic response T05 / T09 [s]	Drawing no.	Order no.
------	-------------------------	------------------	----------------	----------------	--------------------------------------	-------------	-----------

Cable 2 m · high-grade stainless steel · DC

	-20...115	M5	silicone cable	1 x Pt 100	8 / 20	30	TS285A
---	-----------	----	----------------	------------	--------	----	--------

Cable sensors with ATEX approval 3D / 3G

Type	Measuring range [°C]	Diameter [mm]	Cable material	Sensor element	Dynamic response T05 / T09 [s]	Drawing no.	Order no.
------	-------------------------	------------------	----------------	----------------	--------------------------------------	-------------	-----------



Cable 3 m · high-grade stainless steel

	-20...80	Ø 5 mm / L = 40	silicone cable	1 x Pt 100	4 / 10	31	TS325A
---	----------	-----------------	----------------	------------	--------	----	--------

Cable sensors with bolt-on sensors with ATEX approval 3D / 3G

Type	Measuring range [°C]	Diameter [mm]	Cable material	Sensor element	Dynamic response T05 / T09 [s]	Drawing no.	Order no.
------	-------------------------	------------------	----------------	----------------	--------------------------------------	-------------	-----------



Cable 5 m · high-grade stainless steel







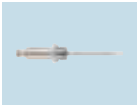

	-20...80	10	silicone cable	1 x Pt 100	13 / 39	32	TS522A
	-20...80	18	silicone cable	1 x Pt 1000	18 / 42	33	TS502A

Temperature transmitters for standard applications, IO-Link





Type	Factory setting [°C / °F]	Process connection	Installation length [mm]	U _b [V]	Dynamic response T05 / T09 [s]	Drawing no.	Order no.
------	------------------------------	--------------------	-----------------------------	-----------------------	--------------------------------------	-------------	-----------

M12 connector · high-grade stainless steel · DC · Connector groups 8, 10, 19, 21, 23, 25, 148, 149, 153, 184, 188, 193, 202

	-50...150 / -	G ½	30	18...32	1 / 3	34	TA2405
	-50...150 / -	G ½	50	18...32	1 / 3	34	TA2415
	0...100 / -	G ½	50	18...32	1 / 3	34	TA2417

Type	Factory setting [°C / °F]	Process connection	Installation length [mm]	U _b [V]	Dynamic response T05 / T09 [s]	Drawing no.	Order no.
M12 connector · high-grade stainless steel · DC · Connector groups 8, 10, 19, 21, 23, 25, 148, 149, 153, 184, 188, 193, 202							
	-50...150 / -	G ½	100	18...32	1 / 3	34	TA2435
	0...100 / -	G ½	100	18...32	1 / 3	34	TA2437
	-50...150 / -	G ½	150	18...32	1 / 3	34	TA2445
	0...100 / -	G ½	150	18...32	1 / 3	34	TA2447
	-50...150 / -	G ¼	25	18...32	1 / 3	35	TA2105
	-50...150 / -	G ¼	50	18...32	1 / 3	35	TA2115
	-50...150 / -	G ¼	100	18...32	1 / 3	35	TA2135
	-50...150 / -	G ¼	150	18...32	1 / 3	35	TA2145

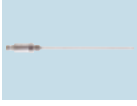
IO-Link temperature transmitters

Type	Measuring range [°C / °F]	Process connection	Installation length [mm]	U _b [V]	Dynamic response T05 / T09 [s]	Drawing no.	Order no.
M12 connector · high-grade stainless steel · DC · Connector groups 8, 10, 19, 21, 23, 25, 148, 149, 153, 184, 188, 193, 202							
	-50...150 / -58...302	G ¼ A	25	10...30	1 / 3	36	TA3105
	-50...150 / -58...302	G ¼ A	50	10...30	1 / 3	36	TA3115
	-50...150 / -58...302	G ¼ A	200	10...30	1 / 3	36	TA3155
DEUTSCH connector · high-grade stainless steel · DC							
	-50...150 / -58...302	G ¼ A	25	10...30	1 / 3	37	TA4105



Process sensors

Type	Measuring range [°C / °F]	Process connection	Installation length [mm]	U _b [V]	Dynamic response T05 / T09 [s]	Drawing no.	Order no.
------	------------------------------	--------------------	-----------------------------	-----------------------	--------------------------------------	-------------	-----------

DEUTSCH connector · high-grade stainless steel · DC

	-50...150 / -58...302	G ¼ A	50	10...30	1 / 3	37	TA4115
---	-----------------------	-------	----	---------	-------	----	--------

AMP plug · high-grade stainless steel · DC

	-50...150 / -58...302	G ¼ A	25	10...30	1 / 3	38	TA5105
---	-----------------------	-------	----	---------	-------	----	--------

	-50...150 / -58...302	G ¼ A	50	10...30	1 / 3	38	TA5115
---	-----------------------	-------	----	---------	-------	----	--------

M12 connector · high-grade stainless steel · DC · Connector groups 8, 10, 19, 21, 23, 25, 148, 149, 153, 184, 188, 193, 202

	-50...150 / -58...302	G ¼ A	25	8...32	1 / 3	36	TU3105
---	-----------------------	-------	----	--------	-------	----	--------

DEUTSCH connector · high-grade stainless steel · DC

	-50...150 / -58...302	G ¼ A	25	8...32	1 / 3	37	TU4105
---	-----------------------	-------	----	--------	-------	----	--------

AMP plug · high-grade stainless steel · DC

	-50...150 / -58...302	G ¼ A	25	8...32	1 / 3	38	TU5105
---	-----------------------	-------	----	--------	-------	----	--------

M12 connector · high-grade stainless steel · Connector groups 8, 10, 19, 21, 23, 25, 148, 149, 153, 184, 188, 193, 202

	-40...150 / -40...302	G ¼	25	–	1 / 3	16	TM5101
---	-----------------------	-----	----	---	-------	----	--------

DEUTSCH connector · high-grade stainless steel

	-40...150 / -40...302	G 1/4	25	–	1 / 3	39	TM6101
---	-----------------------	-------	----	---	-------	----	--------

Probe sensors for hygienic and wet areas

Type	Measuring range [°C]	Diameter [mm]	Installation length [mm]	Sensor element	Dynamic response T05 / T09 [s]	Drawing no.	Order no.
------	-------------------------	------------------	-----------------------------	----------------	--------------------------------------	-------------	-----------

M12 connector · high-grade stainless steel · Connector groups 8, 10, 19, 21, 23, 25, 148, 149, 153, 184, 188, 193, 202

	-40...150	6	50	1 x Pt 100	1 / 3	14	TT9291
---	-----------	---	----	------------	-------	----	--------

	-40...150	6	100	1 x Pt 100	1 / 3	14	TT0291
---	-----------	---	-----	------------	-------	----	--------

Type	Measuring range [°C]	Diameter [mm]	Installation length [mm]	Sensor element	Dynamic response T05 / T09 [s]	Drawing no.	Order no.
------	-------------------------	------------------	-----------------------------	----------------	--------------------------------------	-------------	-----------



M12 connector · high-grade stainless steel · Connector groups 8, 10, 19, 21, 23, 25, 148, 149, 153, 184, 188, 193, 202

	-40...150	6	150	1 x Pt 100	1 / 3	14	TT1291
	-40...150	6	250	1 x Pt 100	1 / 3	14	TT2291
	-40...150	6	350	1 x Pt 100	1 / 3	14	TT3291

Sensors with process connection for hygienic and wet areas



Type	Measuring range [°C]	Process connection	Installation length [mm]	Sensor element	Dynamic response T05 / T09 [s]	Drawing no.	Order no.
------	-------------------------	--------------------	-----------------------------	----------------	--------------------------------------	-------------	-----------

M12 connector · high-grade stainless steel · Connector groups 8, 10, 19, 21, 23, 25, 148, 149, 153, 184, 188, 193, 202









	-40...150	Clamp 1-1.5" ISO 2852	30	1 x Pt 100	1 / 3	40	TM4801
	-40...150	Clamp 1-1.5" ISO 2852	50	1 x Pt 100	1 / 3	40	TM4811
	-40...150	Clamp 1-1.5" ISO 2852	100	1 x Pt 100	1 / 3	40	TM4831
	-40...150	Clamp 1-1.5" ISO 2852	150	1 x Pt 100	1 / 3	40	TM4841
	-40...150	Clamp 2"	30	1 x Pt 100	1 / 3	41	TM4901
	-40...150	Clamp 2"	50	1 x Pt 100	1 / 3	41	TM4911
	-40...150	Clamp 2"	100	1 x Pt 100	1 / 3	41	TM4931
	-40...150	Clamp 2"	150	1 x Pt 100	1 / 3	41	TM4941
	-40...150	G½ with sealing cone	20	1 x Pt 100	1 / 3	42	TM4591
	-40...150	G½ with sealing cone	30	1 x Pt 100	1 / 3	42	TM4501
	-40...150	G½ with sealing cone	50	1 x Pt 100	1 / 3	42	TM4511

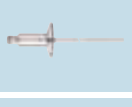

Process sensors

Type	Measuring range [°C]	Process connection	Installation length [mm]	Sensor element	Dynamic response T05 / T09 [s]	Drawing no.	Order no.
M12 connector · high-grade stainless steel · Connector groups 8, 10, 19, 21, 23, 25, 148, 149, 153, 184, 188, 193, 202							
	-40...150	G½ with sealing cone	100	1 x Pt 100	1 / 3	42	TM4531
	-40...150	G½ with sealing cone	150	1 x Pt 100	1 / 3	42	TM4541
	-50...140	G½ with sealing cone	–	1 x Pt 100	10 / 40	43	TM4599

Temperature transmitters for hygienic and wet areas, IO-Link

Type	Measuring range [°C / °F]	Process connection	Installation length [mm]	U _b [V]	Dynamic response T05 / T09 [s]	Drawing no.	Order no.
M12 connector · high-grade stainless steel · DC · Connector groups 148, 153, 184, 188, 193							
	-50...200 / -	3/4" clamp (ISO 2852)	25	18...32	< 0.5 / < 2.0	44	TA2002
	-50...200 / -	3/4" clamp (ISO 2852)	60	18...32	< 0.5 / < 2.0	44	TA2012
	-50...200 / -	1.5" clamp (ISO 2852)	30	18...32	< 0.5 / < 2	45	TA2802
	-50...200 / -	1.5" clamp (ISO 2852)	50	18...32	< 0.5 / < 2	45	TA2812
	-50...200 / -	1.5" clamp (ISO 2852)	100	18...32	< 0.5 / < 2	45	TA2832
	-50...200 / -	1.5" clamp (ISO 2852)	150	18...32	< 0.5 / < 2	45	TA2842
	-50...200 / -	G½ with sealing cone	30	18...32	< 0.5 / < 2	46	TA2502
	-50...200 / -	G½ with sealing cone	50	18...32	< 0.5 / < 2	46	TA2512
	-50...200 / -	G½ with sealing cone	100	18...32	< 0.5 / < 2	46	TA2532
	-50...200 / -	G½ with sealing cone	150	18...32	< 0.5 / < 2	46	TA2542

Type	Measuring range [°C / °F]	Process connection	Installation length [mm]	U _b [V]	Dynamic response T05 / T09 [s]	Drawing no.	Order no.
------	------------------------------	--------------------	-----------------------------	-----------------------	--------------------------------------	-------------	-----------

M12 connector · high-grade stainless steel · DC

	0...100 / -	G½ with sealing cone	-	18...32	10 / 40	47	TA3597
---	-------------	----------------------	---	---------	---------	----	--------

M12 connector · high-grade stainless steel · DC · Connector groups 148, 153, 184, 188, 193

	-50...200 / -	Ø 6 mm	50	18...32	< 0.5 / < 2	48	TA2212
---	---------------	--------	----	---------	-------------	----	--------

	-50...200 / -	Ø 6 mm	100	18...32	< 0.5 / < 2	48	TA2232
---	---------------	--------	-----	---------	-------------	----	--------

	-50...200 / -	Ø 6 mm	150	18...32	< 0.5 / < 2	48	TA2242
---	---------------	--------	-----	---------	-------------	----	--------

Self-monitoring temperature transmitters for hygienic and wet areas, IO-Link

Type	Factory setting [°C / °F]	Process connection	Installation length [mm]	U _b [V]	Dynamic response T05 / T09 [s]	Drawing no.	Order no.
------	------------------------------	--------------------	-----------------------------	-----------------------	--------------------------------------	-------------	-----------

M12 connector · Output function normally open / normally closed / heartbeat programmable, 4...20 mA analogue · DC PNP/NPN · Wiring diagram no. 8 · Connector groups 8, 10, 19, 21, 23, 25, 148, 149, 153, 184, 188, 193, 202

	0...150 / 32...302	Aseptoflex Vario	50	18...32	3 / 6	49	TAD081
---	--------------------	------------------	----	---------	-------	----	--------

	0...150 / 32...302	Aseptoflex Vario	87.5	18...32	3 / 6	50	TAD181
---	--------------------	------------------	------	---------	-------	----	--------

	0...150 / 32...302	Aseptoflex Vario	33	18...32	3 / 6	51	TAD981
---	--------------------	------------------	----	---------	-------	----	--------

	0...150 / 32...302	G ½ A	50	18...32	3 / 6	52	TAD091
---	--------------------	-------	----	---------	-------	----	--------



	0...150 / 32...302	G ½ A	87.5	18...32	3 / 6	53	TAD191
---	--------------------	-------	------	---------	-------	----	--------



	0...150 / 32...302	G ½ A	33	18...32	3 / 6	54	TAD991
---	--------------------	-------	----	---------	-------	----	--------



Process sensors

Temperature transmitter with display for hygienic and wet areas, IO-Link

Type	Factory setting [°C / °F]	Process connection	Installation length [mm]	U _b [V]	Dynamic response T05 / T09 [s]	Drawing no.	Order no.
M12 connector · DC · Wiring diagram no. 9 · Connector groups 8, 10, 19, 21, 23, 25, 148, 149, 153, 184, 188, 193, 202							
	-50...150 / -58...302	G½ with sealing cone	30	18...32	1 / 3	55	TD2507
	-50...150 / -58...302	G½ with sealing cone	50	18...32	1 / 3	55	TD2517
	-50...150 / -58...302	G½ with sealing cone	100	18...32	1 / 3	55	TD2537
	-50...150 / -58...302	G½ with sealing cone	150	18...32	1 / 3	55	TD2547
	-50...150 / -58...302	G½ with sealing cone	30	18...32	1 / 3	55	TD2501
	-50...150 / -58...302	G½ with sealing cone	50	18...32	1 / 3	55	TD2511
	-50...150 / -58...302	G½ with sealing cone	100	18...32	1 / 3	55	TD2531
	-50...150 / -58...302	G½ with sealing cone	150	18...32	1 / 3	55	TD2541
	-50...150 / -58...302	1.5" clamp (ISO 2852)	30	18...32	1 / 3	56	TD2807
	-50...150 / -58...302	1.5" clamp (ISO 2852)	50	18...32	1 / 3	56	TD2817
	-50...150 / -58...302	1.5" clamp (ISO 2852)	100	18...32	1 / 3	56	TD2837
	-50...150 / -58...302	1.5" clamp (ISO 2852)	150	18...32	1 / 3	56	TD2847
	-50...150 / -58...302	1.5" clamp (ISO 2852)	30	18...32	1 / 3	56	TD2801
	-50...150 / -58...302	1.5" clamp (ISO 2852)	50	18...32	1 / 3	56	TD2811
	-50...150 / -58...302	1.5" clamp (ISO 2852)	100	18...32	1 / 3	56	TD2831
	-50...150 / -58...302	1.5" clamp (ISO 2852)	150	18...32	1 / 3	56	TD2841



Type	Factory setting [°C / °F]	Process connection	Installation length [mm]	U _b [V]	Dynamic response T05 / T09 [s]	Drawing no.	Order no.
M12 connector · DC · Wiring diagram no. 9 · Connector groups 8, 10, 19, 21, 23, 25, 148, 149, 153, 184, 188, 193, 202							
	-50...150 / -58...302	2" clamp (ISO 2852)	30	18...32	1 / 3	57	TD2907
	-50...150 / -58...302	2" clamp (ISO 2852)	50	18...32	1 / 3	57	TD2917
	-50...150 / -58...302	2" clamp (ISO 2852)	100	18...32	1 / 3	57	TD2937
	-50...150 / -58...302	2" clamp (ISO 2852)	150	18...32	1 / 3	57	TD2947
	-50...150 / -58...302	2" clamp (ISO 2852)	30	18...32	1 / 3	57	TD2901
	-50...150 / -58...302	2" clamp (ISO 2852)	50	18...32	1 / 3	57	TD2911
	-50...150 / -58...302	2" clamp (ISO 2852)	100	18...32	1 / 3	57	TD2931
	-50...150 / -58...302	2" clamp (ISO 2852)	150	18...32	1 / 3	57	TD2941
	-50...150 / -58...302	Ø 6 mm	50	18...32	1 / 3	58	TD2217
	-50...150 / -58...302	Ø 6 mm	100	18...32	1 / 3	58	TD2237
	-50...150 / -58...302	Ø 6 mm	150	18...32	1 / 3	58	TD2247
	-50...150 / -58...302	Ø 6 mm	250	18...32	1 / 3	58	TD2267
	-50...150 / -58...302	Ø 6 mm	50	18...32	1 / 3	58	TD2211
	-50...150 / -58...302	Ø 6 mm	100	18...32	1 / 3	58	TD2231
	-50...150 / -58...302	Ø 6 mm	150	18...32	1 / 3	58	TD2241
	-50...150 / -58...302	Ø 6 mm	200	18...32	1 / 3	58	TD2251
-50...150 / -58...302	Ø 6 mm	250	18...32	1 / 3	58	TD2261	







Process sensors





Type	Factory setting [°C / °F]	Process connection	Installation length [mm]	U _b [V]	Dynamic response T05 / T09 [s]	Drawing no.	Order no.
M12 connector · DC · Wiring diagram no. 9 · Connector groups 8, 10, 19, 21, 23, 25, 148, 149, 153, 184, 188, 193, 202							
	-50...150 / -58...302	Ø 6 mm	200	18...32	1 / 3	58	TD2257
	-50...150 / -58...302	Ø 6 mm	300	18...32	1 / 3	58	TD2271
	-50...150 / -58...302	Ø 6 mm	300	18...32	1 / 3	58	TD2277
	-50...150 / -58...302	Ø 6 mm	350	18...32	1 / 3	58	TD2291
	-50...150 / -58...302	Ø 6 mm	350	18...32	1 / 3	58	TD2297

TV sensors with switching outputs, IO-Link

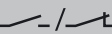

Type	Measuring range [°C / °F]	Process connection	Installation length [mm]	U _b [V]	Dynamic response T05 / T09 [s]	Drawing no.	Order no.
M12 connector · Output function 2 x normally open / closed progr. · 2 switching outputs · DC PNP/NPN · Wiring diagram no. 3 · Connector groups 8, 10, 12, 13, 19, 21, 22, 23, 24, 25, 148, 149, 150, 152, 153, 154, 155, 184, 186, 188, 190, 192, 193, 194, 202, 205							
	-50...150 / -	G 1/4	25	18...32	1 / 3	59	TV7105
	-50...150 / -	G 1/2	30	18...32	1 / 3	60	TV7405

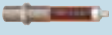
Infrared temperature sensors

Type	Temperature range [°C]	Wave length range [µm]	Material lens	Response time [ms]	Drawing no.	Order no.
M12 connector · Output function  /  · Switching output, Analogue output · DC PNP · Wiring diagram no. 5						
	0...999.5	8...14	Infrared transparent crystal lens with anti-reflex coating	< 100	61	TW2000
	250...1600	1.0...1.7	tempered optical glass	< 2	62	TW2001
	500...2500	0.78...1.06	tempered optical glass	< 2	62	TW2002
	300...1600	1.0...1.7	tempered optical glass	< 2	63	TW2011

Type	Temperature range [°C]	Wave length range [µm]	Material lens	Response time [ms]	Drawing no.	Order no.
M12 connector · Output function  · 2 switching outputs · DC PNP · Wiring diagram no. 5						
	50...500	8...14	Infrared transparent crystal lens with anti-reflex coating	< 100	64	TW7000
	250...1250	1.0...1.7	tempered optical glass	≤ 2	65	TW7001
	350...1350	1.0...1.7	tempered optical glass	≤ 2	66	TW7011

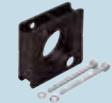
Accessories for temperature sensors TN / TR



Type	Description	Order no.
	Angle bracket · Housing materials: PA66-	E30421
	Mounting clamp · Ø 34 mm · Housing materials: PBT	E10017
	Mounting clamp · Ø 34 mm · Housing materials: PA	E10193

Accessories for infrared temperature sensors



Type	Description	Order no.
	Measuring head · for infrared temperature sensors TWxx11, M30 design · Housing materials: AlMg3 black anodised / 303 / 1.4305 / lock nuts: 304 / 1.4301 / O-ring: FPM	E35060
	Fibre optics with stainless steel sheathing · straight · Connection to infrared temperature sensors TWxx11 · ¼"-36UNS-2A · Housing materials: stainless steel, Fibre optic: Quartz/Quartz fibre (VIS/IR)	E35061
	Fibre optics with stainless steel sheathing · straight · Connection to infrared temperature sensors TWxx11 · ¼"-36UNS-2A · Housing materials: stainless steel, Fibre optic: Quartz/Quartz fibre (VIS/IR)	E35062
	Air purge · for infrared temperature sensors TWxxxx, M30 design · for type TW · Housing materials: stainless steel / Brass / sealing ring: aluminium	E35063
	Cooling jacket · for infrared temperature sensors TWxxxx, M30 design · for type TW · Housing materials: 304 / 1.4301	E35068



Process sensors

Type	Description	Order no.
	Mounting bracket · Ø 30 mm · for types M30 · Housing materials: Steel galvanised	E35065
	Protective tube · for infrared temperature sensors TWxxxx, M30 design · for type TW · Housing materials: stainless steel	E35066
	Insulating tube · for infrared temperature sensors TWxxxx, M30 design · for type TW · Housing materials: POM	E35067

Accessories

Type	Description	Order no.
	Memory plug · Parameter memory for IO-Link sensors · Storage capacity: 2 Kbytes · Housing materials: PA PACM 12 / PET / sealing: FPM / nut: stainless steel 316L / 1.4404 / connector: TPU	E30398
	Teach button · for sensors PP0xE, PP052x, PP755x · for memory plug (E30398) · 0.9 m · Housing materials: stainless steel / PA / PMMA	E30405
	USB IO-Link master · for parameter setting and analysis of units · Supported communication protocols: IO-Link (4.8, 38.4 and 230 Kbits/s) · for operation with FDT framework software "ifm Container" or software "LINERECORDER SENSOR"	E30390

Software

Type	Description	Order no.
	LR DEVICE (USB stick) · Parameter setting of the units via the network · Software for clear online and offline parameter setting of IO-Link sensors via USB adapter · Use via USB connection cable (drivers are supplied): E30396 IO-Link interface or E30390 IO-Link master (note the respective data sheet) · IODD import and update from ifm's homepage · Reading of IODDs via storage media · Automatic sensor identification · Graphic representation of the process values and history incl. export function · Documentation and archiving · Transferable parameter sets · Full memory plug support for IO-Link 1.1	QA0011
	LR DEVICE (download) · Parameter setting of the units via the network · Software for clear online and offline parameter setting of IO-Link sensors via USB adapter · Use via USB connection cable (drivers are supplied): E30396 IO-Link interface or E30390 IO-Link master (note the respective data sheet) · IODD import and update from ifm's homepage · Reading of IODDs via storage media · Automatic sensor identification · Graphic representation of the process values and history incl. export function · Documentation and archiving · Transferable parameter sets · Full memory plug support for IO-Link 1.1	QA0012

Certificates

Description	Order no.
DAkKS calibration certificate for temperature sensors · Number of measuring points: 3-point DAkKS calibration · Measurement points [°C]: 65, 85, 123 (to directive DAkKS-DKD-R 5-1) · Minimum measurement uncertainty [K]: 0.1	ZC0013
DAkKS calibration certificate for temperature sensors · Number of measuring points: 5-point DAkKS calibration · Measurement points [°C]: 20, 65, 85, 100, 123 (to directive DAkKS-DKD-R 5-1) · Minimum measurement uncertainty [K]: 0.1	ZC0014

Description	Order no.
DAkKS calibration certificate for temperature sensors · Number of measuring points: n-point DAkKS calibration · Measurement points [°C]: number and positions as requested by the customer, maximum 4 points in the range from -20...150 °C (to directive DAkKS-DKD-R 5-1) · Minimum measurement uncertainty [K]: 0.1	ZC0015
Factory calibration certificate for temperature sensors · Number of measuring points: 3-point factory calibration · Measurement points [°C]: 65, 85, 123 (to ISO 9001) · Minimum measurement uncertainty [K]: 0.1	ZC0016
Factory calibration certificate for temperature sensors · Number of measuring points: 5-point factory calibration · Measurement points [°C]: 20, 65, 85, 100, 123 (to ISO 9001) · Minimum measurement uncertainty [K]: 0.1	ZC0017
Factory calibration certificate for temperature sensors · Number of measuring points: n-point factory calibration · Measurement points [°C]: number and positions as requested by the customer, maximum 4 points in the range from -20...150 °C (to ISO 9001) · Minimum measurement uncertainty [K]: 0.1	ZC0018
Factory calibration sheet for first delivery of infrared temperature sensors · TW2000 / TW2001 / TW2002 / TW2011 · Minimum measurement uncertainty [K]: ± 4	ZC0061
Recalibration for infrared temperature sensors · TW2000 / TW2001 / TW2011 · Minimum measurement uncertainty [K]: ± 4	ZC0062
Recalibration for infrared temperature sensors · TW2002 · Minimum measurement uncertainty [K]: ± 4	ZC0063

Thermowells for temperature sensors

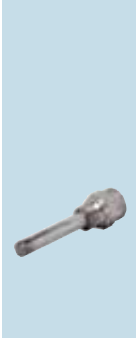
Type	Description	Order no.
	Welding thermowell · Ø 35 mm · for type TA343x, TAA431, TAD191 · stainless steel 316L / 1.4404	E30403
	Thermowell for temperature sensors · G ½ · for type TA34xx, TAA431, TAD191 · stainless steel 316L / 1.4404	E30393
	Thermowell for temperature sensors · G ½ · ½" NPT · for type TA34xx, TAA4xx · stainless steel 316L / 1.4404	E30397
	Thermowell for temperature sensors · Ø 10 mm · G ½ · stainless steel 316L / 1.4404	E35010
	Thermowell for temperature sensors · Ø 10 mm · G ½ · stainless steel 316L / 1.4404	E35020
	Thermowell for temperature sensors · Ø 10 mm · G ½ · stainless steel 316L / 1.4404	E35030
	Thermowell for temperature sensors · Ø 10 mm · G ½ · stainless steel 316L / 1.4404	E35050



Process sensors

Type	Description	Order no.
	Thermowell for temperature sensors · Ø 6 mm · for temperature sensors with installation length EL = 100 mm · stainless steel 316L / 1.4404	E37211
	Thermowell for temperature sensors · Ø 6 mm · for temperature sensors with installation length EL = 150 mm · stainless steel 316L / 1.4404	E37221
	Thermowell for temperature sensors · Ø 6 mm · for temperature sensors with installation length EL = 100 mm · stainless steel 316L / 1.4404	E37810
	Thermowell for temperature sensors · Ø 6 mm · for temperature sensors with installation length EL = 150 mm · stainless steel 316L / 1.4404	E37820
	Thermowell for temperature sensors · Ø 6 mm · for temperature sensors with installation length EL = 300 mm · stainless steel 316L / 1.4404	E37830
	Thermowell for temperature sensors · Ø 6 mm · for temperature sensors with installation length EL = 350 mm · stainless steel 316L / 1.4404	E37850
	Thermowell for temperature sensors · Ø 6 mm · for temperature sensors with installation length EL = 100 mm · stainless steel 316L / 1.4404	E37910
	Thermowell for temperature sensors · Ø 6 mm · for temperature sensors with installation length EL = 150 mm · stainless steel 316L / 1.4404	E37920
	Thermowell for temperature sensors · Ø 6 mm · for temperature sensors with installation length EL = 300 mm · stainless steel 316L / 1.4404	E37930
	Thermowell for temperature sensors · Ø 6 mm · for temperature sensors with installation length EL = 350 mm · stainless steel 316L / 1.4404	E37950
	Thermowell for temperature sensors · Ø 6 mm · for temperature sensors with installation length EL = 50 mm · stainless steel 316Ti / 1.4571	E37603
	Thermowell for temperature sensors · Ø 6 mm · for temperature sensors with installation length EL = 100 mm · stainless steel 316Ti / 1.4571	E37613
	Thermowell for temperature sensors · Ø 6 mm · for temperature sensors with installation length EL = 150 mm · stainless steel 316Ti / 1.4571	E37623
	Thermowell for temperature sensors · Ø 6 mm · for temperature sensors with installation length EL = 250 mm · stainless steel 316Ti / 1.4571	E37643
	Thermowell for temperature sensors · Ø 6 mm · for temperature sensors with installation length EL = 350 mm · stainless steel 316Ti / 1.4571	E37663
	Thermowell for temperature sensors · Ø 6 mm · for temperature sensors with installation length EL = 100 mm · stainless steel 316L / 1.4404	E37511















Type	Description	Order no.
	Thermowell for temperature sensors · Ø 6 mm · for temperature sensors with installation length EL = 150 mm · stainless steel 316L / 1.4404	E37521
	Thermowell for temperature sensors · Ø 6 mm · for temperature sensors with installation length EL = 50 mm · stainless steel 316Ti / 1.4571	E37600
	Thermowell for temperature sensors · Ø 6 mm · for temperature sensors with installation length EL = 100 mm · stainless steel 316Ti / 1.4571	E37610
	Thermowell for temperature sensors · Ø 6 mm · for temperature sensors with installation length EL = 150 mm · stainless steel 316Ti / 1.4571	E37620
	Thermowell for temperature sensors · Ø 6 mm · for temperature sensors with installation length EL = 250 mm · stainless steel 316Ti / 1.4571	E37640
	Thermowell for temperature sensors · Ø 6 mm · for temperature sensors with installation length EL = 50 mm · stainless steel 316Ti / 1.4571	E37700
	Thermowell for temperature sensors · Ø 6 mm · for temperature sensors with installation length EL = 100 mm · stainless steel 316Ti / 1.4571	E37710
	Thermowell for temperature sensors · Ø 6 mm · for temperature sensors with installation length EL = 150 mm · stainless steel 316Ti / 1.4571	E37720
	Welding thermowell for temperature sensors · Ø 6 mm · for temperature sensors with installation length EL = 50 mm · stainless steel 316L / 1.4404	E37411
	Welding thermowell for temperature sensors · Ø 6 mm · for temperature sensors with installation length EL = 100 mm · stainless steel 316L / 1.4404	E37421
	Welding thermowell for temperature sensors · Ø 6 mm · for temperature sensors with installation length EL = 150 mm · stainless steel 316L / 1.4404	E37431
	Welding thermowell for temperature sensors · Ø 6 mm · for temperature sensors with installation length EL = 300 mm · stainless steel 316L / 1.4404	E37430
	Welding thermowell for temperature sensors · Ø 6 mm · for temperature sensors with installation length EL = 350 mm · stainless steel 316L / 1.4404	E37450













Adapters

Type	Description	Order no.
	Thread cover · Ø 24 mm - G ½ · Ø 24 mm · to cover the G½ thread for installation in hygienic areas · for type TR · Housing materials: stainless steel	E30091



Process sensors

Type	Description	Order no.
	Mounting set · for direct connection of temperature sensors TT to control monitors TR · Housing materials: stainless steel	E30017
	Clamp fitting · Ø 6/8/10 mm · G ½ · for temperature sensors · Housing materials: stainless steel / FPM	E30018
	Clamp fitting · Ø 6/8/10 mm · ½" NPT · for temperature sensors · Housing materials: stainless steel / FPM	E30025
	Mounting adapter · M18 x 1.5 - Ø 23 mm · PVC adapter to be glued into the pipe · Insertion depth of the probe of SID, SFD, TN: · 21 mm · Housing materials: PVC	E40148
	Sealing ring · Ø 18 mm / Ø 23 mm · for G ½ sealing cone · Housing materials: sealing ring on sensor side: FKM / sealing ring on process side: PEEK	E43911
	Adapter · M18 x 1.5 - G ½ · Housing materials: stainless steel 316L / 1.4404 / O-ring: FPM (fitted)	E30073
	Clamp adapter · Ø 6 mm · G ½ · no dead space · Housing materials: stainless steel 316L / 1.4404 / rubber ring: PEEK	E30144
	Welding adapter · M18 x 1.5 - Ø 24 mm · Insertion depth of the probe of SID, SFD, TN: · 15 mm · Housing materials: stainless steel 316L / 1.4404	E40124
	Welding adapter · Ø 24.7 mm · for temperature sensors Ø 6 mm · Clamp fitting · Housing materials: stainless steel 316L / 1.4404	E30108
	Welding adapter · Ø 25 mm · for temperature sensors Ø 6 mm · Clamp fitting · Housing materials: stainless steel 316L / 1.4404 / rubber ring: PEEK	E30407
	Progressive ring fitting for temperature sensors · Ø 10 mm · G ½ · Housing materials: stainless steel 316Ti / 1.4571	E30016
	Progressive ring fitting for temperature sensors · Ø 10 mm · ½" NPT · Housing materials: stainless steel 316Ti / 1.4571	E30024
	Progressive ring fitting for temperature sensors · Ø 6 mm · G ½ · Housing materials: stainless steel 316Ti / 1.4571	E30047
	Progressive ring fitting for temperature sensors · Ø 6 mm · ¼" NPT · Housing materials: stainless steel 316Ti / 1.4571	E30049
	Progressive ring fitting for temperature sensors · Ø 6 mm · G ¼ · Housing materials: stainless steel 316Ti / 1.4571	E33431

Type	Description	Order no.
	Adapter · M18 x 1.5 - G 1/2 · Insertion depth of the probe of SID, SFD, TN: · 21 mm · Housing materials: titanium	E40114
	Adapter · M18 x 1.5 - M12 x 1 · Insertion depth of the probe of SID, SFD, TN: · 13.5 mm · Housing materials: titanium	E40128
	Adapter · M18 x 1.5 - L18 · for mounting in T-pieces · Insertion depth of the probe of SID, SFD, TN: · 28.5 mm · Housing materials: nut: stainless steel 316Ti / 1.4571 / adapter: stainless steel 316L / 1.4404 / O-ring: FKM 16 x 1.5 gr 70° Shore A	E40104
	Adapter · M18 x 1.5 - M12 x 1 · Insertion depth of the probe of SID, SFD, TN: · 13.5 mm · Housing materials: stainless steel 316L / 1.4404	E40101
	Adapter · M18 x 1.5 - M12 x 1 · Insertion depth of the probe of SID, SFD, TN: · 13.5 mm · Housing materials: CW614N	E40100
	Adapter · M18 x 1.5 - G 1/4 · Insertion depth of the probe of SID, SFD, TN: · 13.5 mm · Housing materials: stainless steel 316L / 1.4404	E40099
	Adapter · M18 x 1.5 - G 1/4 · Insertion depth of the probe of SID, SFD, TN: · 13.5 mm · Housing materials: CW614N	E40098
	Adapter · M18 x 1.5 - G 1/2 · Insertion depth of the probe of SID, SFD, TN: · 21 mm · Housing materials: stainless steel 316L / 1.4404	E40096
	Adapter · M18 x 1.5 - G 1/2 · Insertion depth of the probe of SID, SFD, TN: · 21 mm · Housing materials: CW614N	E40097
	Adapter · M18 x 1.5 - 1/2" NPT · Insertion depth of the probe of SID, SFD, TN: · 23 mm · Housing materials: stainless steel 316L / 1.4404	E40107
	Adapter · M18 x 1.5 - G 1/2 · Housing materials: stainless steel 316L / 1.4404 / O-ring: FPM (fitted)	E30073
	Protective cover · with lead seal option · for pressure sensors type PK · for temperature sensors type TK · for vibration sensors type VK · Housing materials: PP transparent	E30094











Hygienic adapters

Type	Description	Order no.
Clamp adapter · 1-1.5" · Aseptoflex Vario		
	Clamp adapter · Clamp · 1-1.5" · ISO 2852 · for units with Aseptoflex Vario adapter · Sealing by sealing ring · Housing materials: stainless steel 316L / 1.4435	E33201



Process sensors











Type	Description	Order no.
Clamp adapter · 2" · Aseptoflex Vario		
	Clamp adapter · Clamp · 2" · ISO 2852 · for units with Aseptoflex Vario adapter · Sealing by sealing ring · Housing materials: stainless steel 316L / 1.4435	E33202
Clamp adapter · 1-1.5" · Aseptoflex Vario		
	Clamp adapter · Clamp · 1-1.5" · ISO 2852 · for units with Aseptoflex Vario adapter · Metal to metal seal · Housing materials: stainless steel 316L / 1.4435	E33701
Clamp adapter · 2" · Aseptoflex Vario		
	Clamp adapter · Clamp · 2" · ISO 2852 · for units with Aseptoflex Vario adapter · Metal to metal seal · Housing materials: stainless steel 316L / 1.4435	E33702
Hygienic pipe fitting · DN40 (1.5") · Aseptoflex Vario		
	Pipe fitting · Hygienic pipe fitting · Hygienic pipe fitting · DN40 (1.5") · DIN 11851 · for units with Aseptoflex Vario adapter · Sealing by sealing ring · Housing materials: stainless steel 316L / 1.4435	E33212
Hygienic pipe fitting · DN50 (2") · Aseptoflex Vario		
	Pipe fitting · Hygienic pipe fitting · Hygienic pipe fitting · DN50 (2") · DIN 11851 · for units with Aseptoflex Vario adapter · Sealing by sealing ring · Housing materials: stainless steel 316L / 1.4435	E33213
Hygienic pipe fitting · DN40 (1.5") · Aseptoflex Vario		
	Pipe fitting · Hygienic pipe fitting · Hygienic pipe fitting · DN40 (1.5") · DIN 11851 · for units with Aseptoflex Vario adapter · Metal to metal seal · Housing materials: stainless steel 316L / 1.4435	E33712
Hygienic pipe fitting · DN50 (2") · Aseptoflex Vario		
	Pipe fitting · Hygienic pipe fitting · Hygienic pipe fitting · DN50 (2") · DIN 11851 · for units with Aseptoflex Vario adapter · Metal to metal seal · Housing materials: stainless steel 316L / 1.4435	E33713
Varivent Adapter · Type N, DN40...DN150 (1.5...6"), D = 68 · Aseptoflex Vario		
	Clamp adapter · Varivent Adapter · Varivent type N · DN40...DN150 (1.5...6"), D = 68 · for units with Aseptoflex Vario adapter · Sealing by sealing ring · Housing materials: stainless steel 316L / 1.4435	E33222
	Clamp adapter · Varivent Adapter · Varivent type N · DN40...DN150 (1.5...6"), D = 68 · for units with Aseptoflex Vario adapter · Metal to metal seal · Housing materials: stainless steel 316L / 1.4435	E33722
SMS pipe fitting · DN40 (1.5") · Aseptoflex Vario		
	Pipe fitting · SMS pipe fitting · DN40 (1.5") · SMS · for units with Aseptoflex Vario adapter · Metal to metal seal · Housing materials: stainless steel 316L / 1.4435	E33731



Type	Description	Order no.
SMS pipe fitting · DN50 (2") · Aseptoflex Vario		
	Pipe fitting · SMS pipe fitting · DN50 (2") · SMS · for units with Aseptoflex Vario adapter · Metal to metal seal · Housing materials: stainless steel 316L / 1.4435	E33732
Welding adapter · D50 · Aseptoflex Vario		
	Welding adapter · Ø 50 mm · for units with Aseptoflex Vario adapter · Sealing by sealing ring · Housing materials: stainless steel 316L / 1.4435	E30122
Aseptoflex Vario · Aseptoflex Vario		
	sealing plug · Aseptoflex Vario · Housing materials: adapter: stainless steel 316L / 1.4435 / sealing ring: FKM	E30128
Clamp adapter · 1-1.5" · G ½		
	Clamp adapter · Clamp · 1-1.5" · ISO 2852 / DIN 32676 · for units with G ½ adaptation · Housing materials: stainless steel 316L / 1.4404	E33401
Clamp adapter · 2" · G ½		
	Clamp adapter · Clamp · 2" · ISO 2852 / DIN 32676 · for units with G ½ adaptation · Housing materials: stainless steel 316L / 1.4404	E33402
SMS pipe fitting · DN25 · G ½		
	Pipe fitting · SMS pipe fitting · DN25 · SMS · for units with G ½ adaptation · Housing materials: stainless steel 316L / 1.4404	E33430
Welding adapter · D30 · G ½		
	Welding adapter · G ½ · Ø 30 mm · for tanks · Housing materials: stainless steel 316L / 1.4435	E43300
Welding adapter · D29 · G ½		
	Welding adapter · G ½ · Ø 29 mm · for pipes · Housing materials: stainless steel 316L / 1.4435	E43301
Hygienic pipe fitting · DN25 (1") · G ½		
	Pipe fitting · G ½ · Hygienic pipe fitting · DN25 (1") · DIN 11851 · Housing materials: stainless steel 316L / 1.4435	E43304
Hygienic pipe fitting · DN40 (1.5") · G ½		
	Pipe fitting · G ½ · Hygienic pipe fitting · DN40 (1.5") · DIN 11851 · Housing materials: stainless steel 316L / 1.4435	E43305

You can find wiring diagrams and scale drawings from page 571



Process sensors

Type	Description	Order no.
Varivent Adapter · Type F, DN25 (1"), D = 50 · G ½		
	Clamp adapter · G ½ · Varivent type F · DN25 (1"), D = 50 · Housing materials: stainless steel 316L / 1.4435	E43306
Varivent Adapter · Type N, DN40...DN150 (1.5...6"), D = 68 · G ½		
	Clamp adapter · G ½ · Varivent type N · DN40...DN150 (1.5...6"), D = 68 · Housing materials: stainless steel 316L / 1.4435	E43307
sealing plug · G ½		
	sealing plug · G ½ · Housing materials: stainless steel 316L / 1.4435	E43308
Welding adapter ball · D35 · G ½		
	Welding adapter · G ½ · Ø 35 mm · Housing materials: stainless steel 316L / 1.4404	E30055
Welding adapter collar · D45 · G ½		
	Welding adapter · G ½ · Ø 45 mm · Housing materials: stainless steel 316L / 1.4404	E30056
Welding adapter · D30 · G ½		
	Welding adapter · G ½ · Ø 30 mm · for tanks · with leakage port · with leakage port · Housing materials: stainless steel 316L / 1.4435	E43309
Welding adapter · D29 · G ½		
	Welding adapter · G ½ · Ø 29 mm · for pipes · with leakage port · with leakage port · Housing materials: stainless steel 316L / 1.4435	E43310
Clamp adapter · 1-1.5" · G ½		
	Clamp adapter · G ½ · with leakage port · Clamp · 1-1.5" · ISO 2852 / DIN 32676 · with leakage port · Housing materials: stainless steel 316L / 1.4435	E43311
Clamp adapter · 2" · G ½		
	Clamp adapter · G ½ · with leakage port · Clamp · 2" · ISO 2852 / DIN 32676 · with leakage port · Housing materials: stainless steel 316L / 1.4435	E43312
	Welding mandrel · G ½ · carries away heat during welding · Housing materials: CW614N	E43314

Type	Description	Order no.
Welding adapter collar · D45 · G ½		
	Welding adapter · G ½ · with leakage port · Housing materials: stainless steel 316L / 1.4404	E43315
Welding adapter · D50 · G ½		
	Welding adapter · G ½ · long design for deeper installation · long design for deeper installation · Housing materials: stainless steel 316L / 1.4435	E43319

Wiring diagrams

Core colours

- BK black
- BN brown
- BU blue
- WH white
- GY grey

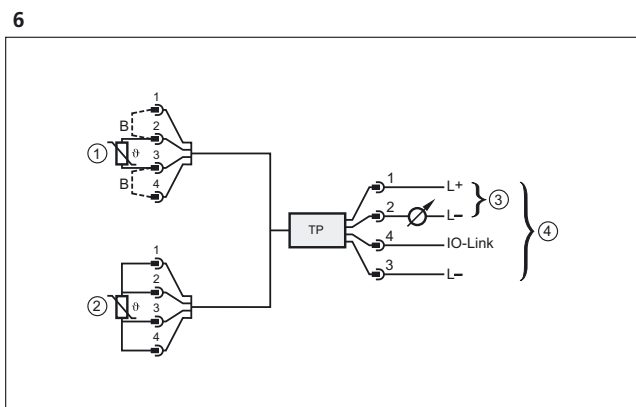
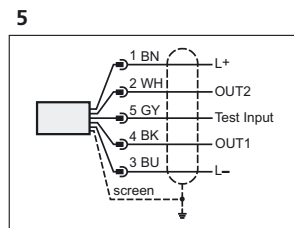
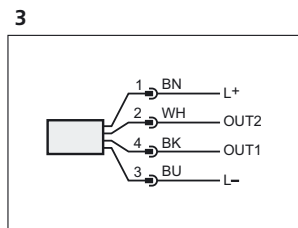
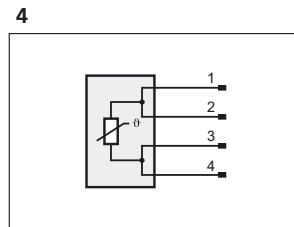
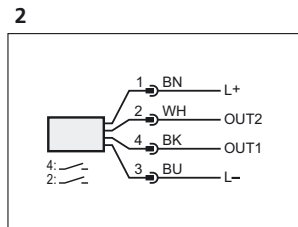
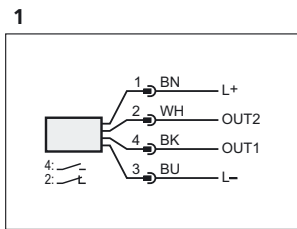

1: Two-wire sensor, 2: Four-wire sensor, 3: Operation as 2-wire temperature transmitter, 4: Operation as 3-wire unit, IO-Link communication possible, B: link

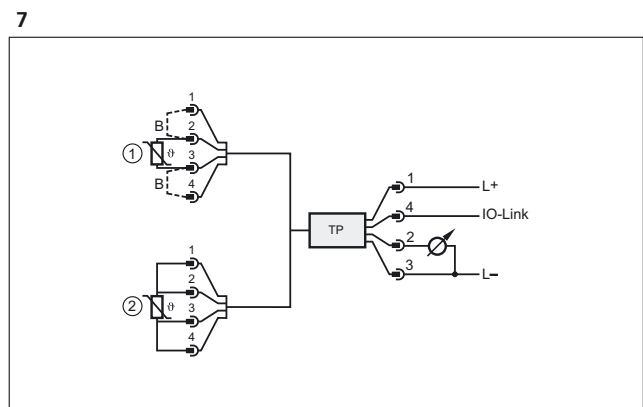

2: Two-wire sensor, 2: Four-wire sensor, B: link

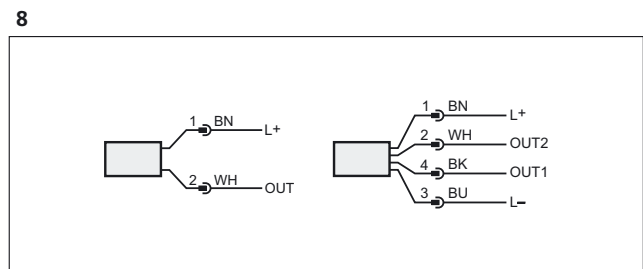



Process sensors

Wiring diagrams

9

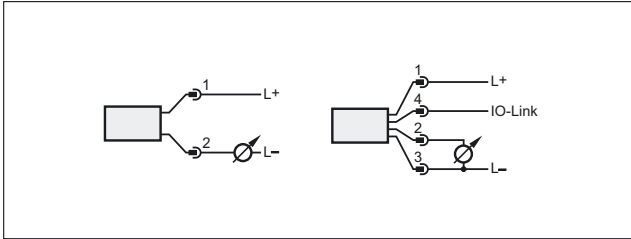

Scale drawings / drawing no. – CAD download: www.ifm.com

1

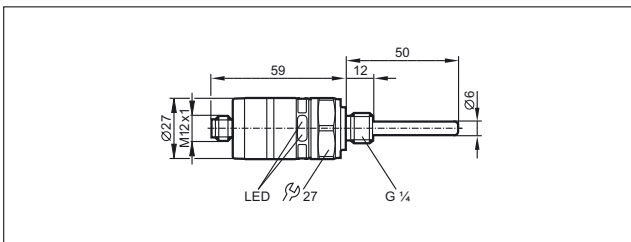

2

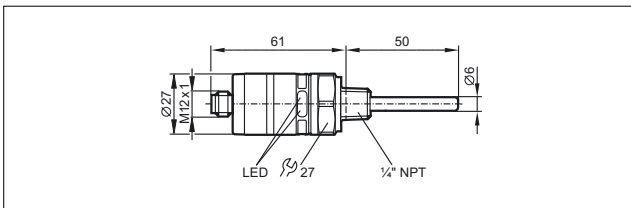

3

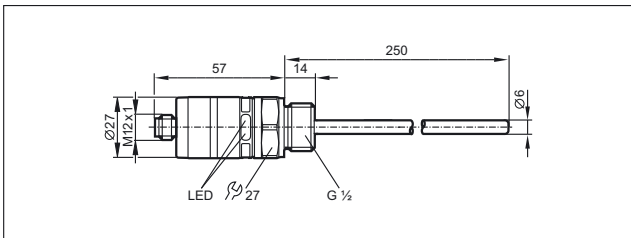

4

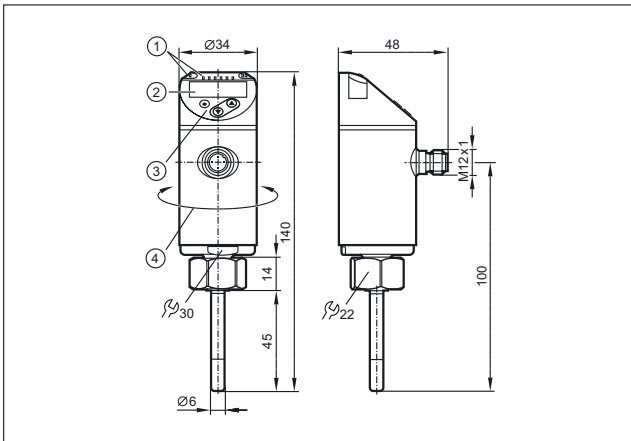

1: LEDs (display unit / switching status), 2: 4-digit alphanumeric display / alternating indication of red and green, 3: Programming buttons, 4: Upper part of the housing can be rotated by 345°

5

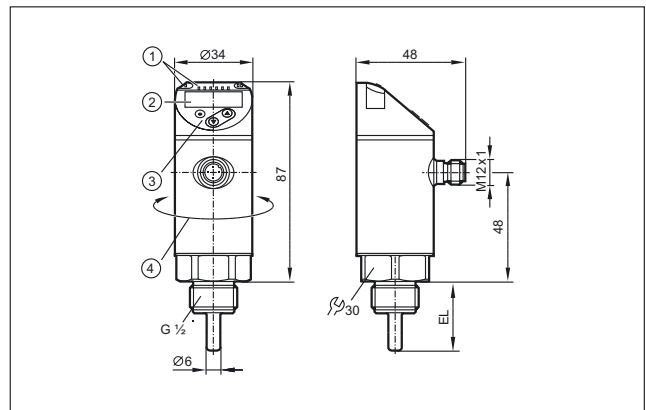

1: LEDs (display unit / switching status), 2: 4-digit alphanumeric display / alternating indication of red and green, 3: Programming buttons, 4: Upper part of the housing can be rotated by 345°

6

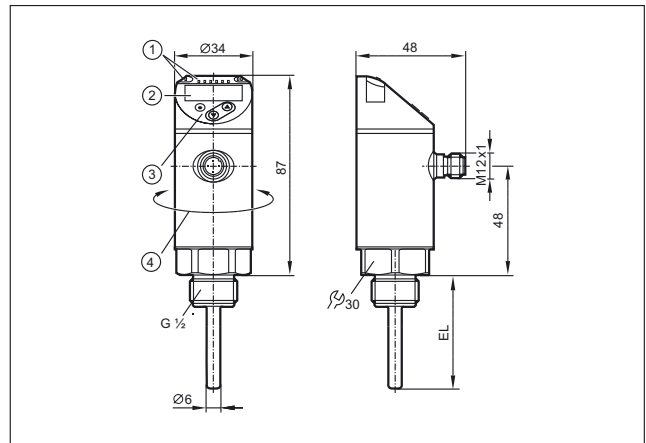

1: LEDs (display unit / switching status), 2: 4-digit alphanumeric display / alternating indication of red and green, 3: Programming buttons, 4: Upper part of the housing can be rotated by 345°

Scale drawings / drawing no. – CAD download: www.ifm.com

7

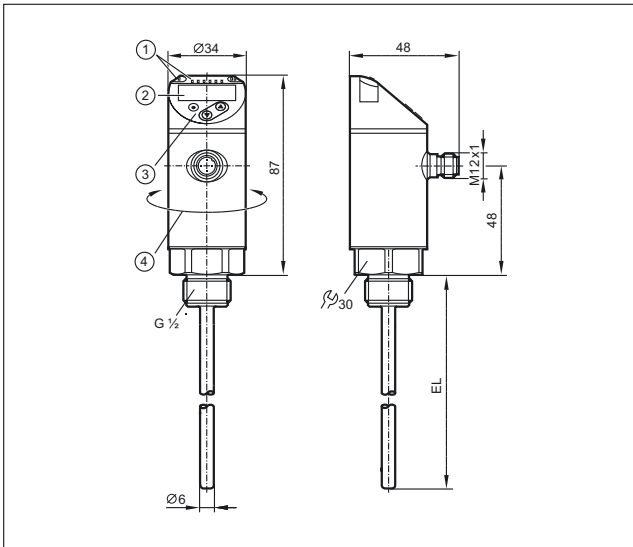

1: LEDs (display unit / switching status), 2: 4-digit alphanumeric display / alternating indication of red and green, 3: Programming buttons, 4: Upper part of the housing can be rotated by 345°

8

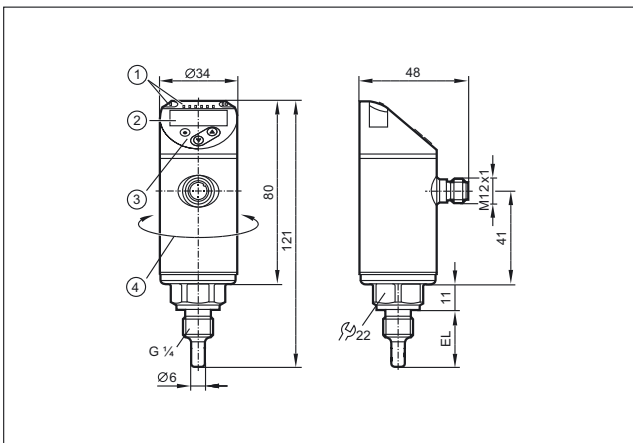

1: LEDs (display unit / switching status), 2: 4-digit alphanumeric display / alternating indication of red and green, 3: Programming buttons, 4: Upper part of the housing can be rotated by 345°

9

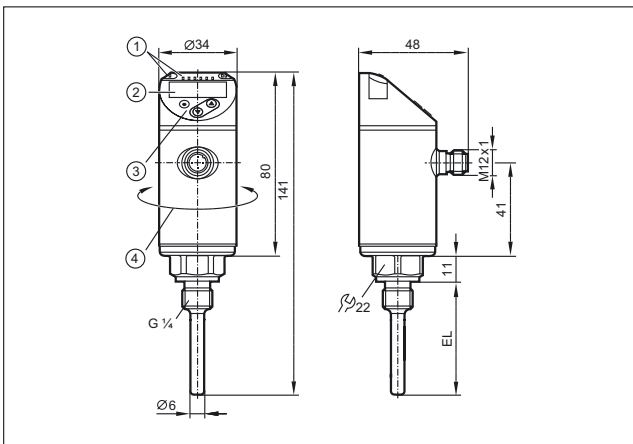

1: LEDs (display unit / switching status), 2: 4-digit alphanumeric display / alternating indication of red and green, 3: Programming buttons, 4: Upper part of the housing can be rotated by 345°

10

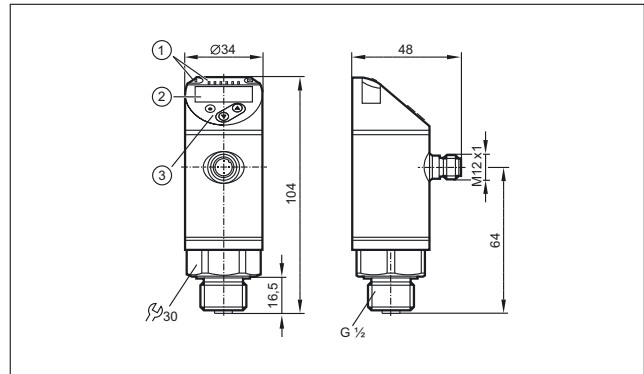

1: LEDs (display unit / switching status), 2: 4-digit alphanumeric display / alternating indication of red and green, 3: Programming buttons

11

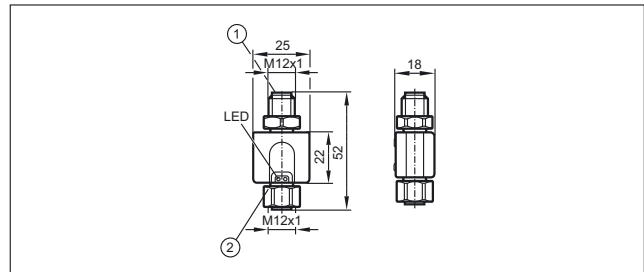

1: connection for voltage supply and output signals, 2: connection for temperature sensor

12

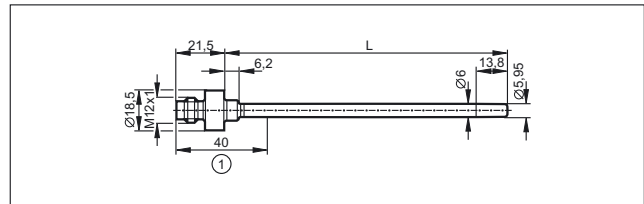

1: plug area, L = probe length (corresponds to installation length EL)

13

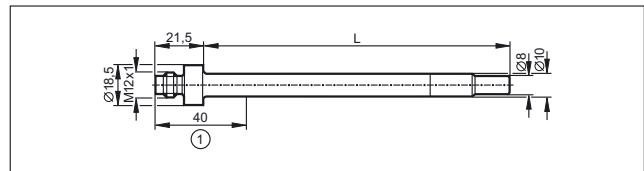

1: plug area, L = probe length (corresponds to installation length EL)

14

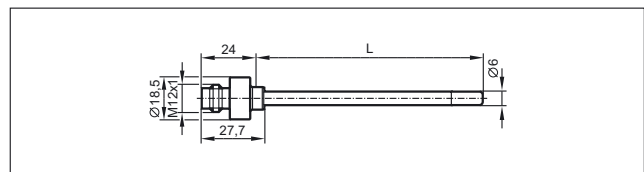

L = probe length (corresponds to installation length EL)



Process sensors

Scale drawings / drawing no. – CAD download: www.ifm.com

15

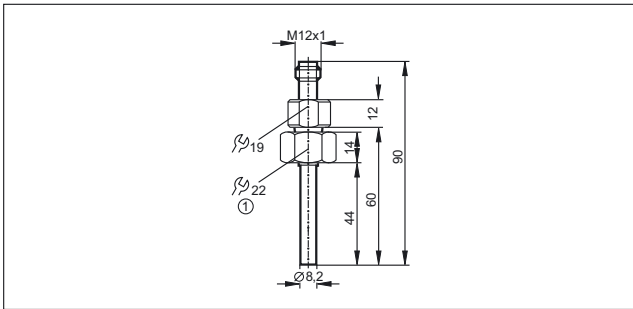

1: internal thread M18 x 1.5

16

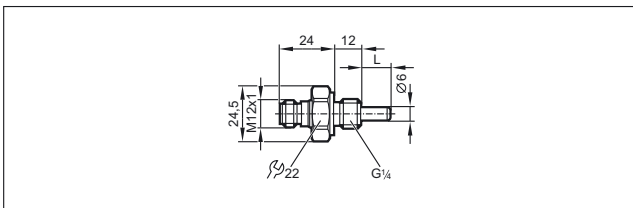

17

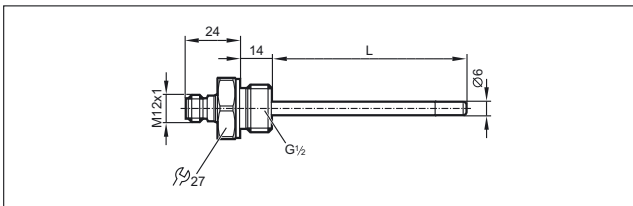

18

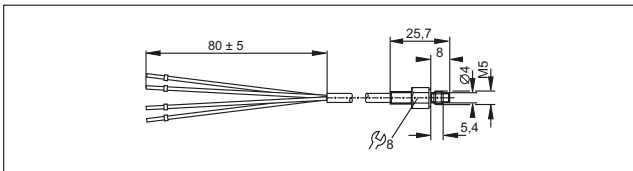

19

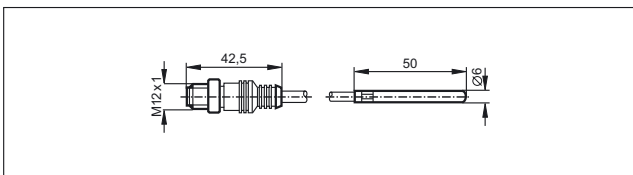

20

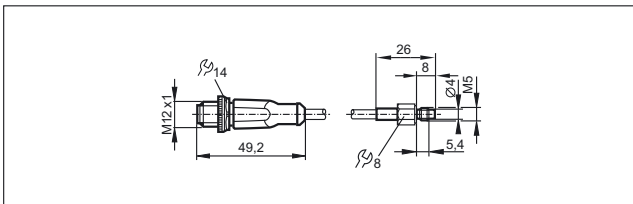

1: tightening torque 1.5 Nm

21

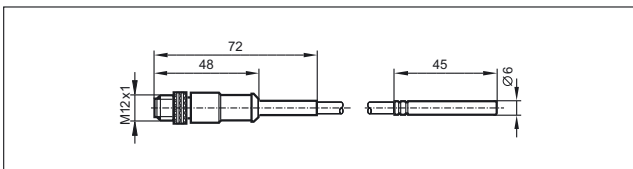

22

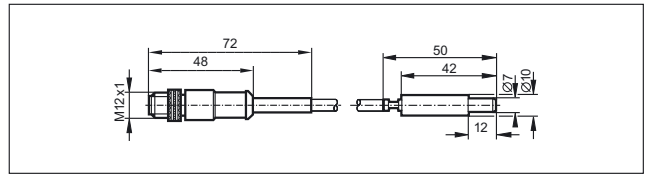

23

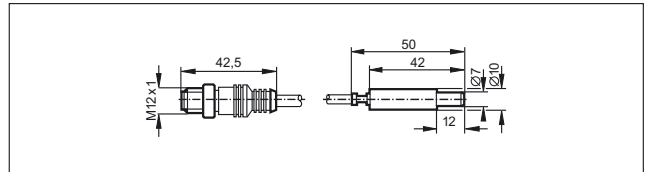

24

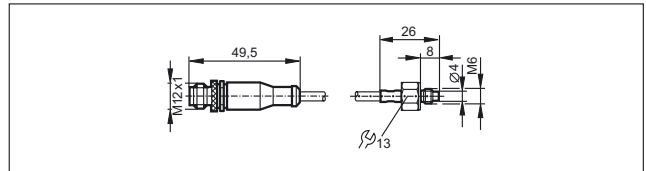

25

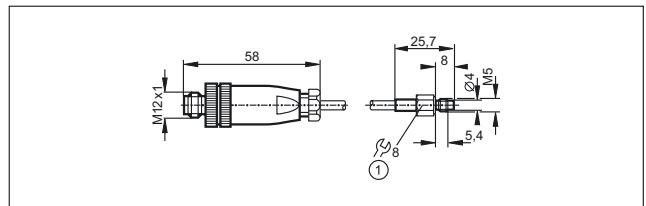

1: tightening torque 1.5 Nm

26

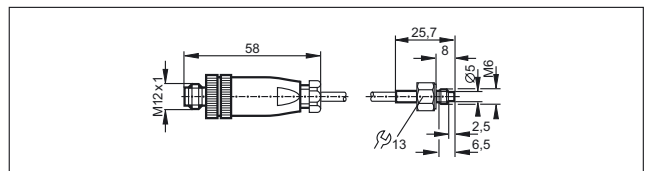

27

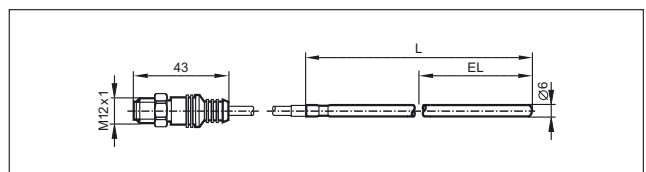

1: connection area, see remark

28

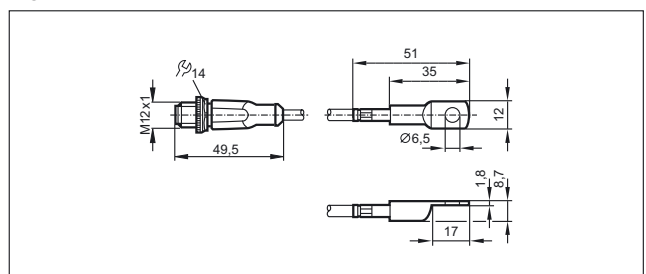

Scale drawings / drawing no. – CAD download: www.ifm.com

29

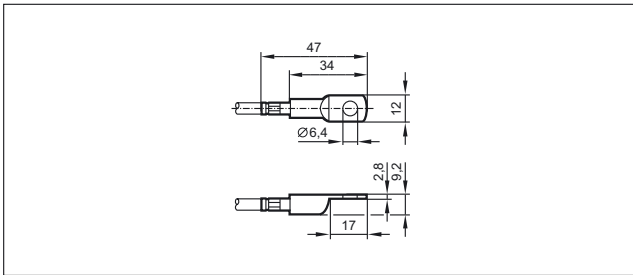

30

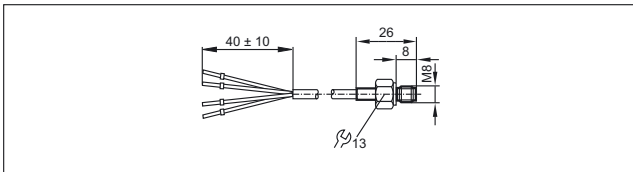

31

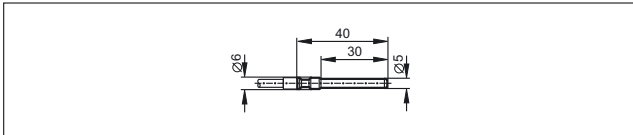

32

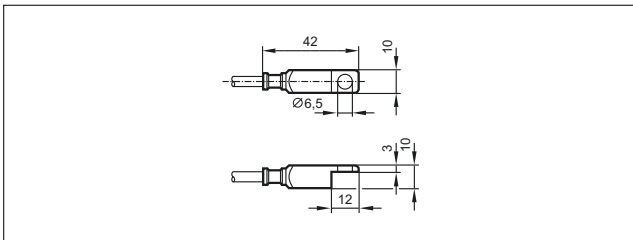

33

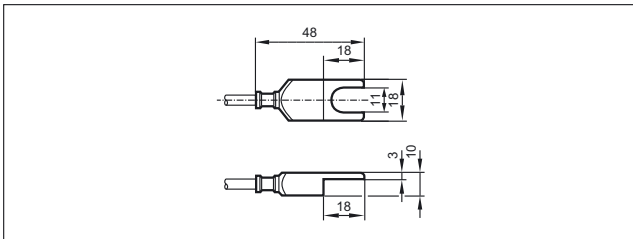

34

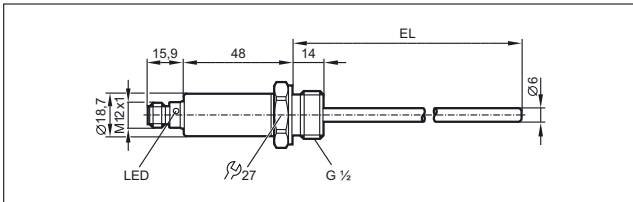

35

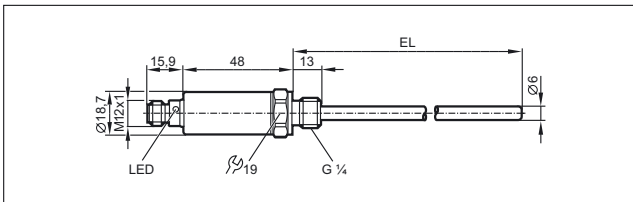

36

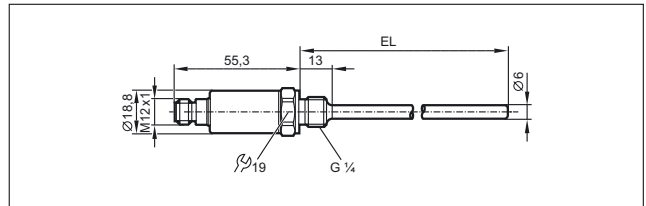

37

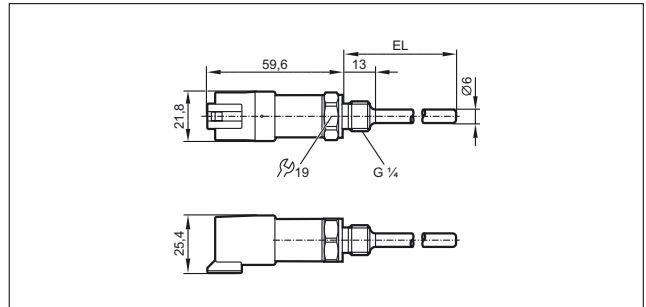

38

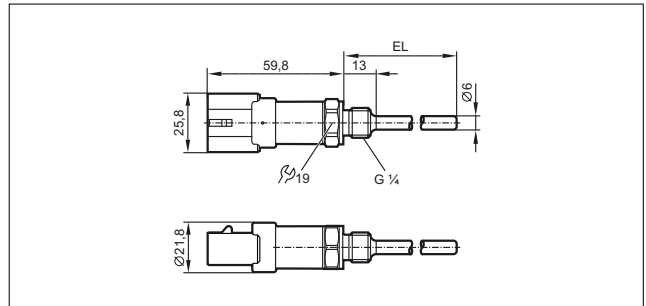

39

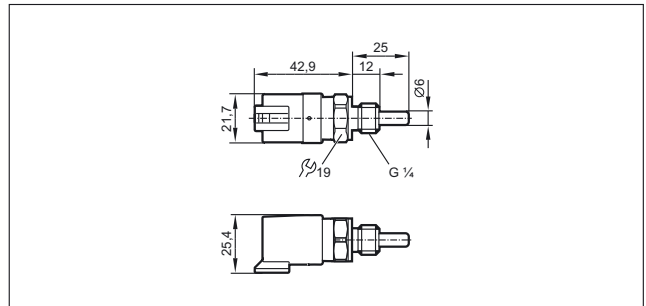

40

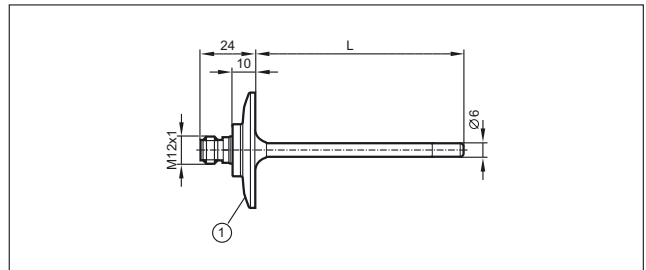

1: 1.5" clamp (ISO 2852), L = probe length (corresponds to installation length EL)



Process sensors

Scale drawings / drawing no. – CAD download: www.ifm.com

41

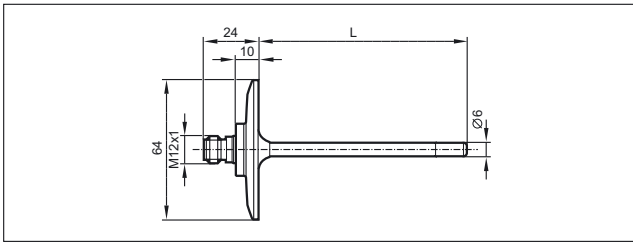

L = probe length (corresponds to installation length EL)

42

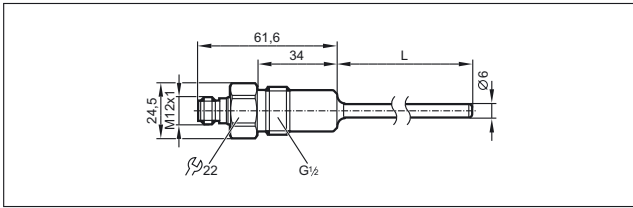

L = probe length (corresponds to installation length EL)

43

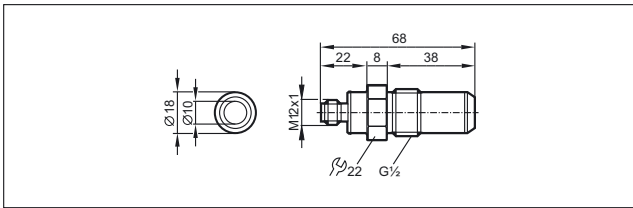

44

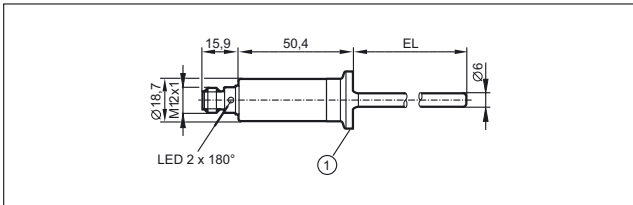

3/4" clamp (ISO 2852)

45

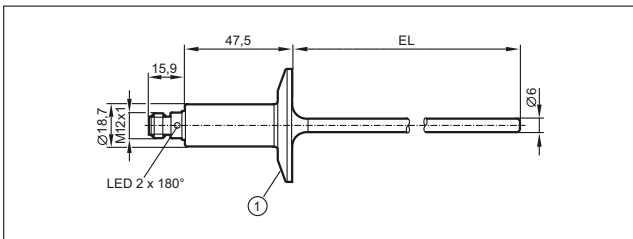

46

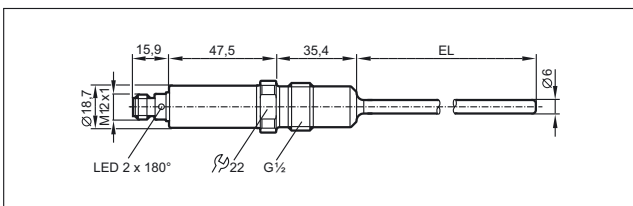

47

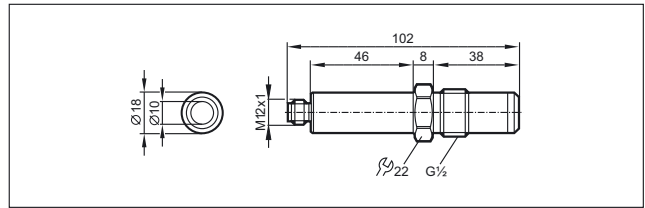

48

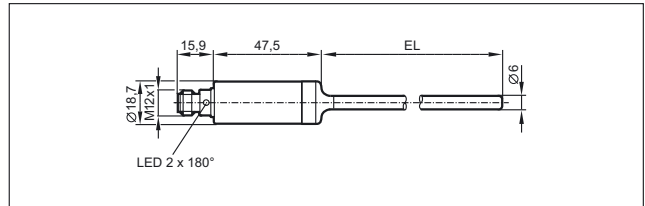

49

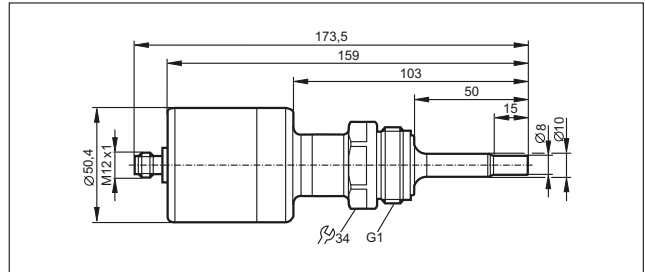

50

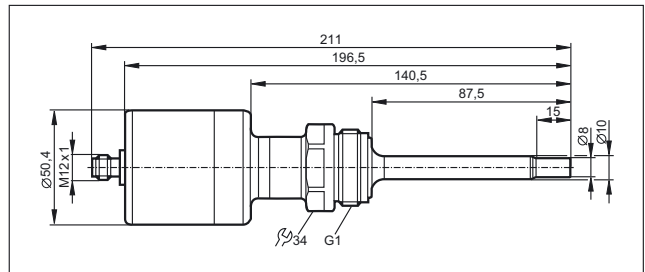

51

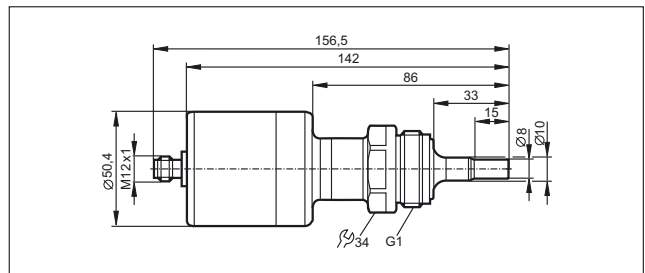

52

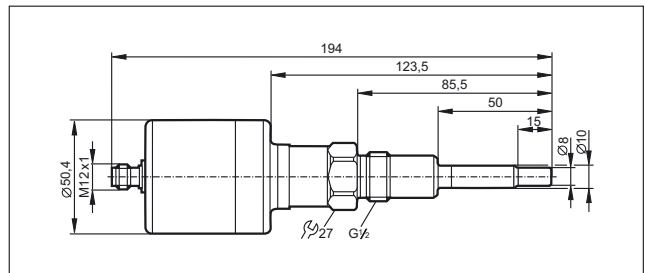

Scale drawings / drawing no. – CAD download: www.ifm.com

53

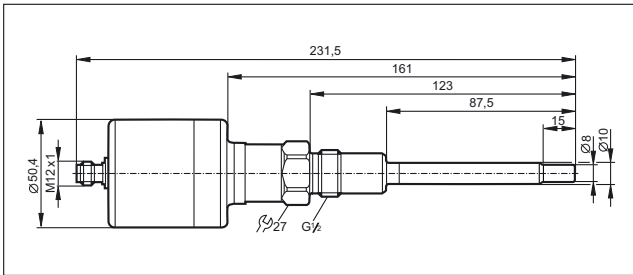

54

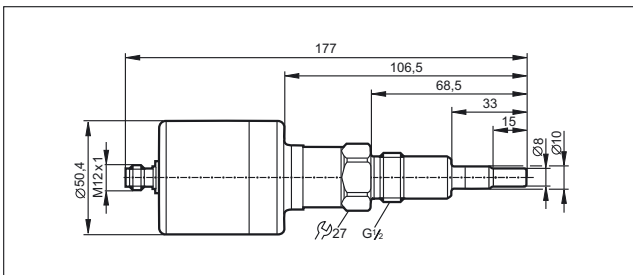

55

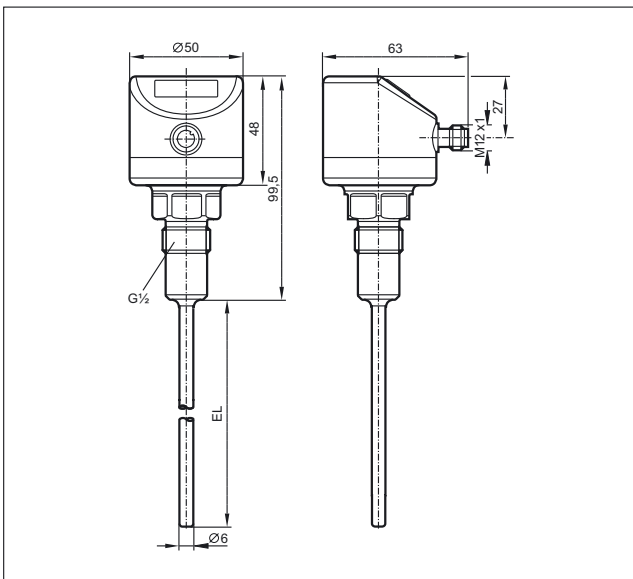

EL = Installation length

56

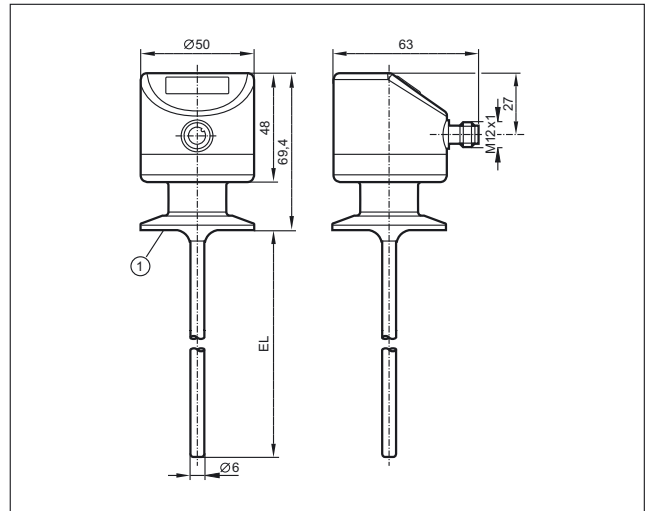

1: 1.5" clamp (ISO 2852), EL = Installation length

57

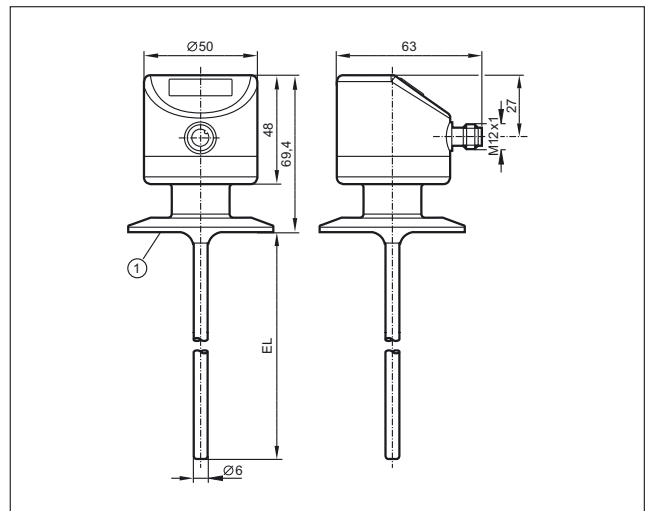

1: 2" clamp (ISO 2852), EL = Installation length

58

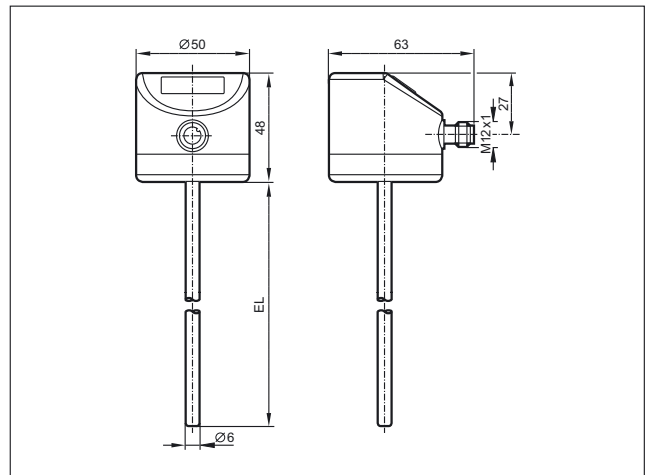

EL = Installation length



Process sensors

Scale drawings / drawing no. – CAD download: www.ifm.com

59

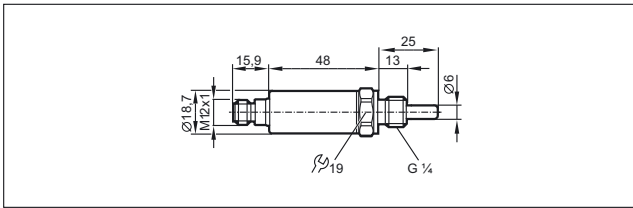

60

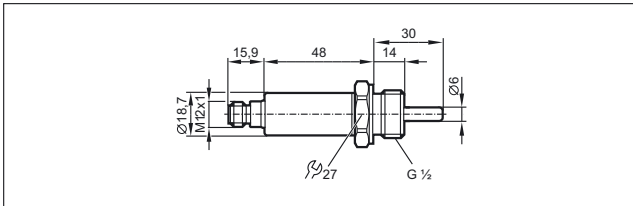

61

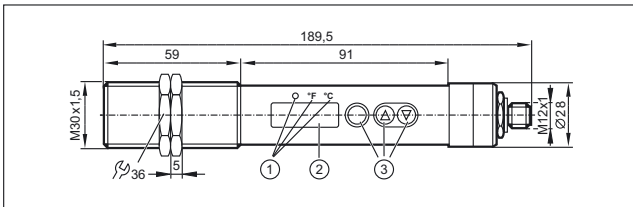

62

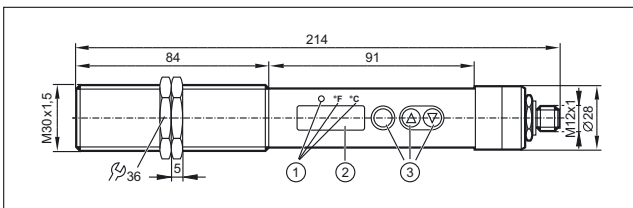

63

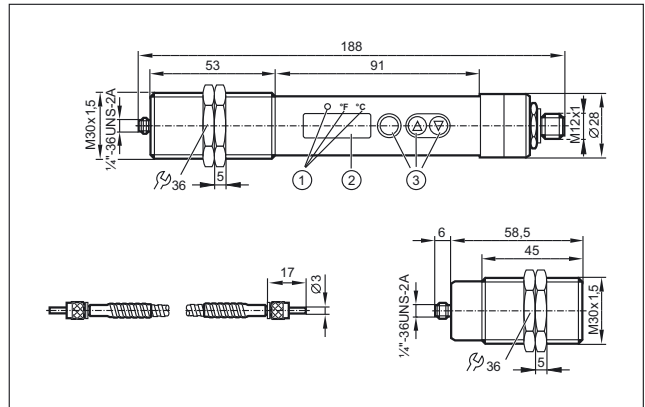

64

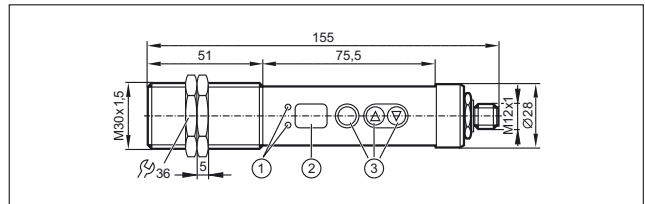

1: Programming buttons, 2: 7-segment LED display

65

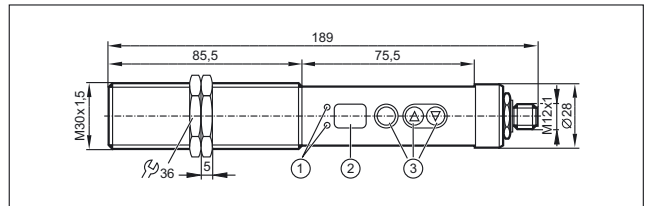

1: LEDs (switching status), 2: 7-segment LED display (2 digits), 3: Programming buttons

66

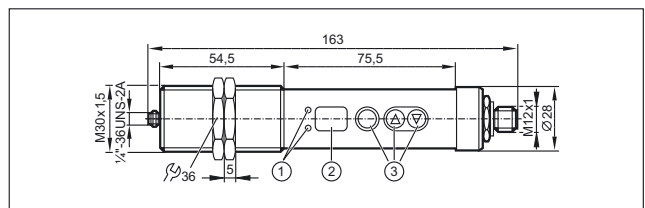

1: LEDs (switching status), 2: 7-segment LED display (2 digits), 3: Programming buttons





Process sensors

User-friendly signal evaluation systems



Signal evaluation systems



Integrated flow, temperature and wire-break monitoring

Adjustable switch points for flow and temperature

Multicolour LED bar graph display for quick setting

Signal output using potential-free relay contacts (changeover contacts)

**Connection options:
Insulation displacement / screw terminals and cage clamps**



Evaluation systems for flow sensors

Various evaluation systems are offered for SF/SP type flow sensors. A multi-coloured LED bar graph indicates the flow. Moreover it is signalled via LEDs and relay outputs when an adjustable medium temperature has been reached or if there is a possible wire break from the sensor to the electronics. The operating elements are on the front. The evaluation systems are available both for AC and for DC supply voltage.







Sensors and control monitors are designed and approved for use in hazardous areas for applications in potentially explosive atmospheres. Wire monitoring between sensor and evaluation system as well as medium-temperature monitoring with optical display and signalling via potential-free relay outputs are also standard.

System overview	Page
Control monitors for industrial applications	582
Control monitors with ATEX approval	582 - 583
Control monitors with ATEX approval 2G	583
Accessories	583
Wiring diagrams	583 - 584
Scale drawings / drawing no. – CAD download: www.ifm.com	585



Process sensors

Control monitors for industrial applications

Type	U _b / Tolerance [V] / [%]	Current consumpt. [mA]	Power consumpt. [VA]	Power-on delay time [s]	Output when flow is present	Output when temperature is exceeded	Output in case of wire break	Drawing no.	Order no.
Combicon connector · Wiring diagram no. 3									
	90...240 AC / -5 / +10	–	4	10...80	relay energised	relay energised	relay de-energised	1	SN0150*
Combicon connector · Wiring diagram no. 4									
	90...240 AC / -5 / +10	–	4	10...80	relay energised	–	relay de-energised	1	SN0151*
Combicon connector · Wiring diagram no. 5									
	24 DC / +10 / -20	90	–	10...80	relay energised	relay energised	relay de-energised	1	SR0150*
Combicon connector · Wiring diagram no. 6									
	24 DC / +10 / -10	90	–	10...80	relay energised	–	relay de-energised	1	SR0153*
M12 connector · Wiring diagram no. 1 · Connector groups 8, 10, 19, 21, 23, 25, 148, 149, 153, 184, 188, 193, 202									
	19...36 DC	70	–	10	no / nc programmable	–	–	2	SR5900
1/2" UNF-Connector · Wiring diagram no. 2 · Connector group 34									
	85...265 AC / -5 / +10	–	< 3.5	10	no / nc programmable	–	–	3	SR5906*

* Note on use of miniature fuses for electrical connection

Miniature fuse to IEC60127-2 sheet 1, ≤ 5 A (fast acting) Recommendation: check the unit for reliable function after a short circuit.

Control monitors with ATEX approval

Type	U _b / Tolerance [V] / [%]	Current consumpt. [mA]	Power consumpt. [VA]	Power-on delay time [s]	Output when flow is present	Output when temperature is exceeded	Output in case of wire break	Drawing no.	Order no.
15 terminals...2.5 mm²									
	230 AC / ± 10	–	5	30	relay energised	–	relay de-energised	4	SN2301*
	110 AC / ± 10	–	5	30	relay energised	–	relay de-energised	4	SN2302*

Type	U _b / Tolerance [V] / [%]	Current consumpt. [mA]	Power consumpt. [VA]	Power-on delay time [s]	Output when flow is present	Output when temperature is exceeded	Output in case of wire break	Drawing no.	Order no.
------	--------------------------------------	------------------------	----------------------	-------------------------	-----------------------------	-------------------------------------	------------------------------	-------------	-----------

15 terminals...2.5 mm²

	24 DC / ± 10	125	–	30	relay energised	–	relay de-energised	4	SR2301*
---	--------------	-----	---	----	-----------------	---	--------------------	---	---------

*** Note on use of miniature fuses for electrical connection**

Miniature fuse to IEC60127-2 sheet 1, ≤ 5 A (fast acting) Recommendation: check the unit for reliable function after a short circuit.

Control monitors with ATEX approval 2G

Type	U _b / Tolerance [V] / [%]	Current consumpt. [mA]	Power consumpt. [VA]	Power-on delay time [s]	Output when flow is present	Output when temperature is exceeded	Output in case of wire break	Drawing no.	Order no.
------	--------------------------------------	------------------------	----------------------	-------------------------	-----------------------------	-------------------------------------	------------------------------	-------------	-----------

15 terminals...2.5 mm² · Wiring diagram no. 7

	24 DC / ± 15	100	–	10	relay energised	–	–	5	SR307A*
--	--------------	-----	---	----	-----------------	---	---	---	---------

*** Note on use of miniature fuses for electrical connection**

Miniature fuse to IEC60127-2 sheet 1, ≤ 5 A (fast acting) Recommendation: check the unit for reliable function after a short circuit.

Accessories

Type	Description	Order no.
------	-------------	-----------

	Combicon connector · with cage clamps 4 poles · Housing materials: current carrying parts: copper alloy tin-plated	E40171
---	--	--------

Wiring diagrams

Core colours

- BN brown
- BU blue
- BK black
- WH white
- GY grey

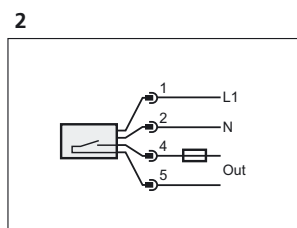
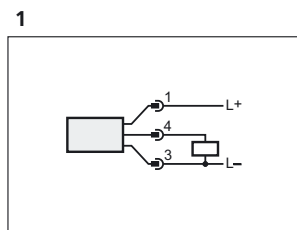



Process sensors

Wiring diagrams

3

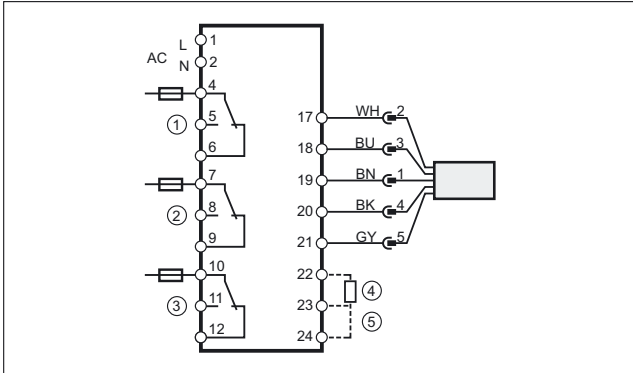

1: Flow monitoring, 2: Wire break monitoring, 3: Temperature monitoring, 4: Power-on delay time, 5: Selection liquid / gas

5

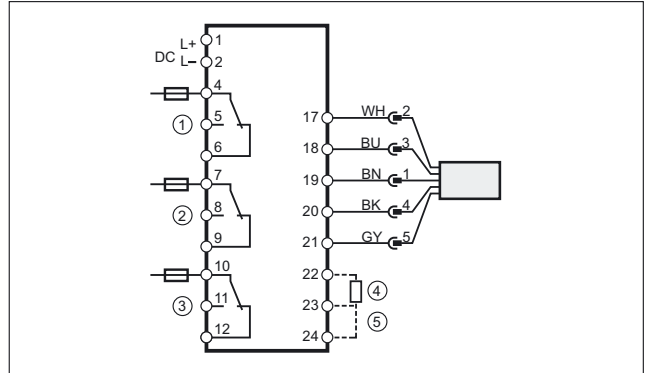

1: Flow monitoring, 2: Wire break monitoring, 3: Temperature monitoring, 4: Power-on delay time, 5: Selection liquid / gas

4

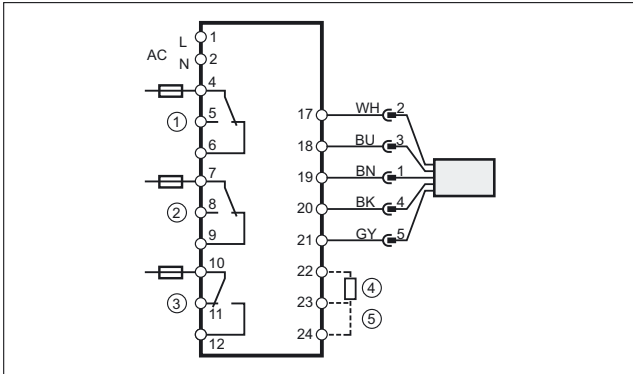

1: Flow monitoring, 2: Wire break monitoring, 3: Temperature monitoring, 4: Power-on delay time, 5: Selection liquid / gas, Note: miniature fuse to IEC60127-2 sheet 1,, ≤ 5 A (fast acting)

6

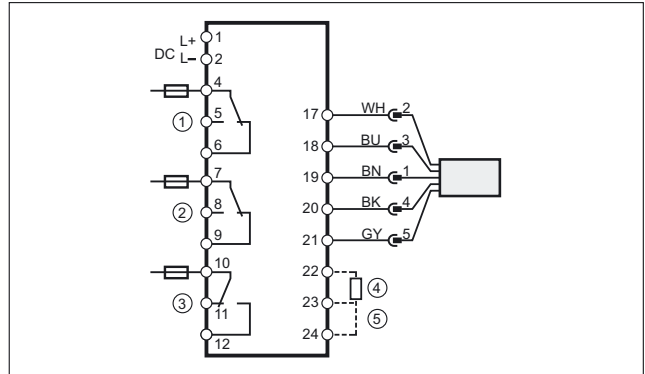

1: Flow monitoring, 2: Wire break monitoring, 3: Temperature monitoring, 4: Power-on delay time, 5: Selection liquid / gas, Note: miniature fuse to IEC60127-2 sheet 1,, ≤ 5 A (fast acting)

7

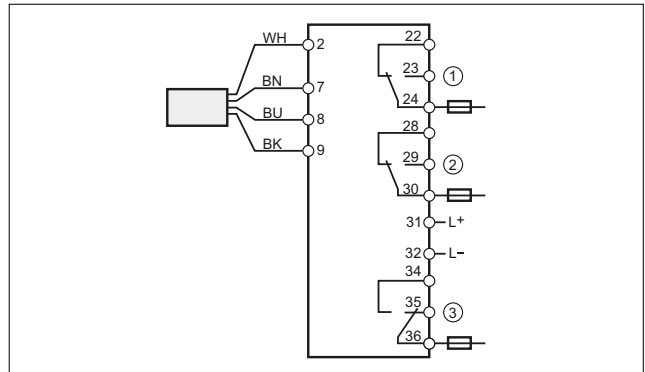

1: Flow monitoring, 2: Fault monitoring, 3: Temperature monitoring, Note: miniature fuse to IEC60127-2 sheet 1,, ≤ 5 A (fast acting), Place the fuse outside the hazardous area.

Scale drawings / drawing no. – CAD download: www.ifm.com

1

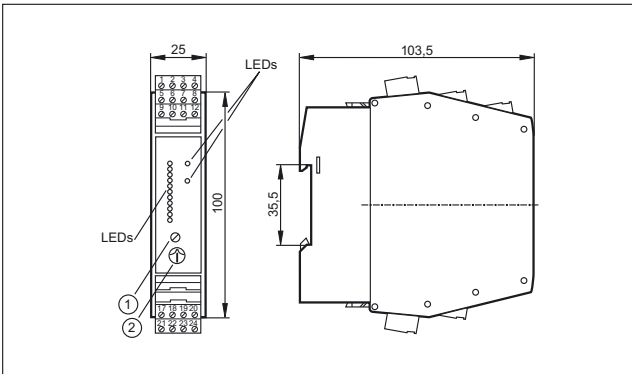

1: Potentiometer (switch point flow), 2: Potentiometer (switch point temperature)

2

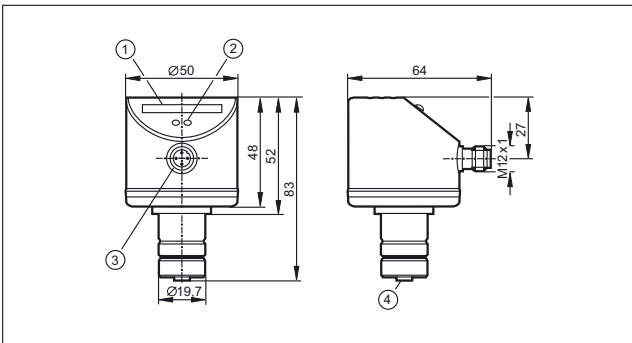

1: LED display, 2: setting pushbutton, 3: connection for voltage supply and output signals, 4: connection for flow sensor

3

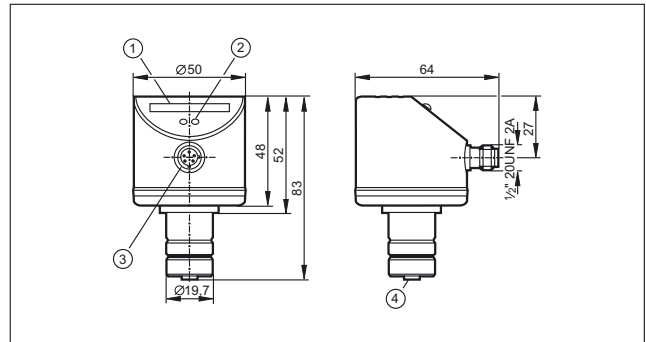

1: LED display, 2: setting pushbutton, 3: connection for voltage supply and output signals, 4: connection for flow sensor

4

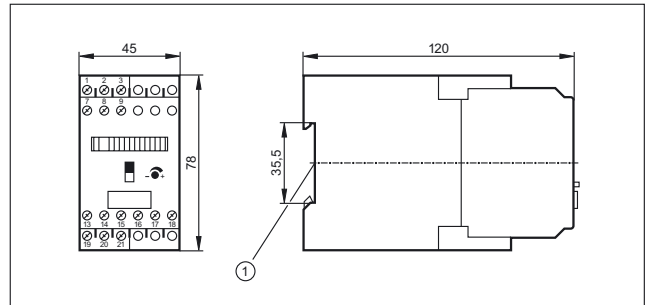

1: Mounting on DIN rail

5

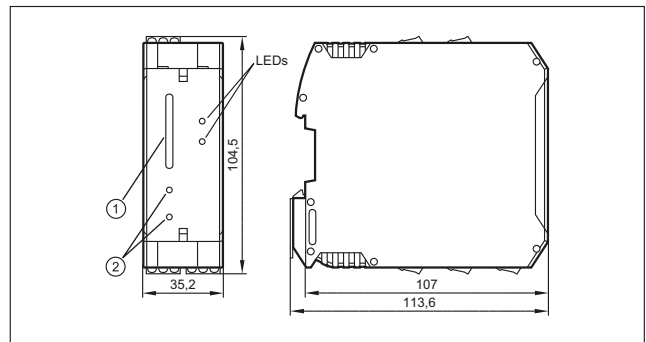

1: LED display, 2: setting pushbuttons



Process sensors

Reliable valve position monitoring



Feedback systems for valves and valve actuators



Dual inductive feedback sensors for pneumatic actuators and valves

Designed for simple fit to common actuators based on VDI / VDE 3845

AS-i valve sensor for quick and safe „plug & play“ installation

Position feedback for rising stem valves up to 80 mm

Permanent valve monitoring for condition-based maintenance

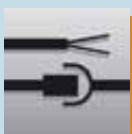
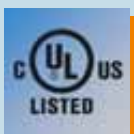
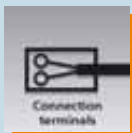

Dual sensor for quarter-turn actuators

A round switching cam, also called "puck", that has at least two metal screws positioned at 90° to each other or a version that is freely adjustable to any angle is mounted to the actuator shaft. The screws are located at a different height. Two inductive sensors detect the upper or lower metal screw depending on the valve position and thus the two switch positions of the actuator. This system operates reliably with no wear at all. It is resistant to external influence and insensitive to mechanical stress such as vibration and shock.

Sensor for rising stem valves











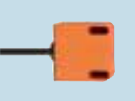







Two or three switch points can be set via pushbuttons over a stroke of 80 mm. Thanks to a resolution of 0.2 mm, the sensor detects even very small changes in the position of the valve. The inductive measuring principle guarantees wear-free non-contact operation.

System overview	Page
Sensors for industrial applications	588 - 589
Sensors for industrial applications, AS-i system	589
Sensors with ATEX approval 1G / 2G and 1D	590
Sensors with ATEX approval 3D and / or 3G	590
Sensors for rising stem valves	591
Sensors for rising stem valves, AS-i system	591
Added value packages with Bürkert solenoid valve	591
Added value packages with Norgren Herion solenoid valve	592
Switching cams for sensors with quarter-turn actuators	592
Accessories for quarter-turn actuator sensors	593
Accessories for rising stem valve sensors	593 - 594
Accessories mounting sets	594
Wiring diagrams	594 - 595
Scale drawings / drawing no. – CAD download: www.ifm.com	596 - 599





Process sensors



Sensors for industrial applications

Type	Dimensions [mm]	Sensing range [mm]	Material	U _b [V]	Protection	f AC / DC [Hz]	I _{load} AC / DC [mA]	Draw- ing no.	Order no.
Cable 2 m · Output function  · AC/DC · Wiring diagram no. 1									
	40 x 26 x 40	4 nf	PBT	20...250	IP 67	25 / 50	250 / 100	1	IN0110*
Terminals · Output function  · AC/DC · Wiring diagram no. 13									
	33 x 60 x 92	4 nf	PA (polyamide)	20...250	IP 67	25 / 50	350 / 100	2	IN0131*
Cable 2 m · Output function  · DC PNP · Wiring diagram no. 2									
	40 x 26 x 26	4 nf	PBT	10...36	IP 67	1300	250	3	IN5251
Cable 6 m · Output function  · DC PNP · Wiring diagram no. 2									
	40 x 26 x 26	4 nf	PC (polycarbonate)	10...36	IP 67	1300	250	3	IN5304
Cable 10 m · Output function  · DC PNP · Wiring diagram no. 2									
	40 x 26 x 26	4 nf	PBT	10...36	IP 67	1300	250	3	IN5323
M12 connector · Output function  · DC PNP/NPN · Wiring diagram no. 14 · Connector groups 8, 10, 19, 21, 23, 25, 148, 149, 153, 184, 188, 193, 202									
	40 x 26 x 26	4 nf	PBT	10...36	IP 67	1300	250	4	IN5224
M12 connector · Output function  · DC PNP/NPN · Wiring diagram no. 3 · Connector groups 8, 10, 19, 21, 23, 25, 148, 149, 153, 184, 188, 193, 202									
	40 x 26 x 47	4 nf	PBT	10...36	IP 67	250	250	5	IN5331
M12 connector · Output function  · DC PNP · Wiring diagram no. 4 · Connector groups 8, 9, 10, 11, 18, 19, 21, 23, 25, 148, 149, 150, 151, 153, 154, 184, 188, 190, 193, 202, 203, 204									
	40 x 26 x 26	4 nf	PBT	10...36	IP 67	1300	250	4	IN5225
	40 x 26 x 47	4 nf	PBT	10...36	IP 67	1300	250	5	IN5327
M18 connector · Output function  · DC PNP · Wiring diagram no. 4 · Connector group 28									
	40 x 26 x 26	4 nf	PBT	10...36	IP 67	1300	250	6	IN5285

Type	Dimensions [mm]	Sensing range [mm]	Material	U _b [V]	Protection	f AC / DC [Hz]	I _{load} AC / DC [mA]	Draw- ing no.	Order no.
------	--------------------	--------------------------	----------	-----------------------	------------	----------------------	--------------------------------------	---------------------	--------------

M18 connector · Output function  /  · AC/DC · Wiring diagram no. 5 · Connector group 28

	40 x 26 x 40	4 nf	PBT	20...250	IP 67	25 / 50	250 / 100	7	IN0108*
---	--------------	------	-----	----------	-------	---------	-----------	---	---------

Rd 24 x 1/8 connector 6 pins · Output function  /  · DC PNP · Connector groups 38, 44, 159, 160

	40 x 26 x 60	4 nf	PBT	10...36	IP 67	1300	250	8	IN5334
---	--------------	------	-----	---------	-------	------	-----	---	--------

Terminals · Output function  /  · DC PNP · Wiring diagram no. 15

	33 x 60 x 92	4 nf	PA (polyamide)	10...30	IP 67	500	100	2	IN5409
---	--------------	------	----------------	---------	-------	-----	-----	---	--------

Terminals · Output function  /  · DC PNP · Wiring diagram no. 16

	33 x 60 x 92	4 nf	PA (polyamide)	10...30	IP 67	500	100	9	IN5410
--	--------------	------	----------------	---------	-------	-----	-----	---	--------

f = flush / nf = non flush / qf = quasi-flush

*** Note on use of miniature fuses for electrical connection**

Miniature fuse to IEC60127-2 sheet 1, ≤ 2 A (fast acting) Recommendation: check the unit for reliable function after a short circuit.

Sensors for industrial applications, AS-i system

Type	Dimensions [mm]	Sensing range [mm]	Material	U _b [V]	Protection	f AC / DC [Hz]	I _{load} AC / DC [mA]	Draw- ing no.	Order no.
------	--------------------	--------------------------	----------	-----------------------	------------	----------------------	--------------------------------------	---------------------	--------------

M12 connector · AS-i · Wiring diagram no. 6 · Connector groups 10, 12, 13, 19, 21, 22, 23, 24, 148, 152, 153, 155, 184, 186, 188, 192, 193, 194, 202, 205

	55 x 60 x 35	4 nf	PBT (Pocan)	26.5...31.6	IP 67	–	–	10	AC2315
---	--------------	------	-------------	-------------	-------	---	---	----	--------

M12 connector · Output function transistor PNP · AS-i · Wiring diagram no. 6 · Connector groups 8, 10, 19, 21, 23, 25, 44, 148, 149, 153, 159, 160, 184, 188, 193, 202

	55 x 60 x 35	4 nf	PBT (Pocan)	26.5...31.6	IP 67	–	100	11	AC2316
---	--------------	------	-------------	-------------	-------	---	-----	----	--------

M12 connector · Output function transistor PNP · 2 inputs / 2 outputs · Connector groups 8, 10, 19, 21, 23, 25, 44, 148, 149, 153, 159, 160, 184, 188, 193, 202

	55 x 60 x 35	4 nf	PBT (Pocan)	26.5...31.6	IP 67	–	–	11	AC2317
---	--------------	------	-------------	-------------	-------	---	---	----	--------

f = flush / nf = non flush / qf = quasi-flush



Process sensors

Sensors with ATEX approval 1G / 2G and 1D

Type	Dimensions [mm]	Sensing range [mm]	Material	U _{nom.} at 1 KΩ [V]	U _b [V]	Internal capacit. [nF]	Internal inductance [μH]	f [Hz]	Draw- ing no.	Order no.
------	--------------------	--------------------------	----------	-------------------------------------	-----------------------	------------------------------	--------------------------------	-----------	---------------------	--------------

Cable 2 m · Output function 2 x normally closed · Connection to certified intrinsically safe circuits with the max. values U = 15 V / I = 50 mA / P = 120 mW · Wiring diagram no. 7

	40 x 26 x 26	4 nf	PBT	8.2 DC	7.5...15 DC	140	130	1800	3	NN5009
---	--------------	------	-----	--------	-------------	-----	-----	------	---	--------

Cable 10 m · Output function 2 x normally closed · Connection to certified intrinsically safe circuits with the max. values U = 15 V / I = 50 mA / P = 120 mW · Wiring diagram no. 7

	40 x 26 x 26	4 nf	PBT	8.2 DC	7.5...15 DC	140	140	1800	3	NN5011
---	--------------	------	-----	--------	-------------	-----	-----	------	---	--------

M12 connector · Output function 2 x normally closed · Connection to certified intrinsically safe circuits with the max. values U = 15 V / I = 50 mA / P = 120 mW · Wiring diagram no. 8 · Connector group 195

	40 x 26 x 26	4 nf	PBT	8.2 DC	7.5...15 DC	140	130	1800	12	NN5008
---	--------------	------	-----	--------	-------------	-----	-----	------	----	--------

M18 connector · Output function 2 x normally closed · Connection to certified intrinsically safe circuits with the max. values U = 15 V / I = 50 mA / P = 120 mW · Wiring diagram no. 9 · Connector group 28

	40 x 26 x 26	4 nf	PBT	8.2 DC	7.5...15 DC	140	130	1800	6	NN5013
---	--------------	------	-----	--------	-------------	-----	-----	------	---	--------

Terminals · Output function 2 x normally closed · Connection to certified intrinsically safe circuits with the max. values U = 15 V / I = 50 mA / P = 120 mW · Wiring diagram no. 17

	33 x 60 x 92	4 nf	PA (polyamide)	8.2 DC	7.5...15 DC	–	–	500	2	NN504A
---	--------------	------	----------------	--------	-------------	---	---	-----	---	--------

Terminals · Output function 2 x normally closed · Connection to certified intrinsically safe circuits with the max. values U = 15 V / I = 50 mA / P = 120 mW · Wiring diagram no. 18 · Connector group --

	33 x 60 x 92	4 nf	PA (polyamide)	8.2 DC	7.5...15 DC	–	–	500	9	NN505A
---	--------------	------	----------------	--------	-------------	---	---	-----	---	--------

f = flush / nf = non flush / qf = quasi-flush

Sensors with ATEX approval 3D and / or 3G

Type	Dimensions [mm]	Sensing range [mm]	Material	U _b [V]	Protection	f AC / DC [Hz]	I _{load} AC / DC [mA]	Draw- ing no.	Order no.
------	--------------------	--------------------------	----------	-----------------------	------------	----------------------	--------------------------------------	---------------------	--------------

M12 connector · Output function transistor PNP · 2 inputs / 1 output · Connector groups 196, 198

	55 x 60 x 35	4	PBT (Pocan)	26.5...31.6	IP 67	–	–	13	AC326A
---	--------------	---	-------------	-------------	-------	---	---	----	--------

M12 connector · Output function  · DC PNP · Wiring diagram no. 4 · Connector groups 196, 198

	40 x 26 x 47	4	PBT	10...30	IP 67	1300	100	14	IN507A
---	--------------	---	-----	---------	-------	------	-----	----	--------

Sensors for rising stem valves

Type	Dimensions [mm]	Sensing range [mm]	Material	U _b [V]	Protection	f AC / DC [Hz]	I _{load} AC / DC [mA]	Drawing no.	Order no.
------	--------------------	-----------------------	----------	-----------------------	------------	----------------------	--------------------------------------	----------------	--------------



Cable 2 m · Output function 1...5 V analogue · DC · Wiring diagram no. 10

	67.5 x 43 x 110	–	PA	18...36	IP 65 / IP 67	–	–	15	IX5002
---	-----------------	---	----	---------	---------------	---	---	----	--------

Cable 2 m · Output function 3 x normally open · DC PNP · Wiring diagram no. 11

	67.5 x 43 x 110	–	PA	18...36	IP 65 / IP 67	–	100	16	IX5006
---	-----------------	---	----	---------	---------------	---	-----	----	--------

Cable with connector 0.3 m · Output function 3 x normally open · DC PNP · Wiring diagram no. 12 · Connector groups 152, 155, 186, 192, 194, 205

	65 x 52 x 110	–	PA	18...36	IP 65 / IP 67	–	100	17	IX5010
	65 x 43 x 110	0.2	PA	18...36	IP 65 / IP 67	–	100	18	ZZ0214



Sensors for rising stem valves, AS-i system

Type	Dimensions [mm]	Sensing range [mm]	Material	U _b [V]	Protection	f AC / DC [Hz]	I _{load} AC / DC [mA]	Drawing no.	Order no.
------	--------------------	-----------------------	----------	-----------------------	------------	----------------------	--------------------------------------	----------------	--------------

Cable with connector 0.15 m · AS-i · Wiring diagram no. 6 · Connector groups 10, 12, 13, 19, 21, 22, 23, 24, 148, 152, 153, 155, 184, 186, 188, 192, 193, 194, 202, 205

	65 x 52 x 110	–	PA	26.5...31.6	IP 65 / IP 67	–	–	17	IX5030
---	---------------	---	----	-------------	---------------	---	---	----	--------



Added value packages with Bürkert solenoid valve

Type	Description	Order no.
	Added value package AS-i for pneumatic quarter-turn actuators · A/B slave · Shaft height 20 mm · Hole spacing 80 mm · Connector	AC0017
	Added value package AS-i for pneumatic quarter-turn actuators · A/B slave · Shaft height 30 mm · Hole spacing 80 mm · Connector	AC0019
	Added value package AS-i for pneumatic quarter-turn actuators · A/B slave · Shaft height 30 mm · Hole spacing 130 mm · Connector	AC0020











Process sensors

Added value packages with Norgren Herion solenoid valve

Type	Description	Order no.
	Added value package AS-i for pneumatic quarter-turn actuators · A/B slave · Shaft height 20 mm · Hole spacing 80 mm · Connector	AC0021
	Added value package AS-i for pneumatic quarter-turn actuators · A/B slave · Shaft height 30 mm · Hole spacing 80 mm · Connector	AC0022
	Added value package AS-i for pneumatic quarter-turn actuators · A/B slave · Shaft height 30 mm · Hole spacing 130 mm · Connector	AC0023





Switching cams for sensors with quarter-turn actuators

Type	Description	Order no.
	Target puck · Ø 53 mm · adjustable · Housing materials: Target puck: PA 6 black / Metal parts: stainless steel	E12516
	Target puck · Ø 53 mm · Housing materials: Target puck: PA 6 black / Metal parts: stainless steel	E12517
	Target puck · Ø 55 mm · Inverted function · Housing colour: black · Housing materials: Target puck: PVC / screws: high-grade stainless steel / Metal ring: stainless steel	E17205
	Target puck · Ø 102 mm · adjustable target screws · Housing colour: black · Housing materials: Target puck: PVC / screws: stainless steel 316Ti / 1.4571	E17119
	Target puck · Ø 102 mm · 3 possible switching flag positions · Housing colour: black · Housing materials: Target puck: PA 6 / screws: V2A	E17328
	Target puck · Ø 102 mm · Housing colour: black · 8 possible switching flag positions · Housing materials: Target puck: PA 6 / screws: V2A	E17329
	direction indicator black · 12 x 4.8 · For target puck · Housing materials: POM	E17295
	direction indicator yellow · 12 x 4.8 · For target puck · Housing materials: POM	E17296
	Spacer · Housing materials: PA 6 black / screw: stainless steel	E12526

Accessories for quarter-turn actuator sensors

Type	Description	Order no.
	Spacer · 10 mm · for compensation between target pucks and dual sensor IND · Housing materials: PBT	E10579
	Spacer · 3 mm · for compensation between target pucks and dual sensor IND · Housing materials: PBT	E10584
	Spacer · 5 mm · for compensation between target pucks and dual sensor IND · Housing materials: PBT	E10585
	Cable gland · M20 x 1.5 · Housing materials: PA 6.6	E12208
	Protective cap · M20 x 1.5 · Housing materials: PA 6.6	E12209
	Plug for covering the oblong holes · Housing materials: EPDM	E12212
	reinforcement bracket · for type IND · Housing materials: stainless steel 316Ti / 1.4571	E11310
	protective housing · Accessory for valve sensors · for type IND · Housing materials: stainless steel	E11984
	Mounting kit · MS-MEC-KU-RA--F04A · for ball valve Mecafrance ISO5211/F04 DN25 PN40 · Detection of the "ON/OFF" position by means of the IND dual sensor	E10597



Accessories for rising stem valve sensors

Type	Description	Order no.
	Mounting adapter · for Alfa Laval valves type SSV (Single Seat Valves) · accessory for IX5010, IX5030 · Housing materials: adapter: PA 6 / target: stainless steel 316L / 1.4404 / screws: stainless steel / clamping device: stainless steel	E12470
	Mounting adapter · for Alfa Laval valves type LKLA-T (Butterfly Valves) · accessory for IX5010, IX5030 · Housing materials: adapter: PA 6 / clamping device: stainless steel / target: stainless steel 316L / 1.4404 / screw: stainless steel / sealing: EPDM	E12476
	Mounting adapter · for SPX/APV valves type single seat valves · accessory for IX5010, IX5030 · Housing materials: flange: high-grade stainless steel / spacer: POM / target: stainless steel 316L / 1.4404	E12515
	Mounting adapter · for SPX/APV valves type butterfly valves · accessory for IX5010, IX5030 · Housing materials: flange: high-grade stainless steel / spacer: POM / target: stainless steel 316L / 1.4404 / sealing: FPM Shore hardness A 80° C	E12501

You can find wiring diagrams and scale drawings from page 594



Process sensors

Type	Description	Order no.
	Mounting adapter · for GEA single-seat valves · accessory for IX5010, IX5030 · Housing materials: adapter: PA 6 / target: stainless steel 316L / 1.4404	E12478
	Mounting adapter · for Bardiani valves · accessory for IX5010, IX5030 · Housing materials: adapter: PA / target: stainless steel 316L / 1.4404	E12170

Accessories mounting sets

Type	Description	Draw- ing no.	Order no.
	Mounting set · for type IND, INE · Housing materials: Mounting plate: plastics / Metal parts: stainless steel	19	E12519
	Mounting set · for type IND, INE · Housing materials: Mounting plate: plastics / Metal parts: stainless steel	20	E12520
	Mounting set · for type IND, INE · Housing materials: Mounting plate: plastics / Metal parts: stainless steel	21	E12521
	Mounting set · for type IND, INE · Housing materials: Mounting plate: plastics / Metal parts: stainless steel	22	E12522
	Mounting set · for type IND, INE · Housing materials: Mounting plate: plastics / Metal parts: stainless steel	23	E12523
	Mounting set · for type IND, INE · Housing materials: Mounting plate: plastics / Metal parts: stainless steel	24	E12524

Wiring diagrams

Core colours

BN brown
 BU blue
 BK black
 WH white
 GY grey

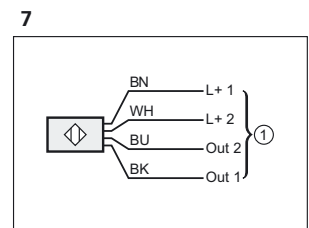
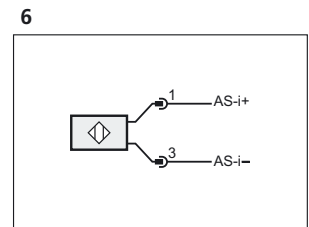
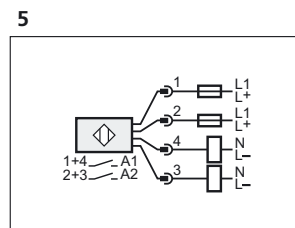
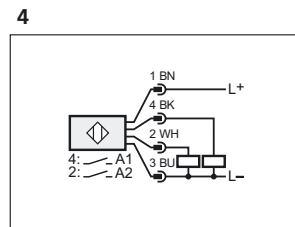
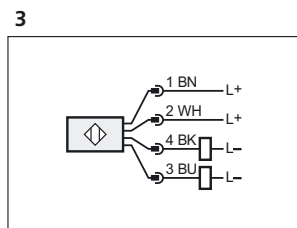
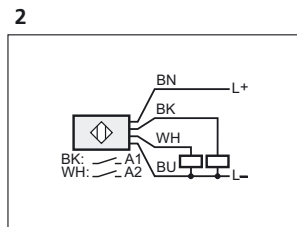
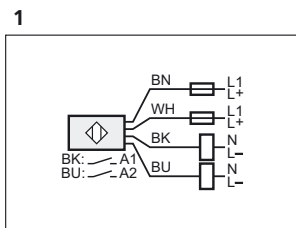

1: connection to NAMUR-amplifier

Wiring diagrams

8

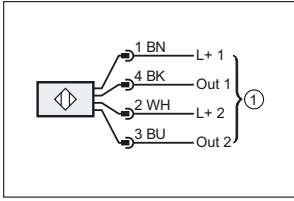

1: connection to NAMUR-amplifier

9

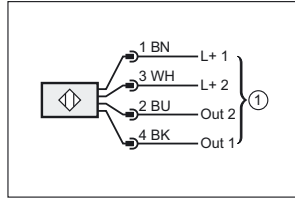

1: connection to NAMUR-amplifier

10

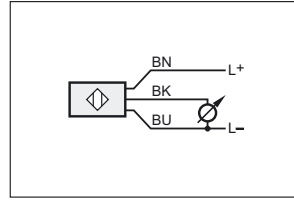

12

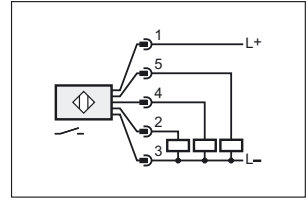

11

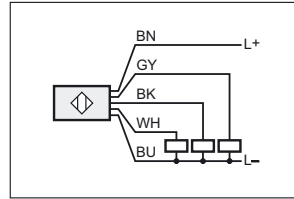

13

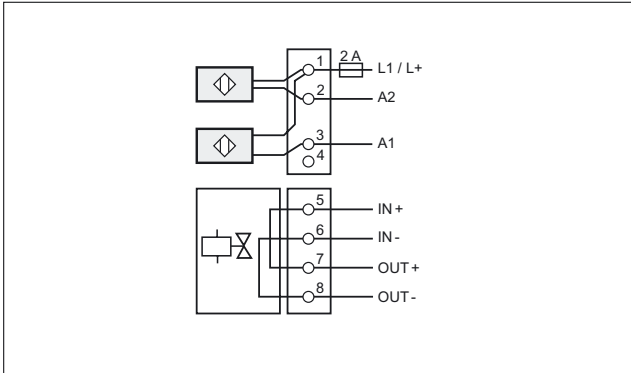

16

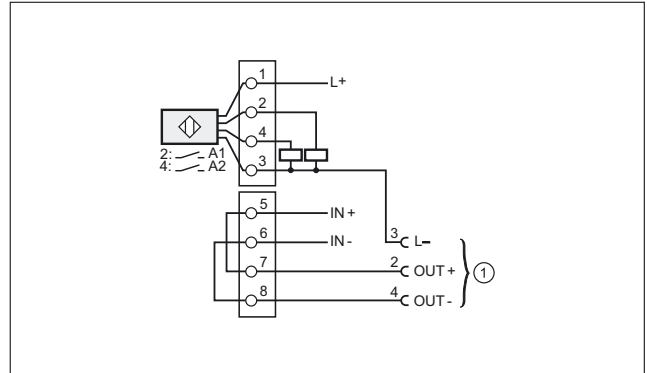

14

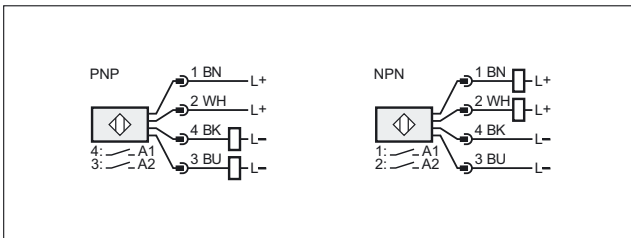

17

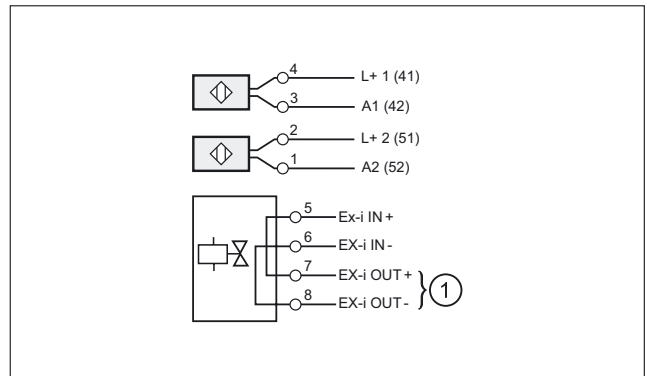

15

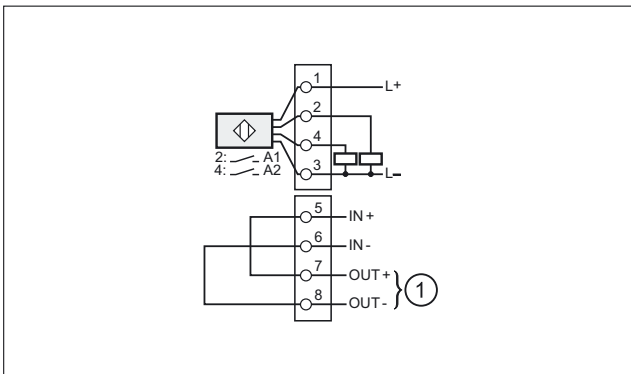

1: solenoid valve

18

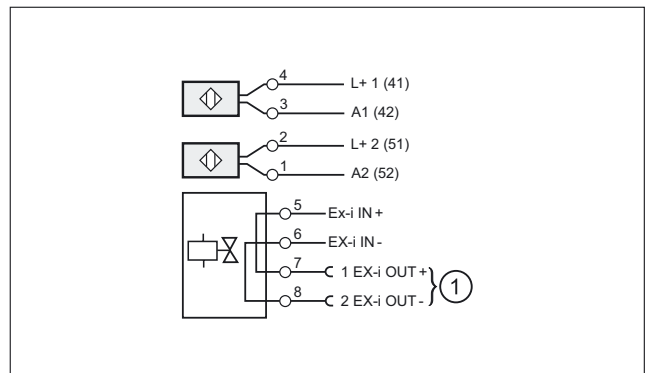



Process sensors

Scale drawings / drawing no. – CAD download: www.ifm.com

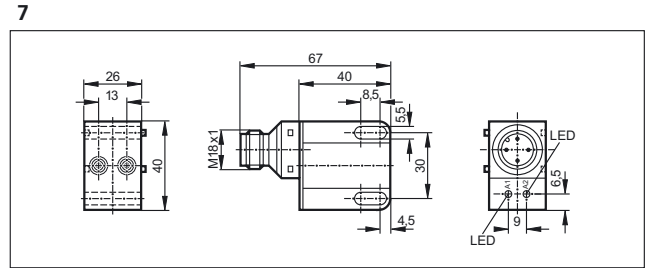
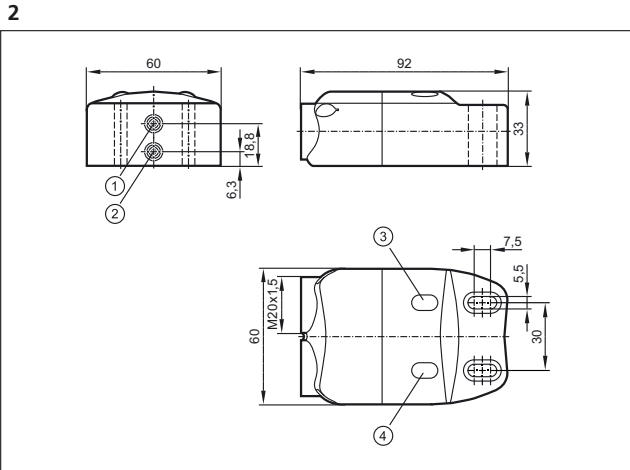
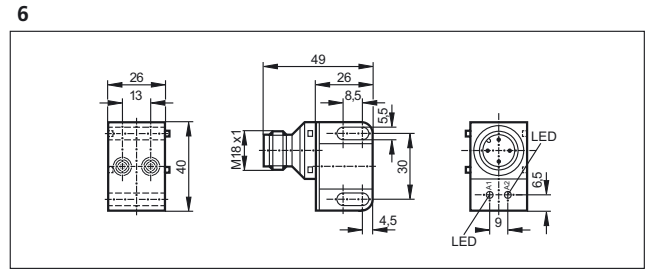
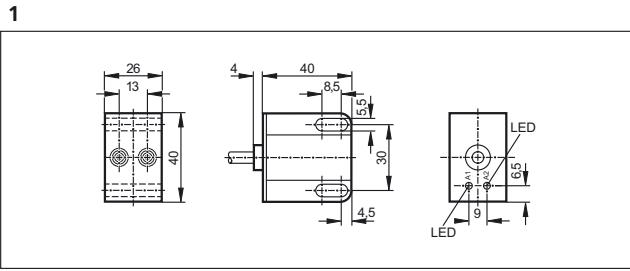

1: sensor 1, 2: sensor 2, 3: LED OUT 2, 4: LED OUT 1

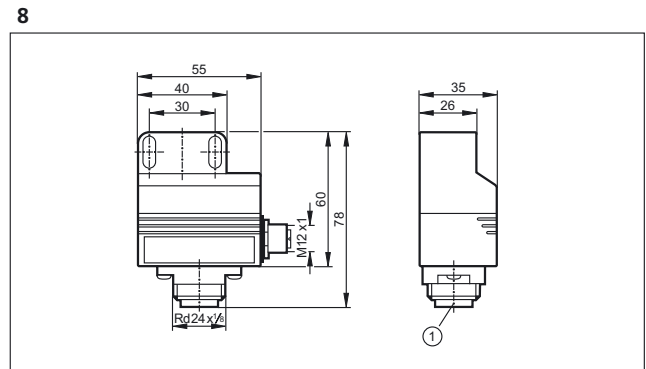

1: field connection

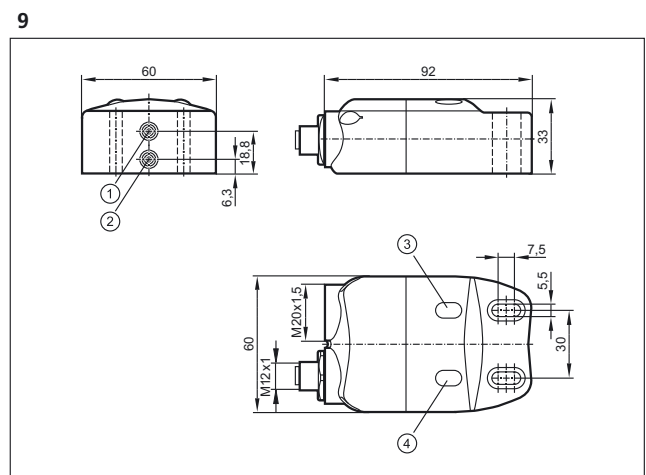
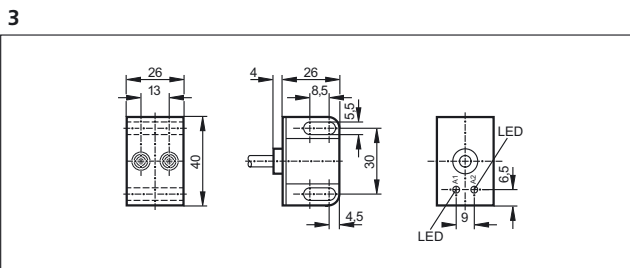

1: sensor 1, 2: sensor 2, 3: LED OUT 2, 4: LED OUT 1

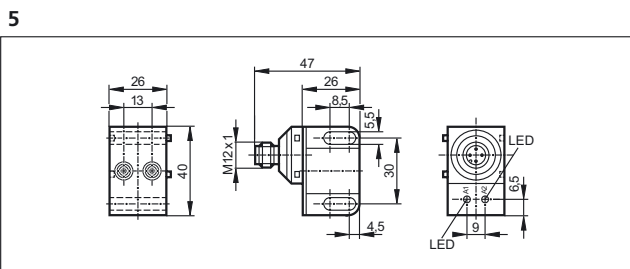
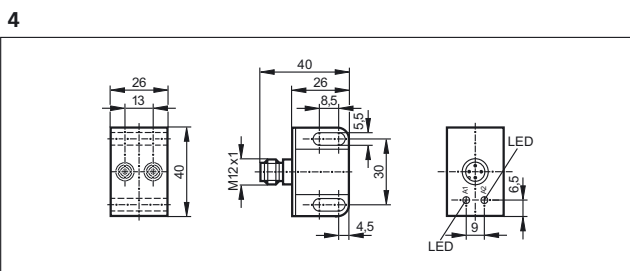

Scale drawings / drawing no. – CAD download: www.ifm.com

10

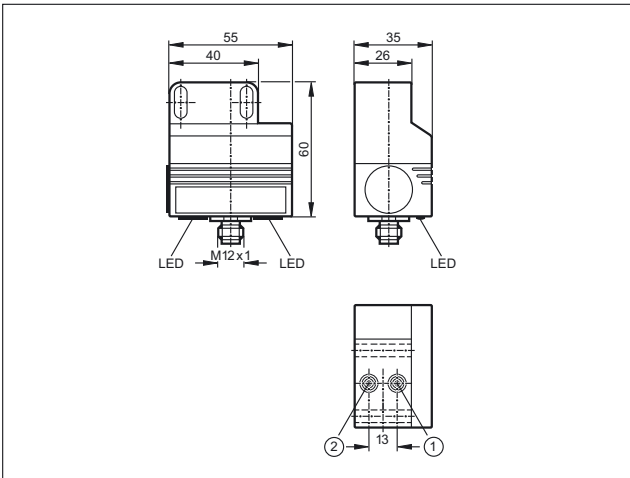

1: sensor 1, 2: sensor 2

11

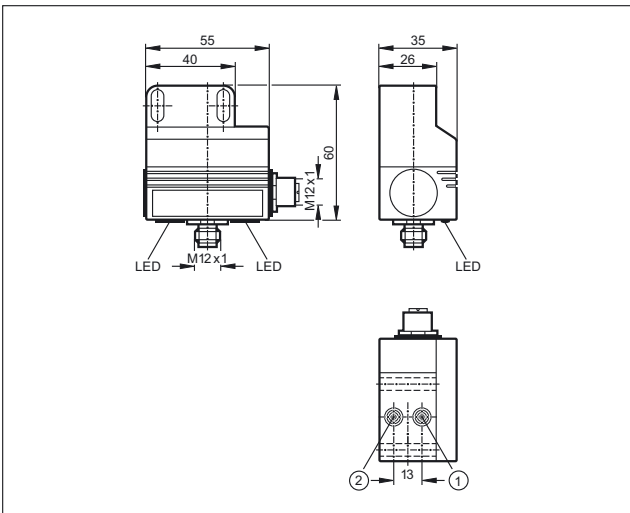

1: sensor 1, 2: sensor 2

12

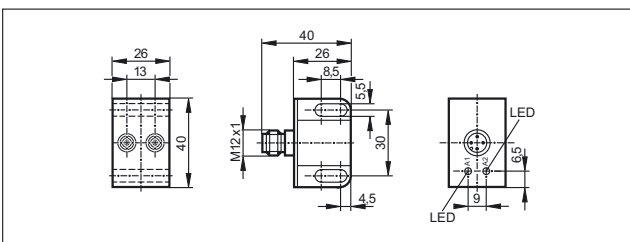

13

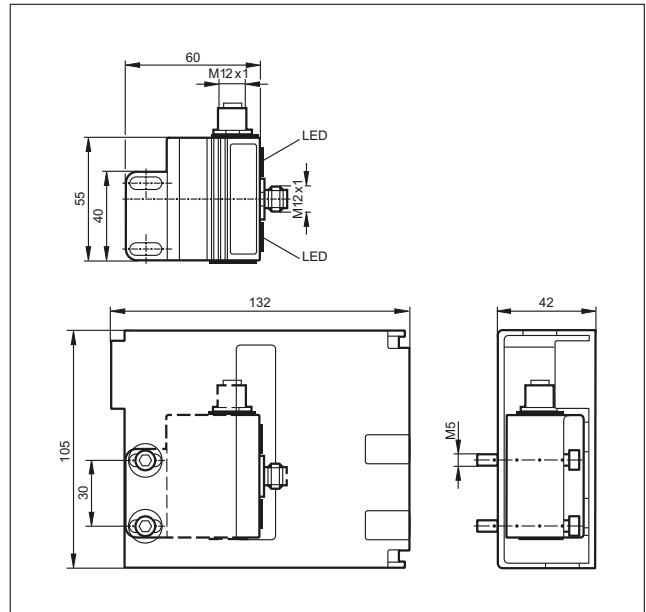

14

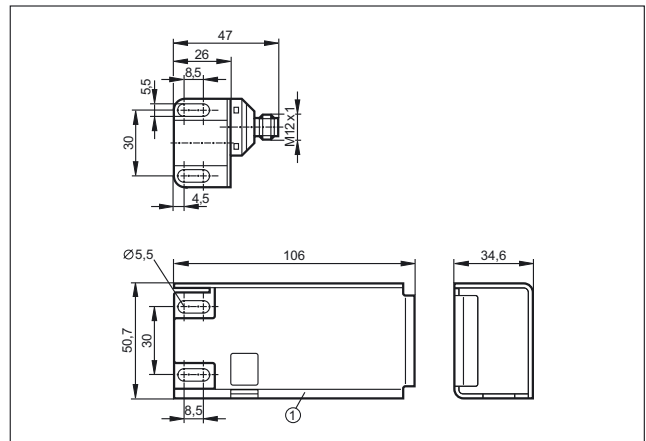

1: protective housing

15

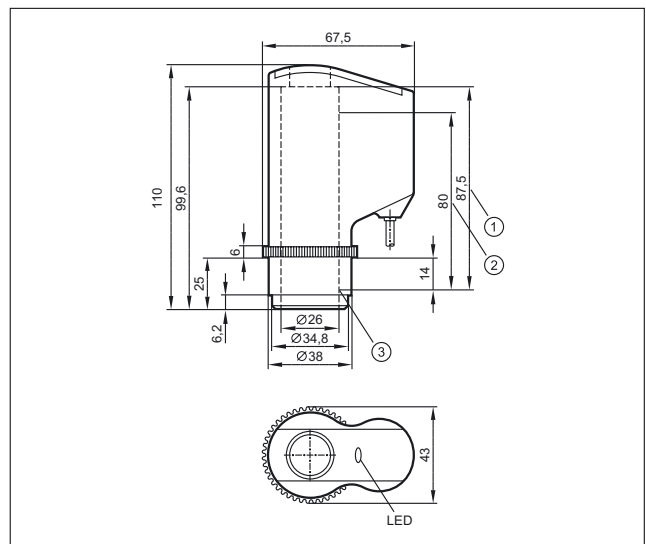

1: Max. spindle stroke, 2: Measuring range, 3: Initial value of the measuring range (zero point)



Process sensors

Scale drawings / drawing no. – CAD download: www.ifm.com

16

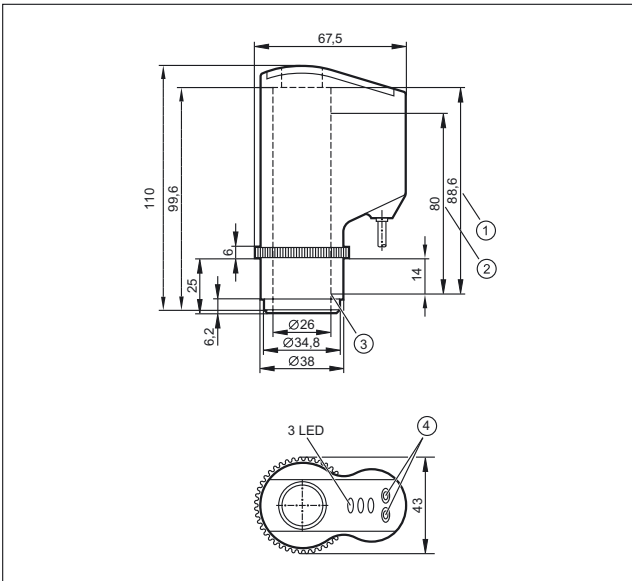

1: Max. spindle stroke, 2: Measuring distance, 3: Initial value of the measuring range (zero point), 4: Programming buttons

17

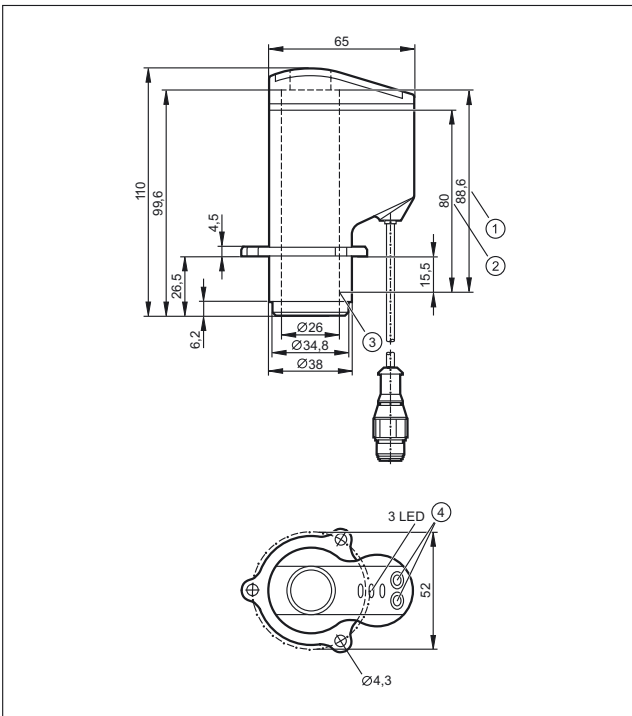

1: Max. spindle stroke, 2: Measuring distance, 3: Initial value of the measuring range (zero point), 4: Programming buttons

18

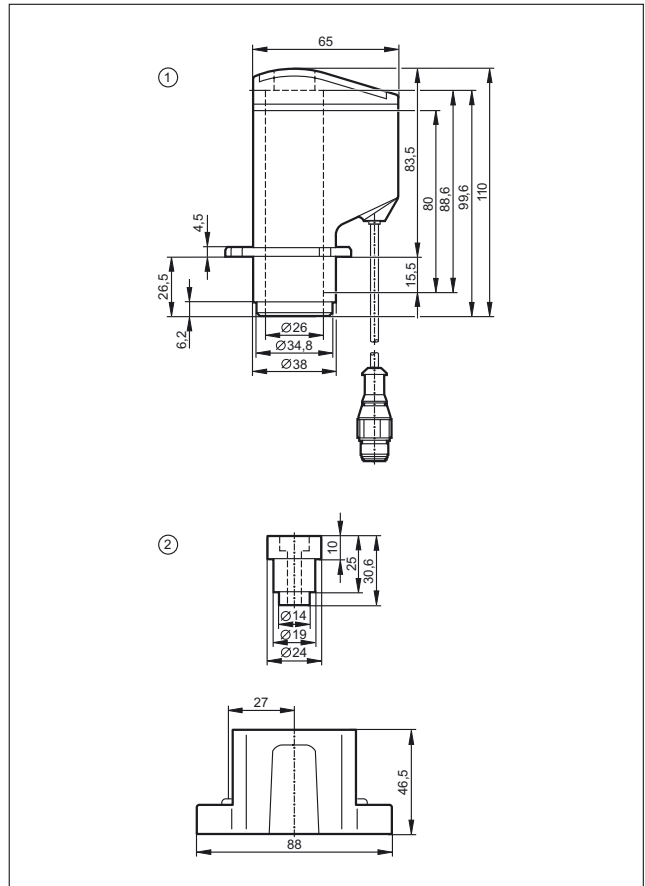

1: Valve sensor IX5010, 2: Mounting adapter E11900

19

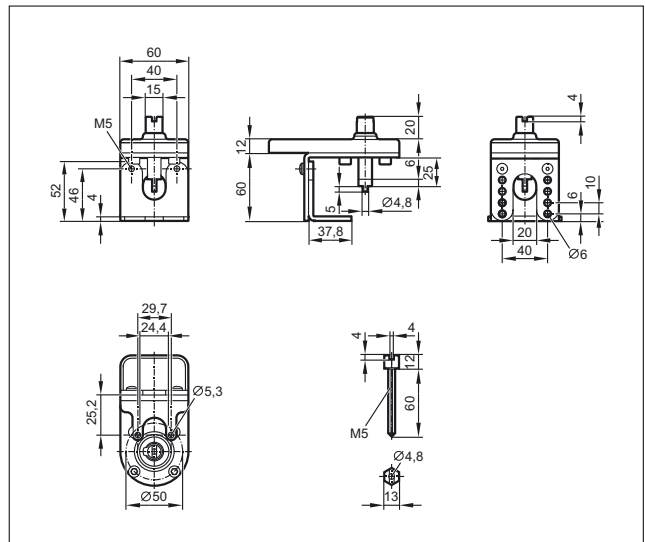

Scale drawings / drawing no. – CAD download: www.ifm.com

20

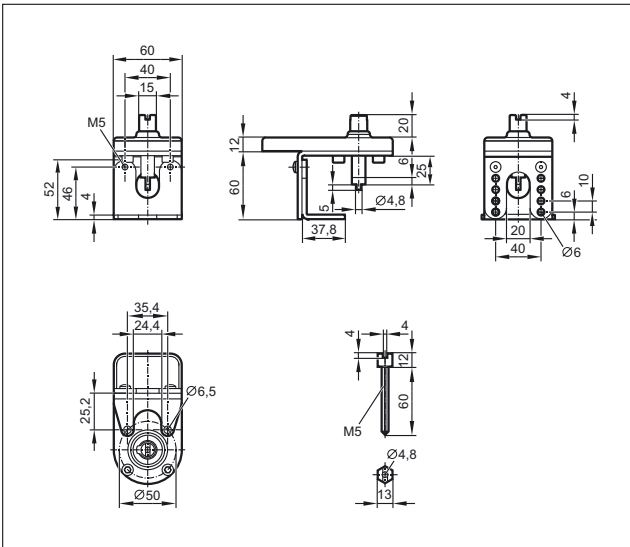

22

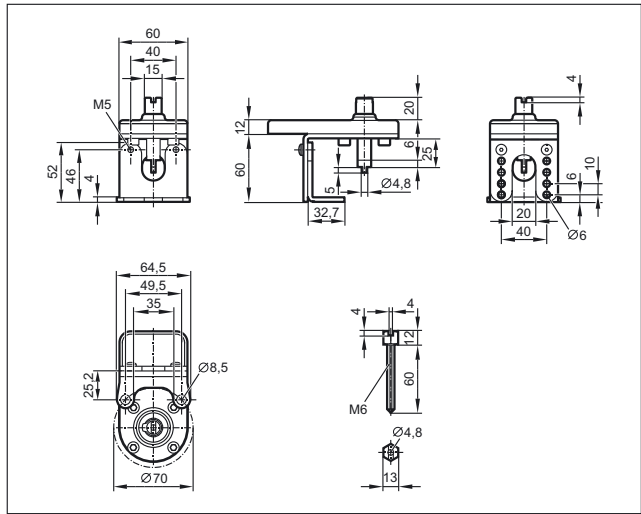

21

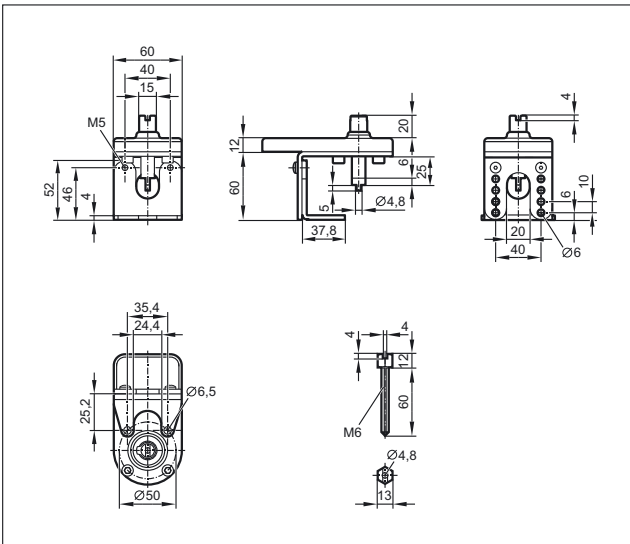

23

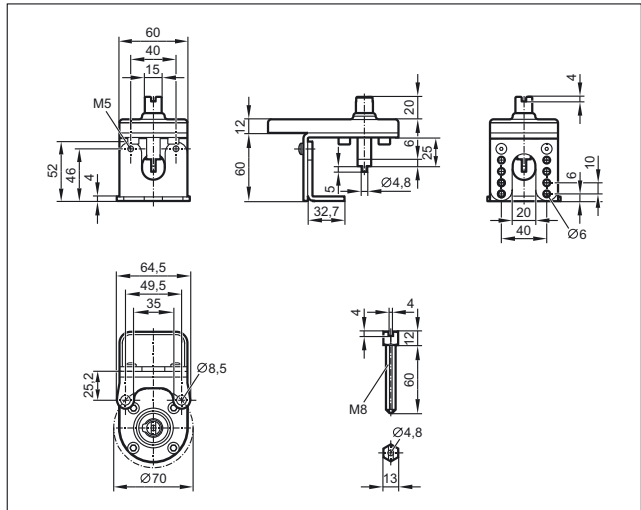

24

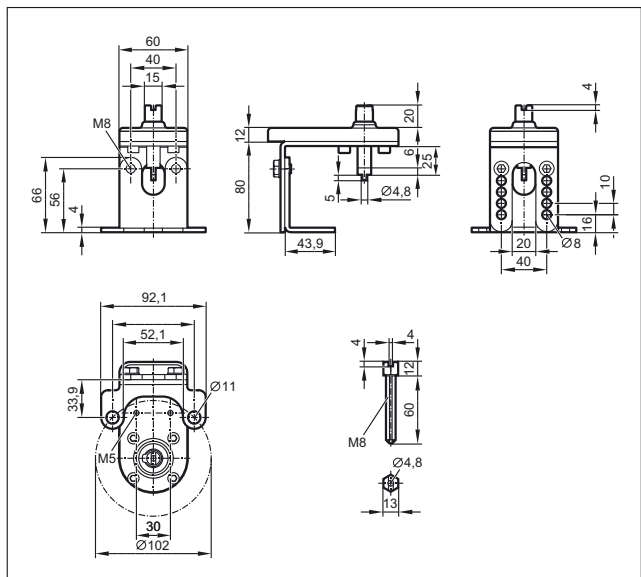



Fast and reliable communication with AS-i



Bus systems

AS-interface (AS-i = actuator sensor interface) is a manufacturer-independent standard for the connection of actuators and sensors of the first field level. It is the only wiring system accepted worldwide. With 20 million slaves installed, AS-i has been tried and tested as a low-cost feeder for all common fieldbuses for many years.

The product portfolio includes AS-i components for different areas: from packaging and conveying via silo applications, machine tools, robotics and automation to the food industry and mobile vehicles.

Safe

The sophisticated AS-i technology and the extended diagnostic possibilities provide high reliability and machine uptime. „Safety at Work“ is the AS-Interface expansion by safety-related components. Safety components up to SIL 3 to IEC 61508 and EN ISO 13849 - 1 / PL e can be connected to AS-i.

Simple

Due to the standardised system, the low wiring complexity and the quick connection technology, AS-i enables simple „Plug & Play“. The reduction of terminals leads to reduced documentation.

Data and energy are jointly transmitted via a two-wire cable. The reverse polarity protected insulation displacement technology helps avoid errors. The modularity and the tree structure smoothly fit to the way the plant is put together.

Cost-optimised

It's the end result that matters: Wiring complexity, documentation and set-up times are significantly reduced. The decentralisation of the AS-i participants leads to smaller and less expensive control cabinets. Simple diagnostics and a clear system design ensure high machine uptime and avoid downtimes.

	<i>AS-Interface controllers / gateways</i>	602 - 606
	<i>AS-Interface power supplies / earth fault monitors</i>	608 - 609
	<i>AS-Interface I/O modules</i>	610 - 629
	<i>AS-Interface AirBoxes for pneumatics</i>	630 - 633
	<i>AS-Interface sensors</i>	634 - 636
	<i>AS-Interface devices for valves and valve actuators</i>	638 - 640
	<i>AS-Interface expansion</i>	642 - 643
	<i>AS-Interface Safety at Work</i>	644 - 650
	<i>IO-Link components</i>	652 - 656



Industrial communication





AS-Interface controllers / gateways

AS-i controller and gateways have AS-i master functionality and are thus an elementary part of AS-i networks. These components are usually in a control cabinet and ensure data communication. A wide product range provides suitability for different applications. An integrated CoDeSys-programmable PLC allows that the AS-i controllers can also be used as supplementary or independent control system.

System overview	Page
Controllers, gateways and software	602 - 603
Controllers / Gateways	603 - 604
AS-i manuals	604
Scale drawings / drawing no. – CAD download: www.ifm.com	605 - 606

Controllers, gateways and software

Type	Number of AS-i masters	Description	Draw-ing no.	Order no.
	1	AS-i DP controller E · AS-i PLC with Profibus-DP interface · Full master functions · Graphic display · Housing materials: aluminium / steel sheet galvanised	1	AC1365
	2	AS-i DP controller E · AS-i PLC with Profibus-DP interface · Full master functions · Graphic display · Housing materials: aluminium / steel sheet galvanised	1	AC1366
	1	AS-i controller E · AS-i controller freely programmable · Profibus DP interface · Ethernet programming interface · Full master functions · Graphic display · Housing materials: aluminium / steel sheet galvanised	1	AC1355
	2	AS-i controller E · AS-i controller freely programmable · Profibus DP interface · Ethernet programming interface · Full master functions · Graphic display · Housing materials: aluminium / steel sheet galvanised	1	AC1356
	1	AS-i DeviceNet controller E · AS-i controller with DeviceNet interface · Full master functions · Graphic display · Housing materials: aluminium / steel sheet galvanised	2	AC1318
	2	AS-i DeviceNet controller E · AS-i controller with DeviceNet interface · Full master functions · Graphic display · Housing materials: aluminium / steel sheet galvanised	2	AC1324
	1	AS-i CANopen Controller E · AS-i controller with CANopen interface · Full master functions · Graphic display · Housing materials: aluminium / steel sheet galvanised	3	AC1331
	2	AS-i CANopen Controller E · AS-i controller with CANopen interface · Full master functions · Graphic display · Housing materials: aluminium / steel sheet galvanised	4	AC1332
	1	AS-i controller E · AS-i controller freely programmable · Full master functions · Graphic display · Ethernet programming interface · Housing materials: aluminium / steel sheet galvanised	5	AC1357

Type	Number of AS-i masters	Description	Draw- ing no.	Order no.
	2	AS-i controller E · AS-i controller freely programmable · Full master functions · Graphic display · Ethernet programming interface · Housing materials: aluminium / steel sheet galvanised	6	AC1358

Controllers / Gateways



Type	Number of AS-i masters	Description	Draw- ing no.	Order no.
	1	SmartLink DP · AS-i gateway / Profibus DP · Full master functions · Graphic display · Housing materials: aluminium / steel sheet galvanised	7	AC1375
	–	AS-i data decoupling module · Combicon connection · Housing materials: Makrolon	8	AC1250
	2	AS-i DP gateway · Full master functions · Graphic display · Profibus DP interface · Housing materials: aluminium / steel sheet galvanised	1	AC1376
	1	AS-i Profinet gateway · AS-i master · Ethernet configuration interface with dynamic web interface for configuration and diagnosis including remote maintenance · Profinet RT device class B · LCD colour display · Device supply either via 24 V or AS-i (AS-i bus 1) · Housing materials: aluminium powder-coated / steel sheet galvanised / Makrolon	9	AC1401
	2	AS-i Profinet gateway · AS-i master · Ethernet configuration interface with dynamic web interface for configuration and diagnosis including remote maintenance · Profinet RT device class B · LCD colour display · Device supply either via 24 V or AS-i (AS-i bus 1) · Housing materials: aluminium powder-coated / steel sheet galvanised / Makrolon	9	AC1402
	1	AS-i Profibus gateway · AS-i master · Ethernet configuration interface with dynamic web interface for configuration and diagnosis including remote maintenance · Profibus DP (DPV0 + DPV1) · LCD colour display · Device supply either via 24 V or AS-i (AS-i bus 1) · Housing materials: aluminium powder-coated / steel sheet galvanised / Makrolon	10	AC1411
	2	AS-i Profibus gateway · AS-i master · Ethernet configuration interface with dynamic web interface for configuration and diagnosis including remote maintenance · Profibus DP (DPV0 + DPV1) · LCD colour display · Device supply either via 24 V or AS-i (AS-i bus 1) · Housing materials: aluminium powder-coated / steel sheet galvanised / Makrolon	10	AC1412
	1	AS-i EtherNet/IP gateway · AS-i master · Ethernet configuration interface with dynamic web interface for configuration and diagnosis including remote maintenance · LCD colour display · Device supply either via 24 V or AS-i (AS-i bus 1) · Housing materials: aluminium powder-coated / steel sheet galvanised / Makrolon	9	AC1421
	2	AS-i EtherNet/IP gateway · AS-i master · Ethernet configuration interface with dynamic web interface for configuration and diagnosis including remote maintenance · LCD colour display · Device supply either via 24 V or AS-i (AS-i bus 1) · Housing materials: aluminium powder-coated / steel sheet galvanised / Makrolon	9	AC1422



Industrial communication

Type	Number of AS-i masters	Description	Drawing no.	Order no.
	1	SmartPLC DataLine with EtherNet/IP device interface · AS-i master · Ethernet configuration interface with dynamic web interface for configuration and diagnosis including remote maintenance · LCD colour display · Device supply either via 24 V or AS-i (AS-i bus 1) · Housing materials: aluminium powder-coated / steel sheet galvanised / Makrolon	11	AC1423
	1	SmartPLC DataLine with Profinet device interface · AS-i master · Ethernet configuration interface with dynamic web interface for configuration and diagnosis including remote maintenance · LCD colour display · Device supply either via 24 V or AS-i (AS-i bus 1) · Housing materials: aluminium powder-coated / steel sheet galvanised / Makrolon	11	AC1403
	1	SmartPLC DataLine with EtherCAT slave interface · AS-i master · Ethernet configuration interface with dynamic web interface for configuration and diagnosis including remote maintenance · LCD colour display · Device supply either via 24 V or AS-i (AS-i bus 1) · Housing materials: aluminium powder-coated / steel sheet galvanised / Makrolon	11	AC1433
	2	SmartPLC DataLine with Profinet device interface · AS-i master · Ethernet configuration interface with dynamic web interface for configuration and diagnosis including remote maintenance · LCD colour display · Device supply either via 24 V or AS-i (AS-i bus 1) · Housing materials: aluminium powder-coated / steel sheet galvanised / Makrolon	11	AC1404
	2	SmartPLC DataLine with EtherNet/IP device interface · AS-i master · Ethernet configuration interface with dynamic web interface for configuration and diagnosis including remote maintenance · LCD colour display · Device supply either via 24 V or AS-i (AS-i bus 1) · Housing materials: aluminium powder-coated / steel sheet galvanised / Makrolon	11	AC1424
	2	SmartPLC DataLine with EtherCAT slave interface · AS-i master · Ethernet configuration interface with dynamic web interface for configuration and diagnosis including remote maintenance · LCD colour display · Device supply either via 24 V or AS-i (AS-i bus 1) · Housing materials: aluminium powder-coated / steel sheet galvanised / Makrolon	11	AC1434

AS-i manuals

Type	Description	Order no.
	ecolog asi system · AS-Interface Manual (German)	AC0115
	ecolog asi system · AS-Interface Manual (English)	AC0116

Scale drawings / drawing no. – CAD download: www.ifm.com

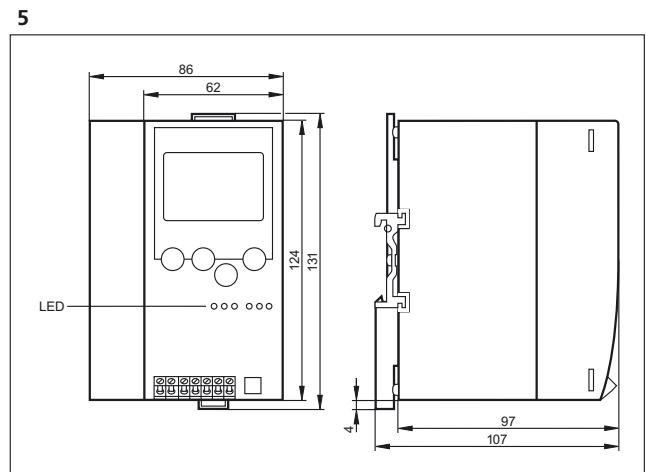
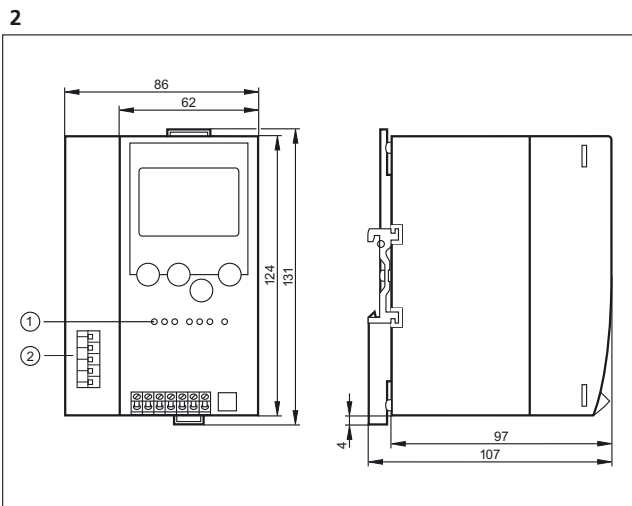
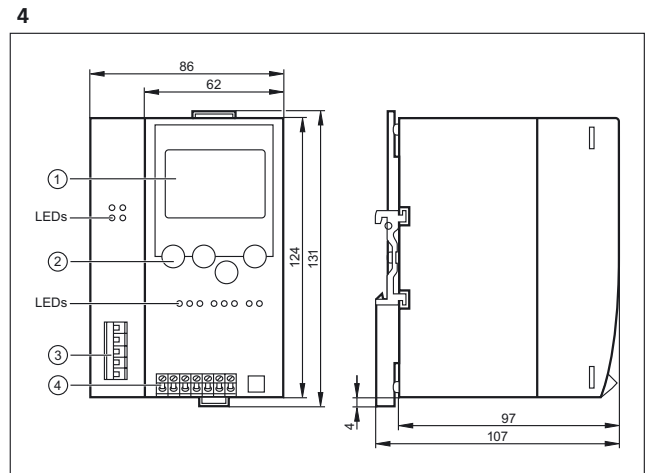
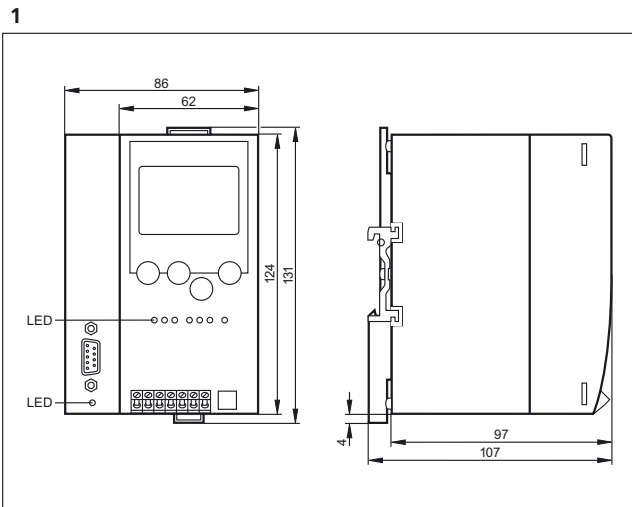

1: LED, 2: DeviceNet interface

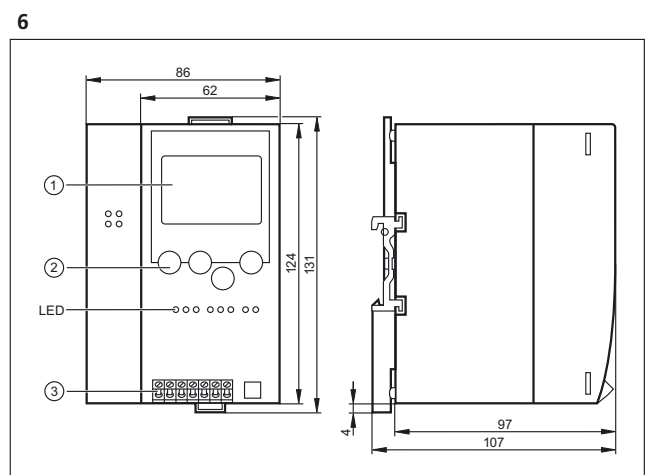
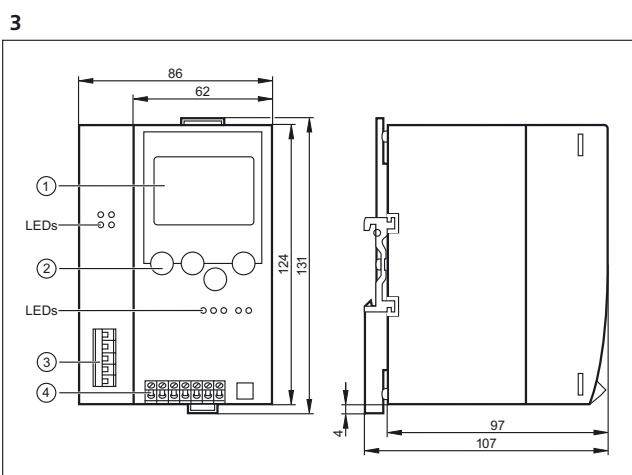

1: display, 2: control keys, 3: Ethernet interface



Scale drawings / drawing no. – CAD download: www.ifm.com

7

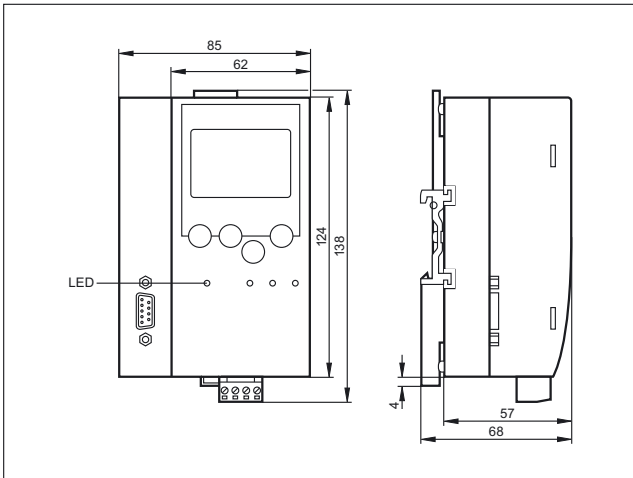

8

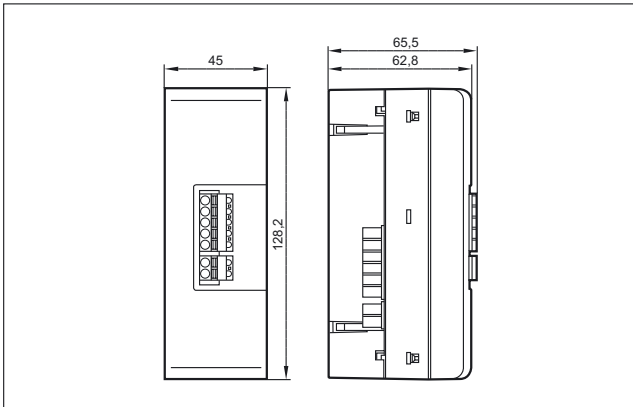

9

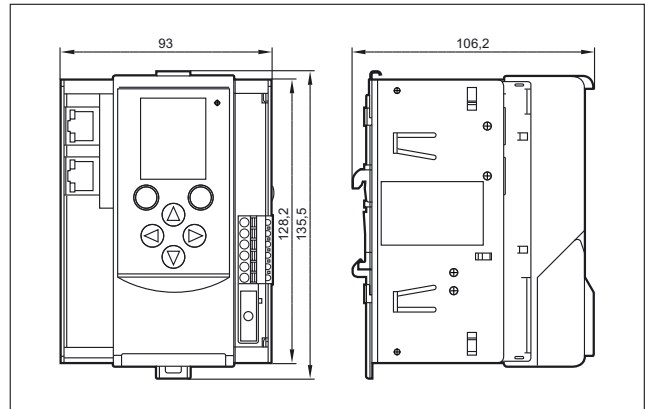

10

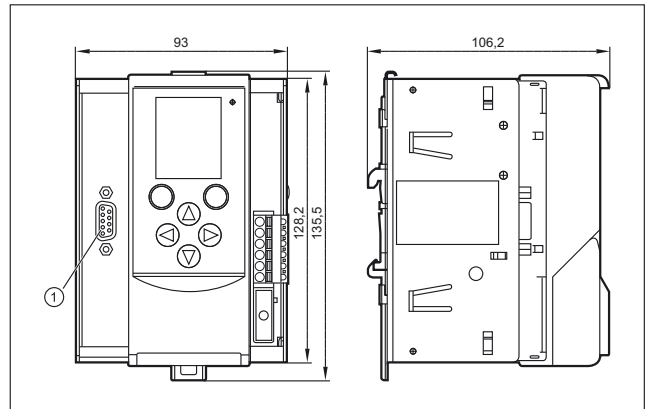

Sub-D (9-pole)

11

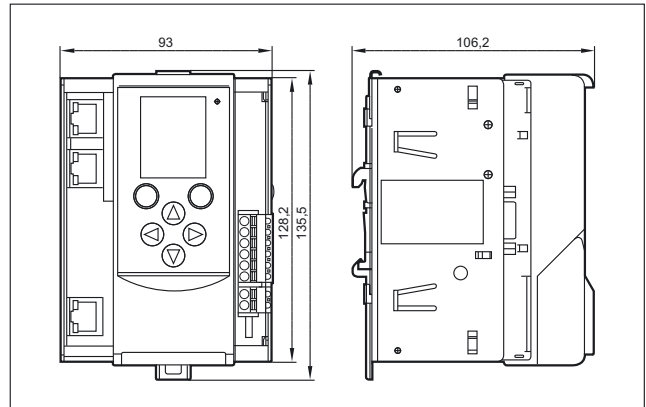





Industrial communication







AS-Interface power supplies / earth fault monitors

AS-i needs special AS-i power supplies for the communication and the voltage supply of the AS-i modules and the connected inputs and outputs (partly). They supply an unearthed voltage that is in particular suitable for communication insensitive to interference, in particular in industrial environments. By means of earth fault monitors the installation can be monitored for earthing problems.

System overview	Page
AS-i power supplies	608
Insulation monitors	608
Scale drawings / drawing no. – CAD download: www.ifm.com	609

AS-i power supplies

Type	Output current AS-i [A]	Description	Drawing no.	Order no.
	2.8	Power supply · AS-i power supply 115/230 V AC · Integrated data decoupling · NEC Class II Power Source · steel sheet	1	AC1256
	4	Power supply · DC convertor 24 V DC for AS-i system voltage · Integrated data decoupling · steel sheet	2	AC1257
	4	Power supply · AS-i power supply 115/230 V AC · Integrated data decoupling · steel sheet	1	AC1254
	8	Power supply · AS-i power supply 115/230 V AC · Integrated data decoupling · steel sheet	3	AC1258
	8	Power supply · Three-phase AS-i power supply 380...480 V AC · Integrated data decoupling · steel sheet	4	AC1253

Insulation monitors

Type	Description	Drawing no.	Order no.
	AS-i insulation monitor · Detection of asymmetric insulation faults · Screw terminal	5	AC2211
	AS-i insulation monitor · Detection of symmetric and asymmetric insulation faults · Screw terminal	5	AC2212

Scale drawings / drawing no. – CAD download: www.ifm.com

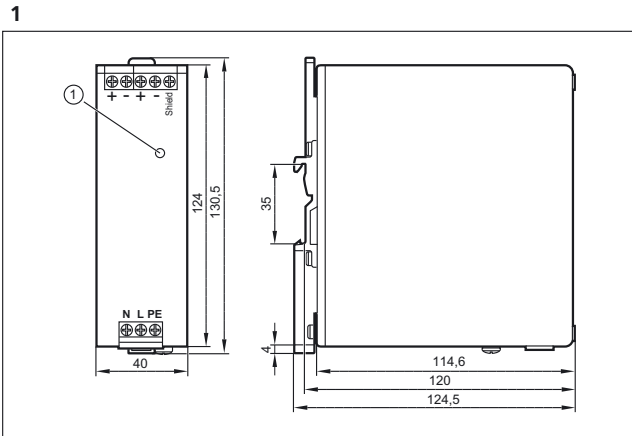

1: LED AS-i ok

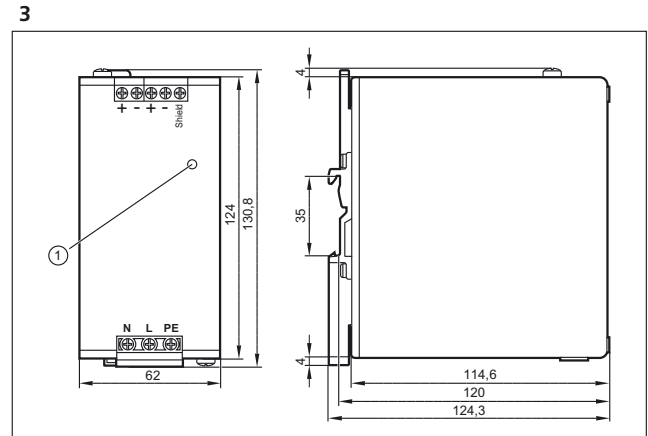

1: LED AS-i ok

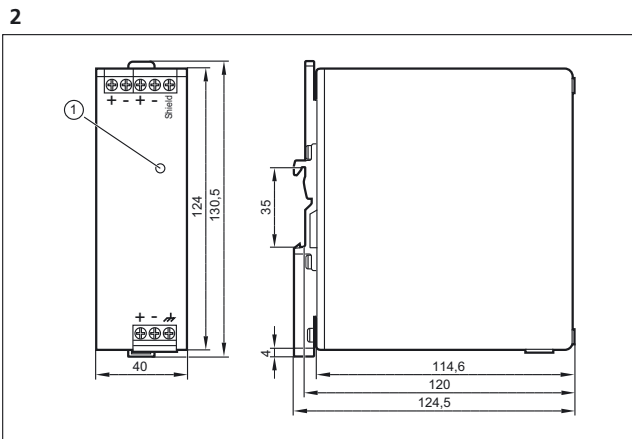

1: LED AS-i ok

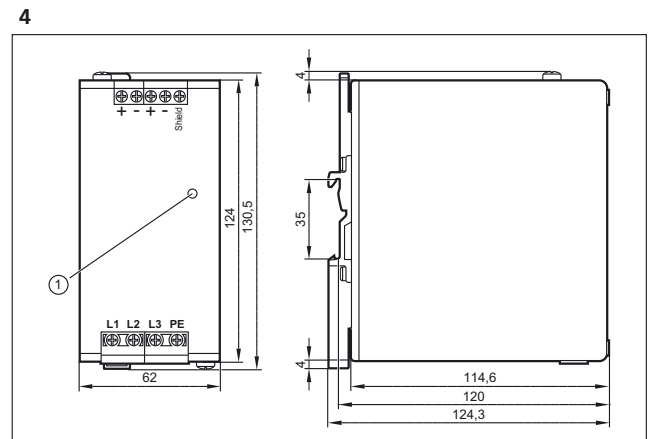

1: LED AS-i ok

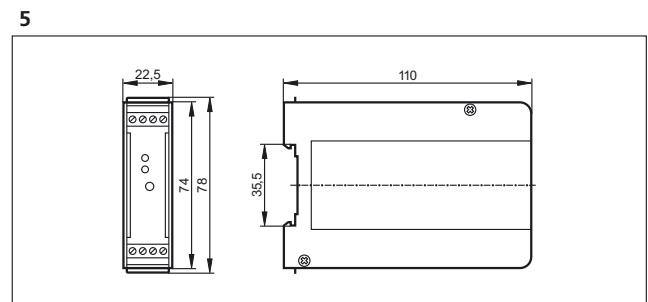



Industrial communication







AS-Interface I/O modules

The I/O modules are decentralised input and output modules of the AS-i interface for the connection of your digital and analogue inputs and outputs. Different applications have various requirements on the I/O modules regarding protection rating, resistance and materials used. The product range covers PCB solutions, control cabinet modules and I/O modules with protection rating IP69K.

System overview	Page
I/O modules for control cabinets	610 - 612
Field modules IP 67 AS-Interface	612 - 615
CompactLine modules	616 - 618
Universal modules AS-Interface	618
Field modules IP 69K and accessories	618 - 619
Module lower parts	619
Combicon connectors	620
Flat cable splitters and accessories	620 - 622
Accessories lower parts and addressing units	622 - 624
Scale drawings / drawing no. – CAD download: www.ifm.com	624 - 629







I/O modules for control cabinets

Type	Inputs / outputs	Description	Drawing no.	Order no.
	4 inputs	Active AS-i module · String mounting possible · Addressing socket · Version 2.1 with extended addressing mode · Digital inputs · Combicon connection · PA	1	AC2250
	4 inputs	Active AS-i module · String mounting possible · Addressing socket · Input supply from external PELV voltage source · Version 2.1 with extended addressing mode · Digital inputs · Combicon connection · PA	1	AC2254
	4 outputs	Active AS-i module · String mounting possible · Addressing socket · Version 2.1 · Digital outputs · Combicon connection · PA	1	AC2252
	4 inputs / 2 outputs / relay	Active AS-i module · String mounting possible · Addressing socket · Version 2.1 with extended addressing mode · Digital inputs · Combicon connection · PA	1	AC2256
	4 inputs / 2 outputs / relay	Active AS-i module · String mounting possible · Addressing socket · Input supply from external PELV voltage source · Version 2.1 with extended addressing mode · Digital inputs and outputs · Combicon connection · PA	1	AC2255



Type	Inputs / outputs	Description	Draw- ing no.	Order no.
	4 inputs / 3 outputs	Active AS-i module · String mounting possible · Addressing socket · Version 2.1 with extended addressing mode · Digital inputs and outputs · Combicon connection · PA	1	AC2264
	4 inputs / 4 outputs	Active AS-i module · String mounting possible · Addressing socket · Version 2.1 · Digital inputs and outputs · Combicon connection · PA	1	AC2251
	4 inputs / 4 outputs	Active AS-i module · String mounting possible · Addressing socket · External sensor supply PELV · Version 2.1 · Digital inputs and outputs · Combicon connection · PA	1	AC2257
	4 inputs / 4 outputs	Active AS-i module · String mounting possible · Addressing socket · External sensor supply PELV · Version 3.0 with extended addressing mode · Only for operation with AS-i masters with the profile M4 · Digital inputs and outputs · Combicon connection · PA	2	AC2267
	4 inputs / 4 outputs / relay	Active AS-i module · String mounting possible · Addressing socket · Version 2.1 · Combicon connection · PA 6.6	3	AC2258
	4 inputs / 4 outputs / relay	Active AS-i module · String mounting possible · Addressing socket · Input supply from external PELV voltage source · Version 2.1 · Combicon connection · PA 6.6	3	AC2259
	4 inputs / 4 outputs	Active AS-i module · PCB size 105 x 45 x 17 mm · Wire length 0.2 m · Digital inputs and outputs	4	AC2709
	4 inputs / 3 outputs	Active AS-i module · AS-i slave with extended addressing mode · PCB size 105 x 45 x 17 mm · Wire length 0.2 m · Digital inputs and outputs	4	AC2739
	2 inputs / 1 LED output	Active AS-i module · Only suited for mechanical contacts · Wire length 0.1 m	5	AC2729
	3 inputs / 3 outputs	Active AS-i module · AS-i version 2.1 with extended addressing mode	6	AC2731
	4 inputs / 4 outputs	Active AS-i module · AS-i slave with extended addressing mode · Only for operation with AS-i masters with the profile M4 · 12 x 0.2 m · housing: PC potted	7	AC2750
	4 inputs / 3 outputs	Active AS-i module · AS-i slave with extended addressing mode · 11 x 0.2 m · housing: PC potted	8	AC2751
	4 inputs / 4 outputs	Active AS-i module · AS-i slave with extended addressing mode · Only for operation with AS-i masters with the profile M4 · housing: PC potted	9	AC2752
	4 inputs / 3 outputs	Active AS-i module · AS-i slave with extended addressing mode · housing: PC potted	10	AC2753
	4 inputs / 4 outputs	Active AS-i module · String mounting possible · Version 3.0 with extended addressing mode · Only for operation with AS-i masters with the profile M4 · plastics / PC GF20	11	AC3200
	4 inputs / 4 outputs	Active AS-i module · String mounting possible · Version 3.0 with extended addressing mode · Only for operation with AS-i masters with the profile M4 · plastics / PC GF20	11	AC3201
	4 inputs	Active AS-i module · String mounting possible · Version 2.11 and 3.0 with extended addressing mode · plastics / PC GF20	12	AC3202





Industrial communication

Type	Inputs / outputs	Description	Drawing no.	Order no.
	4 outputs	Active AS-i module · String mounting possible · Versions 2.11 and 3.0 · plastics / PC GF20	13	AC3203
	4 inputs	Active AS-i module · String mounting possible · Version 2.11 and 3.0 with extended addressing mode · plastics / PC GF20	12	AC3204
	4 analogue inputs 4...20 mA	Active AS-i module · Supply either from AS-i or an external 24 V source · Combicon connector for sensor connection · PC GF20	14	AC3216
	4 analogue inputs 0...10 V	Active AS-i module · Supply either from AS-i or an external 24 V source · Combicon connector for sensor connection · PC GF20	14	AC3217
	4 analogue outputs 0...20 mA	Active AS-i module · Supply either from AS-i or an external 24 V source · Combicon connector for actuator connection · PC GF20	15	AC3218
	4 analogue outputs 0...10 V	Active AS-i module · Supply either from AS-i or an external 24 V source · Combicon connector for actuator connection · PC GF20	15	AC3219
	4 inputs / 4 outputs	Active AS-i module · String mounting possible · Addressing socket · Version 3.0 with extended addressing mode · Only for operation with AS-i masters with the profile M4 · plastics / PC GF20	16	AC3220
	4 inputs / 4 outputs	Active AS-i module · String mounting possible · Addressing socket · Version 3.0 with extended addressing mode · Only for operation with AS-i masters with the profile M4 · plastics / PC GF20	16	AC3221
	4 inputs Pt100	Active AS-i module · Combicon connection · PC GF20	17	AC3222













Field modules IP 67 AS-Interface

Type	Inputs / outputs	Description	Drawing no.	Order no.
	4-way splitter box	ClassicLine splitter box module · Three orientations of the flat cable are possible · AS-i and AUX splitter box for the connection of intelligent sensors/actuators · Sockets M12 x 1 · PA / Piercing contacts: CuSn6 surface nickel and tin-plated	18	AC5200
	4 inputs	Active ClassicLine module · Addressing socket · Three orientations of the flat cable are possible · Digital inputs · Sockets M12 x 1 · PA / Piercing contacts: CuSn6 surface nickel and tin-plated	18	AC5205
	4 inputs	Active ClassicLine module · Version 2.11 and 3.0 with extended addressing mode · Addressing socket · Three orientations of the flat cable are possible · Digital inputs · Sockets M12 x 1 · PA / Piercing contacts: CuSn6 surface nickel and tin-plated	18	AC5215
	4 analogue inputs 4...20 mA	Active ClassicLine module · 4 analogue inputs 4...20 mA · For the connection of 2-wire and 3-wire sensors · Three orientations of the flat cable are possible · PA / Piercing contacts: CuSn6 surface nickel and tin-plated	18	AC5216

Type	Inputs / outputs	Description	Draw- ing no.	Order no.
	3 outputs	Active ClassicLine module · Version 2.11 and 3.0 with extended addressing mode · Addressing socket · Three orientations of the flat cable are possible · Digital outputs · Sockets M12 x 1 · PA / Piercing contacts: CuSn6 surface nickel and tin-plated	18	AC5203
	4 outputs	Active ClassicLine module · Addressing socket · Three orientations of the flat cable are possible · Digital outputs · Sockets M12 x 1 · PA / Piercing contacts: CuSn6 surface nickel and tin-plated	18	AC5208
	4 outputs	Active ClassicLine module · Addressing socket · Three orientations of the flat cable are possible · Digital outputs 2 A · Sockets M12 x 1 · PA / Piercing contacts: CuSn6 surface nickel and tin-plated	18	AC5213
	2 outputs / 2 inputs	Active ClassicLine module · Version 2.11 and 3.0 with extended addressing mode · Addressing socket · Three orientations of the flat cable are possible · Digital outputs and inputs · Sockets M12 x 1 · PA / Piercing contacts: CuSn6 surface nickel and tin-plated	18	AC5214
	2 inputs / 2 outputs	Active ClassicLine module · Addressing socket · Three orientations of the flat cable are possible · Digital inputs and outputs (2 A) · Sockets M12 x 1 · PA / Piercing contacts: CuSn6 surface nickel and tin-plated	18	AC5211
	2 outputs / 2 inputs	Active ClassicLine module · Version 2.11 and 3.0 with extended addressing mode · Addressing socket · Three orientations of the flat cable are possible · Outputs supplied from AS-i · Digital outputs and inputs · Sockets M12 x 1 · PA / Piercing contacts: CuSn6 surface nickel and tin-plated	18	AC5224
	4 inputs / 3 outputs	Active ClassicLine module · Version 2.11 and 3.0 with extended addressing mode · Addressing socket · Three orientations of the flat cable are possible · inputs externally supplied · Sockets M12 x 1 · PA / Piercing contacts: CuSn6 surface nickel and tin-plated	19	AC5292
	8 digital inputs (2 slaves)	Active ClassicLine module · Version 2.11 and 3.0 with extended addressing mode · Addressing socket · Three orientations of the flat cable are possible · Digital inputs · Sockets M12 x 1 · PA / Piercing contacts: CuSn6 surface nickel and tin-plated	19	AC5210
	4 inputs / 4 outputs	Active ClassicLine module · Addressing socket · Three orientations of the flat cable are possible · Digital inputs and outputs · Sockets M12 x 1 · PA / Piercing contacts: CuSn6 surface nickel and tin-plated	19	AC5209
	4 inputs / 4 outputs	Active ClassicLine module · Addressing socket · Three orientations of the flat cable are possible · Digital inputs and outputs (2 A) · Sockets M12 x 1 · PA / Piercing contacts: CuSn6 surface nickel and tin-plated	19	AC5212
	4 inputs / 3 outputs	Active ClassicLine module · Addressing socket · Three orientations of the flat cable are possible · Version 2.11 and 3.0 with extended addressing mode · Digital inputs and outputs · Sockets M12 x 1 · PA / Piercing contacts: CuSn6 surface nickel and tin-plated	19	AC5204
	4 inputs / 4 outputs	Active ClassicLine module · Only for operation with AS-i masters with the profile M4 · Addressing socket · Three orientations of the flat cable are possible · Version 3.0 with extended addressing mode · Digital inputs and outputs · Sockets M12 x 1 · PA / Piercing contacts: CuSn6 surface nickel and tin-plated	19	AC5235



Industrial communication

Type	Inputs / outputs	Description	Drawing no.	Order no.
	4 inputs / 4 outputs	Active ClassicLine module · Addressing socket · Three orientations of the flat cable are possible · Version 3.0 with extended addressing mode · Only for operation with AS-i masters with the profile M4 · Digital inputs and outputs (2 A) · Sockets M12 x 1 · PA / Piercing contacts: CuSn6 surface nickel and tin-plated	19	AC5236
	4 inputs	Active ClassicLine module · Version 2.11 and 3.0 with extended addressing mode · Addressing socket · Three orientations of the flat cable are possible · Digital inputs · Sockets M12 x 1 · PA / Piercing contacts: CuSn6 surface nickel and tin-plated	18	AC5245
	4 inputs / 4 outputs	Active ClassicLine module · Only for operation with AS-i masters with the profile M4 · Addressing socket · Three orientations of the flat cable are possible · Version 3.0 with extended addressing mode · Digital inputs and outputs · Sockets M12 x 1 · PA / Piercing contacts: CuSn6 surface nickel and tin-plated	19	AC5275
	4 inputs / 4 outputs	Active ClassicLine module · Version 3.0 with extended addressing mode · Addressing socket · Only for operation with AS-i masters with the profile M4 · Three orientations of the flat cable are possible · inputs externally supplied · Digital inputs and outputs · Sockets M12 x 1 · PA / Piercing contacts: CuSn6 surface nickel and tin-plated	19	AC5293
	2 outputs / 2 inputs	Active ClassicLine module · Version 2.11 and 3.0 with extended addressing mode · Addressing socket · Digital inputs and outputs (2 A) · Three orientations of the flat cable are possible · Sockets M12 x 1 · PA / Piercing contacts: CuSn6 surface nickel and tin-plated	18	AC5234
	2 analogue outputs 4...20 mA	Active ClassicLine module · Electrical isolation · Three orientations of the flat cable are possible · Sockets M12 x 1 · PA / Piercing contacts: CuSn6 surface nickel and tin-plated	18	AC5218
	2 pushbuttons / 2 LED displays	Active module upper parts AS-i illuminated pushbutton module · Power supply via AS-i cable · A/B slave · Pushbutton functions: normally open / normally closed · PBT	20	AC2088
	2 pushbuttons / 2 LED displays	Active module upper parts AS-i illuminated pushbutton module · Power supply via AS-i cable · Colour inserts changeable · PBT	21	AC2086
	4 inputs 4...20 mA	Active ClassicLine module · AS-i profile S-7.3 · 4 analogue inputs 4...20 mA · IR addressing possible · For the connection of 2-wire, 3-wire or 4-wire sensors · Sockets M12 x 1 · PBT	22	AC2516
	4 inputs 0...10 V	Active ClassicLine module · AS-i profile S-7.3 · 4 analogue inputs 0...10 V · IR addressing possible · For the connection of 2-wire, 3-wire or 4-wire sensors · Sockets M12 x 1 · PBT	22	AC2517
	2 inputs 4...20 mA	Active ClassicLine module · 2 analogue inputs 4...20 mA · For the connection of 2-wire and 3-wire sensors · Addressing socket · Three orientations of the flat cable are possible · PA / Piercing contacts: CuSn6 surface nickel and tin-plated	18	AC5222
	2 inputs 4...20 mA	Active ClassicLine module · 2 analogue inputs 4...20 mA · For the connection of 2-wire and 4-wire sensors · Electrical isolation · Addressing socket · Three orientations of the flat cable are possible · PA / Piercing contacts: CuSn6 surface nickel and tin-plated	18	AC5223

Product selectors and further information can be found at: www.ifm.com

Type	Inputs / outputs	Description	Draw- ing no.	Order no.
	2 IO-Link ports	Active ClassicLine module · 2 IO-Link ports · For the connection of IO-Link sensors and actuators, binary sensors and binary actuators · Addressing socket · Three orientations of the flat cable are possible · Only for operation with AS-i masters with the profile M4 · PA / Piercing contacts: CuSn6 surface nickel and tin-plated	18	AC5225
	4 analogue inputs 4...20 mA	Active ClassicLine module · 4 analogue inputs 4...20 mA · For the connection of 2-wire, 3-wire or 4-wire sensors · Electrical isolation · Three orientations of the flat cable are possible · PA / Piercing contacts: CuSn6 surface nickel and tin-plated	18	AC5226
	2 digital inputs / 1 analogue input / 1 analogue output	Active ClassicLine module · Only for operation with AS-i masters with the profile M4 · Electrical isolation · Three orientations of the flat cable are possible · Sockets M12 x 1 · PA / Piercing contacts: CuSn6 surface nickel and tin-plated	18	AC5230
	4 inputs	Active ClassicLine module · Addressing socket · Three orientations of the flat cable are possible · ATEX approval · Group II, category 3D · Only in conjunction with impact protection housing E7000A or equivalent protection · Sockets M12 x 1 · PA / Piercing contacts: CuSn6 surface nickel and tin-plated	18	AC505A
	4 inputs	Active ClassicLine module · Version 2.11 and 3.0 with extended addressing mode · Addressing socket · Three orientations of the flat cable are possible · ATEX approval · Group II, category 3D · Only in conjunction with impact protection housing E7000A or equivalent protection · Sockets M12 x 1 · PA / Piercing contacts: CuSn6 surface nickel and tin-plated	18	AC515A
	4 outputs	Active ClassicLine module · Addressing socket · Three orientations of the flat cable are possible · ATEX approval · Group II, category 3D · Only in conjunction with impact protection housing E7000A or equivalent protection · Sockets M12 x 1 · PA / Piercing contacts: CuSn6 surface nickel and tin-plated	18	AC508A
	2 inputs / 2 outputs	Active ClassicLine module · Addressing socket · Three orientations of the flat cable are possible · ATEX approval · Group II, category 3D · Only in conjunction with impact protection housing E7000A or equivalent protection · Digital inputs and outputs (2 A) · Sockets M12 x 1 · PA / Piercing contacts: CuSn6 surface nickel and tin-plated	18	AC507A
	2 outputs / 2 inputs	Active ClassicLine module · Version 2.11 and 3.0 with extended addressing mode · Addressing socket · Three orientations of the flat cable are possible · ATEX approval · Group II, category 3D · Only in conjunction with impact protection housing E7000A or equivalent protection · Sockets M12 x 1 · PA / Piercing contacts: CuSn6 surface nickel and tin-plated	18	AC514A
	2 inputs 4...20 mA	Active ClassicLine module · 2 analogue inputs 4...20 mA · For the connection of 2-wire and 3-wire sensors · Addressing socket · Three orientations of the flat cable are possible · ATEX approval · Group II, category 3D · Only in conjunction with impact protection housing E7000A or equivalent protection · PA / Piercing contacts: CuSn6 surface nickel and tin-plated	18	AC522A
	4 inputs / 4 outputs	Active ClassicLine module · Only for operation with AS-i masters with the profile M4 · Addressing socket · Three orientations of the flat cable are possible · Version 3.0 with extended addressing mode · ATEX approval · Group II, category 3D · Only in conjunction with impact protection housing E7000A or equivalent protection · Sockets M12 x 1 · PA / Piercing contacts: CuSn6 surface nickel and tin-plated	19	AC535A



CompactLine modules

Type	Inputs / outputs	Description	Draw- ing no.	Order no.
	2 inputs 4...20 mA	Active CompactLine module · 2 analogue inputs 4...20 mA · For the connection of 2-wire and 3-wire sensors · IR addressing possible · high-grade stainless steel · Sockets M12 x 1 · PA / socket: stainless steel 316L / 1.4404 / threaded inserts in the lower part: stainless steel 316L / 1.4404 / screws in the lower part: stainless steel / Piercing contacts: CuSn6 surface nickel and tin-plated	23	AC2402
	2 inputs 4...20 mA	Active CompactLine module · 2 analogue inputs 4...20 mA · For the connection of 2-wire and 4-wire sensors · Electrical isolation · IR addressing possible · high-grade stainless steel · Sockets M12 x 1 · PA / socket: stainless steel 316L / 1.4404 / threaded inserts in the lower part: stainless steel 316L / 1.4404 / screws in the lower part: stainless steel / Piercing contacts: CuSn6 surface nickel and tin-plated	23	AC2403
	4-way splitter box	Passive compact module · AS-i splitter box for the connection of intelligent sensors/actuators · Sockets M12 x 1 · PA 6.6 / socket: Brass nickel-plated / threaded inserts in the lower part: Brass nickel-plated / O-Ring : Viton / Piercing contacts: CuSn6 surface nickel and tin-plated	24	AC2413
	4 inputs	Active CompactLine module · fully potted housing · IR addressing possible · Digital inputs · Sockets M12 x 1 · PA / socket: Brass nickel-plated / threaded inserts in the lower part: Brass nickel-plated / O-Ring : Viton / Piercing contacts: CuSn6 surface nickel and tin-plated	25	AC2410
	4 inputs	Active CompactLine module · IR addressing possible · Version 2.11 and 3.0 with extended addressing mode · Digital inputs · Sockets M12 x 1 · PA / socket: Brass nickel-plated / threaded inserts in the lower part: Brass nickel-plated / O-Ring : Viton / Piercing contacts: CuSn6 surface nickel and tin-plated	25	AC2457
	4 inputs	Active CompactLine module · IR addressing possible · Metal parts from stainless steel · Digital inputs · Sockets M12 x 1 · PA / socket: stainless steel 316L / 1.4404 / threaded inserts in the lower part: stainless steel 316L / 1.4404 / screws: stainless steel / Piercing contacts: CuSn6 surface nickel and tin-plated / O-Ring : EPDM	25	AC2451
	4 outputs	Active CompactLine module · IR addressing possible · Digital outputs · Sockets M12 x 1 · PA / socket: Brass nickel-plated / threaded inserts in the lower part: Brass nickel-plated / O-Ring : Viton / Piercing contacts: CuSn6 surface nickel and tin-plated	26	AC2417
	2 inputs / 2 outputs	Active CompactLine module · 60 x 118.2 x 27 · IR addressing possible · Digital inputs and outputs · Sockets M12 x 1 · PA / socket: Brass nickel-plated / threaded inserts in the lower part: Brass nickel-plated / O-Ring : Viton / Piercing contacts: CuSn6 surface nickel and tin-plated	26	AC2411
	2 inputs / 2 outputs	Active CompactLine module · IR addressing possible · Digital inputs and outputs · Sockets M12 x 1 · PA / socket: Brass nickel-plated / threaded inserts in the lower part: Brass nickel-plated / O-Ring : Viton / Piercing contacts: CuSn6 surface nickel and tin-plated	26	AC2458
	4 inputs / 4 outputs	Active CompactLine module · 60 x 152 x 27 · IR addressing possible · Digital inputs and outputs · Sockets M12 x 1 · PA / socket: Brass nickel-plated / threaded inserts in the lower part: Brass nickel-plated / O-Ring : Viton / Piercing contacts: CuSn6 surface nickel and tin-plated	27	AC2412
	4 inputs / 4 outputs	Active CompactLine module · IR addressing possible · Digital inputs and outputs · Sockets M12 x 1 · PA / socket: Brass nickel-plated / threaded inserts in the lower part: Brass nickel-plated / O-Ring : Viton / Piercing contacts: CuSn6 surface nickel and tin-plated	27	AC2459





Type	Inputs / outputs	Description	Draw- ing no.	Order no.
	4 inputs / 4 outputs	Active CompactLine module · IR addressing possible · External sensor supply PELV · Digital inputs and outputs · Sockets M12 x 1 · PA / socket: Brass nickel-plated / threaded inserts in the lower part: Brass nickel-plated / O-Ring : Viton / Piercing contacts: CuSn6 surface nickel and tin-plated	27	AC2466
	4 inputs / 4 outputs	Active CompactLine module · IR addressing possible · Metal parts from stainless steel · Digital inputs and outputs · Sockets M12 x 1 · PA / socket: stainless steel 316L / 1.4404 / threaded inserts in the lower part: stainless steel 316L / 1.4404 / screws: stainless steel / Piercing contacts: CuSn6 surface nickel and tin-plated / O-Ring : EPDM	27	AC2452
	4 inputs / 4 outputs	Active CompactLine module · IR addressing possible · Version 3.0 with extended addressing mode · Only for operation with AS-i masters with the profile M4 · Digital inputs and outputs · Sockets M12 x 1 · PA / socket: Brass nickel-plated / threaded inserts in the lower part: Brass nickel-plated / O-Ring : Viton / Piercing contacts: CuSn6 surface nickel and tin-plated	27	AC2471
	4 inputs	Active CompactLine module · AS-i connection via M12 connector · Digital inputs · Sockets M12 x 1 · PA / socket: Brass nickel-plated / O-Ring : Viton	28	AC2464
	4 inputs / 4 outputs	Active CompactLine module · AS-i and AUX connection via M12 connector · Digital inputs and outputs · Sockets M12 x 1 · PA / socket: Brass nickel-plated / O-Ring : Viton	29	AC2465
	2 outputs / 2 inputs	Compact M8 AS-i module · 90.5 x 30 x 23.5 · Digital inputs and outputs supplied via AS-i · AS-i connection via M12 connector · Version 2.11 and 3.0 with extended addressing mode · M8 ecolink interface · Sockets M8 x 1 · PBT	30	AC2482
	4 inputs	Compact M8 AS-i module · 90.5 x 30 x 23.5 · Digital inputs · AS-i connection via M12 connector · Version 2.11 and 3.0 with extended addressing mode · M8 ecolink interface · Sockets M8 x 1 · PBT	30	AC2484
	8 inputs	Compact M8 AS-i module · 134.5 x 30 x 23.5 · Digital inputs · AS-i connection via M12 connector · Version 3.0 with extended addressing mode · M8 ecolink interface · Only for operation with AS-i masters with the profile M4 · Sockets M8 x 1 · PBT	31	AC2488
	4-way splitter box	Passive compact module · Metal parts from stainless steel · Sockets M12 x 1 · PA 6.6 / socket: stainless steel 316L / 1.4404 / threaded inserts in the lower part: stainless steel 316L / 1.4404 / O-Ring : EPDM / Piercing contacts: CuSn6 surface nickel and tin-plated / screws: stainless steel	24	AC2453
	4 inputs / 4 outputs; bidirectional	Active CompactLine module · IR addressing possible · Version 3.0 with extended addressing mode · Only for operation with AS-i masters with the profile M4 · Metal parts from stainless steel · Sockets M12 x 1 · PA 6.6 / socket: stainless steel 316L / 1.4404 / threaded inserts in the lower part: stainless steel 316L / 1.4404 / O-Ring : EPDM / Piercing contacts: CuSn6 surface nickel and tin-plated / screws: stainless steel	27	AC2454
	4 inputs / 4 outputs; bidirectional	Active CompactLine module · IR addressing possible · Version 3.0 with extended addressing mode · Only for operation with AS-i masters with the profile M4 · Metal parts from stainless steel · Sockets M12 x 1 · PA 6.6 / socket: stainless steel 316L / 1.4404 / threaded inserts in the lower part: stainless steel 316L / 1.4404 / O-Ring : EPDM / Piercing contacts: CuSn6 surface nickel and tin-plated / screws: stainless steel	27	AC2455
	4 inputs	Active CompactLine module · Metal parts from stainless steel · IR addressing possible · Version 2.11 and 3.0 with extended addressing mode · Sockets M12 x 1 · PA 6.6 / socket: stainless steel 316L / 1.4404 / threaded inserts in the lower part: stainless steel 316L / 1.4404 / O-Ring : EPDM / Piercing contacts: CuSn6 surface nickel and tin-plated / screws: stainless steel	25	AC2456



Industrial communication







Type	Inputs / outputs	Description	Draw- ing no.	Order no.
	2 outputs / 2 inputs	Active CompactLine module · 60 x 118.2 x 27 · IR addressing possible · Metal parts from stainless steel · Version 2.11 and 3.0 with extended addressing mode · Digital inputs and outputs · Sockets M12 x 1 · PA / socket: stainless steel 316L / 1.4404 / threaded inserts in the lower part: stainless steel 316L / 1.4404 / O-Ring : EPDM / screws: stainless steel / Piercing contacts: CuSn6 surface nickel and tin-plated	26	AC2485
	4 inputs	Active CompactLine module · IR addressing possible · Version 2.11 and 3.0 with extended addressing mode · Metal parts from stainless steel · Digital inputs · Sockets M12 x 1 · PA / socket: stainless steel 316L / 1.4404 / threaded inserts in the lower part: stainless steel 316L / 1.4404 / O-Ring : EPDM / screws: stainless steel / Piercing contacts: CuSn6 surface nickel and tin-plated	25	AC2486
	4 outputs	Active CompactLine module · IR addressing possible · Metal parts from stainless steel · Version 3.0 with extended addressing mode · Only for operation with AS-i masters with the profile M4 · Digital outputs · Sockets M12 x 1 · PA / socket: stainless steel 316L / 1.4404 / threaded inserts in the lower part: stainless steel 316L / 1.4404 / O-Ring : EPDM / screws: stainless steel / Piercing contacts: CuSn6 surface nickel and tin-plated	26	AC2487

Universal modules AS-Interface

Type	Inputs / outputs	Description	Draw- ing no.	Order no.
	4 inputs	Active module upper part AS-universal module · Digital inputs · Connection via cage clamps · PA6 GF30 / stainless steel	32	AC2032
	4 inputs / 4 outputs	Universal module · Digital inputs and outputs · Connection via cage clamps · PA6 GF30 / stainless steel	33	AC2035
	2 inputs 4...20 mA	Active AS-i module IP 65 · 2 analogue inputs 4...20 mA · AS-i profile S-7.3 · For the connection of 2-wire, 3-wire or 4-wire sensors · Connection via cage clamps · PBT	34	AC2616
	2 inputs 0...10 V	Active AS-i module IP 65 · 2 analogue inputs 0...10 V · AS-i profile S-7.3 · For the connection of 2-wire, 3-wire or 4-wire sensors · Connection via cage clamps · PBT	34	AC2617
	2 outputs 0...20 mA	Active AS-i module IP 65 · 2 analogue outputs 0...20 mA · AS-i profile S-7.3 · For the connection of 2-wire actuators or 4-wire actuators with separate 24 V supply · Connection via cage clamps · PBT	34	AC2618
	2 outputs 0...10 V	Active AS-i module IP 65 · 2 analogue outputs 0...10 V · AS-i profile S-7.3 · For the connection of 2-wire actuators or 4-wire actuators with separate 24 V supply · Connection via cage clamps · PBT	34	AC2619
	4 inputs Pt100	Active AS-i module IP 65 · 4 analogue inputs temperature Pt100 · AS-i profile S-7.3 · Connection via cage clamps · PBT	33	AC2620

Field modules IP 69K and accessories

Type	Inputs / outputs	Description	Draw- ing no.	Order no.
	4 inputs / 3 outputs	Active ProcessLine module · Version 2.1 with extended addressing mode · Protection rating IP 69K · high-grade stainless steel · Digital inputs and outputs · Sockets M12 x 1 · high-grade stainless steel / Makrolon / O-ring: EPDM	35	AC2904

Type	Inputs / outputs	Description	Draw- ing no.	Order no.
	8 digital inputs (2 slaves)	Active ProcessLine module · Version 2.1 with extended addressing mode · Protection rating IP 69K · high-grade stainless steel · Digital inputs · Sockets M12 x 1 · high-grade stainless steel / Makrolon / O-ring: EPDM	36	AC2910
	8-way splitter box	Passive splitter box AS-i ProcessLine · Protection rating IP 69K · high-grade stainless steel · AS-i and AUX splitter box for the connection of intelligent sensors/actuators · Sockets M12 x 1 · high-grade stainless steel / Makrolon	37	AC2900
	4 inputs 4...20 mA	Active AS-i module · 4 analogue inputs 4...20 mA · For the connection of 2-wire and 3-wire sensors · Threaded bush: stainless steel 316L / 1.4404 / Makrolon / O-ring: EPDM	38	AC2916
	4 inputs 4...20 mA	Active AS-i module · 4 analogue inputs 4...20 mA · For the connection of 2-wire, 3-wire or 4-wire sensors · Electrical isolation · Threaded bush: stainless steel 316L / 1.4404 / Makrolon / O-ring: EPDM	38	AC2923
	AS-i / 24 V	FC splitter · V4A · AS-i voltage and external auxiliary voltage via the M12 socket · Metal parts: stainless steel 316L / 1.4404 / Blanks: FPM / O-ring: EPDM	39	E70354
	AS-i	FC splitter · AS-i voltage via M12 socket · Metal parts: stainless steel 316L / 1.4404 / O-ring: EPDM / socket: PP GF30 / blade seal: TPE	40	E70454
	AS-i / 24 V	FC splitter · Metal parts: stainless steel 316L / 1.4404 / Blanks: FPM / O-ring: EPDM	41	E70377

Module lower parts









Type	Inputs / outputs	Description	Draw- ing no.	Order no.
	FC coupling module	Module lower part flat cable · AS-i interface to module upper part · Quick mounting technology for AS-i flat cable · PBT	42	AC5000
	FC-E coupling module with external power supply	FC-E coupling module · AS-i interface to module upper part · Quick mounting technology for AS-i flat cable · PBT	42	AC5003
	FC coupling module	Module lower part flat cable · with addressing plug · AS-i interface to module upper part · Quick mounting technology for AS-i flat cable · PBT	43	AC5010
	FC-E coupling module with external power supply	FC-E coupling module · with addressing plug · AS-i interface to module upper part · Quick mounting technology for AS-i flat cable · PBT	43	AC5011
	FC coupling module	Module lower part flat cable · stainless steel · AS-i interface to module upper part · Quick mounting technology for AS-i flat cable · PBT / stainless steel	42	AC5014
	FC-E coupling module with external power supply	FC-E coupling module · stainless steel · AS-i interface to module upper part · Quick mounting technology for AS-i flat cable · PBT / stainless steel	42	AC5015



Combicon connectors

Type	Description	Order no.
	Combicon connector · with screw terminals 4-pole · Housing materials: current carrying parts: copper alloy tin-plated	E70230
	Combicon connector · with screw terminals 4-pole · Housing materials: current carrying parts: copper alloy tin-plated	E70231
	Combicon connector · with cage clamps 4 poles · Housing materials: current carrying parts: copper alloy tin-plated	E70232
	Combicon connector · with cage clamps 4 poles · Housing materials: current carrying parts: copper alloy tin-plated	E70233
	Combicon connector · with insulation displacement terminals 4-pole (0.75...1 mm ²) · Housing materials: current carrying parts: copper alloy tin-plated	E70236

Flat cable splitters and accessories

Type	Description	Order no.
	Quad M12 · AS-i and external voltage via M12 socket · Sockets M12 x 1 · Housing materials: PA66 / socket: stainless steel 316L / 1.4404 / screws: stainless steel 316L / 1.4404 / nut: stainless steel 316L / 1.4404 / O-Ring : NBR / Flat cable seal: NBR	E70588
	Quad splitter · Distribution of the AS-i voltage or the external 24 V supply · Housing materials: PA66 / screws: stainless steel 316L / 1.4404 / nuts: stainless steel 316L / 1.4404 / Flat cable seal: NBR	E70600
	FC splitter · Distribution of the AS-i voltage or the external 24 V supply · Housing materials: PA 6 GF35 Grivory	E70381
	FC splitter · high-grade stainless steel · ATEX approval · Group II, category 3D/3G · AS-i voltage and external auxiliary voltage via the M12 socket · Housing materials: Metal parts: stainless steel 316L / 1.4404 / Blanks: FPM / O-ring: EPDM	E7354A
	FC splitter · ATEX approval · Group II, category 3D/3G · Distribution of the AS-i voltage or the external 24 V supply · Housing materials: Metal parts: stainless steel 316L / 1.4404 / Blanks: FPM / O-ring: EPDM	E7377A
	FC insulation displacement connector · AS-i voltage via M12 socket · Keyway bottom left · Housing materials: PA66 - GF25	E70485
	FC insulation displacement connector · AS-i voltage via M12 socket · Keyway top right · Housing materials: PA66 - GF25	E70486
	FC insulation displacement connector · AS-i and external voltage via M12 socket · Housing materials: PA66 - GF25	E70487

Type	Description	Order no.
	FC splitter · Distribution of the AS-i voltage or the external 24 V supply · Housing materials: PBT / screw: stainless steel / Contact pins: gold-plated	E70581
	FC insulation displacement connector · Distribution of the AS-i voltage and the external 24 V supply to M12 socket · 1 m · Housing materials: housing: PBT PC / cable: PUR / connector housing: PUR	E70582
	FC insulation displacement connector · AS-i voltage via M12 socket · Keyway top right · Housing materials: PBT PC	E70585
	FC insulation displacement connector · AS-i voltage via M12 socket · Keyway bottom left · Housing materials: PBT PC	E70586
	FC insulation displacement connector · Socket M12 - AS-i flat cable · Housing materials: sealing: NBR / housing: PA / O-ring: FPM / screws: stainless steel / nut: Brass nickel-plated / Contact pins: bronze gold-plated	AC5005
	FC insulation displacement connector · Socket M12 - AS-i flat cable · 2 connection directions possible in case of angled connectors · Housing materials: sealing: EPDM / housing: PA / O-ring: EPDM / screws: stainless steel / nut: stainless steel / Contact pins: bronze gold-plated	E70471
	FC insulation displacement connector · Socket M12 - AS-i flat cable · Housing materials: PA	E70096
	FC insulation displacement connector · Distribution of the AS-i voltage and the external 24 V supply to M12 socket · 1 m · Housing materials: housing: PA 6 GF35 Grivory / Socket: PUR	E70481
	FC insulation displacement connector · Distribution of the AS-i voltage to M12 socket · 0.6 m · Housing materials: housing: PA66 - GF25	E70483
	FC insulation displacement connector · Transition from flat cable to round cable · Cable length 2 m · 2 m · Housing materials: PA 6 GF35 Grivory / round cable: PUR / core insulation: PVC	E70498
	FC insulation displacement connector · Transition from flat cable to round cable · Cable length 5 m · 5 m · Housing materials: PA 6 GF35 Grivory / round cable: PUR / core insulation: PVC	E70499
	Flat cable insulation displacement connector	E79995
	FC insulation displacement connector · straight / angled	E79998
	Splitter box · 8 way · Cable · 25 m · Housing materials: high-grade stainless steel	E11847
	Y splitter · M12 plug - 2 M8 sockets · Free from halogen · Free from silicone · Gold-plated contacts · Housing materials: PUR	E10802

















Industrial communication

Type	Description	Order no.
	Passive AS-i bus termination · Improvement of the signal quality · Extension of the cable without additional repeater · Monitoring of the supply voltage by means of LEDs	E70580
	Protective cap · M8 · for CompactM8 modules · Housing materials: ULTRAMID black	E73005
	Protective cap · M12 · for M12 sockets of ClassicLine modules, CompactLine modules and AirBoxes · Housing materials: PA black	E73004
	Protective cap · M12 · for M12 socket to cover the unused inputs and outputs on the module; for unused inputs of splitter boxes · for ProcessLine modules · Housing materials: PP	E70297
	Connector for analogue modules · for AC5222, AC5223, AC2516, AC2566 · Housing materials: PVC	E75222
	Hutschienenhalter · for PCB module AC2750...53 · Housing materials: screws: galvanised / DIN rail adapter: AlMgSi0.5 F22 / mounting clip: C100S+QT galvanised	E70432
	Cable clip for fixing the AS-i flat cable · flat cable · Housing materials: 301 / 1.4310	E70442
	Combicon connector · 1x4-pole twin connector with cage clamp connection · type 1.5/4-ST BK 0.2...1.5 mm ² (AWG 24...16) · Double terminal · Housing materials: current carrying parts: copper alloy tin-plated	E70440
	Wall passage · M12 connector · Housing materials: Brass nickel-plated / sealing: FKM	E73008
	Wall passage · M12 connector · Housing materials: stainless steel 303/1.4305 / sealing: EPDM	E73009
	DIN rail adapter · for CompactM8 modules · Housing materials: Mounting plate: stainless steel / DIN rail clip: stainless steel / Threaded bush: high-grade st. steel	E73006
	DIN rail adapter · for CompactM8 modules · Housing materials: Mounting plate: stainless steel / DIN rail clip: stainless steel / Threaded bush: high-grade st. steel	E73007







Accessories lower parts and addressing units

Type	Description	Order no.
	AS-i addressing unit · AS-i version 3.0 with extended addressing mode	AC1154

Type	Description	Order no.
	Addressing cable · for AS-i slaves · 1.6 m	E70213
	Addressing cable	E70423
	Addressing cable · 1 m · black	E70211
	Programming cable for controller E · Western connector RJ11 6 poles / D-Sub socket 9 poles · 1.55 m · grey	E70320
	Screw terminal insert for AC5101/AC5031 for additional 24 V supply	AC5007
	impact protection housing · for ATEX ClassicLine modules and ATEX AirBoxes · Housing materials: housing: stainless steel / button head hexagon socket screw: stainless steel	E7000A
	Use of the lower part as branching box · Housing materials: plastics	AC3000
	AS-i flat cable · Reverse polarity protection due to special shape · for use of insulation displacement technology · 100 m · PUR, halogen-free · yellow	E74100
	AS-i flat cable · Reverse polarity protection due to special shape · for use of insulation displacement technology · 100 m · PUR, halogen-free · black	E74110
	AS-i flat cable · Reverse polarity protection due to special shape · for use of insulation displacement technology · 100 m · EPDM, halogen-free · yellow	E74000
	AS-i flat cable · Reverse polarity protection due to special shape · for use of insulation displacement technology · 100 m · EPDM, halogen-free · black	E74010
	AS-i flat cable · Reverse polarity protection due to special shape · for use of insulation displacement technology · 100 m · TPE · yellow	E74200
	AS-i flat cable · Reverse polarity protection due to special shape · for use of insulation displacement technology · 100 m · TPE · black	E74210
	AS-i flat cable · Reverse polarity protection due to special shape · for the food industry · for use of insulation displacement technology · 100 m · TPE-PVC compound · yellow	E74300
	AS-i flat cable · Reverse polarity protection due to special shape · for the food industry · for use of insulation displacement technology · 100 m · TPE-PVC compound · black	E74310



Industrial communication

Type	Description	Order no.
	JOKARI flat cable stripping tool	E70062
	Flat cable blank · Length: 60 mm · to cover the unused cable entry · for FC splitter E70354 · Housing materials: silicone rubber blue	E70299
	Flat cable blank · Length: 60 mm · to cover the unused cable entry · for CompactLine modules (AC24xx), ClassicLine modules (AC52xx) or AirBoxes (AC52xx) · Housing materials: EPDM black	E70399
	Heat-shrink cap · for sealing the flat cable ends · Housing materials: plastics	E70113
	Flat cable seal · Housing materials: ULTRAMID / sealing: NBR	E70413
	Cable clip for fixing the AS-i flat cable · Housing materials: PA 6.6	E70067
	Torque wrench	E70390

Scale drawings / drawing no. – CAD download: www.ifm.com

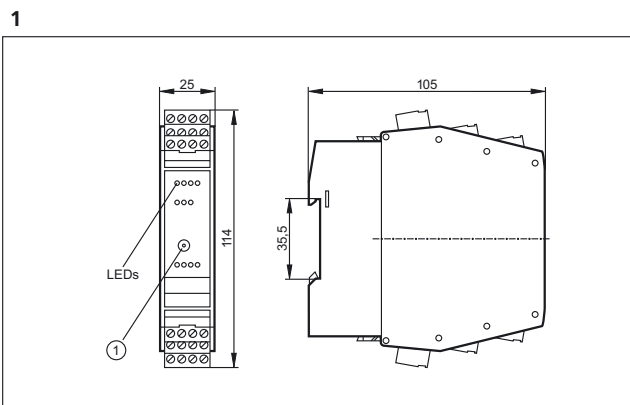

1: Addressing socket

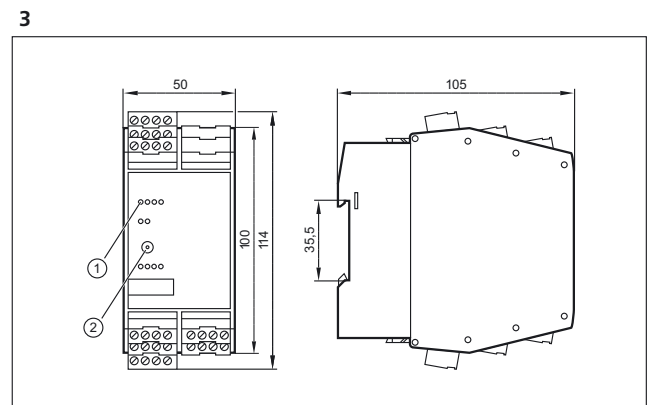

1: LED, 2: Addressing socket

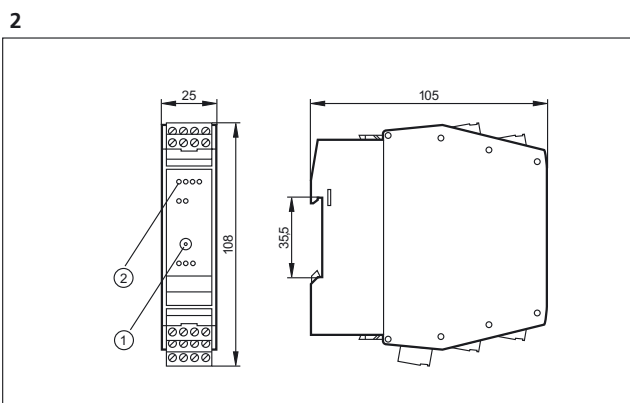

1: Addressing socket, 2: LED

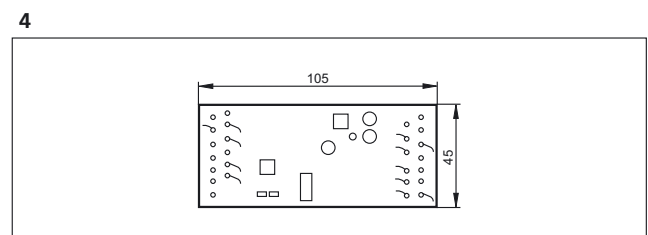

Scale drawings / drawing no. – CAD download: www.ifm.com

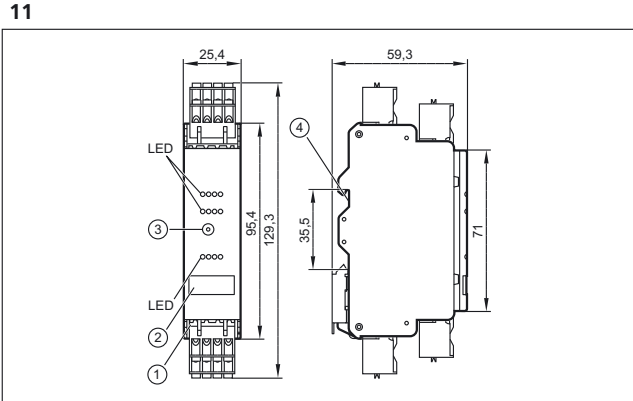
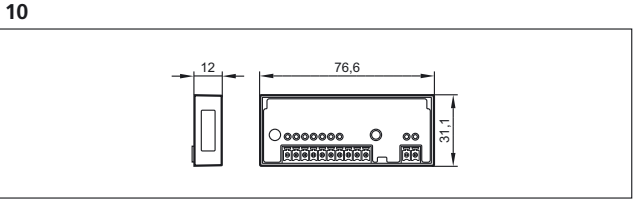
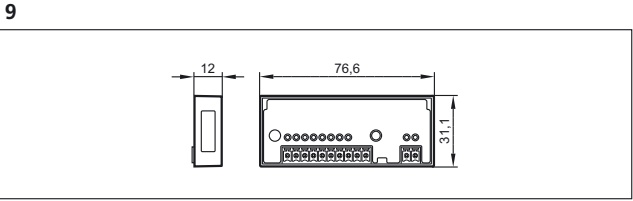
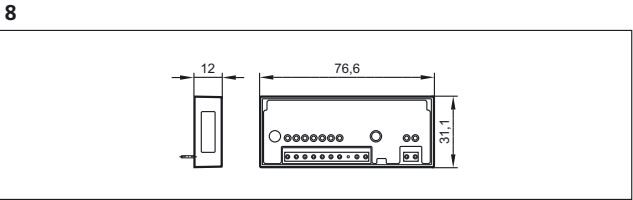
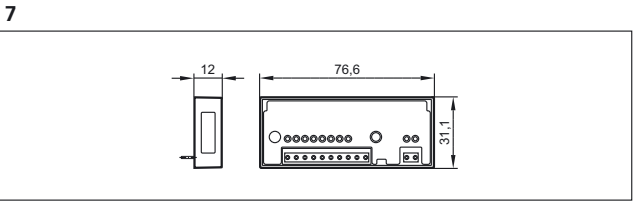
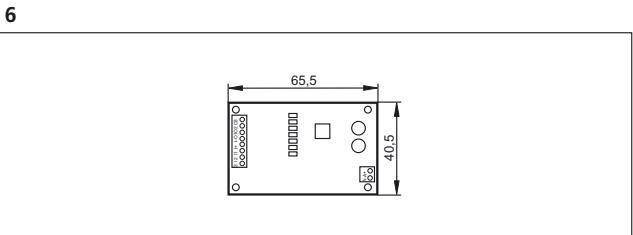
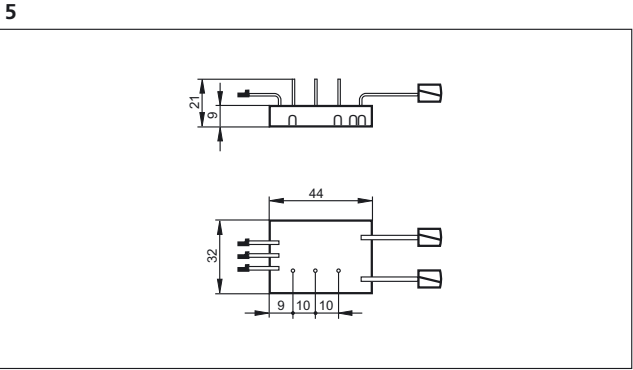

1: Plug with cage clamp connection, 2: label, 3: Addressing socket, 4: DIN rail adapter

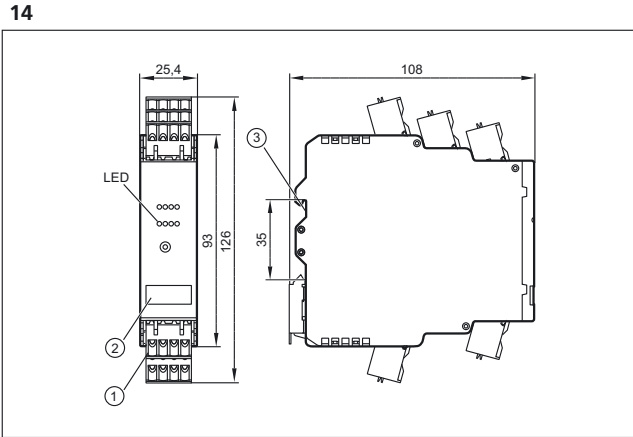
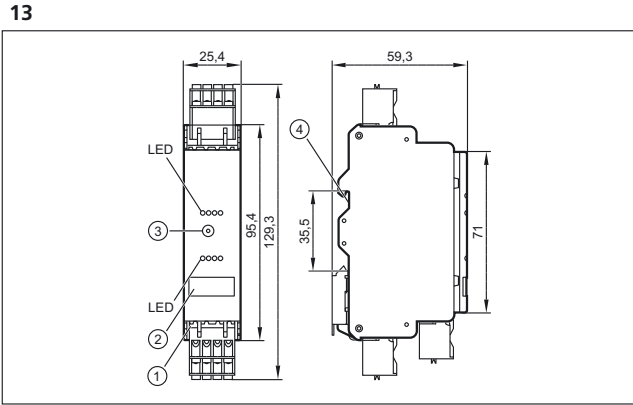
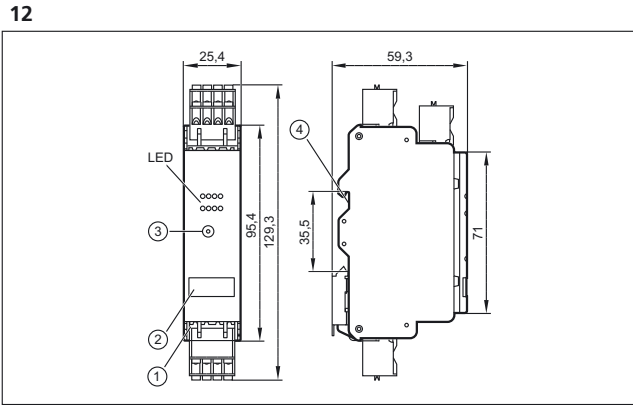



Scale drawings / drawing no. – CAD download: www.ifm.com

15

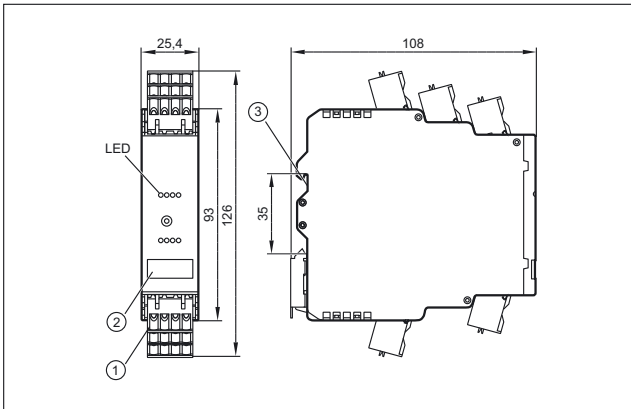

19

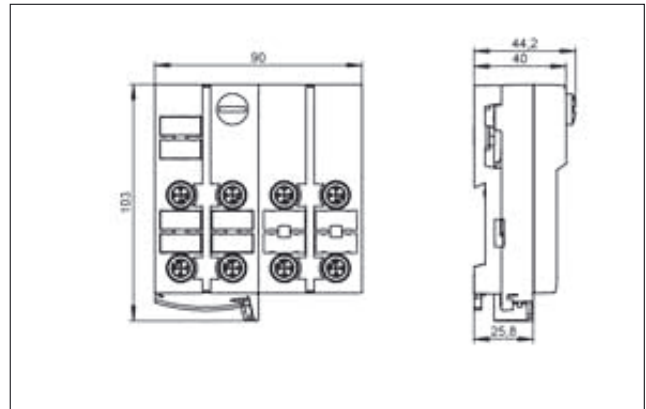

16

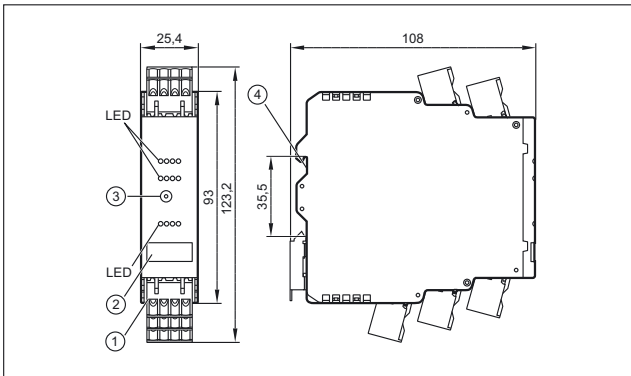

20

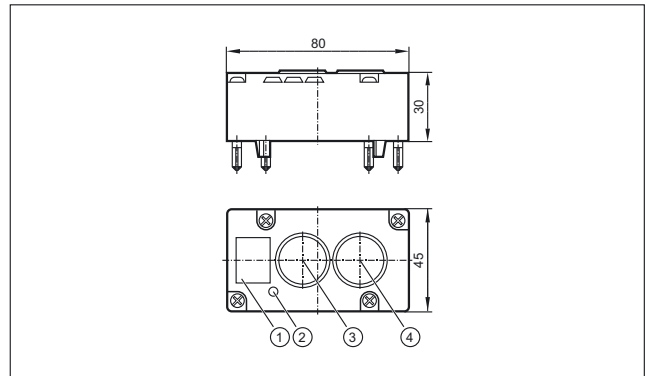

1: Plug with cage clamp connection, 2: label, 3: Addressing socket, 4: Mounting on DIN rail

17

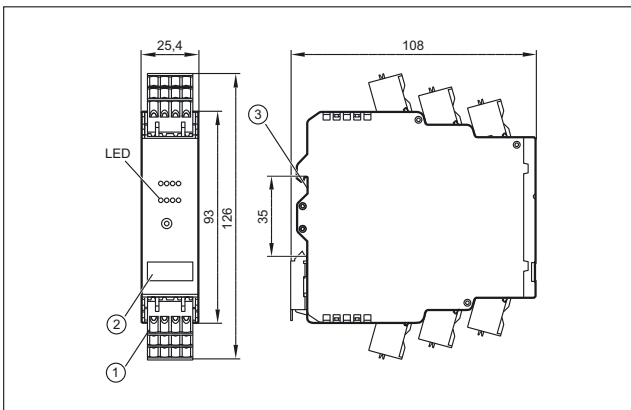

21

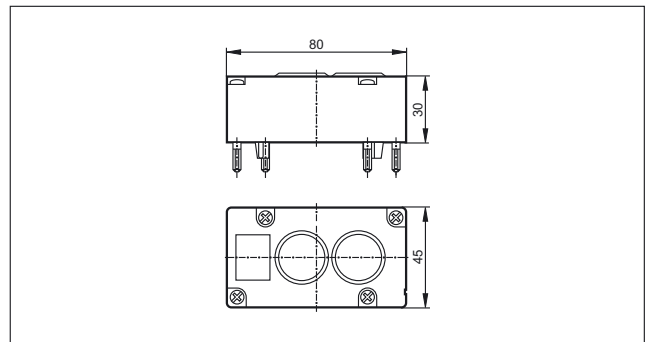

18

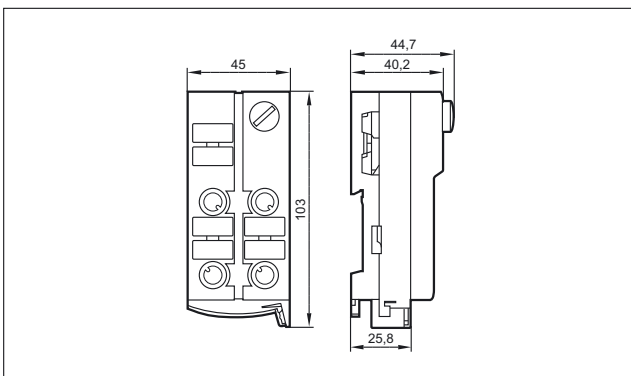

22

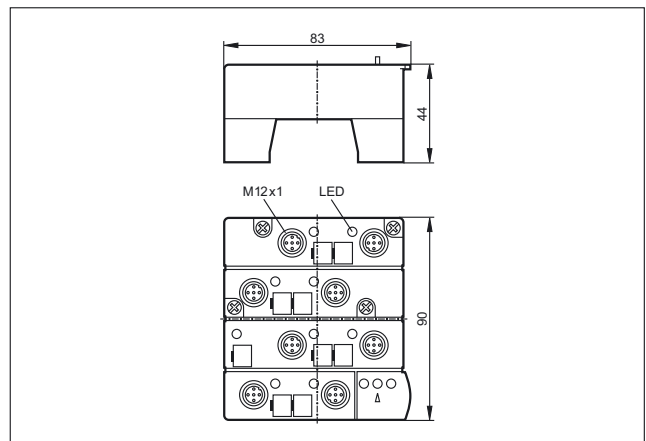

Scale drawings / drawing no. – CAD download: www.ifm.com

23

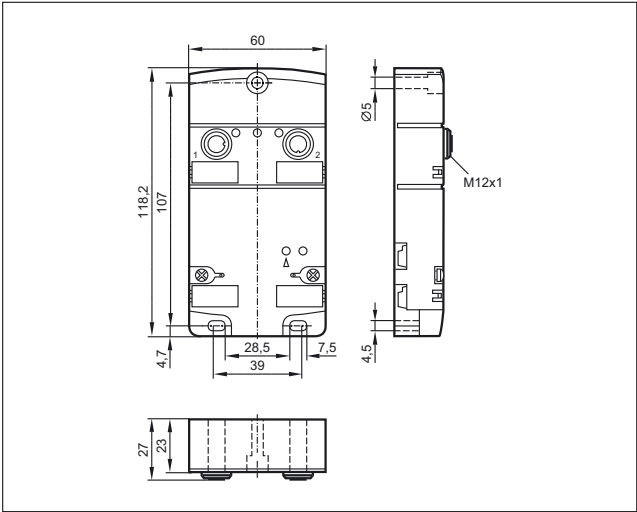

26

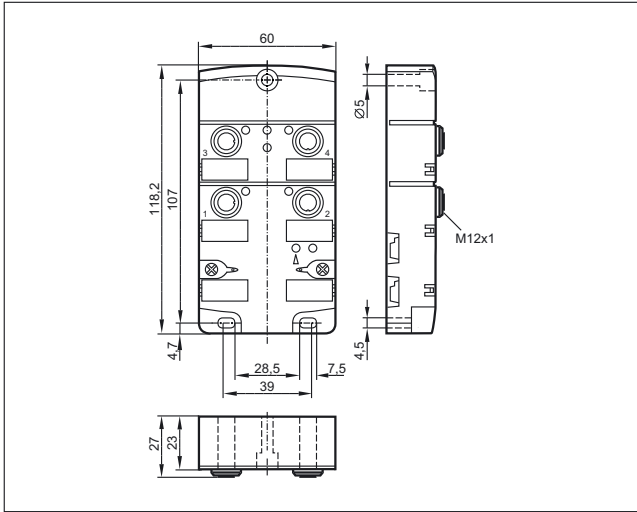

24

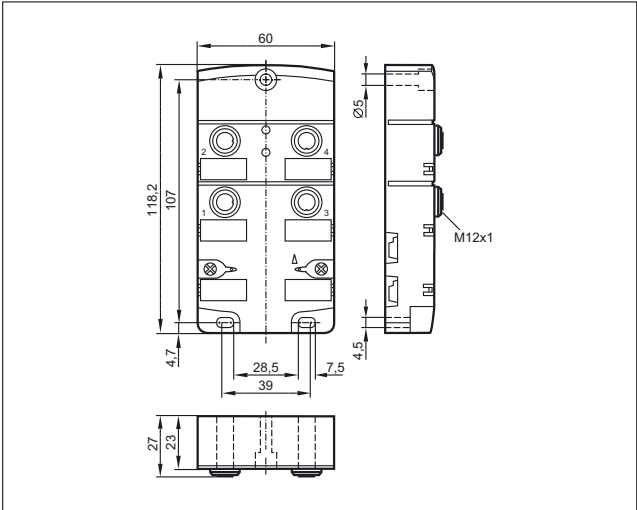

27

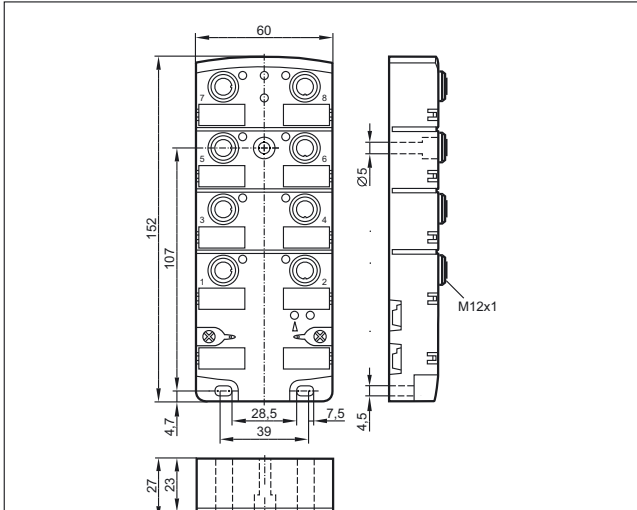

25

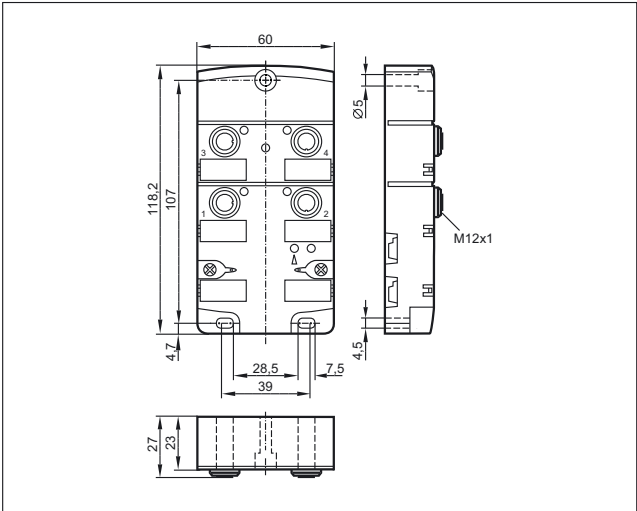

28

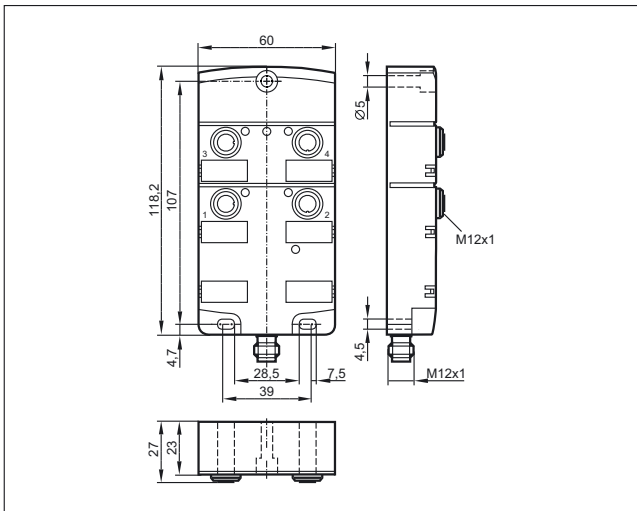



Scale drawings / drawing no. – CAD download: www.ifm.com

29

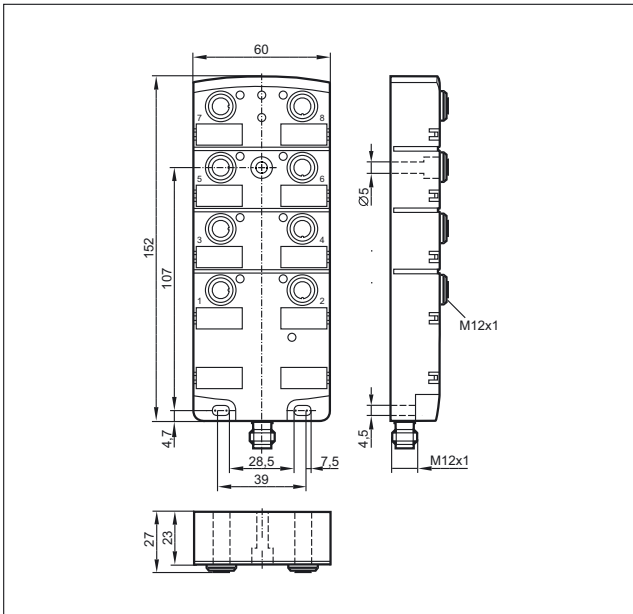

33

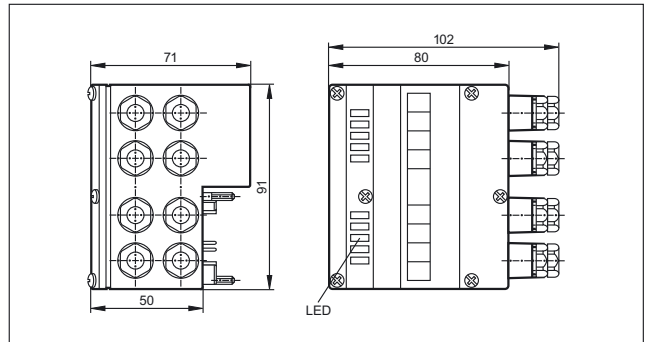

34

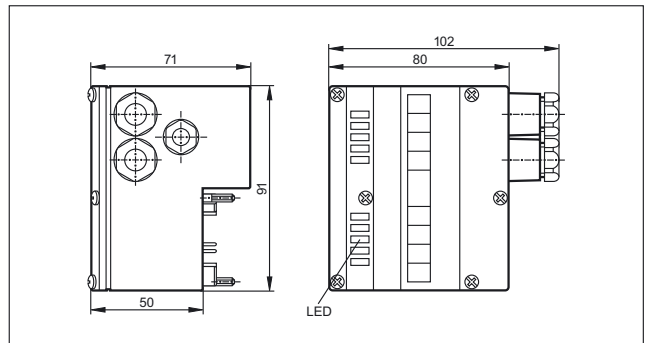

30

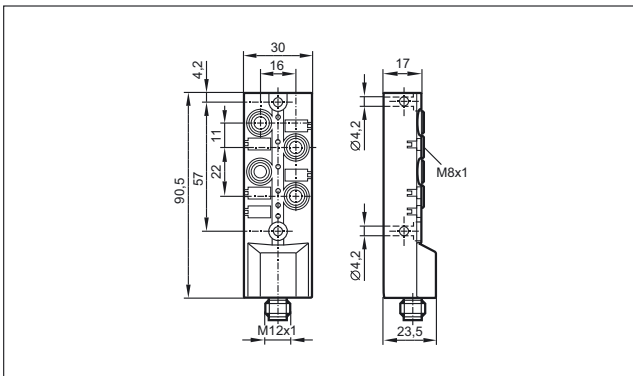

35

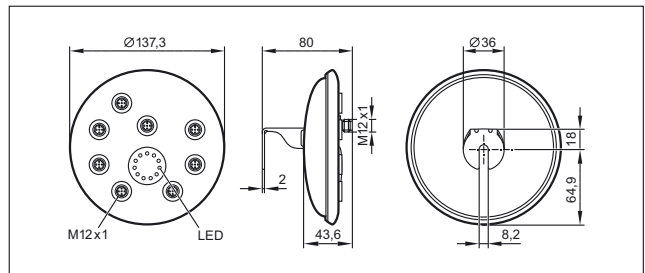

31

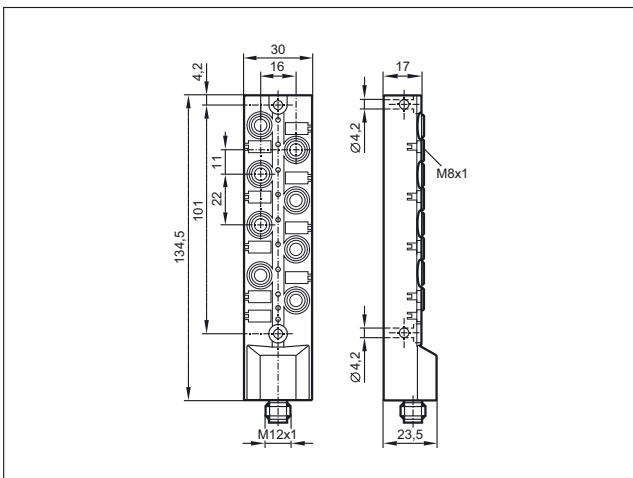

36

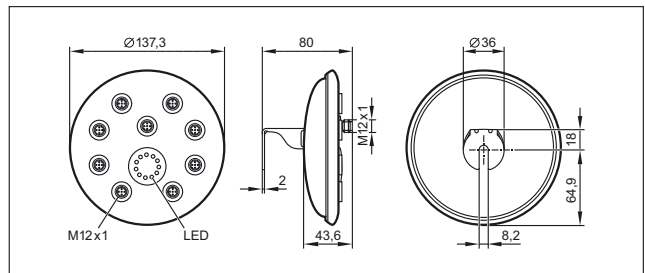

32

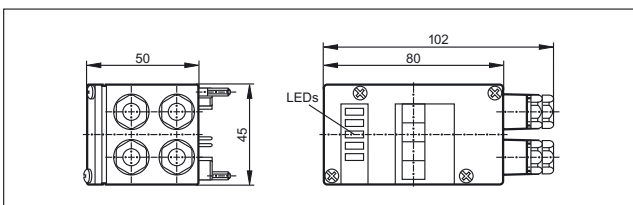

37

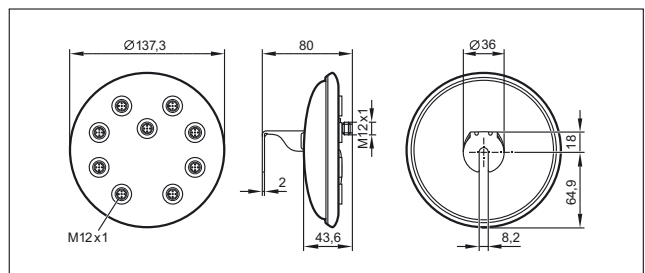

Scale drawings / drawing no. – CAD download: www.ifm.com

38

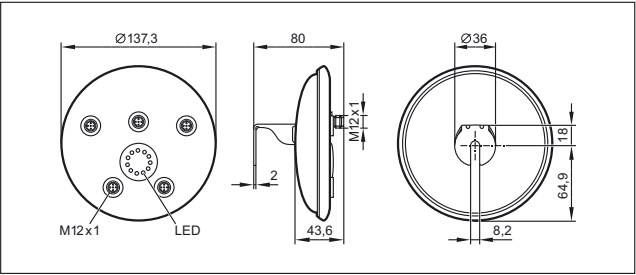

39

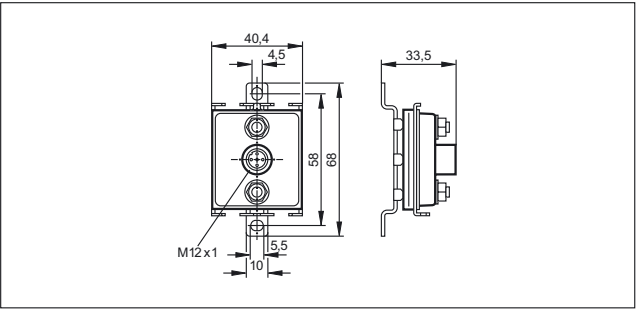

40

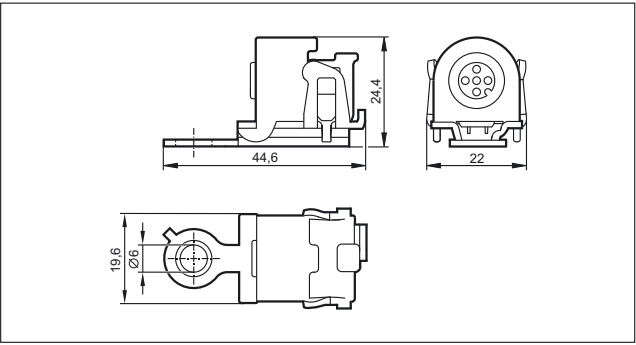

41

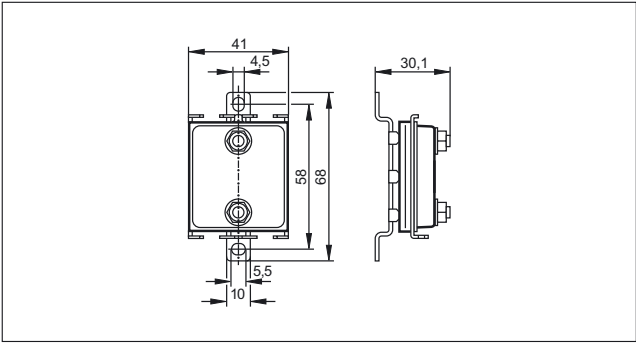

42

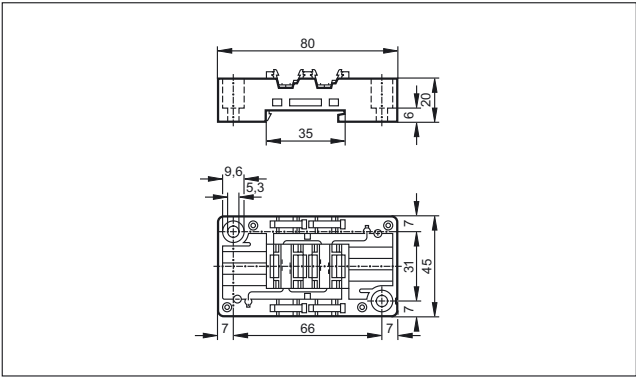

43

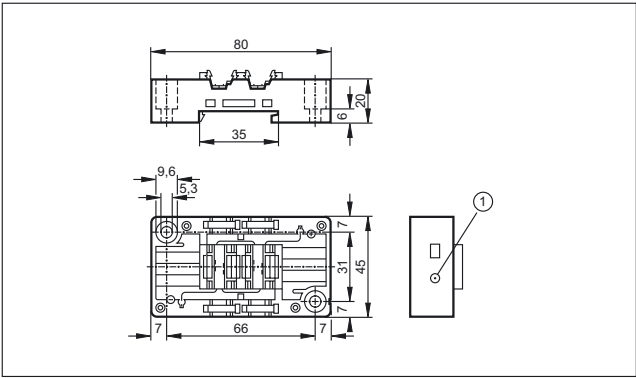

1: Addressing socket



Industrial communication





AS-Interface AirBoxes for pneumatics

The AS-i AirBoxes are compact pneumatic valves, complemented by digital feedback inputs. They are integrated in a ClassicLine housing and are compatible in terms of space and mounting. The AS-i connection is carried out via the common flat cable or round cable lower parts. 3/2-way, 4/2-way, 5/2-way and 5/3-way valves are available.

System overview	Page
Pneumatic solutions (quick mounting)	630 - 631
Pneumatic solutions (ATEX)	631
Pneumatic solutions (screw mounting)	632
Accessories pneumatic components	632
Scale drawings / drawing no. – CAD download: www.ifm.com	633

Pneumatic solutions (quick mounting)

Type	Inputs / outputs	Description	Draw- ing no.	Order no.
	2 inputs / 2 outputs; AirBox supply via AS-i	AS-i AirBox · 2 x 3/2-way slide valves free from overlapping · monostable · Three orientations of the flat cable are possible · AS-i flat cable connection · Addressing socket · AS-i profile S-3.F.F · PA / POM / Piercing contacts: CuSn6 surface nickel and tin-plated	1	AC5227
	4 inputs / 2 outputs; AirBox supply via AS-i	AS-i AirBox · 2 x 3/2-way slide valves free from overlapping · monostable · Three orientations of the flat cable are possible · AS-i flat cable connection · Version 2.11 and 3.0 with extended addressing mode · Addressing socket · PA / POM / Piercing contacts: CuSn6 surface nickel and tin-plated	1	AC5228
	4 inputs / 2 outputs; AirBox supply via external 24 V DC	AS-i AirBox · 2 x 3/2-way slide valves free from overlapping · monostable · Three orientations of the flat cable are possible · AS-i flat cable connection · Version 2.11 and 3.0 with extended addressing mode · Addressing socket · PA / POM / Piercing contacts: CuSn6 surface nickel and tin-plated	1	AC5243
	4 inputs / 1 output ; AirBox supply via AS-i	AS-i AirBox · 5/2-way slide valve free from overlapping · monostable · Three orientations of the flat cable are possible · AS-i flat cable connection · Version 2.11 and 3.0 with extended addressing mode · Addressing socket · PA / POM / Piercing contacts: CuSn6 surface nickel and tin-plated	2	AC5246
	4 inputs / 1 output; AirBox supply via external voltage 24 V DC	AS-i AirBox · 5/2-way slide valve free from overlapping · monostable · Three orientations of the flat cable are possible · AS-i flat cable connection · Version 2.11 and 3.0 with extended addressing mode · Addressing socket · PA / POM / Piercing contacts: CuSn6 surface nickel and tin-plated	2	AC5249
	4 inputs / 2 outputs; AirBox supply via AS-i	AS-i AirBox · 5/2-way bistable slide valve free from overlapping · Three orientations of the flat cable are possible · AS-i flat cable connection · Version 2.11 and 3.0 with extended addressing mode · Addressing socket · PA / POM / Piercing contacts: CuSn6 surface nickel and tin-plated	1	AC5251

Type	Inputs / outputs	Description	Drawing no.	Order no.
	4 inputs / 2 outputs; AirBox supply via external 24 V DC	AS-i AirBox · 5/2-way bistable slide valve free from overlapping · Three orientations of the flat cable are possible · AS-i flat cable connection · Version 2.11 and 3.0 with extended addressing mode · Addressing socket · PA / POM / Piercing contacts: CuSn6 surface nickel and tin-plated	1	AC5253
	4 inputs / 2 outputs; AirBox supply via AS-i	AS-i AirBox · 5/3-way slide valve free from overlapping · closed · Three orientations of the flat cable are possible · AS-i flat cable connection · Version 2.11 and 3.0 with extended addressing mode · Addressing socket · PA / POM / Piercing contacts: CuSn6 surface nickel and tin-plated	1	AC5270
	4 inputs / 2 outputs; AirBox supply via external 24 V DC	AS-i AirBox · 5/3-way slide valve free from overlapping · closed · Three orientations of the flat cable are possible · AS-i flat cable connection · Addressing socket · Version 2.11 and 3.0 with extended addressing mode · PA / POM / Piercing contacts: CuSn6 surface nickel and tin-plated	1	AC5271

Pneumatic solutions (ATEX)

Type	Inputs / outputs	Description	Drawing no.	Order no.
	4 inputs / 2 outputs; AirBox supply via AS-i	AS-i AirBox · 2 x 3/2-way slide valves free from overlapping · monostable · Three orientations of the flat cable are possible · AS-i flat cable connection · Digital inputs · Addressing socket · AS-i profile S-7.F.F · Versions 2.11 and 3.0 · ATEX approval · Group II, category 3D · Only in conjunction with impact protection housing E7000A or equivalent protection · PA / POM / Piercing contacts: CuSn6 surface nickel and tin-plated	1	AC542A
	4 inputs / 2 outputs; AirBox supply via AS-i	AS-i AirBox · 2 x 3/2-way slide valves free from overlapping · Three orientations of the flat cable are possible · AS-i flat cable connection · Version 2.11 and 3.0 with extended addressing mode · Addressing socket · ATEX approval · Group II, category 3D · Only in conjunction with impact protection housing E7000A or equivalent protection · PA / POM / Piercing contacts: CuSn6 surface nickel and tin-plated	1	AC528A
	4 inputs / 1 output ; AirBox supply via AS-i	AS-i AirBox · 5/2-way slide valve free from overlapping · monostable · Three orientations of the flat cable are possible · AS-i flat cable connection · Version 2.11 and 3.0 with extended addressing mode · Addressing socket · ATEX approval · Group II, category 3D · Only in conjunction with impact protection housing E7000A or equivalent protection · PA / POM / Piercing contacts: CuSn6 surface nickel and tin-plated	2	AC546A
	2 inputs / 1 output; AirBox supply via AS-i	AS-i AirBox · 5/2-way slide valve free from overlapping · monostable · Three orientations of the flat cable are possible · AS-i flat cable connection · Digital inputs · Addressing socket · AS-i profile S-3.F.F · ATEX approval · Group II, category 3D · Only in conjunction with impact protection housing E7000A or equivalent protection · PA / POM / Piercing contacts: CuSn6 surface nickel and tin-plated	1	AC246A
	4 inputs / 2 outputs; AirBox supply via AS-i	AS-i AirBox · 5/2-way bistable slide valve free from overlapping · Three orientations of the flat cable are possible · AS-i flat cable connection · Version 2.11 and 3.0 with extended addressing mode · Addressing socket · ATEX approval · Group II, category 3D · Only in conjunction with impact protection housing E7000A or equivalent protection · PA / POM / Piercing contacts: CuSn6 surface nickel and tin-plated	1	AC551A
	4 inputs / 2 outputs; AirBox supply via AS-i	AS-i AirBox · 5/3-way slide valve free from overlapping · closed · Three orientations of the flat cable are possible · AS-i flat cable connection · Version 2.11 and 3.0 with extended addressing mode · Addressing socket · ATEX approval · Group II, category 3D · Only in conjunction with impact protection housing E7000A or equivalent protection · PA / POM / Piercing contacts: CuSn6 surface nickel and tin-plated	1	AC570A



Pneumatic solutions (screw mounting)

Type	Inputs / outputs	Description	Draw- ing no.	Order no.
	2 x 2 inputs / 2 outputs	AS-i AirBox · Connection to the pneumatic system by tube fittings · Manual override by pressing/releasing or pressing/turning/locking · 2 x 2 digital inputs · 2 pneumatic outputs · Sockets M12 x 1 · housing: PBT / Metal parts: stainless steel / sealing: Viton	3	AC2055
	2 inputs / 1 output NO/NC selectable (monostable)	AS-i AirBox · Connection to the pneumatic system by tube fittings · 1 x 2 or 2 x 1 digital inputs · 1 pneumatic output (NO/NC selectable) · Sockets M12 x 1 · housing: PBT / Metal parts: stainless steel / sealing: Viton	4	AC2057

Accessories pneumatic components

Type	Description	Order no.
	Silencer · Housing materials: connection piece: PP / filter: PE	E75232
	Push-in T-fitting · Housing materials: housing: Nickel-plated brass / PA66 / tooth lock washer: stainless steel	E75227
	Push-in L-fitting · Housing materials: housing: PA66 / release ring: polyoxymethylene / tooth lock washer: stainless steel / form ring: acrylonitrile butadiene caoutchouc	E75228
	Push-in L-fitting · Diameter reduction from Ø8 mm to Ø6 mm · Housing materials: housing: Nickel-plated brass / PA66 / tooth lock washer: stainless steel	E75229
	Sealing plug for AirBox · Housing materials: housing: PA66	E75231

Scale drawings / drawing no. – CAD download: www.ifm.com

1

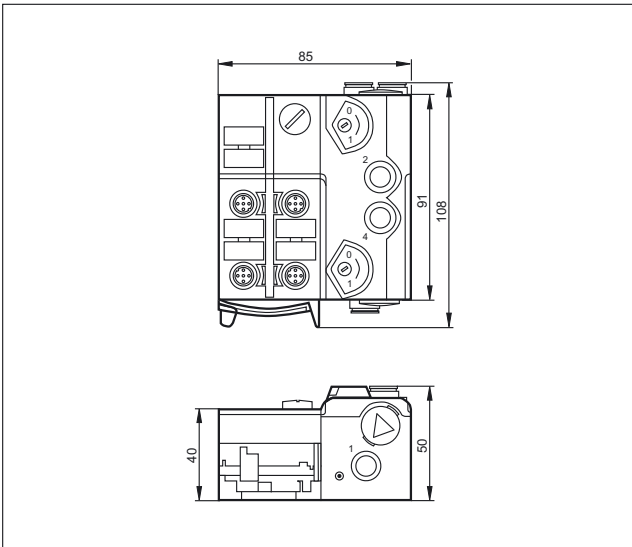

2

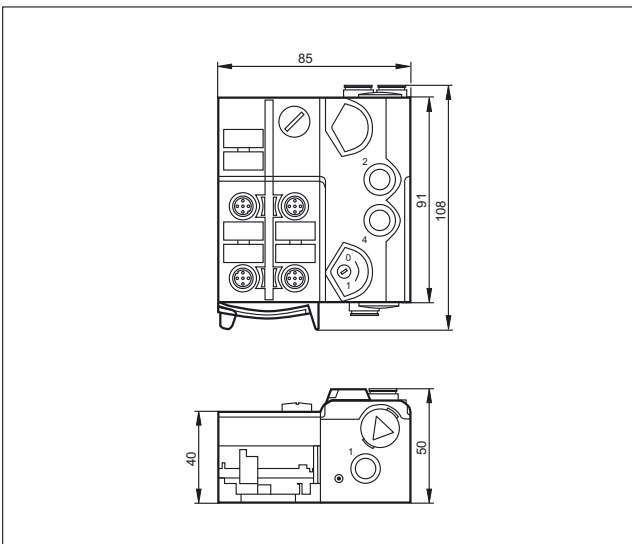

3

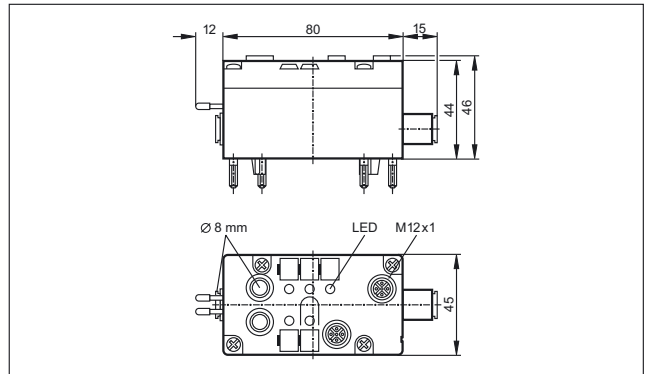

4

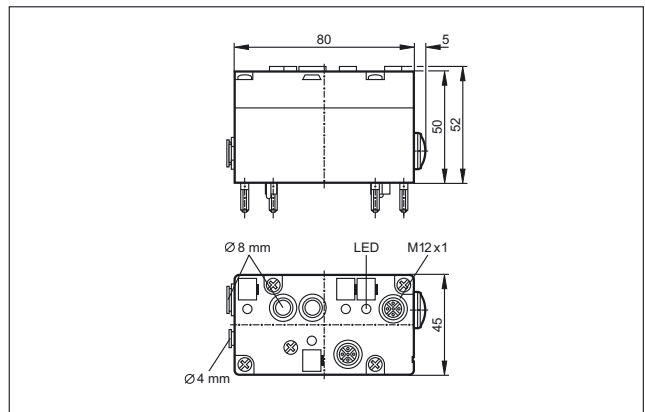



Industrial communication







AS-Interface sensors

The bus connection is already integrated in the intelligent AS-i sensors. So they can be directly connected to the yellow cable. In addition to the pure sensor information, further diagnostic data are available via the AS-interface, which can be transmitted and evaluated at a low cost.

System overview	Page
AS-i sensors	634 - 635
Scale drawings / drawing no. – CAD download: www.ifm.com	635 - 636

AS-i sensors

Type	Description	Draw- ing no.	Order no.
	Inductive sensor · M12 x 1 · Sensing range 4 mm · Gold-plated contacts · Connector, Gold-plated contacts · stainless steel / active face: LCP uncoloured	1	IFC247
	Inductive sensor · M12 x 1 · Sensing range 7 mm · Gold-plated contacts · Connector, Gold-plated contacts · stainless steel / active face: LCP uncoloured	2	IFC248
	Inductive sensor · M18 x 1 · Sensing range 8 mm · Gold-plated contacts · Connector, Gold-plated contacts · threaded sleeve: stainless steel / active face: LCP uncoloured / lock nuts: Brass	3	IGC234
	Inductive sensor · M18 x 1 · Sensing range 12 mm · Gold-plated contacts · Connector, Gold-plated contacts · threaded sleeve: stainless steel / active face: LCP uncoloured / lock nuts: Brass	4	IGC235
	Inductive sensor · M30 x 1.5 · Sensing range 14 mm · Gold-plated contacts · Connector, Gold-plated contacts · stainless steel / active face: LCP uncoloured	5	IIC220
	Inductive sensor · M30 x 1.5 · Sensing range 22 mm · Gold-plated contacts · Connector, Gold-plated contacts · stainless steel / active face: LCP uncoloured	6	IIC221
	Inductive sensor · Sensing range 15 mm · 5 positions of the sensing face selectable · Connector, rotatable, locking · PBT / PPE	7	IM5118
	Read/write head · With integrated AS-i slave profile 7.4 · M12 connector · rotatable · PA	8	DTA100
	Read head · with integrated AS-i slave profile 7.3 · M12 connector · rotatable · PA	8	DTA101
	Read/write head · With integrated AS-i slave profile 7.4 · M12 connector · 5 positions of the sensing face selectable · rotatable, locking · PA	7	DTA200

Type	Description	Drawing no.	Order no.
	Read head · with integrated AS-i slave profile 7.3 · M12 connector · 5 positions of the sensing face selectable · rotatable, locking · PA	7	DTA201
	Read/write head · With integrated AS-i slave profile 7.4 · M12 connector · rotatable · housing: PPE / Metal parts: diecast zinc / brass nickel-plated	9	DTA300
	Read head · with integrated AS-i slave profile 7.3 · M12 connector · rotatable · housing: PPE / Metal parts: diecast zinc / brass nickel-plated	9	DTA301

Scale drawings / drawing no. – CAD download: www.ifm.com

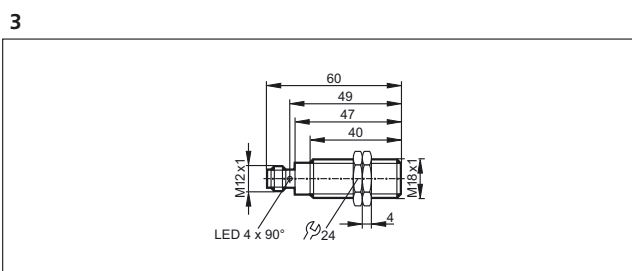
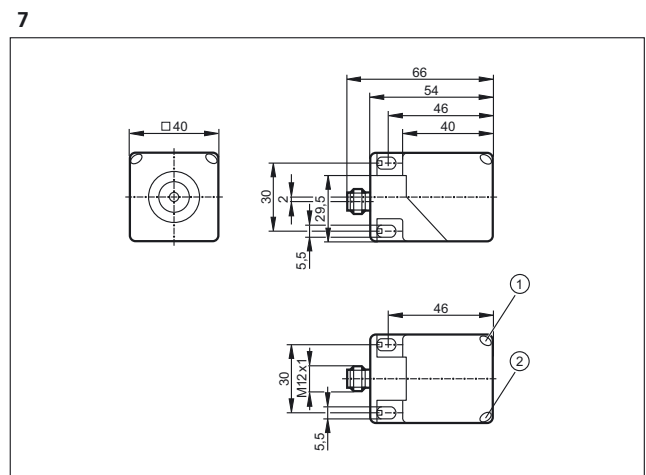
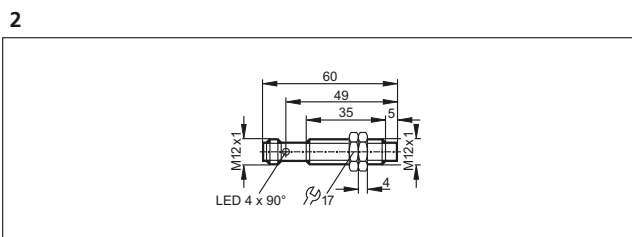
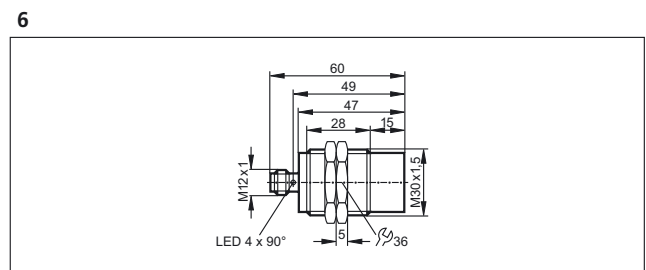
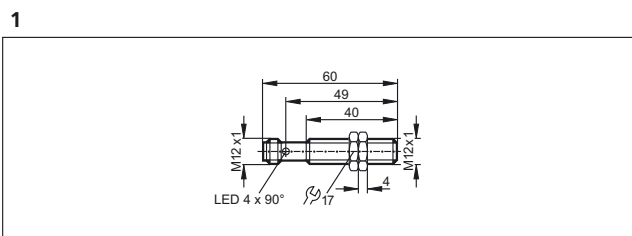

1: LED yellow, 2: LED green

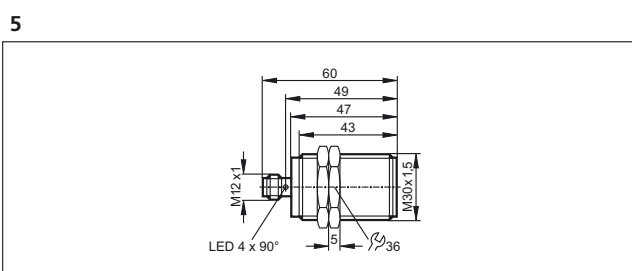
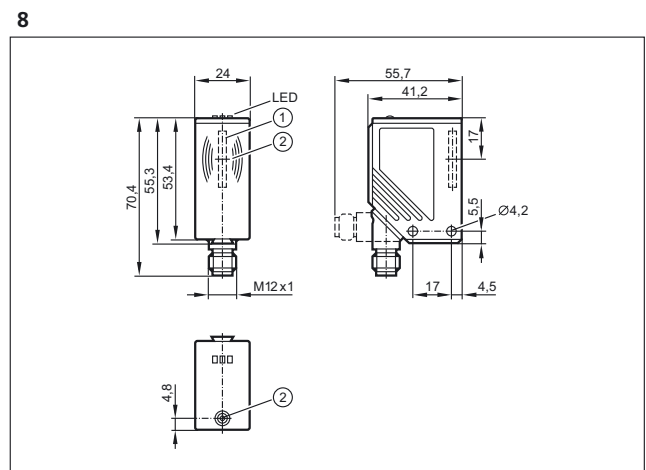
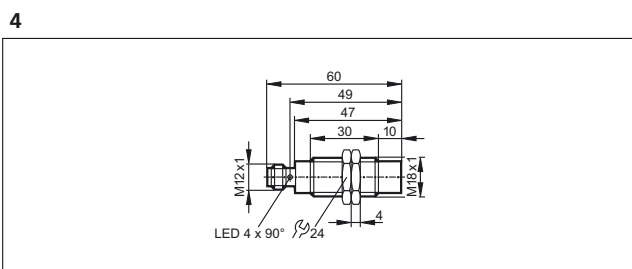

1: integrated antenna, 2: tag positioning mark (middle of the antenna)



Scale drawings / drawing no. – CAD download: www.ifm.com

9

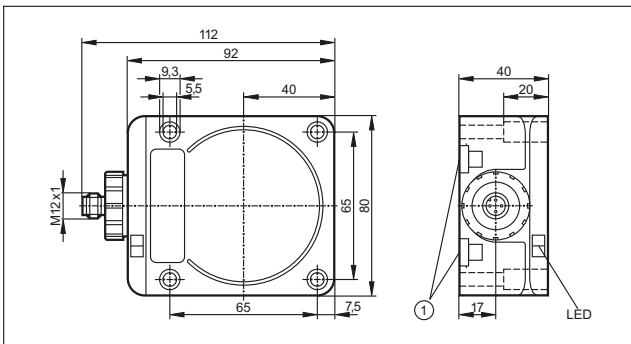

1: Mounting on DIN rail





Industrial communication





AS-Interface devices for valves and valve actuators

The valve controls for pneumatic quarter-turn actuators can be directly mounted to most quarter-turn actuators by means of the standardised mechanical interface. They contain two inductive sensors for position feedback, one or two outputs for the control of the pilot valve, and an AS-i slave.

System overview	Page
Sensors with ATEX approval 3D and / or 3G	638
Sensors for industrial applications, AS-i system	638 - 639
Wiring diagrams	639
Scale drawings / drawing no. – CAD download: www.ifm.com	639 - 640

Sensors with ATEX approval 3D and / or 3G

Type	Dimensions [mm]	Sensing range [mm]	Material	U _b [V]	Protection	f AC / DC [Hz]	I _{load} AC / DC [mA]	Draw- ing no.	Order no.
M12 connector · Output function transistor PNP · 2 inputs / 2 outputs · Connector groups 196, 198									
	55 x 60 x 35	4	PBT	26.5...31.6	IP 5x	–	–	1	AC327A
M12 connector · Output function transistor PNP · 2 inputs / 1 output · Connector groups 196, 198									
	55 x 60 x 35	4	PBT	26.5...31.6	IP 5x	–	–	1	AC336A

Sensors for industrial applications, AS-i system

Type	Dimensions [mm]	Sensing range [mm]	Material	U _b [V]	Protection	f AC / DC [Hz]	I _{load} AC / DC [mA]	Draw- ing no.	Order no.
M12 connector · Output function transistor PNP · AS-i · Wiring diagram no. 1 · Connector groups 8, 10, 19, 21, 23, 25, 44, 148, 149, 153, 159, 160, 184, 188, 193, 202									
	55 x 60 x 35	4 nf	PBT (Pocan)	26.5...31.6	IP 67	–	100	2	AC2310

Type	Dimensions [mm]	Sensing range [mm]	Material	U _b [V]	Protection	f AC / DC [Hz]	I _{load} AC / DC [mA]	Drawing no.	Order no.
------	--------------------	--------------------------	----------	-----------------------	------------	----------------------	--------------------------------------	----------------	--------------

M12 connector · AS-i · Wiring diagram no. 1 · Connector groups 10, 12, 13, 19, 21, 22, 23, 24, 148, 152, 153, 155, 184, 186, 188, 192, 193, 194, 202, 205



55 x 60 x 35 4 nf PBT (Pocan) 26.5...31.6 IP 67 - - 3 AC2315

M12 connector · Output function transistor PNP · AS-i · Wiring diagram no. 1 · Connector groups 8, 10, 19, 21, 23, 25, 44, 148, 149, 153, 159, 160, 184, 188, 193, 202



55 x 60 x 35 4 nf PBT (Pocan) 26.5...31.6 IP 67 - 100 2 AC2316

M12 connector · Output function transistor PNP · 2 inputs / 2 outputs · Connector groups 8, 10, 19, 21, 23, 25, 44, 148, 149, 153, 159, 160, 184, 188, 193, 202



55 x 60 x 35 4 nf PBT (Pocan) 26.5...31.6 IP 67 - - 2 AC2317

f = flush / nf = non flush / qf = quasi-flush

Wiring diagrams

1

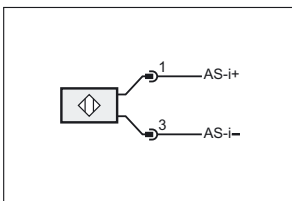

Scale drawings / drawing no. – CAD download: www.ifm.com

1

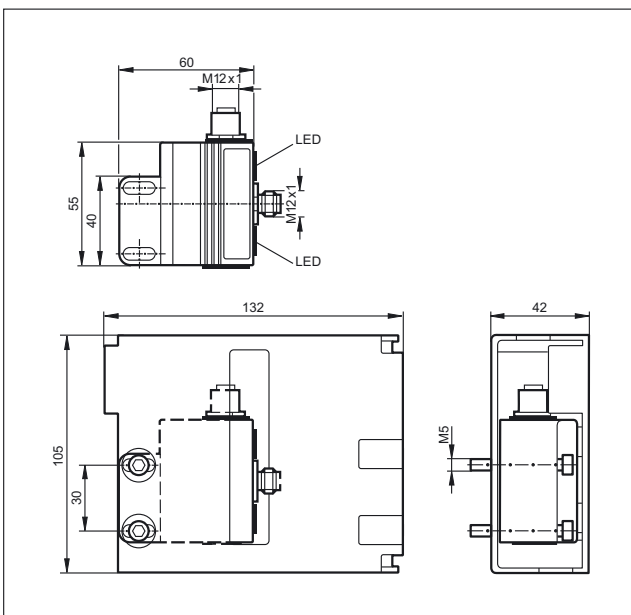

2

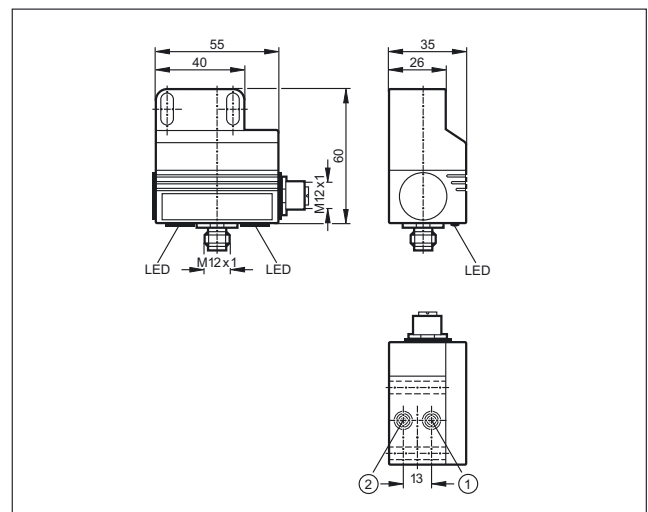

1: sensor 1, 2: sensor 2



Scale drawings / drawing no. – CAD download: www.ifm.com

3

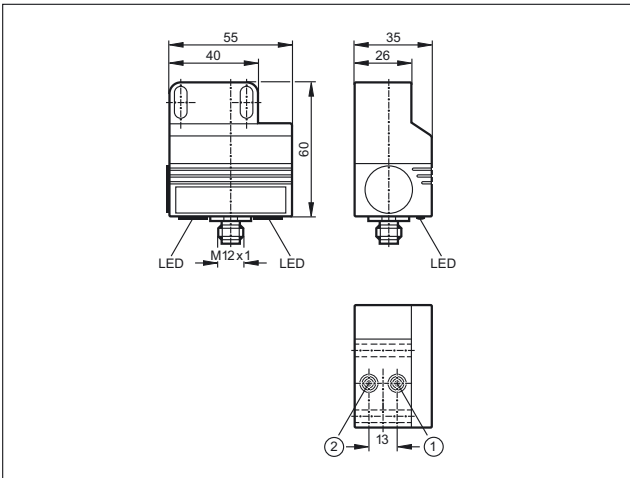

1: sensor 1, 2: sensor 2





Industrial communication







AS-Interface expansion

There are different ways to extend the AS-i cable. The specified one hundred metres can be extended up to 1000 metres in extreme cases.

System overview	Page
AS-i repeaters	642
Scale drawings / drawing no. – CAD download: www.ifm.com	642 - 643

AS-i repeaters

Type	Description	Draw- ing no.	Order no.
	AS-i repeater · Extension of the AS-i network by another 100 m · One additional AS-i power supply necessary · Combicon connection · PC GF20	1	AC3225
	Passive AS-i bus termination · Extension of the cable to a maximum of 200 m without additional repeater · Improvement of the signal quality · Monitoring of the supply voltage by means of LEDs	2	AC1147
	eASI-Tester · Local diagnosis of the AS-i network · Creation of test reports for AS-i networks · User-friendly diagnosis and evaluation via the connected PC	3	AC1145
	AS-i tuner diagnostic module · Extension of the cable to a maximum of 200 m without additional repeater · Monitoring of the message quality · Display of critical states by "traffic light" LEDs · PBT	4	AC1146

Scale drawings / drawing no. – CAD download: www.ifm.com

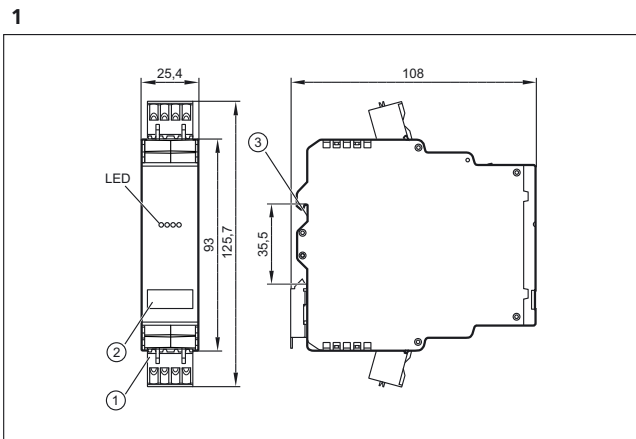

1: Plug with cage clamp connection, 2: label, 3: Mounting on DIN rail

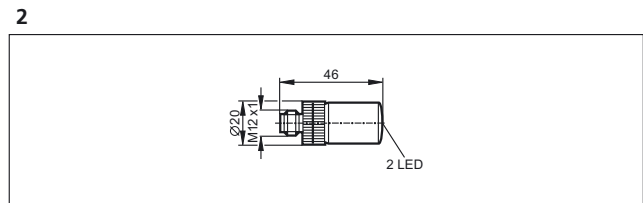

Scale drawings / drawing no. – CAD download: www.ifm.com

3

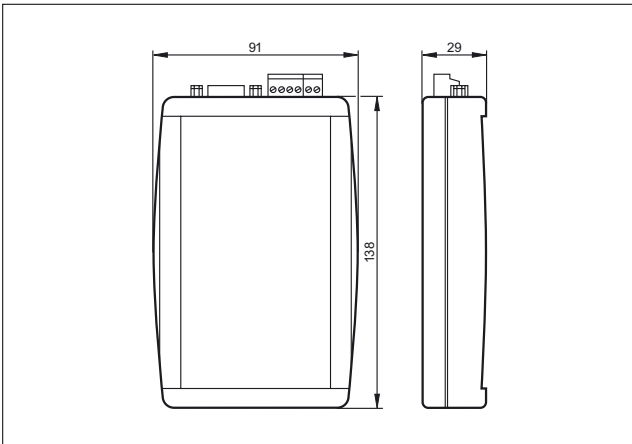

4

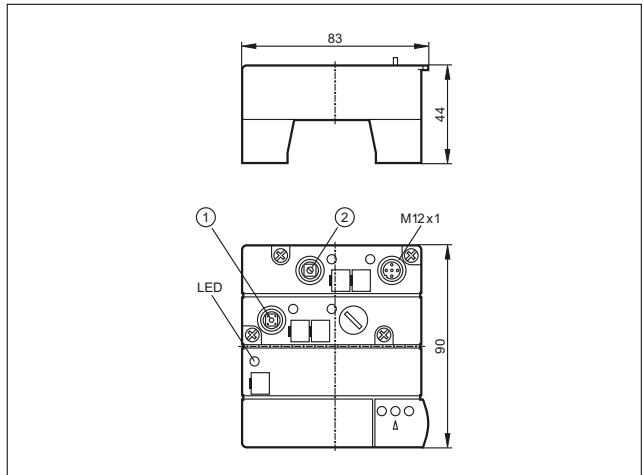

1: tune button, 2: mode selector



Industrial communication







AS-Interface Safety at Work

The sophisticated AS-i technology and the extended diagnostic possibilities provide high reliability and machine uptime.

"Safety at Work" is the extension of the AS-interface by safety-related components. Safety components up to the highest control category 4 to EN 954-1, SIL 3 to IEC 61508 and EN ISO 13849 - 1 / PL e can be connected to AS-i.

System overview	Page
Safety at Work	644 - 646
Accessories Safety at Work	646 - 647
AS-i manuals	647
Scale drawings / drawing no. – CAD download: www.ifm.com	647 - 650



Safety at Work

Type	Description	Draw- ing no.	Order no.
	AS-i safety monitor · Basic version · 1-channel · Configuration and setup by configuration software ASIMON · Screw terminal · polyamide black · Complies with the requirements: ISO 13849-1: PL e · IEC 61508: SIL 3	1	AC001S
	AS-i safety monitor · Basic version · 2-channel · Configuration and setup by configuration software ASIMON · Screw terminal · polyamide black · Complies with the requirements: ISO 13849-1: PL e · IEC 61508: SIL 3	1	AC002S
	AS-i safety monitor · Extended functionality · 1-channel · Configuration and setup by configuration software ASIMON · Screw terminal · polyamide black · Complies with the requirements: ISO 13849-1: PL e · IEC 61508: SIL 3	1	AC003S
	AS-i safety monitor · Extended functionality · 2-channel · Configuration and setup by configuration software ASIMON · Screw terminal · polyamide black · Complies with the requirements: ISO 13849-1: PL e · IEC 61508: SIL 3	1	AC004S
	AS-i safety monitor · Extended functionality and integrated safe slave for triggering a safe AS-i output · 2-channel · Configuration and setup by configuration software ASIMON V3.0 · Screw terminal · polyamide black · Complies with the requirements: ISO 13849-1: category 4 · ISO 13849-1: PL e · IEC 61508: SIL 3	2	AC032S
	AS-i safety monitor · 2 safe semi-conductor outputs · SIL 3 to EN 62061, IEC 61508 / SIL 3 and EN ISO 13849 - 1 / PL e · Chip card to save the configuration data · Configuration and setup by configuration software ASIMON V3 G2 · USB 2.0 interface · Chip card and Combicon screw terminals supplied with the device · Screw terminal	3	AC041S
	Safe active AS-i module · Performance Level e to EN ISO 13849-1 et IEC 61508 / SIL 3 for the connection of mechanical contacts · Combicon connection · PA · Complies with the requirements: ISO 13849-1: category 4 · ISO 13849-1: PL e · IEC 61508: SIL 3	4	AC009S
	Safe active AS-i output module · SIL 3 to EN 62061, IEC 61508 / SIL 3 and EN ISO 13849 - 1 / PL e · for the safe triggering of actuators · Combicon connection · PA · Complies with the requirements: ISO 13849-1: PL e · IEC 61508: SIL 3	5	AC030S
	AS-i Safety at Work · Safe AS-i input module 2SI - 2LO · Addressing socket · Three orientations of the flat cable are possible · Sockets M12 x 1 · PA / Piercing contacts: CuSn6 surface nickel and tin-plated · Complies with the requirements: ISO 13849-1: category 4 · ISO 13849-1: PL e · IEC 62061: SILcl 3	6	AC505S











Type	Description	Draw- ing no.	Order no.
	AS-i Safety at Work · Safe AS-i input module 4SI / 2DO T / 2LO · Addressing socket · Three orientations of the flat cable are possible · Sockets M12 x 1 · PA / Piercing contacts: CuSn6 surface nickel and tin-plated · Complies with the requirements: ISO 13849-1: category 3 · ISO 13849-1: PL d · IEC 62061: SILcl 2	6	AC506S
	AS-i Safety at Work · Addressing socket · Three orientations of the flat cable are possible · Sockets M12 x 1 · PA / Piercing contacts: CuSn6 surface nickel and tin-plated · Complies with the requirements: ISO 13849-1: category 4 · ISO 13849-1: PL e · IEC 61508: SIL 3 · IEC 62061: SILcl 3	6	AC507S
	AS-i Safety at Work · Sockets M12 x 1 · PA / Piercing contacts: CuSn6 surface nickel and tin-plated · Complies with the requirements: ISO 13849-1: category 3 · ISO 13849-1: PL d · IEC 62061: SILcl 2	6	AC509S
	Illuminated E-STOP · front mounting · reset by turning · 2 NC contacts / 1 red LED · fool-proof E-STOP to EN ISO 13850	7	E7007S
	Illuminated E-STOP with integrated AS-i connection · fool-proof E-STOP to EN ISO 13850 · Pull to reset · AS-i interface via AS-i flat cable IP 67 · PC GF20 · Complies with the requirements: ISO 13849-1: category 4 · ISO 13849-1: PL e · IEC 61508: SIL 3	8	AC010S
	Key-release E-STOP with integrated AS-i connection · Connector M12 x 1 · AS-i interface via AS-i flat cable IP 67 · fool-proof E-STOP to EN ISO 13850 · Reset by key operation · PC GF20 · Complies with the requirements: ISO 13849-1: category 4 · ISO 13849-1: PL e · IEC 61508: SIL 3	9	AC011S
	safe AS-i e-stop operating unit with integrated AS-i connection · AS-i interface via M12 x 1 connector · fool-proof E-STOP to EN ISO 13850 · Pull to reset · interchangeable button inserts · Complies with the requirements: ISO 13849-1: category 4 · ISO 13849-1: PL e · IEC 61508: SIL 3	10	AC012S
	AS-i safety PCB · Connection of mechanical contact and LED components · Certification to ISO 13849-1: PL e and IEC 61508 / SIL 3 · Complies with the requirements: · IEC 61508: SIL 3	11	AC015S
	AS-i Profinet gateway with safe preprocessing · Ethernet configuration interface with dynamic web interface for configuration and diagnosis including remote maintenance · Profinet RT device class B · LCD colour display · Integrated safety and non safety PLC · Configuration and setup by CODESYS V3 configuration software · aluminium powder-coated / steel sheet galvanised / Makrolon · Complies with the requirements: ISO 13849-1: category 4 · ISO 13849-1: PL e · IEC 61508: SIL 3	12	AC402S
	AS-i Profibus gateway · Ethernet configuration interface with dynamic web interface for configuration and diagnosis including remote maintenance · Profibus DP (DPV0 + DPV1) · LCD colour display · Configuration and setup by CODESYS V3 configuration software · aluminium powder-coated / steel sheet galvanised / Makrolon · Complies with the requirements: ISO 13849-1: category 4 · ISO 13849-1: PL e · IEC 61508: SIL 3	13	AC412S
	AS-i EtherNet/IP gateway with safe preprocessing · Ethernet configuration interface with dynamic web interface for configuration and diagnosis including remote maintenance · LCD colour display · Integrated safety and non safety PLC · Configuration and setup by CODESYS V3 configuration software · aluminium powder-coated / steel sheet galvanised / Makrolon · Complies with the requirements: ISO 13849-1: category 4 · ISO 13849-1: PL e · IEC 61508: SIL 3	12	AC422S
	Fail-safe inductive sensor · M12 connector, Gold-plated contacts · PPE / diecast zinc · Complies with the requirements: ISO 13849-1: category 4 · ISO 13849-1: PL e · IEC 61508: SIL 3	14	GM504S
	Fail-safe inductive sensor · M12 connector, Gold-plated contacts · PPE / diecast zinc · Complies with the requirements: ISO 13849-1: category 4 · ISO 13849-1: PL e · IEC 61508: SIL 3	14	GM505S
	Fail-safe inductive sensor · M18 x 1 · M12 connector, Gold-plated contacts · high-grade stainless steel / PBT · Complies with the requirements: ISO 13849-1: category 4 · ISO 13849-1: PL e · IEC 61508: SIL 3	15	GG505S
	Fail-safe inductive sensor · M30 x 1.5 · M12 connector, Gold-plated contacts · PEEK / high-grade stainless steel / O-ring: EPDM · Complies with the requirements: ISO 13849-1: category 4 · ISO 13849-1: PL e · IEC 61508: SIL 3	16	GI505S
	Safety switch with guard locking · Normally closed principle · Rotatable actuating head made of metal · Mechanical release on the front · Supply via AS-i / solenoid supply ext. from 24 V DC · M12 connector · thermoplastic reinforced glass-fibre	17	AC901S









Industrial communication



Type	Description	Draw- ing no.	Order no.
	Safety switch with guard locking · Normally open principle · Rotatable actuating head made of metal · Mechanical release on the front · Supply via AS-i / solenoid supply ext. from 24 V DC · M12 connector · thermoplastic reinforced glass-fibre	17	AC902S
	Safety switch with guard locking · Normally closed principle · Rotatable actuating head made of metal · Mechanical release on the front · Supply via AS-i / solenoid supply from AS-i · M12 connector · thermoplastic reinforced glass-fibre	18	AC903S
	Safety switch with guard locking · Normally open principle · Rotatable actuating head made of metal · Mechanical release on the front · Supply via AS-i / solenoid supply from AS-i · M12 connector · thermoplastic reinforced glass-fibre	18	AC904S

Accessories Safety at Work

Type	Description	Order no.
	AS-i Safety at Work · Programming software for AS-i safety monitor AC001S / AC002S / AC003S / AC004S / AC032S · Version 3.0 · Configuration, set-up and diagnostics of the AS-i safety monitor	E7040S
	Software ASIMON V3 G2 · Configuration, set-up and diagnostics of the AS-i safety monitor · AC041S	E7050S
	USB interface cable for the connection of the safety monitor AC041S to the PC · cable length 1.8 m · 1.8 m	E7051S
	Chip card to save the configuration data of the AS-i safety monitor AC041S · 256 K	E7052S
	Safe contact expander without delay · 2 independent channels · 4 contact blocks (NO) per channel · 1 feedback circuit (NC) per channel · Mounting on DIN rail · Screw terminal	E7053S
	Connection cable PC / AS-i safety monitor · Parameter setting cable PC / AS-i safety monitor · Western connector RJ 45 8 poles / D-Sub socket 9 poles · 2.5 m	E7001S
	Connection cable AS-i safety monitor / AS-i safety monitor · Download cable AS-i safety monitor / AS-i safety monitor · Western connector RJ 45 8 poles · 0.3 m	E7002S
	EMERGENCY STOP label IP66 4 languages DE, UK, FR, IT · EMERGENCY STOP label 4 languages for a safe illuminated EMERGENCY STOP button with integrated AS-i interface AC010S / AC011S / AC012S · 50 x 50 mm	E7003S
	EMERGENCY STOP protective collar · EMERGENCY STOP protective collar for safe E-STOP AC010S / AC011S / AC012S · Housing materials: PC GF20 RAL 1004	E7004S
	bridging plug for safety modules · Housing materials: PUR	E7005S

Type	Description	Order no.
	bridging plug for safety modules · Housing materials: PUR	E7008S
	Bulkhead connector · straight · M20 - M12 · M12 connector · 0.07 m · Housing materials: polyamide	E7006S
	Bolt for safety guards · for heavy doors · For right or left hinged doors without escape release · No additional door handle required · screw mounting onto common aluminium profiles and machine panels · Housing materials: diecast aluminium yellow	E7901S
	Bolt for safety guards · for heavy doors · For right or left hinged doors without escape release · No additional door handle required · screw mounting onto common aluminium profiles and machine panels · Housing materials: glass-fibre reinforced plastic yellow	E7902S
	Actuator S standard straight · With rubber bush, overtravel 5 mm · Suitable for a maximum pull force of 2500 N for the door switches AC901S - AC904S	E7903S
	Actuator S standard angled · With rubber bush, overtravel 5 mm · Suitable for a maximum pull force of 2500 N for the door switches AC901S - AC904S	E7904S
	Hinged actuator left / right · For left or right hinged doors, overtravel 5 mm	E7905S
	Hinged actuator top / bottom · For top and bottom hinged doors, overtravel 5 mm	E7906S

AS-i manuals

Type	Description	Order no.
	ecolog asi system · AS-Interface Manual (German)	AC0115
	ecolog asi system · AS-Interface Manual (English)	AC0116

Scale drawings / drawing no. – CAD download: www.ifm.com

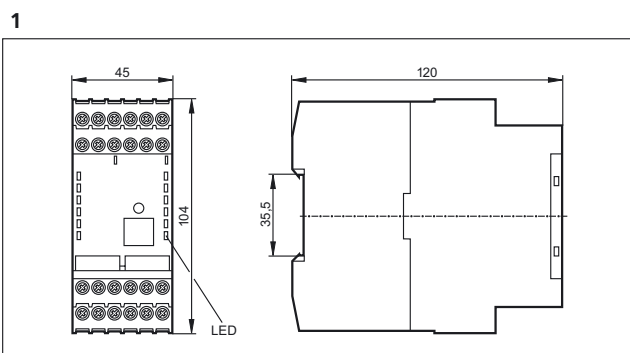



Scale drawings / drawing no. – CAD download: www.ifm.com

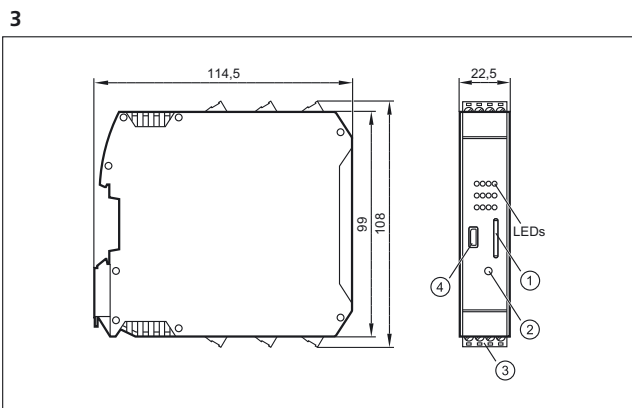
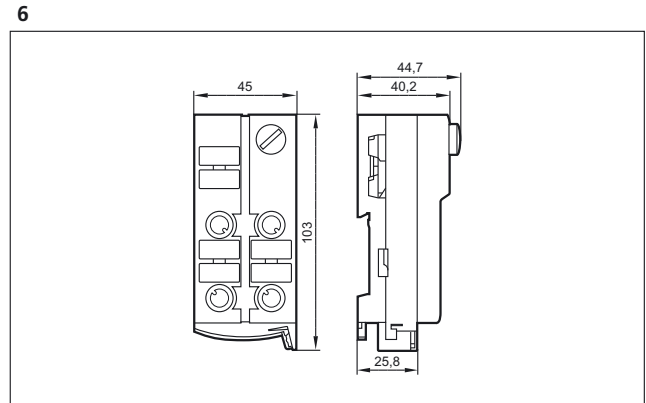
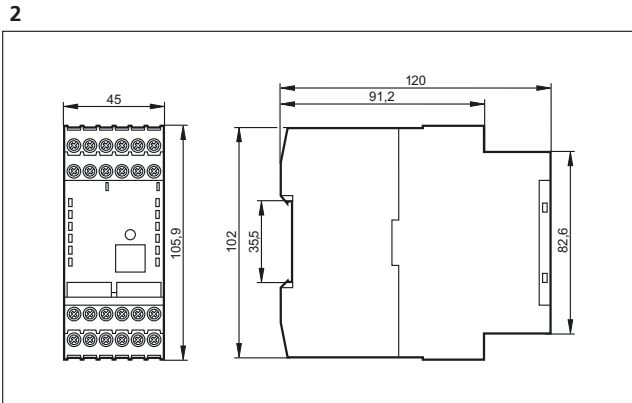

1: Chip card, 2: service button, 3: Combi-con connector with screw terminals, 4: Micro USB interface

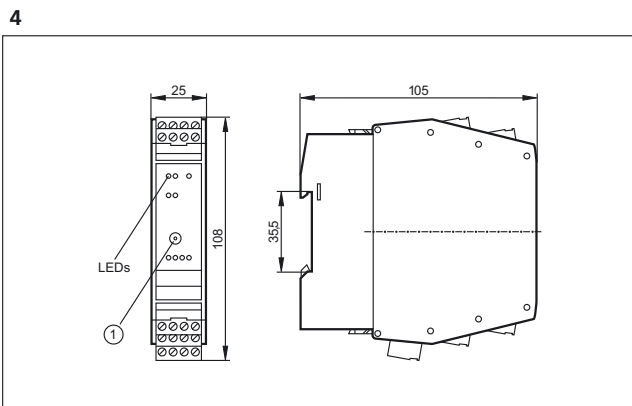
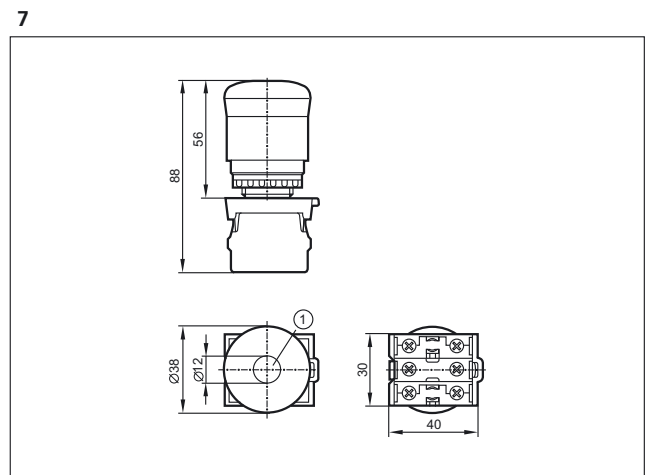

1: Addressing socket

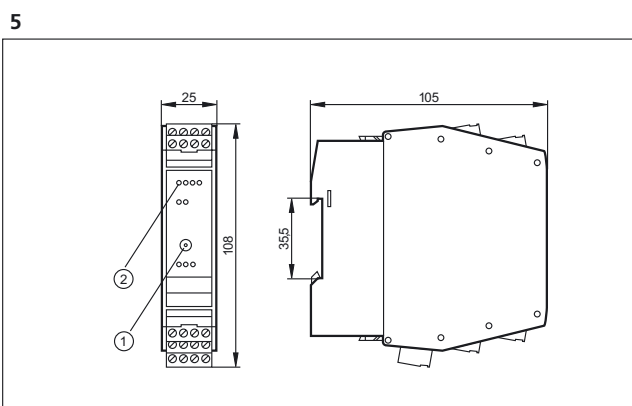
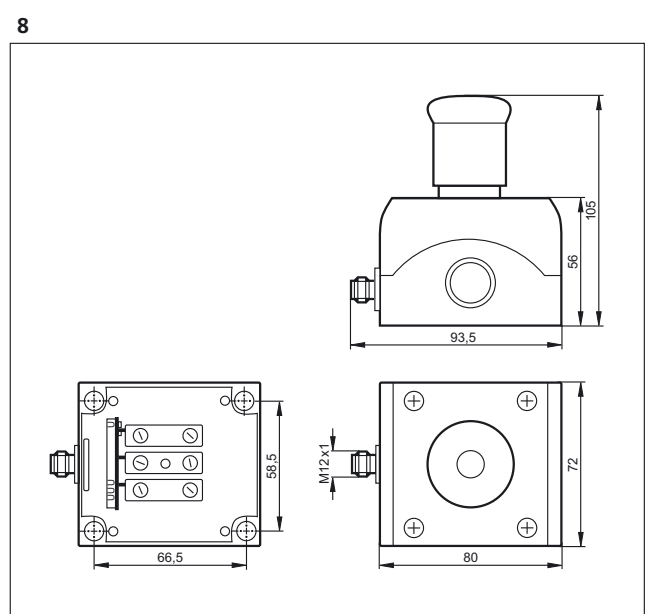

1: Addressing socket, 2: LED

Scale drawings / drawing no. – CAD download: www.ifm.com

9

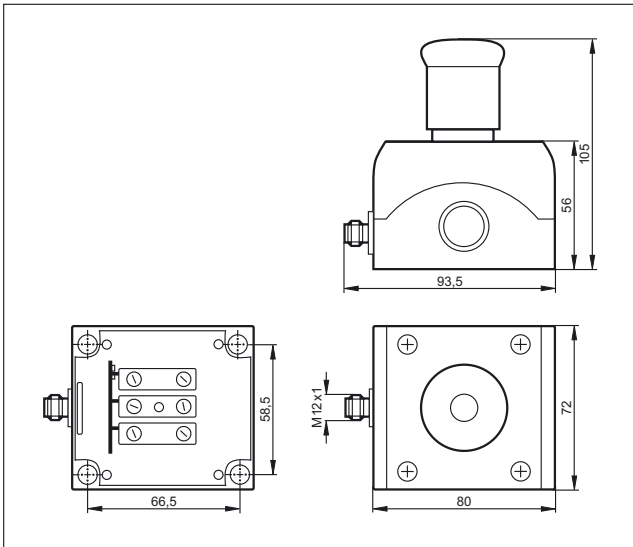

10

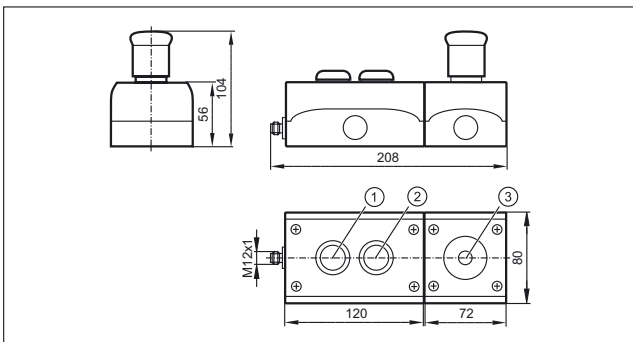

11

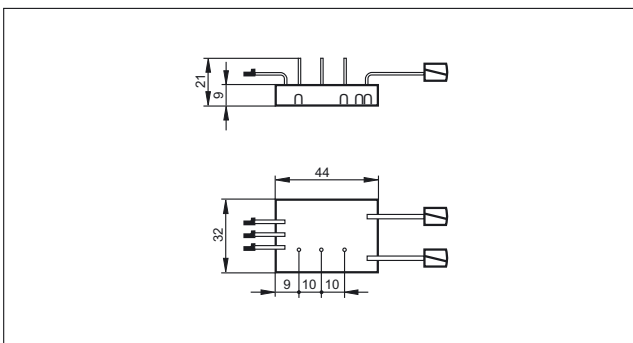

12

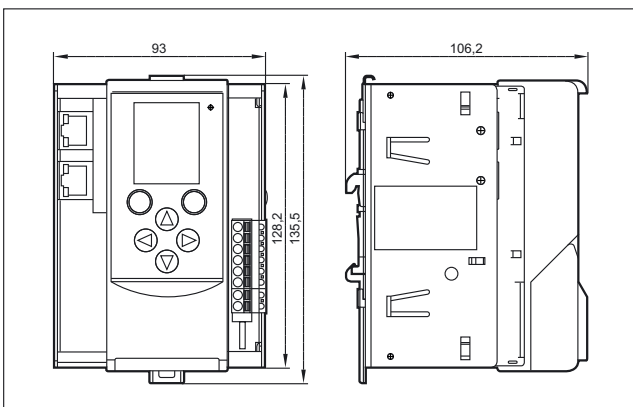

13

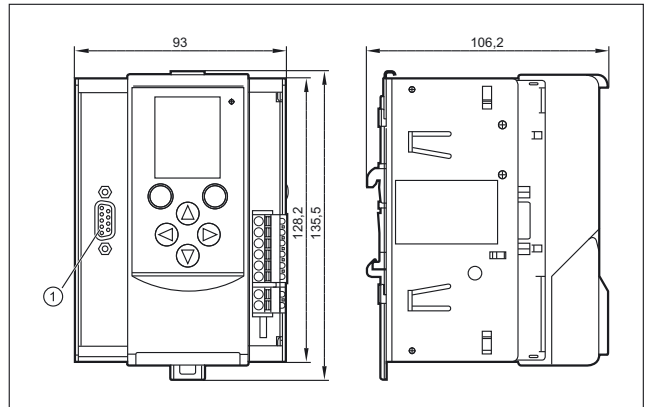

14

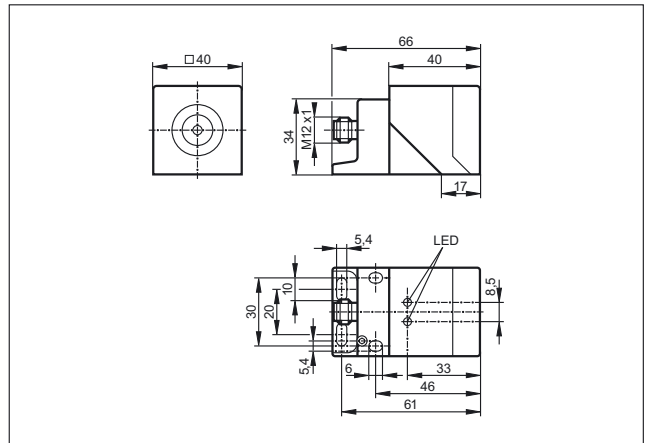

15

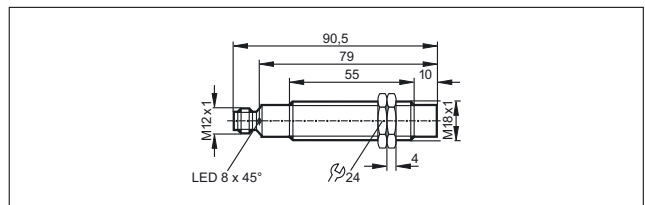

16

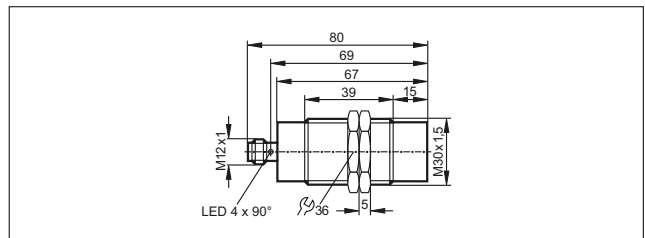



Scale drawings / drawing no. – CAD download: www.ifm.com

17

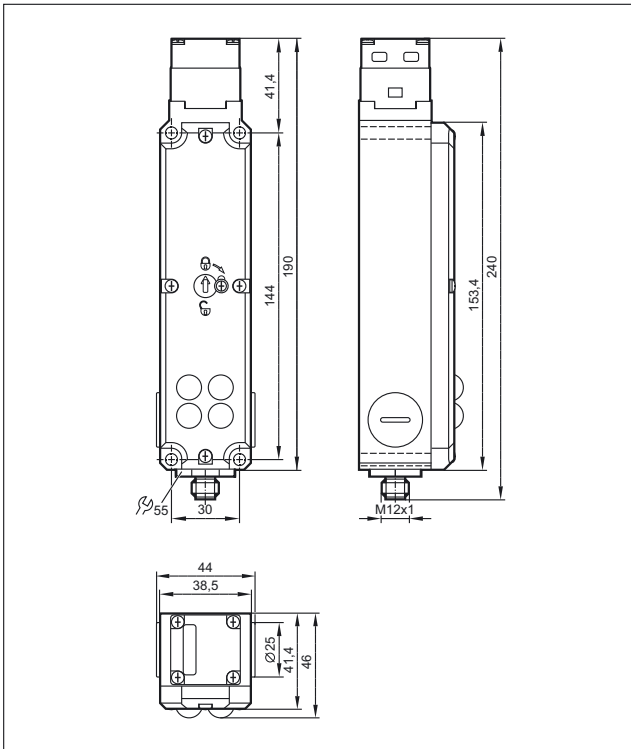

18

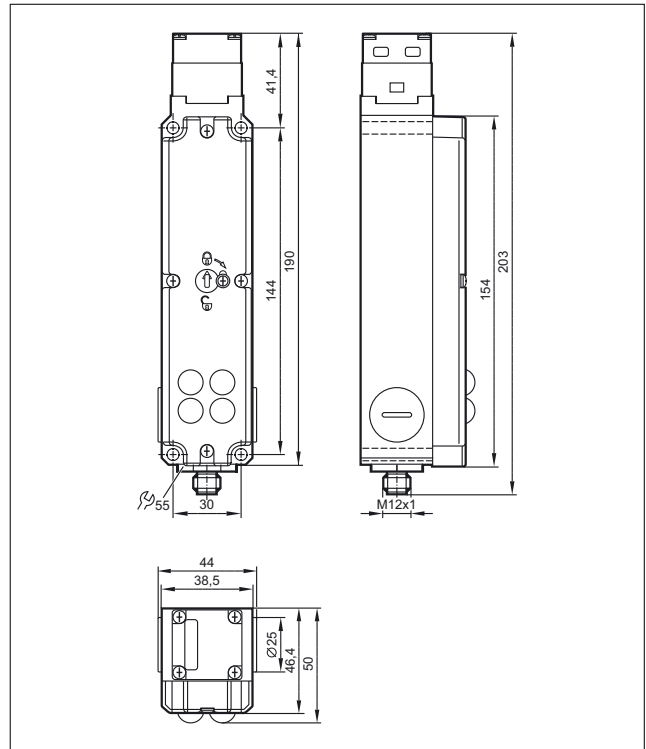





Industrial communication



IO-Link components

IO-Link is a manufacturer-independent point-to-point communication system used to connect sensors and actuators to an automation system.

An IO-Link system consists of an IO-Link master and several IO-Link devices.

The IO-Link master represents the interface to the controller or fieldbus level and communicates with the connected IO-Link devices.

IO-Link is capable of processing switching signals of binary sensors, process values of analogue sensors and their parameters in a purely digital form based on a 24 V signal. This eliminates measuring value errors associated with the transmission and conversion of analogue signals.

IO-Link can be used to transfer several process values or parameters of a device simultaneously via one unshielded standard cable. IO-Link is an internationally standardised fieldbus and controller independent interface.

System overview	Page
IO-Link components	652 - 653
Accessories and software	653 - 654
Scale drawings / drawing no. – CAD download: www.ifm.com	654 - 656

IO-Link components

Type	Inputs / outputs	Description	Drawing no.	Order no.
	max. 4 IO-Link ports / max. 8 digital inputs / max. 4 digital outputs	IO-Link master with Profinet interface · I/O modules for field applications · Suited for use in the food and beverage industry (use of cleaning agents under high pressure and at high temperatures) · M12 connector · housing: polyamide grey / socket: Stainless steel 303	1	AL1101
	max. 4 IO-Link ports / max. 8 digital inputs / max. 4 digital outputs	IO-Link master with EtherNet/IP interface · I/O modules for field applications · Suited for use in the food and beverage industry (use of cleaning agents under high pressure and at high temperatures) · M12 connector · housing: polyamide grey / socket: Stainless steel 303	1	AL1121
	max. 8 IO-Link ports / max. 16 digital inputs / max. 8 digital outputs	IO-Link master with Profinet interface · I/O modules for field applications · Suited for use in the food and beverage industry (use of cleaning agents under high pressure and at high temperatures) · M12 connector · housing: polyamide grey / socket: Stainless steel 303	2	AL1103
	max. 8 IO-Link ports / max. 16 digital inputs / max. 8 digital outputs	IO-Link master with EtherNet/IP interface · I/O modules for field applications · Suited for use in the food and beverage industry (use of cleaning agents under high pressure and at high temperatures) · M12 connector · housing: polyamide grey / socket: Stainless steel 303	2	AL1123
	6 x 2 outputs	Active CompactLine module (IO-Link device) · I/O modules for field applications · Suited for use in the food and beverage industry (use of cleaning agents under high pressure and at high temperatures) · Sockets M12 x 1 · housing: polyamide grey / socket: Stainless steel 303	3	AL2230
	max. 4 IO-Link ports / max. 8 digital inputs / max. 4 digital outputs	IO-Link master with Profinet interface · I/O modules for field applications · M12 connector · housing: polyamide / socket: Brass nickel-plated	1	AL1100
	max. 4 IO-Link ports / max. 8 digital inputs / max. 4 digital outputs	IO-Link master with EtherNet/IP interface · I/O modules for field applications · M12 connector · housing: polyamide / socket: Brass nickel-plated	1	AL1120
	max. 4 IO-Link ports / max. 8 digital inputs / max. 4 digital outputs	IO-Link master with Profinet interface · I/O modules for field applications · M12 connector · housing: polyamide / socket: Brass nickel-plated	4	AL1200
	max. 4 IO-Link ports / max. 8 digital inputs / max. 4 digital outputs	IO-Link master with EtherNet/IP interface · I/O modules for field applications · M12 connector · housing: polyamide / socket: Brass nickel-plated	4	AL1220







Type	Inputs / outputs	Description	Draw- ing no.	Order no.
	max. 8 IO-Link ports / max. 12 digital inputs / max. 8 digital outputs	IO-Link master with Profinet interface · I/O modules for field applications · M12 connector · housing: polyamide / socket: Brass nickel-plated	5	AL1202
	max. 8 IO-Link ports / max. 12 digital inputs / max. 8 digital outputs	IO-Link master with EtherNet/IP interface · I/O modules for field applications · M12 connector · housing: polyamide / socket: Brass nickel-plated	5	AL1222
	max. 8 IO-Link ports / max. 16 digital inputs / max. 8 digital outputs	IO-Link master with Profinet interface · I/O modules for field applications · M12 connector · housing: polyamide / socket: Brass nickel-plated	2	AL1102
	max. 8 IO-Link ports / max. 16 digital inputs / max. 8 digital outputs	IO-Link master with EtherNet/IP interface · I/O modules for field applications · M12 connector · housing: polyamide / socket: Brass nickel-plated	2	AL1122
	4 x 2 inputs	Active CompactLine module (IO-Link device) · 4 way · Supply via IO-Link M12 connector · Digital inputs · Sockets M12 x 1 · PA / socket: Brass nickel-plated / O-Ring : Viton	6	AL2400
	6 x 2 outputs	Active CompactLine module (IO-Link device) · I/O modules for field applications · Sockets M12 x 1 · housing: polyamide / socket: Brass nickel-plated	3	AL2330
	8 x 2 inputs	Active CompactLine module (IO-Link device) · 8 way · Supply via IO-Link M12 connector · Digital inputs · Sockets M12 x 1 · PA / socket: Brass nickel-plated / O-Ring : Viton	7	AL2401
	max. 8 IO-Link ports / max. 12 digital inputs / max. 8 digital outputs	IO-Link master with Profinet interface · I/O modules for field applications · housing: PA / socket: Brass nickel-plated	8	AL1000
	max. 8 IO-Link ports / max. 12 digital inputs / max. 8 digital outputs	IO-Link master with Profibus interface · I/O modules for field applications · Sockets M12 x 1 · housing: PA / socket: Brass nickel-plated	9	AL1010
	max. 8 IO-Link ports / max. 12 digital inputs / max. 8 digital outputs	IO-Link master with EtherNet/IP interface · I/O modules for field applications · Sockets M12 x 1 · housing: PA / socket: Brass nickel-plated	8	AL1020
	max. 8 IO-Link ports / max. 12 digital inputs / max. 8 digital outputs	IO-Link master with EtherCat interface · I/O modules for field applications · Sockets M12 x 1 · housing: PA / socket: Brass nickel-plated	8	AL1030
	8 IO-Link ports / 10 digital inputs / 2 digital inputs or outputs	IO-Link master with Profinet interface · I/O modules for use in the control cabinet · IO-Link master 8 ports A and B variable · LineRecorder Agent embedded · 2 Ethernet ports with integrated switch · Additional binary inputs and outputs can be configured · Housing for DIN rail mounting · Screw terminal · housing: polyamide	10	AY1000
	8 IO-Link ports / 10 digital inputs / 2 digital inputs or outputs	IO-Link master with EtherNet/IP interface · I/O modules for use in the control cabinet · IO-Link master 8 ports A and B variable · LineRecorder Agent embedded · 2 Ethernet ports with integrated switch · Additional binary inputs and outputs can be configured · Housing for DIN rail mounting · Screw terminal · housing: polyamide	10	AY1020

Accessories and software

Type	Description	Order no.
	App for parameter setting and set-up of IO-Link sensors · Single user licence included (article no. E71400) · Version 1.1.0 · Data carrier: USB stick	AP3002



Industrial communication

Type	Description	Order no.
	App for parameter setting and set-up of up to 5 O2I multicode readers · Single user licence included (article no. E71400) · Version 1.0.2 · Data carrier: USB stick	AP3022
	App for parameter setting and set-up of the 3D camera O3D2nn · Single user licence included (article no. E71400) · Version 1.0.0 · Data carrier: USB stick	AP3032
	App for parameter setting and set-up of the RFID read/write head · Single user licence included (article no. E71400) · Version 1.0.0 · Data carrier: USB stick	AP3042
	App for collecting and saving process data from AS-i IO-Link modules (AC5225) and analogue AS-i input slaves · Single user licence included (article no. E71400) · Version 1.0.1 · Data carrier: USB stick	AP3052
	App for the management of 999 AS-i configurations without special hardware · Single user licence included (article no. E71400) · Version 1.0.0 · Data carrier: USB stick	AP3062
	Protective cap · M12 · for M12 socket · IO-Link master · IO-Link device · Housing materials: end cap: Stainless steel 303 / sealing: EPDM	E12542

Scale drawings / drawing no. – CAD download: www.ifm.com

1

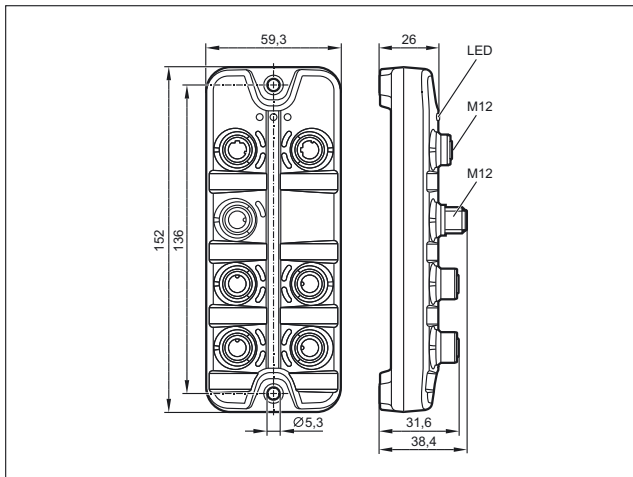

2

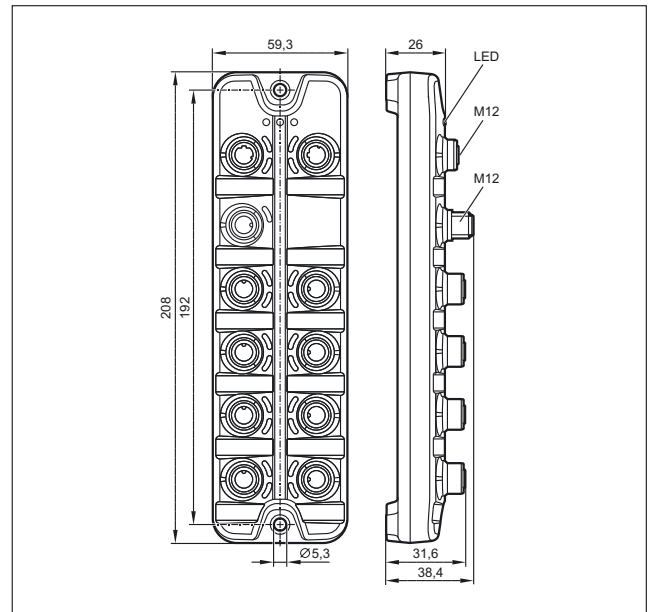

Scale drawings / drawing no. – CAD download: www.ifm.com

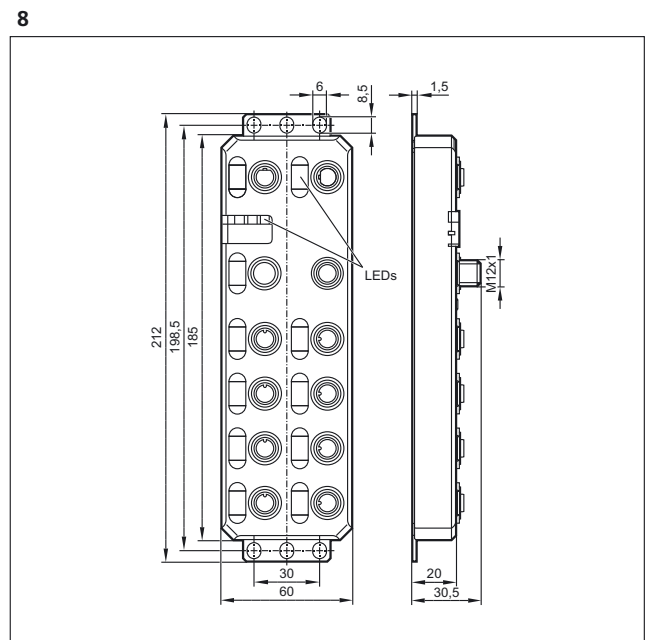
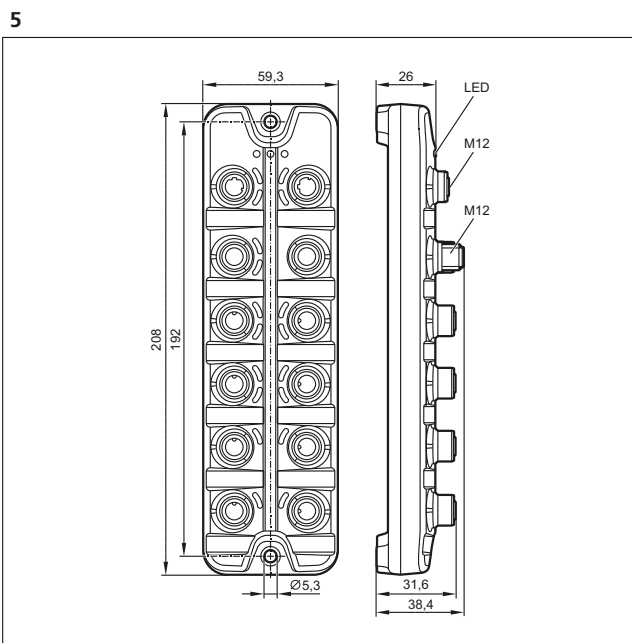
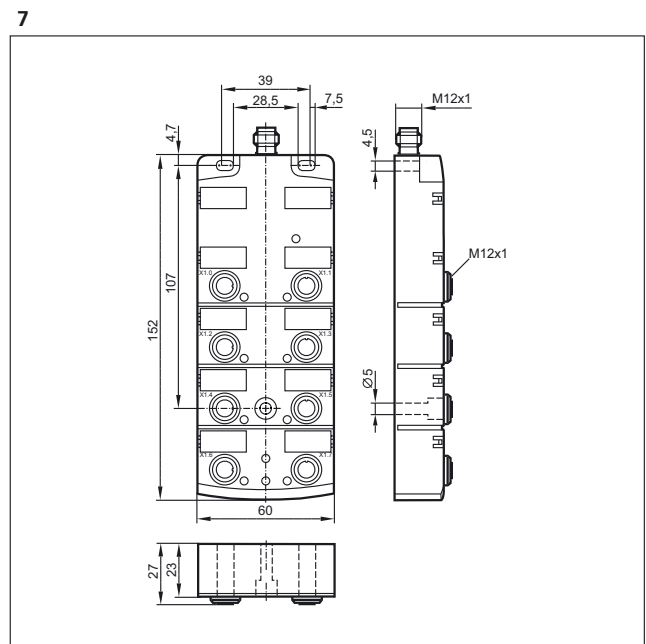
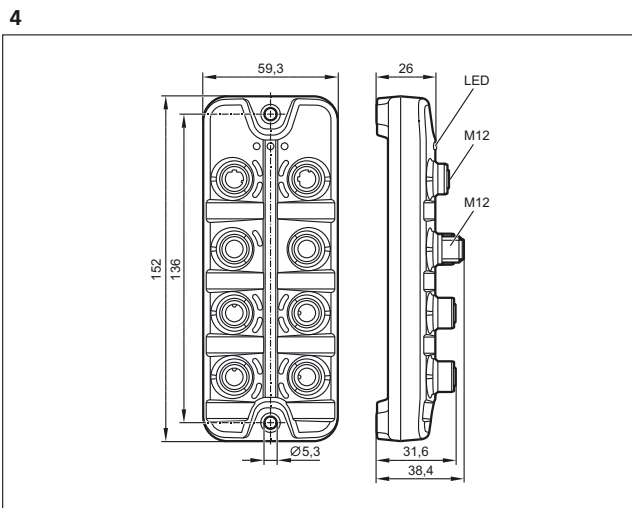
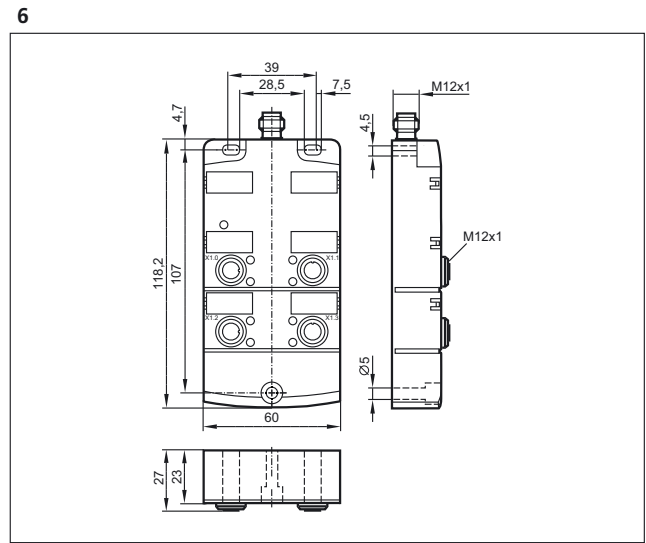
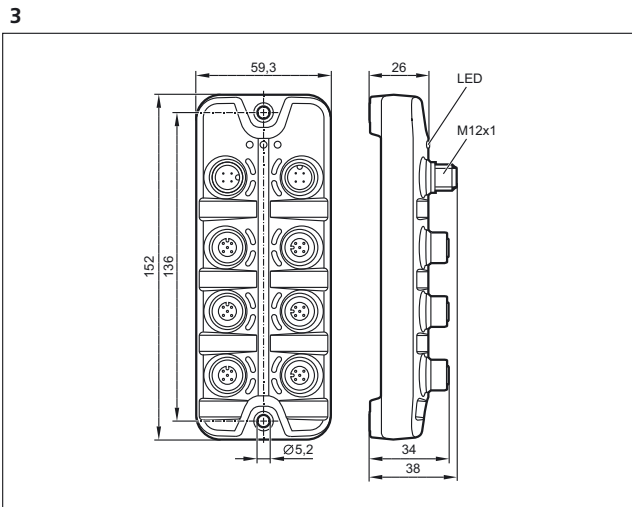



Scale drawings / drawing no. – CAD download: www.ifm.com

9

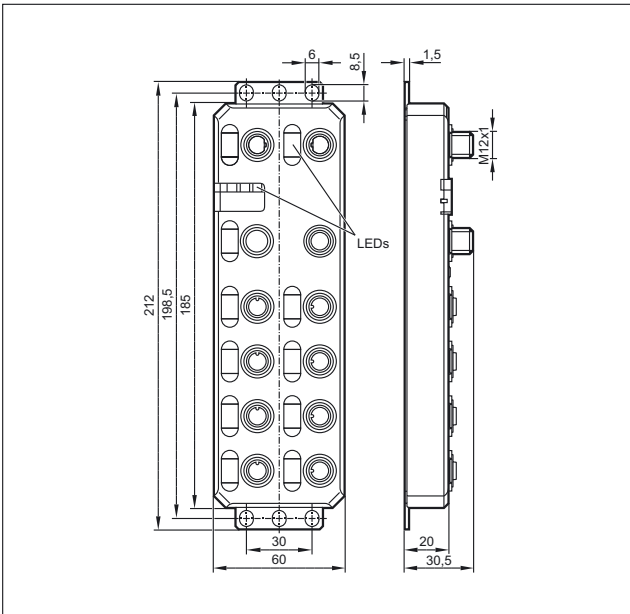

10

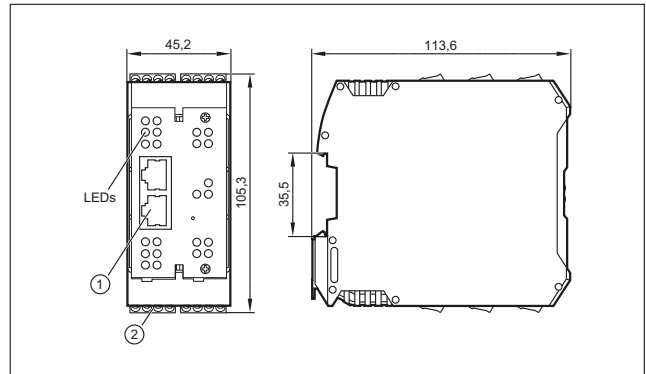

1: Ethernet interface, 2: screw terminals





Multicode readers and RFID for clear identification



Multicode readers

ifm multicode readers handle not only the ECC200 Data Matrix code, but also many more 2D and 1D codes. Code reading is not dependent on the orientation of the code to the sensor. The industrially compatible mounting and wiring technology as well as the standardised process interfaces enable easy and quick integration into the industrial control system.

RF identification systems

ifm offers different RFID systems using different frequencies, ranges, interfaces and data volumes.

LF 125 kHz system with AS-Interface

ifm offers the first RFID system for AS-Interface worldwide. Up to 31 read/write heads can be connected to one AS-i master. Antenna, electronics and AS-i interface are integrated in a compact housing.

LF 125 kHz / HF 13.56 MHz system with different fieldbus interfaces





The RFID evaluation unit DTE10x with integrated fieldbus interfaces and web server is widely used in production to mark tools, for quality assurance, to monitor production steps, in conveying and in automation technology.

RFID compact unit suitable for mobile use

The robust RFID compact unit with CANopen interface has been developed for identification tasks in agricultural machines, municipal vehicles and construction machines.

UHF system with Ethernet

The ultra low and low range antennas achieve selectivities of a few centimetres. The mid-range antenna is chosen for applications in the near / far field with reading ranges of up to 2 m. The wide range antenna attains reading ranges of up to 10 m.

	RFID 125 kHz	660 - 665
	RFID 13.56 MHz	666 - 673
	RFID UHF	674 - 677
	1D/2D code readers	678 - 683





Identification systems





RFID 125 kHz



RFID systems based on 125 kHz for production and conveying technology, identification of workpiece carriers and products.

- System DTS 125 with AS-Interface
- System DTE 100 with Profibus DP
- System DTE 101 with Profinet
- System DTE 102 with Ethernet/IP











System overview	Page
RFID system 125 kHz with AS-Interface	660 - 661
ID tags 125 kHz for system DTS 125	661 - 662
Handheld readers for system DTS 125	662
Fixing components	662
DTE 100 RFID system with Profibus DP	662
DTE 101 RFID system with ProfiNet	663
DTE102 RFID system with EtherNet/IP	663
DTE103 RFID system with EtherCAT	663
DTE104 RFID system with Ethernet TCP/IP	663
RFID antennas 125 kHz for system DTE100, DTE101, DTE102, DTE104	663
RFID tags 125 kHz for antenna ANT512	664
Accessories DTE100	664
Connection technology	664
Scale drawings / drawing no. – CAD download: www.ifm.com	665

RFID system 125 kHz with AS-Interface

Type	Dimensions [mm]	Travel speed read / write [m/s]	Process interface	Drawing no.	Order no.
M12 connector · Connector groups 8, 10, 19, 21, 23, 25, 148, 149, 153, 184, 188, 193, 202					
	55 x 24 x 41	read: ≤ 0.5 (distance to the ID tag 15 mm) write: only static	AS-i	1	DTA100
	55 x 24 x 41	read: ≤ 0.5 (distance to the ID tag 15 mm)	AS-i	1	DTA101
	40 x 40 x 54	read: ≤ 0.5 (distance to the ID tag 30 mm) write: only static	AS-i	2	DTA200

Type	Dimensions [mm]	Travel speed read / write [m/s]	Process interface	Draw- ing no.	Order no.
M12 connector · Connector groups 8, 10, 19, 21, 23, 25, 148, 149, 153, 184, 188, 193, 202					
	40 x 40 x 54	read: ≤ 0.5 (distance to the ID tag 30 mm)	AS-i	2	DTA201
	92 x 80 x 40	read: ≤ 0.5 (distance to the ID tag 40 mm) write: only static	AS-i	3	DTA300
	92 x 80 x 40	read: ≤ 0.5 (distance to the ID tag 40 mm)	AS-i	3	DTA301

ID tags 125 kHz for system DTS 125

Type	Description	Order no.
	ID tag · ID-TAG/M5x16.5/01 · M5 x 16.5 mm · Screw mounting · Housing materials: PA black (RAL 9005)	E80301
	ID tag · ID-TAG/M18x1/01 · M18 x 1 · Screw mounting · in metal · Housing materials: threaded sleeve: PBT orange	E80311
	ID tag · ID-TAG/D12x2/01 · Ø 12 x 2 mm · Housing materials: PPS black	E80312
	ID tag · ID-TAG/D20x2.15/01 · Ø 20 x 2.15 mm · Housing materials: polycarbonate black	E80317
	ID tag · ID-TAG/D30x2.15/01 · Ø 30 x 2.15 mm · Housing materials: polycarbonate black	E80318
	ID tag · ID-TAG/D50x2.2/01 · Ø 50 x 2.2 mm · Housing materials: polycarbonate black	E80319
	ID tag · ID-TAG/D26x4/01 · Ø 26 x 4 mm · Housing materials: PA High Temperature	E80322
	ID tag · ID-TAG/M5x16.5/01 · M5 x 16.5 mm · Screw mounting · Housing materials: PA black (RAL 9005)	E80345
	ID tag · ID-TAG/ISO-Card/01 · 54 x 86 x 1 mm · Housing materials: PVC white	E80320
	ID tag · ID-TAG/TRIANGLE HOUSING/01 · with ID tag E80345 · Housing materials: PBT orange (RAL 2003) / PA black (RAL 9005)	E80346



Identification systems

Type	Description	Order no.
	ID tag · ID-TAG/TRIANGLE HOUSING/01 · with ID tag E80301 · Housing materials: PBT orange (RAL 2003) / PA black (RAL 9005)	E80302

Handheld readers for system DTS 125

Type	Description	Order no.
	RFID Handheld Reader USB · suitable for use in PCs or notebooks · 125 kHz · 1.8 m · Housing materials: PS	E80321

Fixing components

Type	Description	Order no.
	Angle bracket · Housing materials: stainless steel	E80304
	Mounting set · Clamp mounting · aluminium profile · for type OC · Housing materials: fixture: stainless steel 316Ti / 1.4571 / clamp: diecast zinc / Cube: diecast zinc	E20901
	Mounting bracket · with integrated snap-on rail · for type IDC · Housing materials: stainless steel	E10730
	Mounting set · Clamp mounting · aluminium profile · for type OC · Housing materials: fixture: stainless steel 316Ti / 1.4571 / clamp: diecast zinc / Cube: diecast zinc	E20901
	Dovetail clamp · for type DTS, O4, O5 · Housing materials: AlMgSi0.5	E21088

DTE 100 RFID system with Profibus DP

Type	Description	Draw- ing no.	Order no.
Type DTE1 · M12 connector			
	RFID evaluation unit · for up to 4 read/write heads type ANT41x/ANT51x · Housing materials: Upper part: PA Grivory GV-5H orange / Upper part: TPE / lower part: GD-AlSi12	4	DTE100

DTE 101 RFID system with ProfiNet

Type	Description	Draw- ing no.	Order no.
------	-------------	---------------------	--------------

Type DTE1 · M12 connector

	RFID evaluation unit · for up to 4 read/write heads type ANT41x/ANT51x · Housing materials: Upper part: PA Grivory GV-5H orange / Upper part: TPE / lower part: GD-ALSi12	5	DTE101
---	---	---	--------

DTE102 RFID system with EtherNet/IP

Type	Description	Draw- ing no.	Order no.
------	-------------	---------------------	--------------

Type DTE1 · M12 connector

	RFID evaluation unit · for up to 4 read/write heads type ANT41x/ANT51x · Housing materials: Upper part: PA Grivory GV-5H orange / Upper part: TPE / lower part: GD-ALSi12	5	DTE102
---	---	---	--------

DTE103 RFID system with EtherCAT

Type	Description	Draw- ing no.	Order no.
------	-------------	---------------------	--------------

Type DTE1 · M12 connector

	RFID evaluation unit · for up to 4 read/write heads type ANT41x/ANT51x · Housing materials: Upper part: PA Grivory GV-4H orange / Upper part: TPE / lower part: GD-ALSi12	5	DTE103
---	---	---	--------

DTE104 RFID system with Ethernet TCP/IP

Type	Description	Draw- ing no.	Order no.
------	-------------	---------------------	--------------

Type DTE1 · M12 connector

	RFID evaluation unit · for up to 4 read/write heads type ANT41x/ANT51x · Housing materials: Upper part: PA Grivory GV-5H orange / Upper part: TPE / lower part: GD-ALSi12	5	DTE104
---	---	---	--------

RFID antennas 125 kHz for system DTE100, DTE101, DTE102, DTE104

Type	Description	Draw- ing no.	Order no.
------	-------------	---------------------	--------------

	Read/write head · M12 connector · 5 positions of the sensing face selectable · Housing materials: housing: PA / Metal parts: stainless steel	2	ANT512
---	--	---	--------



Identification systems





RFID tags 125 kHz for antenna ANT512

Type	Description	Order no.
	ID tag · ID-TAG/30X2.5/05 - 256 bit · Ø 30 x 2.5 mm · Housing materials: PA 6 black	E80360
	ID tag · ID-TAG/30X2.5/05 - 2048 bit · Ø 30 x 2.5 mm · Housing materials: PA 6 black	E80361

Accessories DTE100

Type	Description	Order no.
	Terminating resistor plug · straight · Free from silicone · Free from halogen · Gold-plated contacts · Housing materials: PUR	E12315
	Jumper · straight / straight · Free from halogen · Gold-plated contacts · 10 m · Housing materials: PUR	E12317
	Cable plug · straight · Free from halogen · Gold-plated contacts · M12 connector · 10 m · Housing materials: PUR	E12319
	Socket · straight · Free from halogen · Gold-plated contacts · M12 connector · 10 m · Housing materials: PUR	E12321

Connection technology

Type	Description	Order no.
	Jumper · straight / straight · Ethernet · Cross-over patch cable · 2 m · Housing materials: PUR / PC	E11898
	Jumper · straight / straight · Ethernet · Cross-over patch cable · 2 m · Housing materials: TPU / PA	E12090
	Jumper · straight / straight · Ethernet · 10 m · Housing materials: PUR / PC	E12204
	Jumper · straight / straight · Ethernet · 20 m · Housing materials: PUR / PC	E12205

Scale drawings / drawing no. – CAD download: www.ifm.com

1

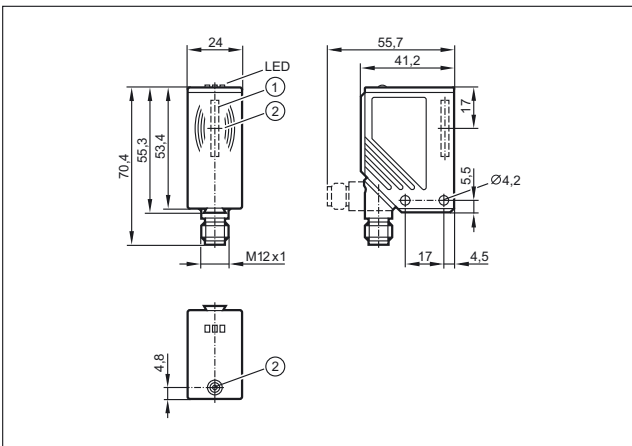

1: integrated antenna, 2: tag positioning mark (middle of the antenna)

2

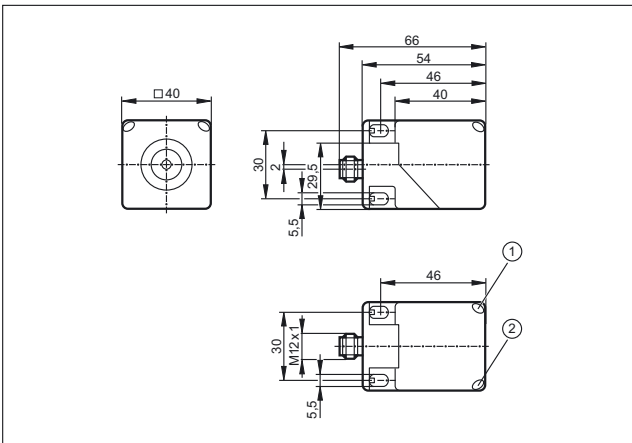

1: LED yellow, 2: LED green

3

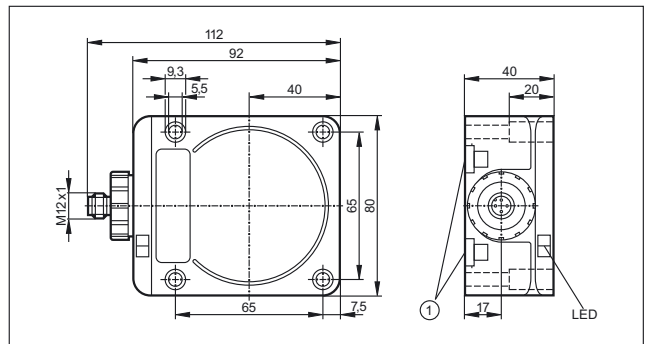

1: Mounting on DIN rail

4

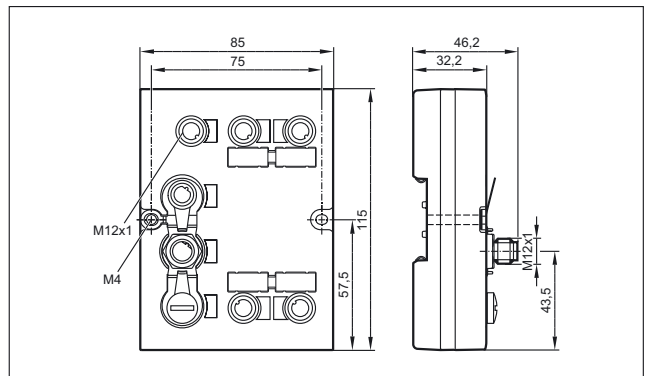

5

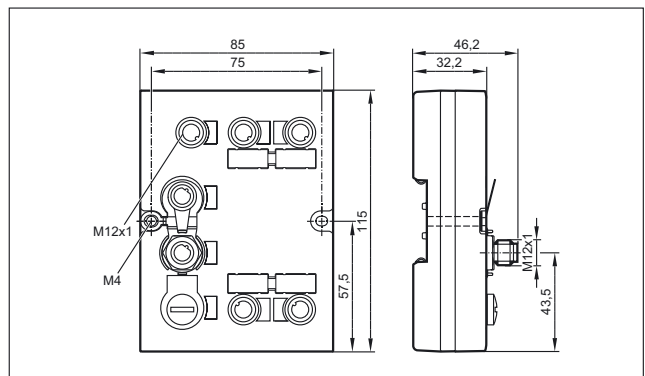



Identification systems



RFID 13.56 MHz

Flexible system for production, assembly and handling technology. Ensures fast data transmission and supports the ISO 15693 standard.

- DTE100 system with Profibus DP
- DTE101 system with Profinet
- DTE102 system with EtherNet/IP
- DTE104 system with EtherNetTCP/IP

System overview	Page
DTE 100 RFID system with Profibus DP	666
DTE 101 RFID system with ProfiNet	667
DTE102 RFID system with EtherNet/IP	667
DTE103 RFID system with EtherCAT	667
DTE104 RFID system with Ethernet TCP/IP	667
RFID antennas 13.56 MHz for system DTE100, DTE101, DTE102, DTE104	667 - 668
RFID systems DTM424, DTM425, DTM434, DTM435 for mobile machines	668 - 669
RFID tags 13.56 MHz for antennas ANT513, ANT410, ANT411, ANT430, ANT431, DTM424, DTM425, DTM434, DTM435	669 - 671
Accessories DTE100	671
Accessories DTM	671
Connection technology	672
Scale drawings / drawing no. – CAD download: www.ifm.com	672 - 673

DTE 100 RFID system with Profibus DP

Type	Description	Drawing no.	Order no.
Type DTE1 · M12 connector			
	RFID evaluation unit · for up to 4 read/write heads type ANT41x/ANT51x · Housing materials: Upper part: PA Grivory GV-5H orange / Upper part: TPE / lower part: GD-AlSi12	1	DTE100

DTE 101 RFID system with ProfiNet

Type	Description	Draw- ing no.	Order no.
------	-------------	---------------------	--------------

Type DTE1 · M12 connector

	RFID evaluation unit · for up to 4 read/write heads type ANT41x/ANT51x · Housing materials: Upper part: PA Grivory GV-5H orange / Upper part: TPE / lower part: GD-ALSi12	2	DTE101
---	---	---	--------

DTE102 RFID system with EtherNet/IP

Type	Description	Draw- ing no.	Order no.
------	-------------	---------------------	--------------

Type DTE1 · M12 connector

	RFID evaluation unit · for up to 4 read/write heads type ANT41x/ANT51x · Housing materials: Upper part: PA Grivory GV-5H orange / Upper part: TPE / lower part: GD-ALSi12	2	DTE102
---	---	---	--------

DTE103 RFID system with EtherCAT

Type	Description	Draw- ing no.	Order no.
------	-------------	---------------------	--------------

Type DTE1 · M12 connector

	RFID evaluation unit · for up to 4 read/write heads type ANT41x/ANT51x · Housing materials: Upper part: PA Grivory GV-4H orange / Upper part: TPE / lower part: GD-ALSi12	2	DTE103
---	---	---	--------

DTE104 RFID system with Ethernet TCP/IP

Type	Description	Draw- ing no.	Order no.
------	-------------	---------------------	--------------

Type DTE1 · M12 connector

	RFID evaluation unit · for up to 4 read/write heads type ANT41x/ANT51x · Housing materials: Upper part: PA Grivory GV-5H orange / Upper part: TPE / lower part: GD-ALSi12	2	DTE104
---	---	---	--------



RFID antennas 13.56 MHz for system DTE100, DTE101, DTE102, DTE104

Type	Description	Draw- ing no.	Order no.
------	-------------	---------------------	--------------





	Read/write head · M12 connector · Housing materials: housing: stainless steel / Top: PPS	3	ANT410
---	--	---	--------



Identification systems

Type	Description	Draw- ing no.	Order no.
	Read/write head · M12 connector · Housing materials: housing: stainless steel / Top: PPS	4	ANT411
	Read/write head · M18 x 1 · M12 connector · Housing materials: housing: stainless steel / Top: PPS / connector housing: PEI	5	ANT420
	Read/write head · M18 x 1 · M12 connector · Housing materials: housing: stainless steel / Top: PPS / connector housing: PEI	6	ANT421
	Read/write head · M12 connector · Housing materials: housing: stainless steel / Top: PPS	7	ANT430
	Read/write head · M12 connector · Housing materials: housing: stainless steel / Top: PPS	8	ANT431
	Read/write head · M12 connector · 5 positions of the sensing face selectable · Housing materials: housing: PA / Metal parts: stainless steel	9	ANT513
	Read/write head · M12 connector · Cable with connector · 1 m · Housing materials: PBT / TPE-U / stainless steel	10	ANT515
	Read/write head · M12 connector · Cable with connector · 2 m · Housing materials: PBT / TPE-U / stainless steel	10	ANT516













RFID systems DTM424, DTM425, DTM434, DTM435 for mobile machines

Type	Description	Draw- ing no.	Order no.
Type M18 x 1 · M12 connector · CANopen interface			
	Read/write head · M18 x 1 · M12 connector · Housing materials: housing: stainless steel / Top: PPS / connector housing: PEI	11	DTM424
	Read/write head · M18 x 1 · M12 connector · Housing materials: housing: stainless steel / Top: PPS / connector housing: PEI	12	DTM425
Type M18 x 1 · M12 connector · J1939 interface			
	Read/write head · M18 x 1 · M12 connector · Housing materials: housing: stainless steel / Top: PPS / connector housing: PEI	11	DTM426
	Read/write head · M18 x 1 · M12 connector · Housing materials: housing: stainless steel / Top: PPS / connector housing: PEI	12	DTM427

Type	Description	Draw- ing no.	Order no.
Type M30 x 1.5 · M12 connector · CANopen interface			
	Read/write head · M30 x 1.5 · M12 connector · Housing materials: housing: stainless steel / Top: PPS / connector housing: PEI	13	DTM434
	Read/write head · M30 x 1.5 · M12 connector · Housing materials: housing: stainless steel / Top: PPS / connector housing: PEI	14	DTM435
Type M30 x 1.5 · M12 connector · J1939 interface			
	Read/write head · M30 x 1.5 · M12 connector · Housing materials: housing: stainless steel / Top: PPS / connector housing: PEI	13	DTM436
	Read/write head · M30 x 1.5 · M12 connector · Housing materials: housing: stainless steel / Top: PPS / connector housing: PEI	14	DTM437
RFID tags 13.56 MHz for antennas ANT513, ANT410, ANT411, ANT430, ANT431, DTM424, DTM425, DTM434, DTM435			
Type	Description		Order no.
	ID tag · ID-TAG/D12x2.3/06		E80341
	ID tag · Ø 34 x 6 mm · Housing materials: PPS		E80342
	ID tag · ID-TAG/D12x2.3/06 · 90 x 34 x 7 mm · Housing materials: ABS		E80343
	ID tag · ID-TAG/D16x3/06 · Ø 16 x 3 mm · Housing materials: PPS		E80344
	ID tag · ID-TAG/M5x16.5/01 · M5 x 16.5 mm · Screw mounting · Housing materials: PA black (RAL 9005)		E80347
	ID tag · ID-TAG/D20x3/06 · Ø 20 x 3 mm · Housing materials: PPA		E80349
	ID tag · ID-TAG/D40x31/06 · 40 x 31 x 5 mm · Housing materials: PC		E80387
	ID tag · ID-TAG/D12x2.3/06 · Ø 12.3 x 2.3 mm · Housing materials: PPA black		E80388



Identification systems



Type	Description	Order no.
	ID tag · ID-TAG/30X2.8/03 - 16 Kbit · Ø 30 x 2.8 mm · Housing materials: PA 6 black	E80370
	ID tag · ID-TAG/D50x3.0/0 FRAM-16 Kbit · Ø 50 x 3 mm · Housing materials: PPA black	E80383
	ID tag · ID-TAG/D50x3.0/0 1024bit · Ø 50 x 3 mm · Housing materials: PPA black	E80384
	ID tag · ID-TAG/30X2.8/03 - 64 Kbit · Ø 30 x 2.8 mm · Housing materials: PA 6	E80380
	ID tag · ID-TAG/30X2.5/06 - 896 bit · Ø 30 x 2.5 mm · Housing materials: PA 6 black	E80371
	ID tag · ID-TAG/R20X2.5/06 - 896 Bit · Ø 20 x 2.5 mm · Housing materials: PPA	E80377
	ID tag · ID-TAG/4.35X3.6/03 - 896 bit · Ø 4.3 x 3.6 mm · Housing materials: PPA GF30	E80381
	ID tag · ID-TAG/Label 65X30/03 - 896 bit	E80382
	ID tag · ID-TAG/Label 80x50/03 - 896 bit	E80379
	ID tag · ID-TAG/D22x4 · Ø 4 x 22 mm · Housing materials: glass	E80385
	ID tag · ID-TAG/51x51/06 · 51 x 51 x 6.5 mm · Housing materials: PPS	E80400
	Antenna adapter to increase the ranges · Housing materials: PVC	E80390
	Antenna adapter to increase the ranges · Housing materials: PVC	E80391
	Antenna adapter for a wider sensing field · Housing materials: POM	E80392
	ID tag · ID-TAG/HOLDER/01 · Housing materials: PPS black	E80401

Type	Description	Order no.
	ID tag · ID-TAG/TRIANGLE HOUSING/01 · with ID tag E80345 · Housing materials: PBT orange (RAL 2003) / PA black (RAL 9005)	E80348

Accessories DTE100

Type	Description	Order no.
	Terminating resistor plug · straight · Free from silicone · Free from halogen · Gold-plated contacts · Housing materials: PUR	E12315
	Jumper · straight / straight · Free from halogen · Gold-plated contacts · 10 m · Housing materials: PUR	E12317
	Cable plug · straight · Free from halogen · Gold-plated contacts · M12 connector · 10 m · Housing materials: PUR	E12319
	Socket · straight · Free from halogen · Gold-plated contacts · M12 connector · 10 m · Housing materials: PUR	E12321





Accessories DTM

Type	Description	Order no.
	BasicDisplay XL · 4.3" colour display · 6 freely programmable backlit function keys · Navigation key for cursor function · CAN interface · Programming according to IEC 61131-3 · 8...32 V DC	CR0452
	Socket · straight · Free from silicone · Free from halogen · Gold-plated contacts · For applications in particularly harsh environments · M12 connector · 2 m · Housing materials: housing: TPU orange / sealing: FKM	EVM036
	Socket · straight · Free from silicone · Free from halogen · Gold-plated contacts · For applications in particularly harsh environments · M12 connector · 10 m · Housing materials: housing: TPU orange / sealing: FKM	EVM038
	Socket · angled · Free from silicone · Free from halogen · Gold-plated contacts · M12 connector with integrated CAN terminating resistor (120 ohm) · 5 m · Housing materials: housing: TPU black / sealing: FKM	EVC492
	Jumper · angled / angled · Free from silicone · Free from halogen · Gold-plated contacts · 5 m · Housing materials: housing connector: TPU orange / housing socket: TPU black transparent / sealing: FKM	EVC039
	Jumper · angled / straight · Free from silicone · Free from halogen · Gold-plated contacts · 5 m · Housing materials: housing: TPU orange / sealing: FKM	EVC069



Identification systems

Connection technology

Type	Description	Order no.
	Jumper · straight / straight · Ethernet · Cross-over patch cable · 2 m · Housing materials: PUR / PC	E11898
	Jumper · straight / straight · Ethernet · Cross-over patch cable · 2 m · Housing materials: TPU / PA	E12090
	Jumper · straight / straight · Ethernet · 10 m · Housing materials: PUR / PC	E12204
	Jumper · straight / straight · Ethernet · 20 m · Housing materials: PUR / PC	E12205

Scale drawings / drawing no. – CAD download: www.ifm.com

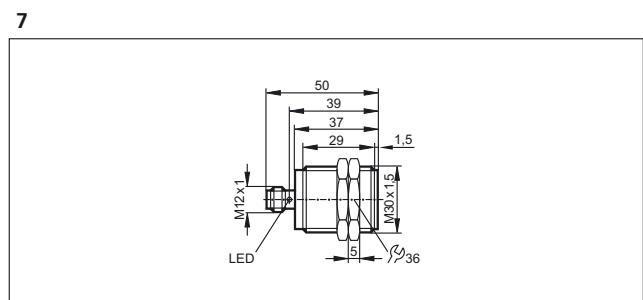
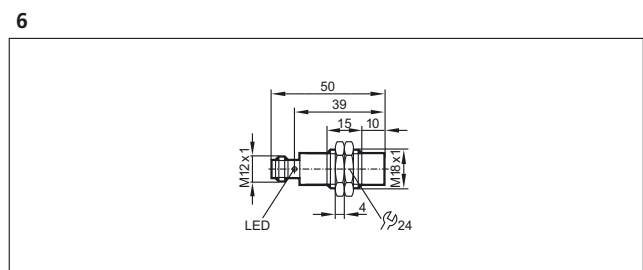
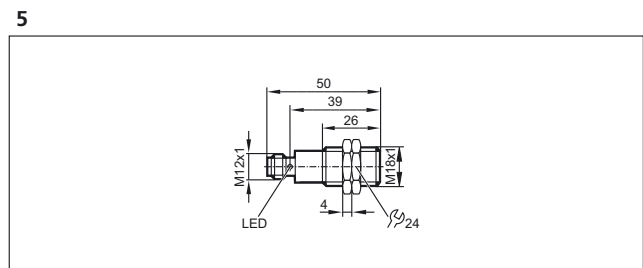
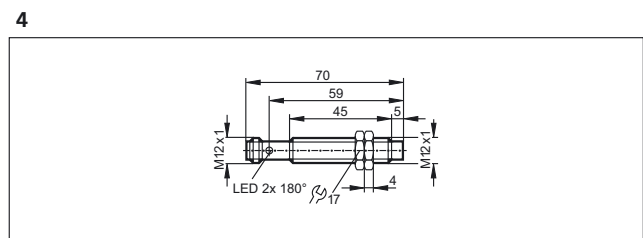
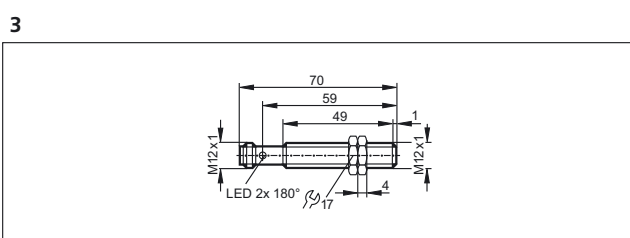
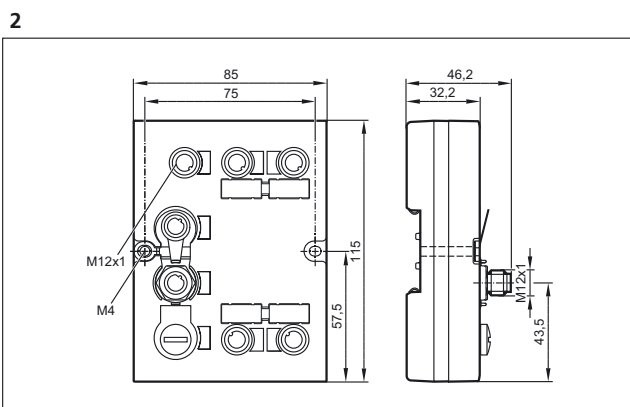
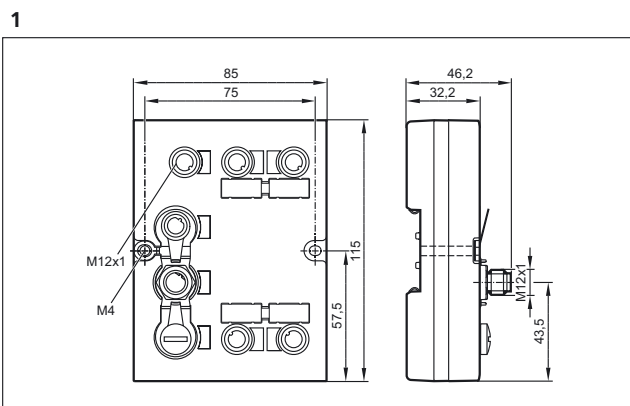

Scale drawings / drawing no. – CAD download: www.ifm.com

8

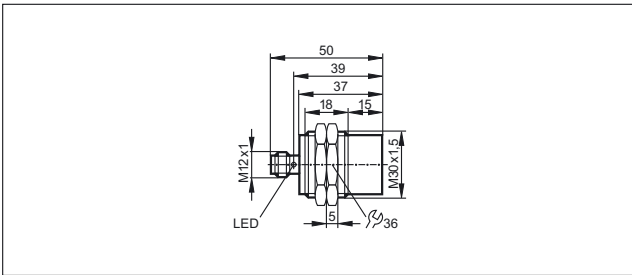

11

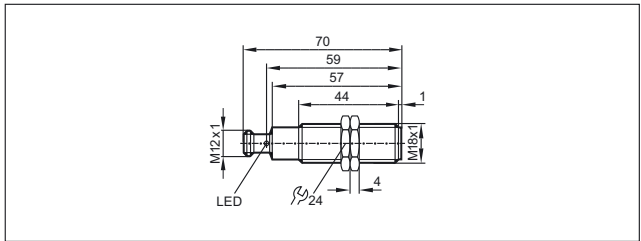

9

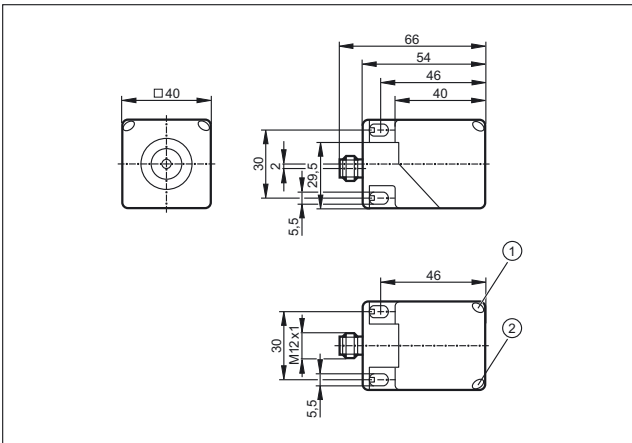

1: LED yellow, 2: LED green

12

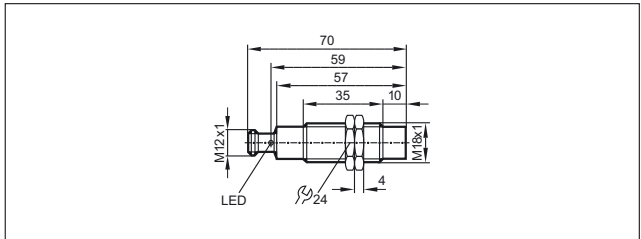

13

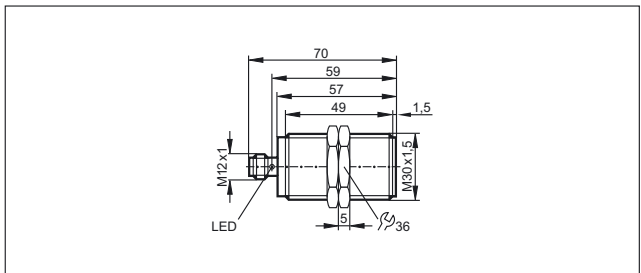

10

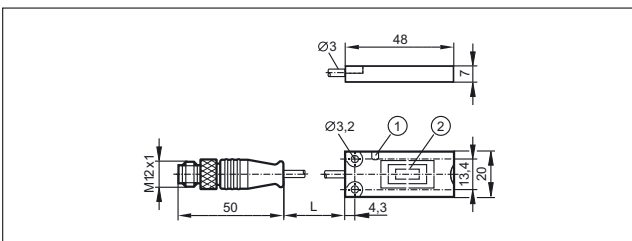

1: LED, 2: sensing face

14

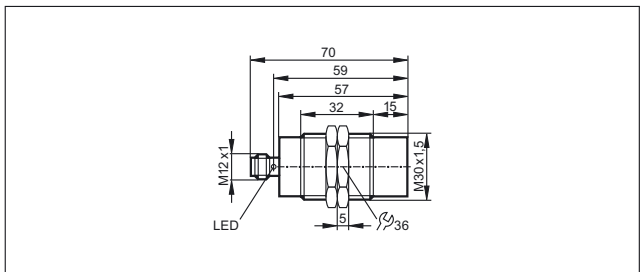



Identification systems



RFID UHF

The system is optimised for applications in production control, asset management, material flow control, track & trace and supply chain management:





- System DTE 800 for EU/ETSI
- System DTE 810 with Ethernet/IP
- System DTE 900 for US/FCC
- System DTE 910 with Ethernet/IP

System overview	Page
RFID UHF readers	674
RFID UHF antennas	675
ID tags UHF	675
Accessories for UHF systems	675 - 676
Scale drawings / drawing no. – CAD download: www.ifm.com	676 - 677



RFID UHF readers

Type	Dimensions [mm]	Operating frequency [MHz]	Trans- mission power [mW ERP]	Number of antenna inputs	Process interface	Output	Draw- ing no.	Order no.
M12 connector · Connector groups 8, 10, 19, 21, 23, 25, 148, 149, 153, 184, 188, 193, 202								
	233.5 x 270 x 68	865-868 (ETSI)	2000	4	EtherNet/IP	–	1	DTE810
	233.5 x 270 x 68	902...928 (FCC)	2000	4	EtherNet/IP	–	1	DTE910
	233.5 x 270 x 68	916...927	2000	4	EtherNet/IP	–	1	DTE920
M12 connector · Connector group --								
	138.1 x 63 x 156	865-868 (ETSI)	266	–	Ethernet TCP/IP	–	2	DTE820

RFID UHF antennas

Type	Dimensions [mm]	Operating frequency [MHz]	Antenna gain [cBic]	Max. input power [mW]	Protection	Drawing no.	Order no.
TNC socket							
	63 x 28 x 90	865...928	-30	1000	IP 67	3	ANT805
	63 x 28 x 90	865...870	-15	500	IP 67	3	ANT810
	126 x 37 x 156	865...928	-12 (866 MHz) / -10 (915 MHz)	-	IP 67	4	ANT815
	126 x 37 x 156	865...870	2.5	-	IP 67	4	ANT820
	271 x 270 x 42	865...870	8.5	-	IP 65	5	ANT830
	63 x 28 x 90	902...928 (FCC)	-15	500	IP 67	3	ANT910
	271 x 270 x 42	902...928 (FCC)	8.3	-	IP 65	5	ANT930

ID tags UHF

Type	Description	Order no.
	ID tag · ID-TAG/D55x13/04 · Ø 55 x 13 mm · Housing materials: PA 6	E80351
	ID tag · ID-TAG/R30X10/04 · Ø 30 x 10 mm · Housing materials: PU black	E80353
	ID tag · ID-TAG/R40X10/04 · 40 x 32 x 8 mm · Housing materials: nylon black	E80354

Accessories for UHF systems

Type	Description	Order no.
	Jumper · straight / straight · For RFID antenna · 3 m	E80330



Identification systems

Type	Description	Order no.
	Jumper · straight / straight · For RFID antenna · 6 m	E80331
	Jumper · straight / straight · For RFID antenna · 10 m	E80332
	Jumper · straight / straight · For RFID antenna · 15 m	E80333
	Jumper · straight / straight · Ethernet · Cross-over patch cable · 2 m · Housing materials: PUR / PC	E11898
	Jumper · straight / straight · Ethernet · 10 m · Housing materials: PUR / PC	E12204
	Clamp · for RFID UHF readers DTE800/DTE900 and antennas ANT830/ANT930 · Housing materials: fixture: steel sheet galvanised / screws: stainless steel / Fixing strap: stainless steel	E80340

Scale drawings / drawing no. – CAD download: www.ifm.com

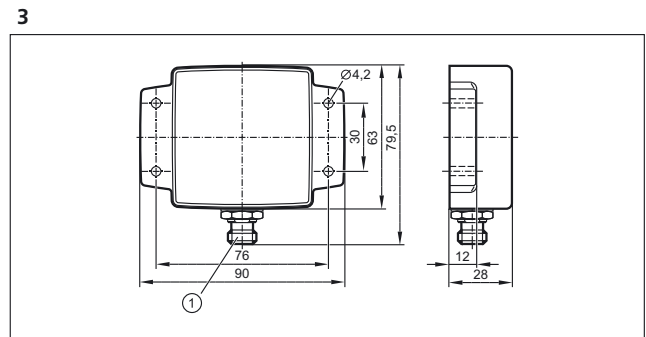
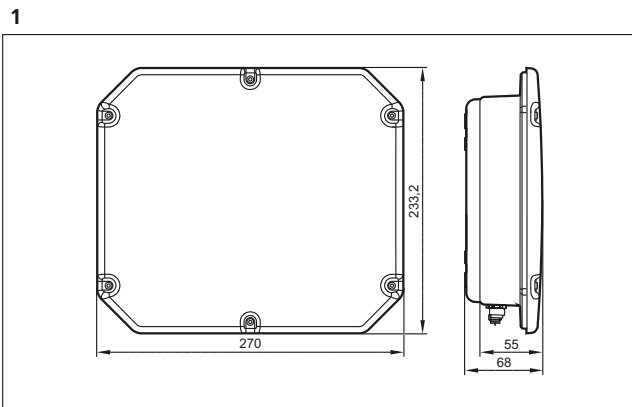

1: TNC socket

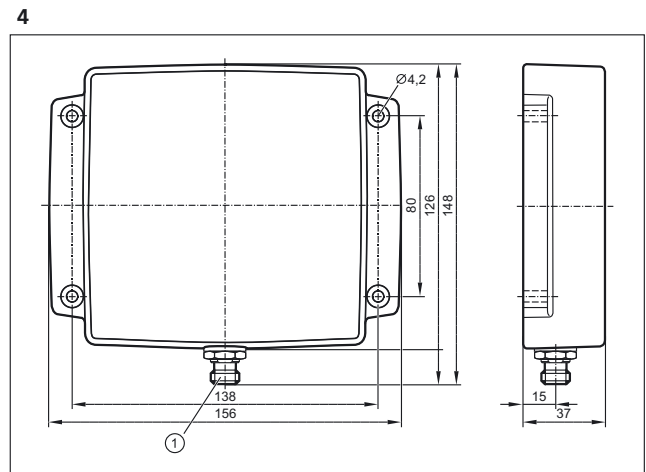
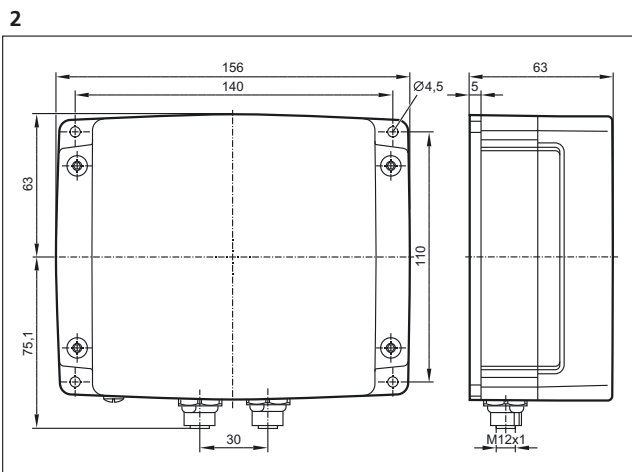

1: TNC socket

Scale drawings / drawing no. – CAD download: www.ifm.com

5

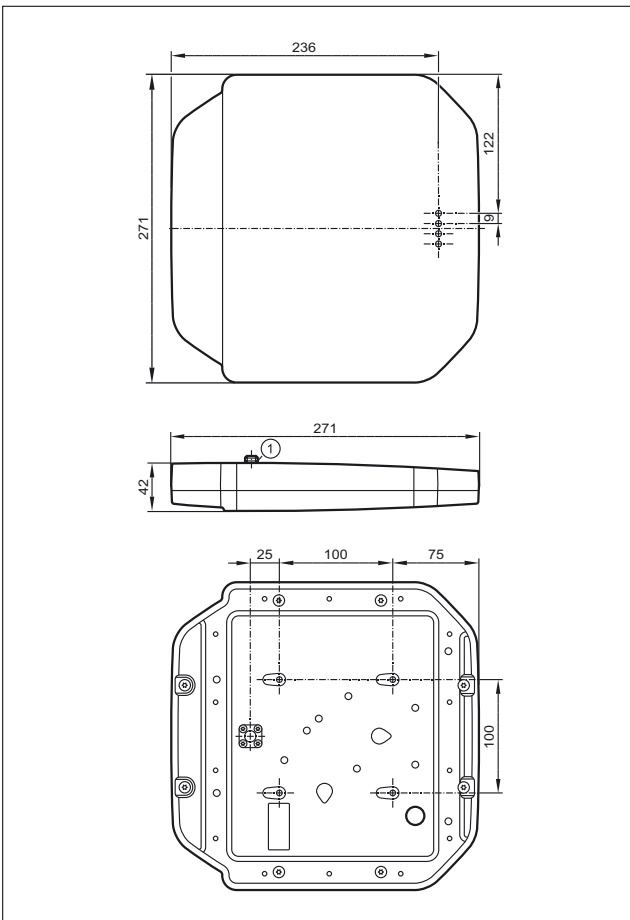

1: TNC socket



Identification systems



1D/2D code readers

Photoelectric multicode reader for 1D bar codes and 2D codes. Versions with infrared light and red light as well as different field of view sizes are available.

System overview	Page
Multicode reader	678 - 679
Multicode reader with text recognition	679
Illumination units	679 - 680
Software	680
Panel PC for Multicode Reader	680
Fixing components	680 - 681
Protective panes and diffusers	682
Connection technology	682
Wiring diagrams	682
Scale drawings / drawing no. – CAD download: www.ifm.com	683

Multicode reader

Type	Dimensions [mm]	Max. field of view size [mm]	Type of light LED	Motion speed int. / ext. lighting [m/s]	Process interface	Draw- ing no.	Order no.
Multicode Reader · M12 plug, 8 poles · M12 socket, 4 poles · Connector groups 16, 17, 157, 183							
	60 x 42 x 53.5	64 x 48	red light	3 / 5	Ethernet TCP/IP, EtherNet/IP, RS-232	1	O2I300
	60 x 42 x 53.5	132 x 94	red light	3 / 5	Ethernet TCP/IP, EtherNet/IP, RS-232	1	O2I302
	60 x 42 x 59	400 x 300	red light	3 / 5	Ethernet TCP/IP, EtherNet/IP, RS-232	2	O2I304
	60 x 42 x 53.5	64 x 48	infrared	3 / 5	Ethernet TCP/IP, EtherNet/IP, RS-232	1	O2I301
	60 x 42 x 53.5	132 x 94	infrared	3 / 5	Ethernet TCP/IP, EtherNet/IP, RS-232	1	O2I303

Type	Dimensions [mm]	Max. field of view size [mm]	Type of light LED	Motion speed int. / ext. lighting [m/s]	Process interface	Drawing no.	Order no.
------	--------------------	---------------------------------	----------------------	--	-------------------	-------------	-----------







Multicode Reader · M12 plug, 8 poles · M12 socket, 4 poles · Connector groups 16, 17, 157, 183

	60 x 42 x 59	400 x 300	infrared	3 / 5	Ethernet TCP/IP, EtherNet/IP, RS-232	2	O2I305
---	--------------	-----------	----------	-------	---	---	---------------

Multicode reader with text recognition

Type	Dimensions [mm]	Max. field of view size [mm]	Type of light LED	Motion speed int. / ext. lighting [m/s]	Process interface	Drawing no.	Order no.
------	--------------------	---------------------------------	----------------------	--	-------------------	-------------	-----------



Multicode Reader · M12 plug, 8 poles · M12 socket, 4 poles · Connector groups 16, 17, 157, 183

	60 x 42 x 53.5	–	red light	3 / 5	Ethernet	1	O2I350
	60 x 42 x 53.5	–	red light	3 / 5	Ethernet	1	O2I352
	60 x 42 x 59	–	red light	3 / 5	Ethernet	2	O2I354
	60 x 42 x 53.5	–	infrared	3 / 5	Ethernet	1	O2I351
	60 x 42 x 53.5	–	infrared	3 / 5	Ethernet	1	O2I353
	60 x 42 x 59	–	infrared	3 / 5	Ethernet	2	O2I355

Illumination units

Type	Dimensions [mm]	Type of light	Active illuminated area [mm]	I ₀ normal light intensity [mA]	I ₀ high light intensity [mA]	Trigger	Drawing no.	Order no.
------	--------------------	---------------	---------------------------------	---	---	---------	-------------	-----------

M12 connector · metal · DC · Wiring diagram no. 1 · Connector groups 8, 10, 19, 21, 23, 25, 148, 149, 153, 184, 188, 193, 202



	42 x 42 x 31	Red	–	180	90	External; 24 V PNP to IEC61131-1	3	O2D909
	42 x 42 x 32.2	Red	–	180	90	External; 24 V PNP to IEC61131-1	4	O2D913

PUR cable with M12 connector 0.3 m · metal · DC · Wiring diagram no. 1 · Connector groups 8, 10, 19, 21, 23, 25, 148, 149, 153, 184, 188, 193, 202

	∅ 122 / L = 20.5	Infrared	–	800	1400	external; 24 V PNP	5	O2D917
---	------------------	----------	---	-----	------	--------------------	---	---------------

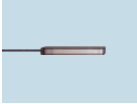

Identification systems

Type	Dimensions [mm]	Type of light	Active illuminated area [mm]	I ₀ normal light intensity [mA]	I ₀ high light intensity [mA]	Trigger	Draw- ing no.	Order no.
PUR cable with M12 connector 0.3 m · metal · DC · Wiring diagram no. 1 · Connector groups 8, 10, 19, 21, 23, 25, 148, 149, 153, 184, 188, 193, 202								
	116 x 13 x 18	Infrared	–	185	325	external; 24 V PNP	6	O2D922
	200 x 13 x 18	Infrared	–	415	640	external; 24 V PNP	7	O2D925

Software













Type	Description	Number of connections	Order no.
	Operating software · O2I · for multicode reader · Create and manage application-specific configurations Monitor mode for set-up and service · Service reports for statistical evaluations	–	E2I200
	Multicode reader OPC server · Software · German/English	25	E2I210
	Multicode reader OPC server · Software · German/English	50	E2I211
	Multicode reader OPC server · Software · German/English	75	E2I212
	Multicode reader OPC server · Software · German/English	100	E2I213

Panel PC for Multicode Reader

Type	Description	Order no.
	Touch Panel PC · 12.1" colour display · Intel Atom CPU 1.6 GHz · 2 GByte RAM · Windows Embedded Standard 7 SP1 (32 bits)	E2D400

Fixing components

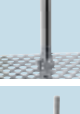

Type	Description	Order no.
	Mounting set · O2D, O2M, O2I, O2V · Clamp mounting · rod mounting Ø 12 mm · Housing materials: fixture: stainless steel / clamp: stainless steel	E2D110
	Mounting set · O2D, O2M, O2I, O2V · Clamp mounting · rod mounting Ø 14 mm · Housing materials: fixture: stainless steel / clamp: stainless steel	E2D112

Type	Description	Order no.
	Mounting set · Clamp mounting · Housing materials: Mounting bracket: stainless steel / clamp: high-grade stainless steel	E2D114
	Mounting set · Clamp mounting · for 4 bar lights 10x75 mm · Housing materials: Mounting bracket: stainless steel / clamp: high-grade stainless steel	E2D116
	Mounting set · Ring light · Clamp mounting · Housing materials: Mounting bracket: stainless steel / clamp: high-grade stainless steel	E2D201
	clamp · Ø 12 mm; M10 · Free-standing M10 · Housing materials: clamp: stainless steel	E20946
	clamp · Ø 12 mm · rod mounting Ø 12 mm · Housing materials: clamp: stainless steel	E21110
	clamp · Ø 14 mm; M12 · free-standing M12 · Housing materials: clamp: stainless steel	E20948
	clamp · Ø 14 mm · rod mounting Ø 14 mm · Housing materials: clamp: stainless steel	E21109
	mounting rod · Ø 12 · Length: 200 mm · straight · Housing materials: stainless steel 316Ti / 1.4571	E21112
	mounting rod · Ø 12 · Length: 300 mm · straight · Housing materials: stainless steel 316Ti / 1.4571	E21113
	mounting rod · Ø 12 / M10 · Length: 130 mm · straight · Housing materials: stainless steel 316Ti / 1.4571	E20938
	mounting rod · Ø 12 / M10 · Length: 200 mm · angled · Housing materials: stainless steel 316Ti / 1.4571	E20940
	mounting rod · Ø 14 / M12 · Length: 130 mm · straight · Housing materials: stainless steel 316Ti / 1.4571	E20939
	mounting rod · Ø 14 / M12 · Length: 200 mm · angled · Housing materials: stainless steel 316Ti / 1.4571	E20941
	Connection piece · Ø 20 mm · for the connection of two clamps with Ø 20 mm · Housing materials: stainless steel 316L / 1.4404	E21076





Identification systems

Protective panes and diffusers

Type	Description	Order no.
	Plastic diffuser · O2D / O2I · Housing materials: housing: diecast zinc black / lens: PMMA	E21165
	Plastic protective pane for the food industry · O2D / O2I · Housing materials: housing: diecast zinc black / lens: PMMA	E21166
	Glass protective pane · O2D / O2I · Housing materials: housing: diecast zinc black / lens: float glass	E21168
	Laser protection pane plastic · O2D / O2I · Housing materials: housing: diecast zinc black / lens: PMMA / filter: polycarbonate	E21169

Connection technology

Type	Description	Order no.
	Jumper · straight / straight · Ethernet · Cross-over patch cable · 2 m · Housing materials: PUR / PC	E11898
	Jumper · straight / straight · Ethernet · Cross-over patch cable · 2 m · Housing materials: TPU / PA	E12090
	Jumper · straight / straight · Ethernet · 10 m · Housing materials: PUR / PC	E12204
	Jumper · straight / straight · Ethernet · 20 m · Housing materials: PUR / PC	E12205

Wiring diagrams

1

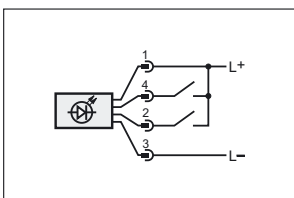

1: Trigger, 2: Operating mode
"high light intensity"

Scale drawings / drawing no. – CAD download: www.ifm.com

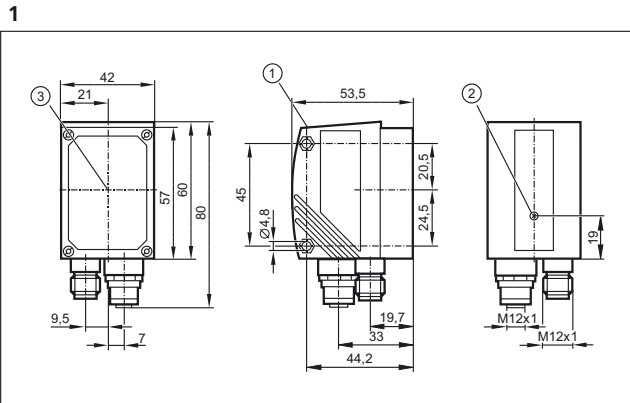

1: display, 2: Focus adjustment screw, 3: Centre of the lens axes

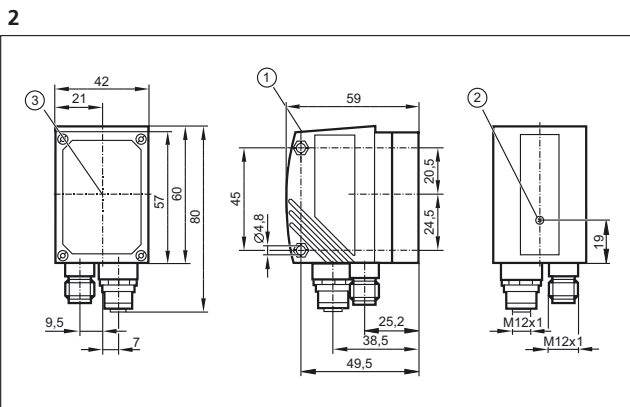

1: display, 2: Focus adjustment screw, 3: Centre of the lens axes

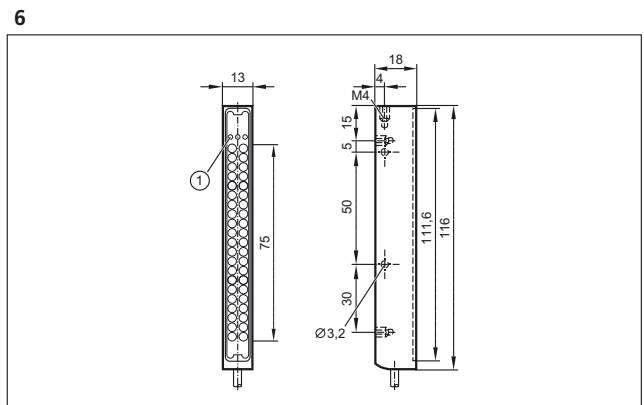
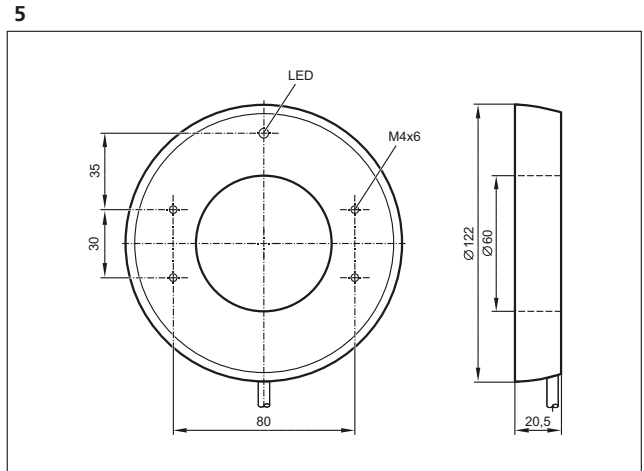
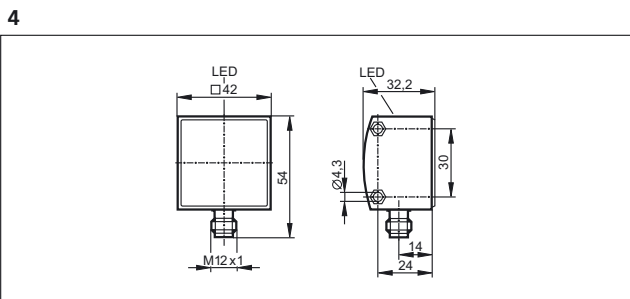
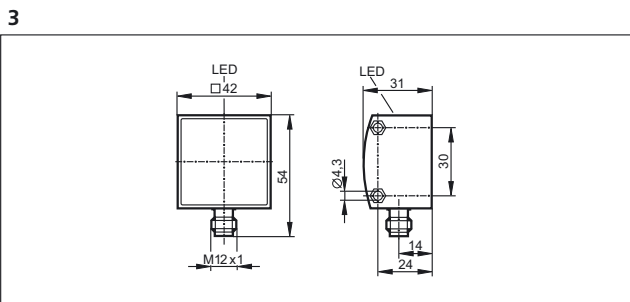

1: LED

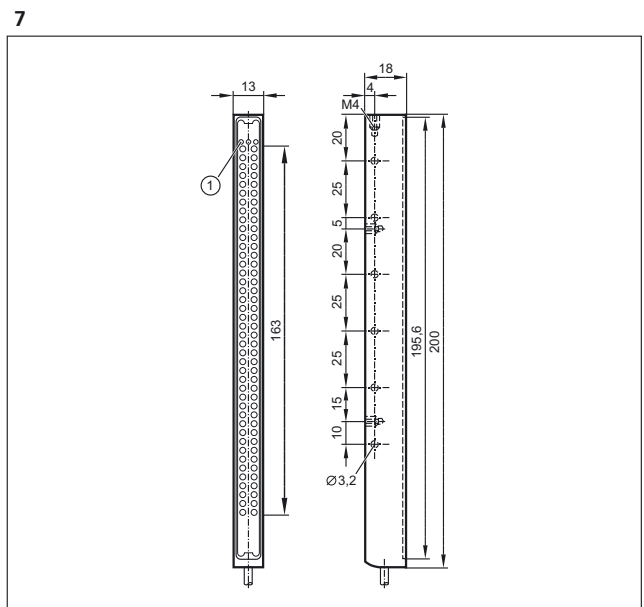

1: LED



Early damage detection – Downtime prevention



Systems for vibration monitoring – the optimum solution for every requirement.

Vibration monitoring

Monitoring of overall vibration according to ISO 10816. Detects resulting damage at an early stage. Avoids consequential damage and increases life-time.

Condition monitoring

Early detection of potential faults and their causes based on individual vibration characteristics and other influencing factors.

Machine protection

Avoids damage to machine components, tools or workpieces via permanent monitoring and very short response times. The integration into the PLC makes it possible to adjust the vibration monitoring to the process of the machine or the plant.

Oil quality under control

The quality of oil is decisive for many machines for their precision and life span. The combined oil humidity and temperature sensor is designed for permanent monitoring and signalling of measurement data via analogue outputs. This makes it possible to avoid damage caused by inappropriate lubrication and to plan ideal maintenance intervals.



Vibration monitoring systems

686 - 691



Systems for oil quality monitoring

692 - 694





Condition monitoring systems



Vibration monitoring systems



efector octavis is a simple to implement vibration monitoring system which detects vibration data and automatically determines the machine diagnosis directly on the machine.

The machine condition is forwarded to the PLC or to SCADA systems.

It fulfils the main requirements for modern machine monitoring: compatibility, modularity, and transferable configuration.

System overview	Page
Vibration sensors for vibration monitoring of machines and plants to ISO 10816 type VK	686
Accessories VK	686
Vibration transmitters for vibration monitoring of machines and plants to ISO 10816 type VT	687
Vibration transmitter with ATEX approval 3D/3G	687
Compact vibration sensors type VN	687
Accessories VN	687 - 688
Diagnostic electronics – control cabinet modules for vibration diagnosis type VSE	688
Accessories VSE	688
Connection cables VSE	689
Vibration sensors for connection to external diagnostic electronics VSE – type VSA / VSP	689
Accessories VSA	690
Scale drawings / drawing no. – CAD download: www.ifm.com	690 - 691

Vibration sensors for vibration monitoring of machines and plants to ISO 10816 type VK

Type	Description	Draw- ing no.	Order no.
	M8 x 1.25 · Vibration monitor to DIN ISO 10816 · Measuring range RMS: 0...25 mm/s · Switching output NC DC PNP and analogue output 4...20 mA · 2 Inputs / outputs total · Measuring range 0...25 RMS mm/s · Frequency range 10...1000 Hz · Ambient temperature -25...80 °C · M12 connector · Operating voltage 18...32 V DC · IP 67	1	VKV021
	M8 x 1.25 · Vibration monitor to DIN ISO 10816 · Measuring range RMS: 0...50 mm/s · Switching output NC DC PNP and analogue output 4...20 mA · 2 Inputs / outputs total · Measuring range 0...50 RMS mm/s · Frequency range 10...1000 Hz · Ambient temperature -25...80 °C · M12 connector · Operating voltage 18...32 V DC · IP 67	1	VKV022

Accessories VK

Type	Description	Order no.
	Protective cover · with lead seal option · for pressure sensors type PK · for temperature sensors type TK · for vibration sensors type VK · Housing materials: PP transparent	E30094

Vibration transmitters for vibration monitoring of machines and plants to ISO 10816 type VT

Type	Description	Draw- ing no.	Order no.
	set screw · Vibration transmitter to ISO 10816 · Measuring range RMS: 0...25 mm/s · Analogue output 4...20 mA · 2-wire connection technology · 1 Inputs / outputs total · Frequency range 10...1000 Hz · Ambient temperature -30...125 °C · M12 connector · Operating voltage 9.6...32 V DC · IP 67 / IP 68 / IP 69K	2	VTV122
	set screw · Vibration transmitter to ISO 10816 · Measuring range RMS: 0...50 mm/s · Analogue output 4...20 mA · 2-wire connection technology · 1 Inputs / outputs total · Frequency range 10...1000 Hz · Ambient temperature -30...125 °C · M12 connector · Operating voltage 9.6...32 V DC · IP 67 / IP 68 / IP 69K	2	VTV121



Vibration transmitter with ATEX approval 3D/3G

Type	Description	Draw- ing no.	Order no.
	set screw · Vibration transmitter to ISO 10816 · Measuring range RMS: 0...25 mm/s · Analogue output 4...20 mA · 2-wire connection technology · ATEX approval · Group II, category 3D/3G · 1 Inputs / outputs total · Frequency range 10...1000 Hz · Ambient temperature -20...60 °C · M12 connector · Operating voltage 9.6...32 V DC · IP 67	2	VTV12A

Compact vibration sensors type VN

Type	Description	Draw- ing no.	Order no.
	Mounting set M5 / M8 · Vibration sensor to ISO 10816 · Parameter setting via pushbuttons · 3 Inputs / outputs total, configurable · Analogue input 4...20 mA · Measuring range 0...500 mm/s · Frequency range 2...1000 Hz · 4-digit alphanumeric display · Ambient temperature -30...60 °C · M12 connector · M8 connector · Operating voltage 9.6...30 V DC · IP 67	3	VNB001
	Mounting set M5 / M8 · Vibration sensor to ISO 10816 · Parameter setting via pushbuttons · 3 Inputs / outputs total, configurable · Analogue input 0/4...20 mA · Measuring range 0...25 g · Frequency range 0...6000 Hz · 4-digit alphanumeric display · Ambient temperature -30...60 °C · M12 connector · M8 connector · Operating voltage 9.6...30 V DC · IP 67	3	VNB211

Accessories VN



Type	Description	Order no.
	USB adapter cable · straight / straight · 5 m	E30136
	Adapter · ¼" 28 UNF x M5 · Housing materials: stainless steel	E30137
	Power supply · 2 m · Housing materials: PPE	E30080





Condition monitoring systems

Type	Description	Order no.
	Y connection cable · 2 way · Free from halogen · 0.25 m · Housing materials: TPU	E12405

Diagnostic electronics – control cabinet modules for vibration diagnosis type VSE

Type	Description	Draw- ing no.	Order no.
	Diagnostic electronics for vibration sensors · Mounting on DIN rail · Integrated history memory with real-time clock · Counter function · TCP/IP Ethernet interface · Active wire break detection and self-test (only MEMS) of the connected acceleration sensors · Parameter setting via PC software VES004 · 8 Inputs / outputs total, configurable · Frequency range 0 / 2 / 10...12000 Hz · Ambient temperature 0...70 °C · Operating voltage 24 V DC ± 20 % · IP 20	4	VSE002
	Diagnostic electronics for vibration sensors · Mounting on DIN rail · Integrated history memory with real-time clock · Counter function · TCP/IP Ethernet interface · Active wire break detection and self-test (only MEMS) of the connected acceleration sensors · Parameter setting via PC software VES004 · 16 Inputs / outputs total, configurable · Frequency range 0...12000 Hz · Ambient temperature 0...70 °C · Operating voltage 24 V DC ± 20 % · IP 20	5	VSE100
	Diagnostic electronics for vibration sensors · Mounting on DIN rail · Parameter setting via PC software VES004 · TCP/IP Ethernet interface · Profinet IO data interface · 8 Inputs / outputs total, configurable · Ambient temperature 0...60 °C · Operating voltage 24 V DC ± 20 % · IP 20	6	VSE150





Accessories VSE

Type	Description	Number of connections	Order no.
	Parameter setting software VSExxx and VNBxxx · Version 1.21	–	VES004
	octavis OPC server · Software · German/English	25	VOS001
	octavis OPC server · Software · German/English	50	VOS002
	octavis OPC server · Software · German/English	75	VOS003
	octavis OPC server · Software · German/English	100	VOS004
	octavis OPC server · Software · German/English	1000	VOS005

Connection cables VSE

Type	Description	Order no.
	Jumper · straight / straight · Ethernet · Cross-over patch cable · 2 m · Housing materials: PUR	EC2080
	Jumper · straight / straight · Ethernet · Cross-over patch cable · 5 m · Housing materials: PUR	E30112



Vibration sensors for connection to external diagnostic electronics VSE – type VSA / VSP

Type	Description	Draw- ing no.	Order no.
	Accelerometer · M8 x 1.25 · for connection to external diagnostic electronics type VSE · Measuring range ± 25 g · Frequency range 0...6000 Hz · Ambient temperature -30...125 °C · M12 connector · Operating voltage 7.2...10.8 V DC · IP 68 / IP 69K	7	VSA001
	Accelerometer · for connection to external diagnostic electronics type VSE · Measuring range ± 3.3 g · Frequency range 0...1000 Hz · Ambient temperature -30...125 °C · M12 connector · Operating voltage 9 V DC · IP 68 / IP 69K	7	VSA101
	Accelerometer · M8 x 1.25 · for connection to external diagnostic electronics type VSE · Measuring range ± 250 g · Frequency range 0...6000 Hz · Ambient temperature -30...125 °C · M12 connector · Operating voltage 9 V DC · IP 68 / IP 69K	7	VSA201
	Accelerometer · M16 x 1.5 · for connection to external diagnostic electronics type VSE · Measuring range ± 25 g · Frequency range 0...10000 Hz · Ambient temperature -30...85 °C · PUR cable with M12 connector, 0.8 m · Operating voltage 9 V DC · IP 67	8	VSA002
	Accelerometer · M16 x 1.5 · for connection to external diagnostic electronics type VSE · Measuring range ± 25 g · Frequency range 0...10000 Hz · Ambient temperature -30...85 °C · PUR cable, 6 m · Operating voltage 9 V DC · IP 67	8	VSA006
	Accelerometer · Mounting screw · for connection to external diagnostic electronics type VSE · Measuring range ± 25 g · Frequency range 0...10000 Hz · Ambient temperature -30...100 °C · PUR cable, 3 m · Operating voltage 9 V DC · IP 67	9	VSA004
	Accelerometer · Mounting screw · for connection to external diagnostic electronics type VSE · Measuring range ± 25 g · Frequency range 0...10000 Hz · Ambient temperature -30...100 °C · PUR cable, 10 m · Operating voltage 9 V DC · IP 67	9	VSA005
	Accelerometer · set screw · for connection to external diagnostic electronics type VSE · Measuring range ± 50 g · Frequency range 2...10000 Hz · Ambient temperature -55...125 °C · M12 connector · Operating voltage 10...12 V DC · IP 67	10	VSP001
	Accelerometer · M8 x 1.25 · for connection to external diagnostic electronics type VSE · Measuring range ± 50 g · Frequency range 1.5...16000 Hz · Ambient temperature -55...130 °C · M12 connector · Operating voltage 10...12 V DC · IP 67	11	VSP003
	Accelerometer · M8 x 1.25 · ATEX approval · IECEx approval · Group II, category 1D · Group II, category 1G · For connection to VSExxx type external diagnostic electronics via safety barrier · Measuring range ± 50 g · Frequency range 2...10000 Hz · Ambient temperature -55...90 °C · PUR cable, 10 m · Operating voltage 10...12 V DC · IP 68	12	VSP01A
	Accelerometer · M8 x 1.25 · ATEX approval · IECEx approval · group 1, M1 · For connection to VSExxx type external diagnostic electronics via safety barrier · Measuring range ± 50 g · Frequency range 2...10000 Hz · Ambient temperature -55...90 °C · PUR cable, 10 m · Operating voltage 10...12 V DC · IP 68	12	VSP02A
	Accelerometer · M8 x 1.25 · for connection to VNB211 vibration sensors · Measuring range ± 25 g · Frequency range 0...6000 Hz · Ambient temperature -30...125 °C · M12 connector · Operating voltage 7.2...30 V DC · IP 68 / IP 69K	7	VNA001



Condition monitoring systems

Accessories VSA

Type	Description	Order no.
	conical washer · Ø 8.4 / 15 mm · for vibration sensors VSA001, VSA101, VSA201 · Housing materials: stainless steel 316Ti / 1.4571	E30115
	Adapter · M8-M8 · for vibration sensors VSA001, VSA101, VSA201 · Electrical isolation · Housing materials: PEEK	E30132

Scale drawings / drawing no. – CAD download: www.ifm.com

1

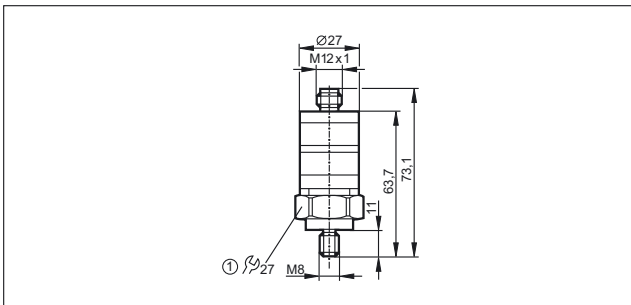

1: tightening torque 15 Nm

2

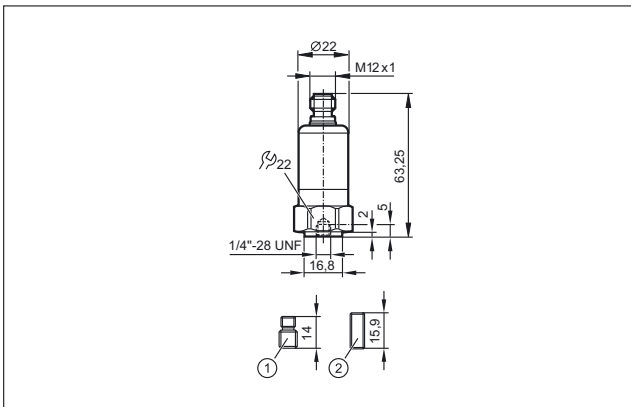

1: Threaded adapter 1/4"-28 UNF / M8 x 1.25 mm, 2: Threaded adapter 1/4"-28 UNF, tightening torque 8 Nm

3

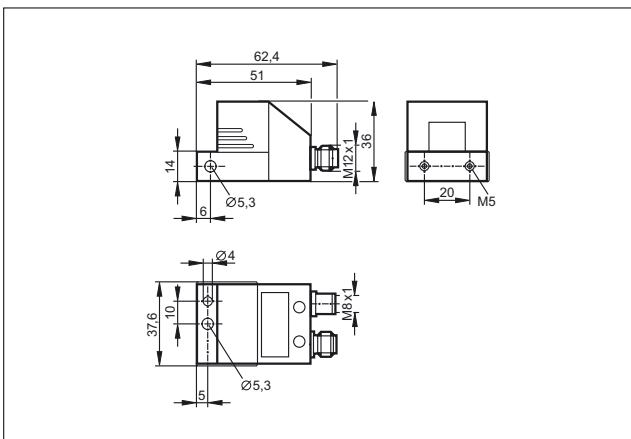

4

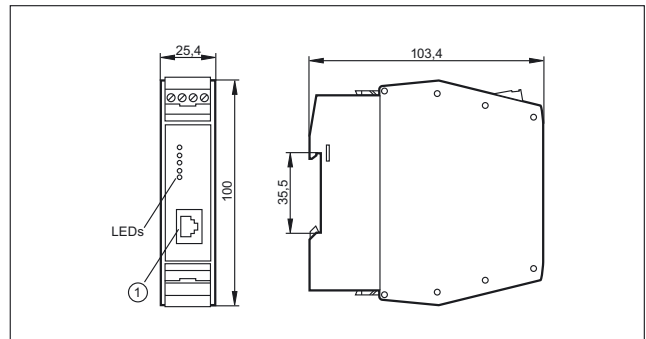

1: Ethernet interface

5

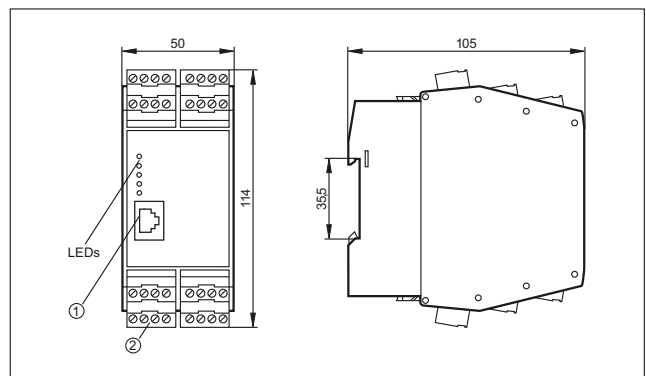

1: Ethernet interface, 2: Combicon plug with screw terminals (optional)

6

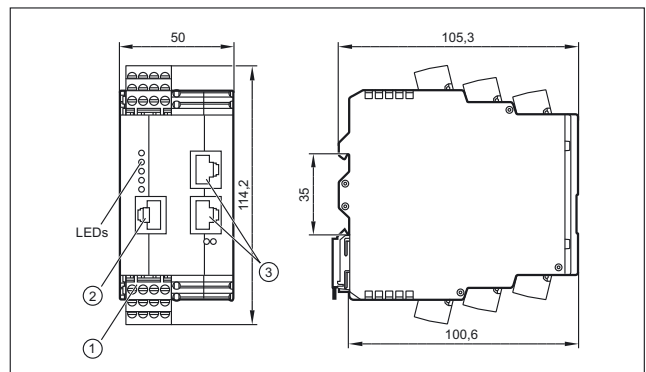

1: Combicon connector, 2: TCP/IP interface, 3: Profinet IO data interface

Scale drawings / drawing no. – CAD download: www.ifm.com

7

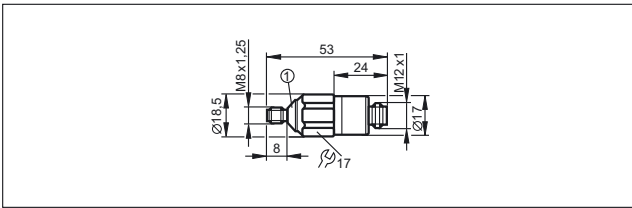

1: conical angle = 90°

8

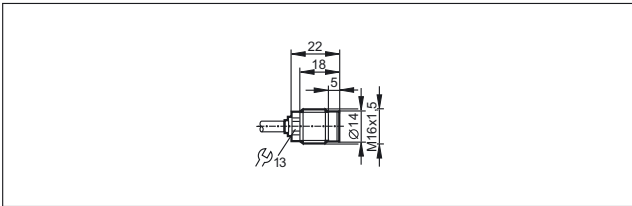

9

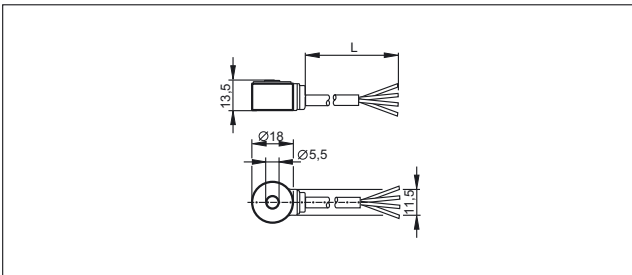

10

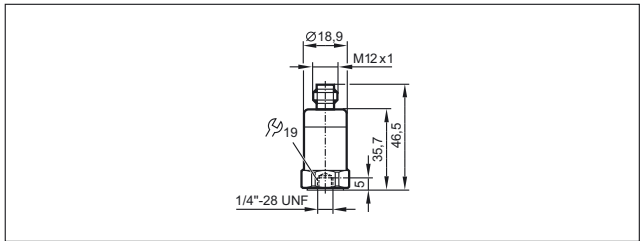

11

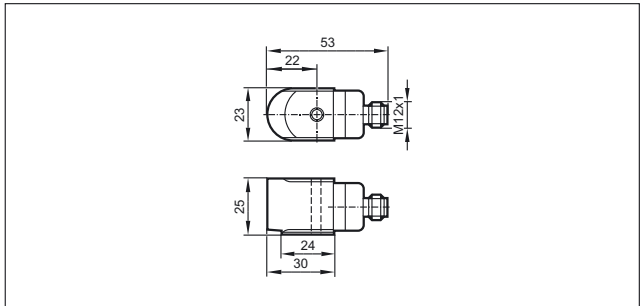

12

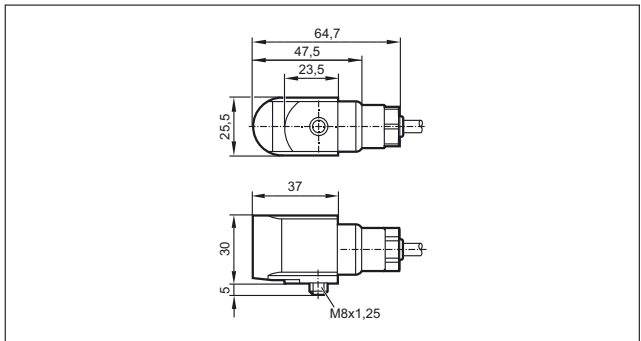



Condition monitoring systems



Systems for oil quality monitoring

For an early detection of too high a water content in lubricants and oils it is useful to continuously monitor the relative moisture in the media using a sensor.

The sensor measures the relative moisture in the oil in the range of 0...100 % by means of a capacitive measuring element. Besides the relative moisture the sensor also provides the medium temperature as an analogue signal.

LDP100 monitors the degree of cleanliness or the level of contamination in fluids. Compatible media are mineral oils, ester oils and biodegradable oils. The calibration is made in accordance with ISO 11943.

The purity classes are indicated on the LCD display and provided via analogue output and CAN bus

System overview	Page
Oil particle sensor	692
Oil moisture sensor	692
Accessories for LDP oil particle monitor	693
Accessories for oil moisture sensor LDH	693
Wiring diagrams	693
Scale drawings / drawing no. – CAD download: www.ifm.com	694

Oil particle sensor

Type	Process connection	Pressure rating [bar]	Protection	Medium temperature oil [°C]	Ambient temperature [°C]	Drawing no.	Order no.
M12 connector · Output function 4...20 mA (can be configured); digital alarm output · Wiring diagram no. 1 · Connector groups 14, 15, 16, 17							



Minimes M16 x 2	420	IP 67	-10...80	-10...60	1	LDP100
-----------------	-----	-------	----------	----------	---	---------------



Oil moisture sensor

Type	Process connection	Pressure rating [bar]	Protection	Medium temperature oil [°C]	Ambient temperature [°C]	Drawing no.	Order no.
M12 connector · Output function 4...20 mA analogue · Wiring diagram no. 2 · Connector groups 15, 16, 17							



G 3/4	50	IP 67	-20...85	-20...85	2	LDH100
-------	----	-------	----------	----------	---	---------------

Accessories for LDP oil particle monitor

Type	Description	Order no.
	Screw couplings with cover plate · Blende 0.18 mm · Housing materials: socket housing: steel / surface characteristics: zinc/nickel grey / sealing: NBR	E43330
	Screw couplings with cover plate · Blende 0.3 mm · Housing materials: socket housing: steel / surface characteristics: zinc/nickel grey / sealing: NBR	E43331
	Jumper · straight / straight · CAN adapter cable: M12 plug, 5-pole / M12 socket, 8-pole · Gold-plated contacts · 0.15 m · Housing materials: PUR	E43332
	BasicDisplay · 2.8" colour display · 5 freely programmable backlit function keys · Navigation key for cursor function · CAN interface · Programming according to IEC 61131-3 · 8...32 V DC	CR0451

Accessories for oil moisture sensor LDH

Type	Description	Order no.
	Adapter block · D33 / G 3/4 · for oil moisture sensor LDH100 · Housing materials: aluminium	E43400

Wiring diagrams

1

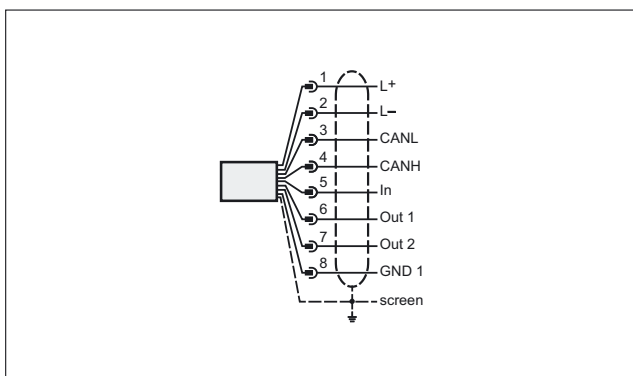

2

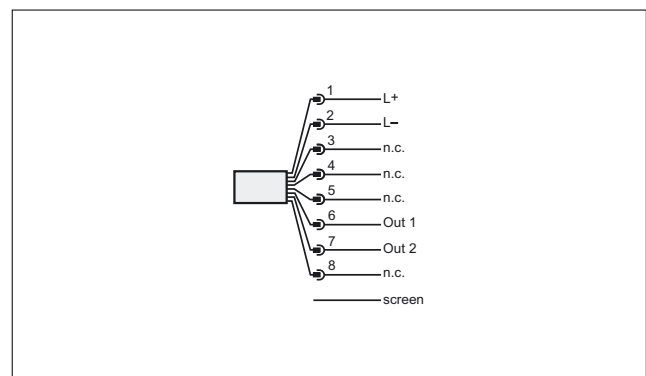

In: Switching input (low level activates measuring cycle), Out 1: Analogue output, Out 2: Switching output, GND 1: Signal ground Out 1



Condition monitoring systems

Scale drawings / drawing no. – CAD download: www.ifm.com

1

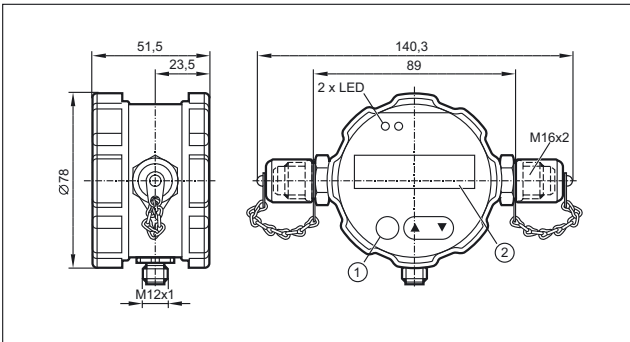

1: Programming buttons, 2: display

2

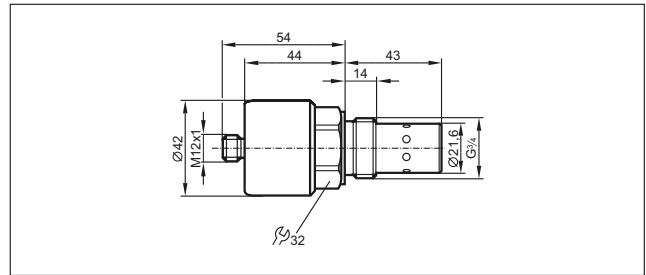





**Systems for
mobile machines**

Robust electronics for use in harsh environments



Control technology for mobile applications

Life today cannot be imagined without electronics in motor vehicles and mobile machines. Many necessary and convenient functions would be impossible without electronic systems. In contrast to electronics in consumer goods and „normal“ industrial applications such as packaging machines and conveyors, the requirements for components for mobile applications are much higher.

Electronic requirements

The extreme mechanical stress caused by impacts and shocks as well as operation at low and high ambient temperatures require careful selection of electronic components. The direct influence of dirt, humidity and water often cannot be excluded in field applications. Therefore, the devices require high protection rating and a special choice of materials.

In addition to mechanical and environmental influences, electrical interference affecting the whole system as well as individual devices must be taken into account. A wide supply voltage range and adapted protection measures allow reliable operation of the devices even in cases of large voltage fluctuations caused by the battery/generator system and high conducted interference. Strong conducted or radiated interference must not influence the function either.

For device networking, the CAN bus has become the successful standard in the last few years. For the large volume of car production, special, optimised and adapted protocols are used, whereas the CANopen protocol has become indispensable in mobile machines. Manufacturer-specific and industry-specific protocols such as diagnostic engine data according to SAE J 1939 can be coupled to the machine process via gateways.

	<i>Basic control systems</i>	698 - 703
	<i>Mobile controllers</i>	704 - 710
	<i>I/O modules</i>	712 - 717
	<i>Dialogue modules / displays</i>	718 - 721
	<i>Cameras</i>	722 - 727
	<i>Diagnostic and service units</i>	728 - 730
	<i>Signal converters</i>	732 - 733
	<i>Sensors</i>	734 - 751



Systems for mobile machines



Basic control systems





The ecomatmobile Basic control system has a modular design, is easy to install and to operate and is cost-optimised.

Besides pure control functions it provides solutions for wiring and protection.

In addition, a graphical visualisation module ensures the indication of system messages and simple display instruments.

System overview	Page
BasicController	698
Starter set ecomatmobile Basic	698
BasicRelay	699
BasicDisplay	699
BasicDisplay XL	699
Accessories for the mini control system Basic	699 - 702
Scale drawings / drawing no. – CAD download: www.ifm.com	702 - 703

BasicController

Type	Inputs / outputs total	Inputs	Outputs	Interfaces	Drawing no.	Order no.
Configurable input / output functions, Programming according to IEC 61131-3						
	20	12 x Digital 4 x analogue (U/I) 4 x frequency 4 x Resistor	8 x Digital 8 x PWM	2 x CAN	1	CR0401
	24	12 x Digital 4 x analogue (U/I) 4 x frequency 4 x Resistor	12 x Digital 2 x PWM-I 10 x PWM	2 x CAN	2	CR0403
	16	8 x Digital 4 x analogue (U/I) 4 x frequency 4 x Resistor	8 x Digital 8 x PWM-I 8 x PWM 4 x H bridge	2 x CAN	3	CR0411
	14	8 x Digital 4 x analogue (U/I) 4 x frequency 4 x Resistor	6 x Relay	2 x CAN	4	CR0431

Starter set ecomatmobile Basic

Type	Description	Order no.
	Starter set ecomatmobile Basic	EC0400

BasicRelay

Type	Inputs / outputs	Description	Drawing no.	Order no.
	-	BasicRelay · Locations for 6 automotive relays and 10 automotive fuses (6.3 mm) · 2 supply rails and 6 power distributors · freely wirable	5	CR0421



BasicDisplay

Type	Display	Operating elements	Inputs / outputs	Interfaces	Drawing no.	Order no.
5 freely programmable backlit function keys, Programming according to IEC 61131-3 · M12 connector						
	2.8" colour display 320 x 240 pixels	5 Pushbuttons 1 Navigation key for cursor function	-	1 x CAN	6	CR0451
	2.8" colour display 320 x 240 pixels	5 Pushbuttons 1 Navigation key for cursor function	-	1 x CAN	6	CR9221

BasicDisplay XL

Type	Display	Operating elements	Inputs / outputs	Interfaces	Drawing no.	Order no.
6 freely programmable backlit function keys, Programming according to IEC 61131-3 · M12 connector						
	4.3" colour display 480 x 272 pixels	6 Pushbuttons 1 Navigation key for cursor function	-	1 x CAN	7	CR0452
	4.3" colour display 480 x 272 pixels	6 Pushbuttons 1 Navigation key for cursor function	-	1 x CAN	7	CR9222



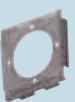







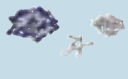



Accessories for the mini control system Basic

Type	Description	Order no.
	cover · for BasicController CR04xx and BasicRelay CR042x · incl. cable seal	EC0401
	cover · for BasicController CR04xx · Built-in display recess for BasicDisplay CR0451 · incl. cable seal	EC0402
	Mounting frame · for BasicDisplay CR0451 · panel · Housing materials: stainless steel	EC0403





Systems for mobile machines

Type	Description	Order no.
	Mounting frame · for BasicDisplay XL CR0452 · panel · Housing materials: stainless steel	EC0404
	RAM mount set · Ball size 1" (B) · e.g. for BasicDisplay · for use as a desktop unit · Housing materials: Mounting arm: aluminium black anodised / Mounting plate: aluminium black anodised / ball: rubber / Display carrier: plastics black	EC0405
	RAM mount set · Ball size 1" (B) · e.g. for BasicDisplay XL · for use as a desktop unit · Housing materials: Mounting arm: aluminium black anodised / Mounting plate: aluminium black anodised / ball: rubber / Display carrier: plastics black	EC0406
	Display carrier · RAM mount system · Ball size 1" (B) · e.g. for BasicDisplay · for use as a desktop unit · Housing materials: plastics black	EC0407
	Display carrier · RAM mount system · Ball size 1" (B) · e.g. for BasicDisplay XL · for use as a desktop unit · Housing materials: plastics black	EC0408
	Mounting plate · RAM mount system · Ball size 1" (B) · e.g. for BasicDisplay or BasicDisplay XL · for use as a desktop unit · Housing materials: Mounting plate: aluminium black anodised / ball: rubber	EC0409
	Mounting arm · 95 mm · RAM mount system · Ball size 1" (B) · e.g. for BasicDisplay or BasicDisplay XL · for use as a desktop unit · Housing materials: Mounting arm: aluminium black anodised	EC0410
	Socket · angled · Free from silicone · Free from halogen · Gold-plated contacts · M12 connector with integrated CAN terminating resistor (120 ohm) · 5 m · Housing materials: housing: TPU black / sealing: FKM	EVC492
	Jumper · wired · for 2 BasicControllers CR04xx · CAN interface · Power supply · 0.5 m	EC0451
	Jumper · wired · for 1 BasicController CR04xx and 1 BasicDisplay CR045x · CAN interface · Power supply · M12 connector · 0.1 m	EC0452
	Jumper · wired · for 2 BasicControllers CR04xx and 1 BasicDisplay CR045x · CAN interface · Power supply · M12 connector · 0.5 m	EC0453
	Jumper · wired · for 1 BasicController CR04xx and 1 BasicDisplay CR045x · CAN interface · Power supply · M12 connector · 5 m	EC0454
	Jumper · wired · for 1 BasicController CR04xx and 1 BasicDisplay CR045x · CAN interface · Power supply · M12 connector · 10 m	EC0458
	Jumper · wired · for 2 BasicControllers CR04xx and 1 BasicDisplay CR045x · CAN interface · Power supply · M12 connector · 5 m	EC0455
	Contacts and contact housings · for BasicController CR04xx · wirable · utilising all connections to a BasicController	EC0456

Type	Description	Order no.
	Set of contacts · for BasicRelay CR0421 · wirable · utilising all connections to a BasicRelay	EC0457
	Standard timer contact housing · for BasicController CR04xx · CAN1 and supply P/N1 · Coding · wirable · Housing materials: PA white	EC0460
	Standard timer contact housing · for BasicController CR04xx · CAN2 N2 · Coding · wirable · Housing materials: PA white	EC0461
	Standard timer contact housing · for BasicController CR04xx · Inputs A/B/C · Coding · wirable · Housing materials: PA grey	EC0462
	Standard timer contact housing · for BasicController CR04xx · Outputs D/E/F · Coding · wirable · Housing materials: PA white	EC0463
	Standard timer contact · for standard timer contact housing · 0.2...0.5 mm ² / Ø 1.0...1.6 mm · Housing materials: tin-plated	EC0459
	Standard timer contact · for standard timer contact housing · 0.5...1.0 mm ² / Ø 1.4...2.3 mm · Housing materials: tin-plated	EC0468
	Standard timer contact · for standard timer contact housing · 1.0...2.5 mm ² / Ø 2.1...3.1 mm · Housing materials: tin-plated	EC0469
	Standard power timer contact · for standard timer contact housing · 1.25...2.5 mm ² / Ø 2.1...3.1 mm · Housing materials: tin-plated	EC0470
	Contacts and contact housings · for BasicController relay CR0431 · wirable · utilising all connections to a BasicController relay	EC0464
	Connecting material for power supply · for BasicController relay CR0431 · wirable	EC0465
	Set of relays and fuses for 12 V DC systems · for BasicController relay CR0431	EC0466
	Set of relays and fuses for 24 V DC systems · for BasicController relay CR0431	EC0467
	CANfox · CAN/RS232-USB interface · Programming and diagnosis of CAN systems · 5 V DC (via USB interface)	EC2112
	Adapter cable · for CAN interface CANfox · CAN adapter: DIN connector, 6 poles / M12 connector, 5 poles · RS-232 adapter: DIN connector, 6 poles / Sub-D plug, 9 poles · Cable length 1 m	EC2113



Systems for mobile machines

Type	Description	Order no.
	Set of programming cables · for CAN interface CANfox · Cable BasicController: DIN connector, 6-pole / standard timer contact housing, 6-pole · Cable BasicDisplay: DIN connector, 6-pole / M12 socket, 5-pole · CAN interface · Voltage supply via individual wires with end ferrules · Cable length 1 m · 1 m	EC2114
	Programming software CODESYS · for configuration, programming and diagnosis of ifm controller systems · German version · incl. the DVD "Software, tools and documentation"	CP9006
	Programming software CODESYS · for configuration, programming and diagnosis of ifm controller systems · English version · incl. the DVD "Software, tools and documentation"	CP9008

Scale drawings / drawing no. – CAD download: www.ifm.com

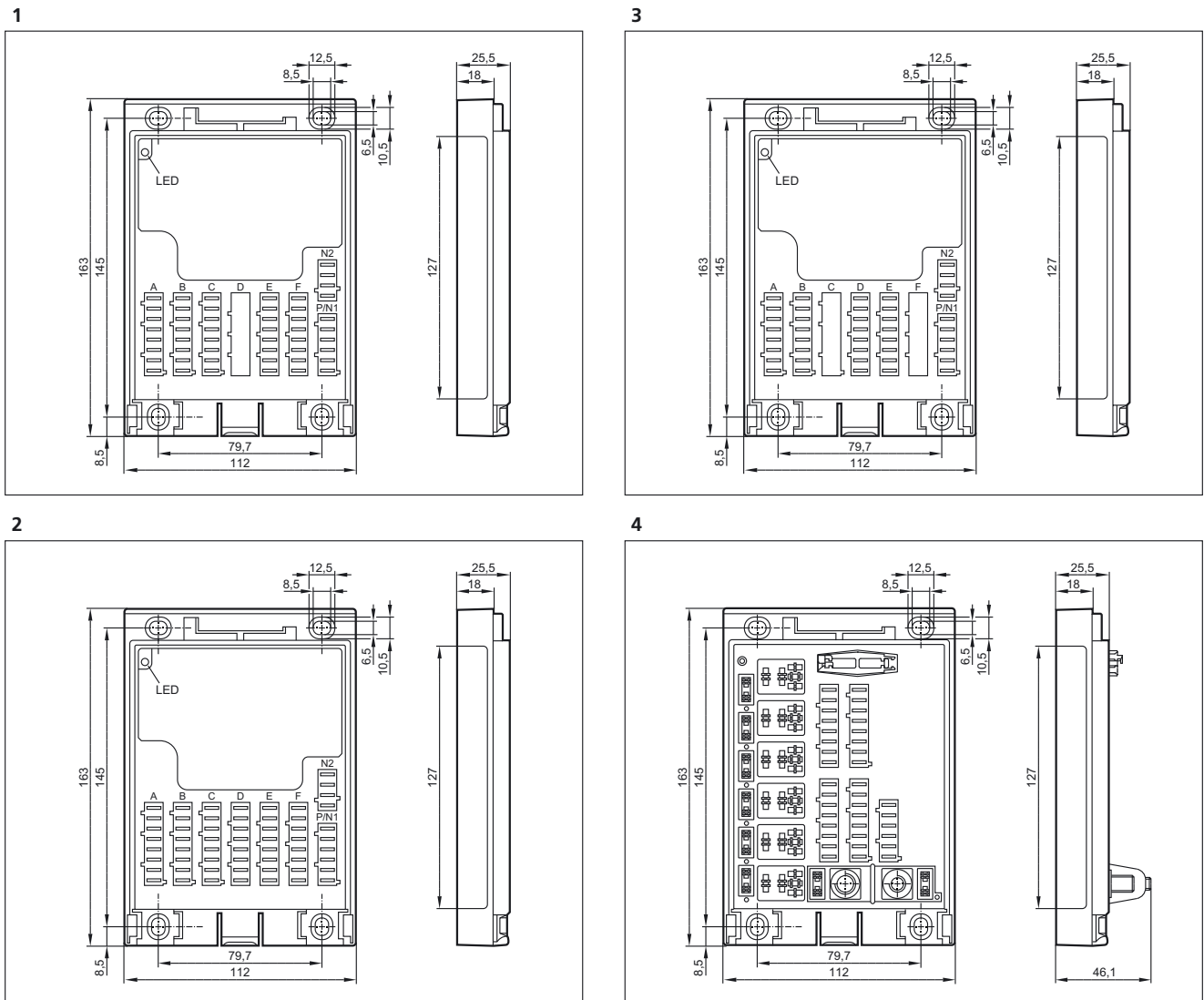

Scale drawings / drawing no. – CAD download: www.ifm.com

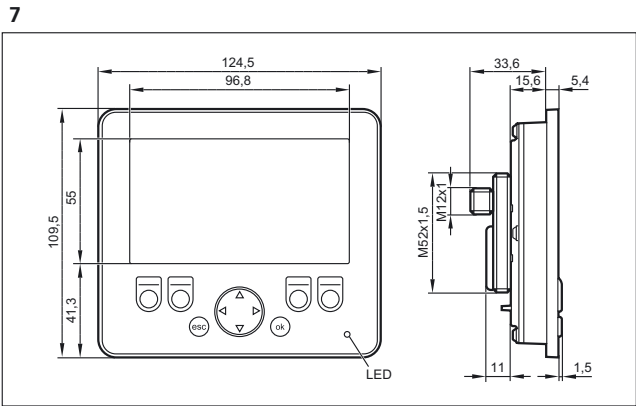
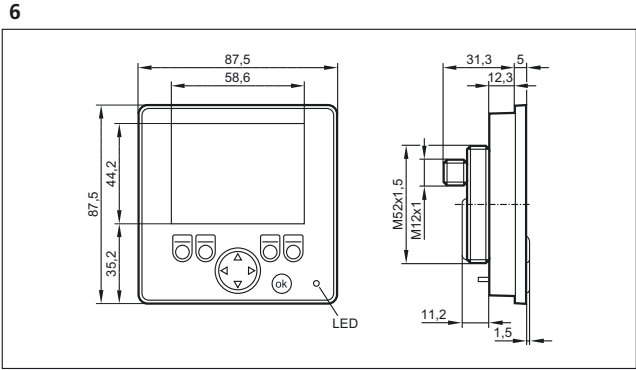
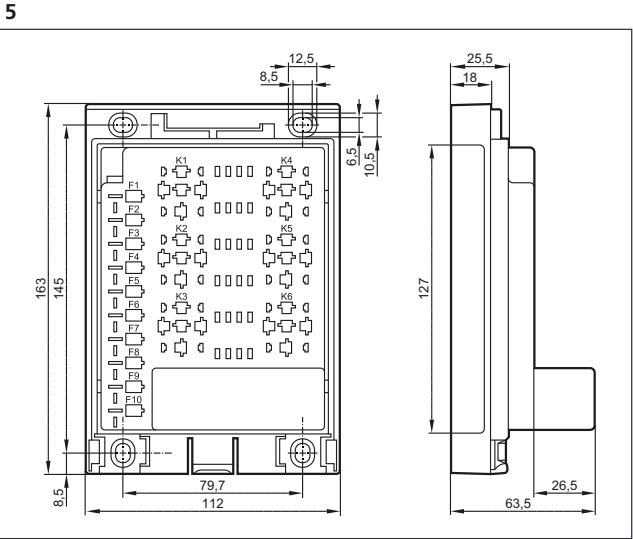



Systems for mobile machines



Mobile controllers

The platform of the ecomat*mobile* control system: the powerful controller family. Free programmability and the variety of configuration options enable use in a wide range of different applications.

System overview	Page
32 bit ecomatController	704
SmartController 32 bits	704 - 705
32-bit ClassicController	705
32-bit ExtendedController	705
32 bit ISOBUS controller	705 - 706
CabinetController for use in control cabinets	706
Connection technology for control systems	706
Accessories and software	707
Connection technology for control systems	707 - 708
Scale drawings / drawing no. – CAD download: www.ifm.com	709 - 710

32 bit ecomatController

Type	Inputs / outputs total	Inputs	Outputs	Interfaces	Drawing no.	Order no.
------	------------------------	--------	---------	------------	-------------	-----------

Configurable input / output functions, Programming according to IEC 61131-3

	60	32 x Digital 16 x analogue (U/I) 8 x frequency 4 x Resistor	27 x Digital 1 x analogue (0...10 V) 18 x PWM-I, 27 x PWM 3 x H bridge	4 x CAN 1 x Ethernet 1 x RS-232	1	CR7115
---	----	--	---	---------------------------------------	---	--------

SmartController 32 bits

Type	Inputs / outputs total	Inputs	Outputs	Interfaces	Drawing no.	Order no.
------	------------------------	--------	---------	------------	-------------	-----------

Configurable input / output functions, Programming according to IEC 61131-3

	32	16 x Digital 4 x analogue (U/I) 4 x frequency 2 x Resistor	16 x Digital 2 x analogue (0.2...10 V) 2 x PWM-I 12 x PWM	2 x CAN	2	CR2530
---	----	---	--	---------	---	--------

Type	Inputs / outputs total	Inputs	Outputs	Interfaces	Drawing no.	Order no.
------	------------------------	--------	---------	------------	-------------	-----------



Configurable input / output functions, Programming according to IEC 61131-3

	64	32 x Digital 8 x analogue (U/I) 8 x frequency 4 x Resistor	32 x Digital 4 x analogue (0.2...10 V) 4 x PWM-I 24 x PWM	3 x CAN	3	CR2532
---	----	---	--	---------	---	--------

32-bit ClassicController

Type	Inputs / outputs total	Inputs	Outputs	Interfaces	Drawing no.	Order no.
------	------------------------	--------	---------	------------	-------------	-----------



Configurable input / output functions, Programming according to IEC 61131-3

	32	16 x Digital 16 x analogue (U/I) 16 x frequency	16 x Digital 16 x PWM-I 16 x PWM 2 x H bridge	4 x CAN 1 x RS-232 1 x USB	4	CR0032
	32	16 x Digital 12 x analogue (U/I) 12 x frequency 4 x Resistor	16 x Digital 16 x PWM-I 16 x PWM 2 x H bridge	4 x CAN 1 x RS-232 1 x USB	5	CR0033
	64	32 x Digital 16 x analogue (U/I) 16 x frequency 6 x Resistor	32 x Digital 2 x analogue (0.2...10 V) 18 x PWM-I, 28 x PWM 2 x H bridge	5 x CAN 1 x RS-232 1 x USB	6	CR0133

32-bit ExtendedController

Type	Inputs / outputs total	Inputs	Outputs	Interfaces	Drawing no.	Order no.
------	------------------------	--------	---------	------------	-------------	-----------



Configurable input / output functions, Programming according to IEC 61131-3

	80	32 x Digital 32 x analogue (U/I) 32 x frequency	48 x Digital 32 x PWM-I 32 x PWM 4 x H bridge	2 x 2 x CAN 1 x RS-232 1 x USB	6	CR0234
	80	40 x Digital 36 x analogue (U/I) 36 x frequency 4 x Resistor	40 x Digital 32 x PWM-I 32 x PWM 4 x H bridge	2 x 2 x CAN 1 x RS-232 1 x USB	6	CR0235

32 bit ISOBUS controller





Type	Inputs / outputs total	Inputs	Outputs	Interfaces	Drawing no.	Order no.
------	------------------------	--------	---------	------------	-------------	-----------

Configurable input / output functions, Programming according to IEC 61131-3

	32	16 x Digital 12 x analogue (U/I) 12 x frequency 4 x Resistor	16 x Digital 16 x PWM-I 16 x PWM 2 x H bridge	4 x CAN 1 x RS-232 1 x USB	5	CR0053
	64	32 x Digital 16 x analogue (U/I) 16 x frequency 6 x Resistor	32 x Digital 2 x analogue (0.2...10 V) 18 x PWM-I, 28 x PWM 2 x H bridge	5 x CAN 1 x RS-232 1 x USB	6	CR0153







Systems for mobile machines

Type	Inputs / outputs total	Inputs	Outputs	Interfaces	Drawing no.	Order no.
Configurable input / output functions, Programming according to IEC 61131-3						
	80	40 x Digital 36 x analogue (U/I) 36 x frequency 4 x Resistor	40 x Digital 32 x PWM-I 32 x PWM 4 x H bridge	2 x 2 x CAN 1 x RS-232 1 x USB	6	CR0253
	32	16 x Digital 12 x analogue (U/I) 12 x frequency 4 x Resistor	16 x Digital 16 x PWM-I 16 x PWM 2 x H bridge	4 x CAN 1 x RS-232 1 x USB	5	CR0063
	64	32 x Digital 16 x analogue (U/I) 16 x frequency 6 x Resistor	32 x Digital 2 x analogue (0.2...10 V) 18 x PWM-I, 28 x PWM 2 x H bridge	5 x CAN 1 x RS-232 1 x USB	6	CR0163
	80	40 x Digital 36 x analogue (U/I) 36 x frequency 4 x Resistor	40 x Digital 32 x PWM-I 32 x PWM 4 x H bridge	2 x 2 x CAN 1 x RS-232 1 x USB	6	CR0263



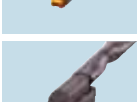

CabinetController for use in control cabinets

Type	Inputs / outputs total	Inputs	Outputs	Interfaces	Drawing no.	Order no.
Configurable input / output functions, Programming according to IEC 61131-3						
	42	24 x Digital 8 x analogue (U/I) 4 x frequency	18 x Digital 8 x PWM 6 x PNP 10 A	2 x CAN 1 x RS-232	7	CR0303





Connection technology for control systems

Type	Description	Order no.
	Cable with connector · AMP 81-pole · B-coded · 47 cores · wired · Cable length 2.5 m	EC0720
	Cable with connector · AMP 81-pole · A-coded · 58 cores · wired · Cable length 2.5 m	EC0710
	Cable with connector · AMP 81-pole · B-coded · 73 cores · wired · Cable length 2.5 m	EC0721
	Cable with connector · AMP 81-pole · A-coded · 81 cores · wired · Cable length 2.5 m	EC0711
	Connector AMP 81-pole · A-coded · wirable · with contacts (Junior Power Timer)	EC0701
	Connector AMP 81-pole · B-coded · wirable · with contacts (Junior Power Timer)	EC0702

Accessories and software

Type	Description	Order no.
	Programming software CODESYS · for configuration, programming and diagnosis of ifm controller systems · German version · incl. the DVD "Software, tools and documentation"	CP9006
	Programming software CODESYS · for configuration, programming and diagnosis of ifm controller systems · English version · incl. the DVD "Software, tools and documentation"	CP9008
	Maintenance for PC with WINDOWS or LINUX operating system · USB stick	CP9030
	Maintenance for ifm displays with LINUX · USB stick	CP9031
	System Startup Virtual Terminal Client · USB stick · for ClassicController ISOBUS	CP9200
	System Startup TaskController Client · USB stick · for mobile controllers	CP9201

Connection technology for control systems

Type	Description	Order no.
	Connector AMP 55-pole · wirable · with contacts (Junior Power Timer)	EC2013
	Cable with connector · AMP 55-pole · wired · Cable length 1.2 m · Cores sealed individually · Core cross-section 1 mm ²	EC2084
	Cable with connector · AMP 55-pole · wired · Cable length 2.5 m · Cores sealed individually · Core cross-section 1 mm ²	EC2097
	Cable with connector · AMP 55-pole · wired · Cable length 1.2 m · Core cross-section 1 mm ²	EC2086
	Cable with connector · AMP 55-pole · wired · Cable length 2.5 m · Core cross-section 1 mm ²	EC2046
	Cable with connector · AMP 6-pole · wired · fully wired · Cable length 1.2 m · Core cross-section 1 mm ²	EC1520
	Cable with connector · AMP 10-pole · wired · fully wired · Cable length 1.2 m · Core cross-section 1 mm ²	EC1521



Systems for mobile machines

Type	Description	Order no.
	Cable with connector · AMP 14-pole · wired · fully wired · Cable length 1.2 m · Core cross-section 1 mm ²	EC1522
	Cable with connector · AMP 18-pole · wired · fully wired · Cable length 1.2 m · Core cross-section 1 mm ²	EC1523
	Cable with connector · AMP 18-pole · wired · partially wired · for input signals · Cable length 1.2 m · Core cross-section 1 mm ²	EC1524
	Cable with connector · AMP 18-pole · wired · fully wired · Cable length 2.5 m · Core cross-section 1 mm ²	EC1533
	Plug set for CabinetModule CR2012 / CR2014 · wirable · consisting of: · AMP Crimp housing 1 x 6 pins, 2 x 18 pins incl. Crimp contacts (Junior Power Timer)	EC2053
	Plug set for CabinetController CR0301 / CR0302 · wirable · consisting of: · AMP Crimp housing 1 x 6 pins, 2 x 10 pins, 3 x 18 pins incl. Crimp contacts (Junior Power Timer)	EC2075
	Plug set for CabinetModule CR201x · wirable · consisting of: · AMP Crimp housing 1 x 6 pins, 2 x 14 pins, 2 x 18 pins incl. Crimp contacts (Junior Power Timer)	EC2089
	Plug set · wirable · consisting of: · AMP Crimp housing 2 x 6 pins, 2 x 10 pins, 3 x 18 pins incl. Crimp contacts (Junior Power Timer)	EC2090
	RS-232 Programming adapter · with gender changer for pin-socket conversion	EC2076
	programming cable · cable length 2 m interface 9-pole D-SUB (female) · AMP 6-pole · Test input (AMP connector, pin 5) connected to VBB via link	EC2091
	programming cable · e.g. for ClassicController CR0032 or ExtendedController CR0232 · wired	EC2096
	Load-Dump-Module · 12 V DC	EC2015
	Load-Dump-Module · 24 V DC	EC2016
	Spring terminal box · e.g. for starter set	EC2032

Scale drawings / drawing no. – CAD download: www.ifm.com

1

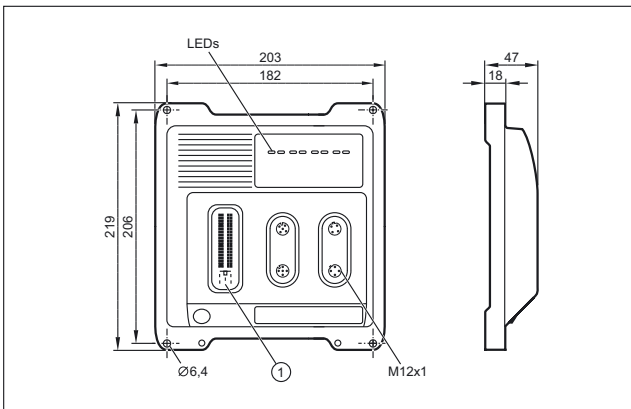

1: Connector AMP 81-pole, A-coded

2

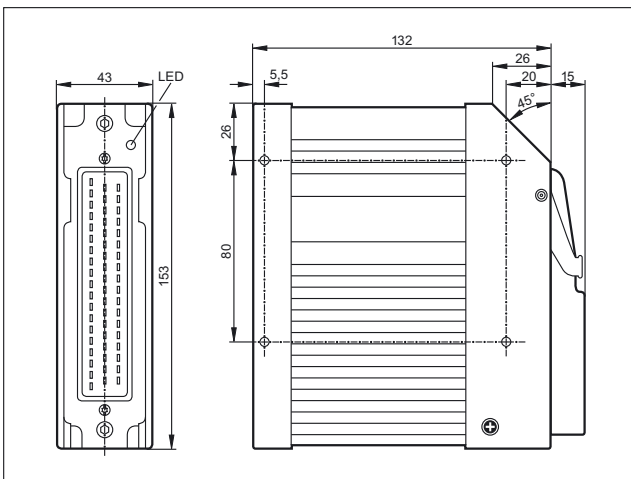

3

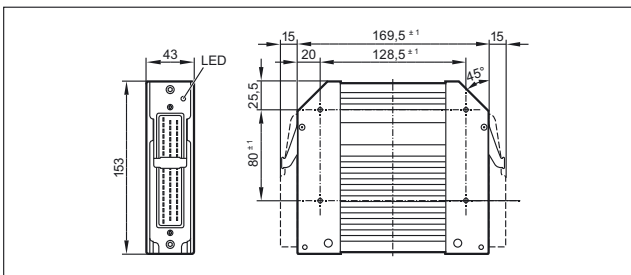

4

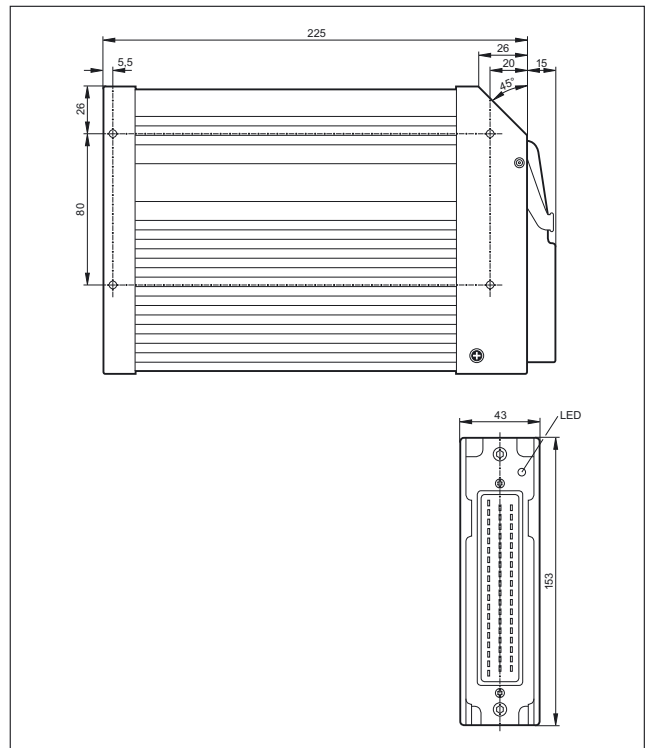

5

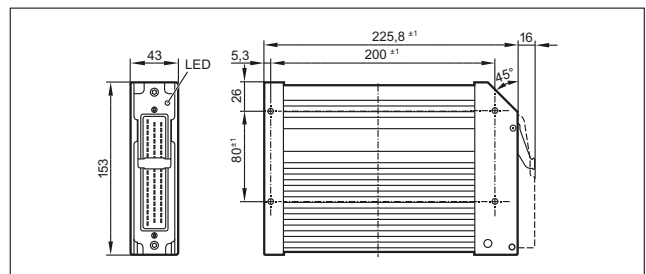

6

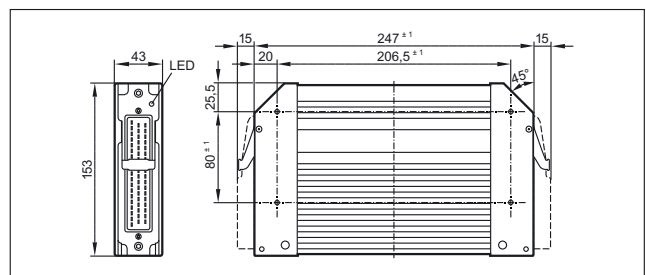



**Systems for
mobile machines**

Scale drawings / drawing no. – CAD download: www.ifm.com

7

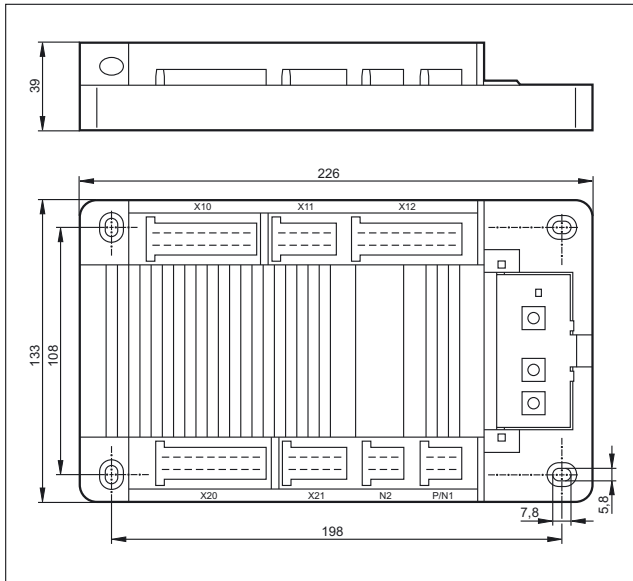





Systems for mobile machines





I/O modules

Decentralised I/O modules for use in CANopen bus systems. Considerably reduced wiring, they are mounted where the signals are generated.

The flexible configuration of the inputs and outputs enables universal use and reduces the costs for stockholding.

System overview	Page
ioControl	712
CompactModules metal	713
SmartModules	713
CabinetModules	713
Accessories for I/O modules	713 - 716
Scale drawings / drawing no. – CAD download: www.ifm.com	717

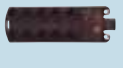
ioControl

Type	Inputs / outputs total	Inputs	Outputs	Interfaces	Drawing no.	Order no.
Programming according to IEC 61131-3 · DEUTSCH connector						
	16	16 x Digital 8 x analogue (U/I) 4 x frequency 4 x Resistor	–	2 x CAN	1	CR2050
Configurable output functions, Programming according to IEC 61131-3 · DEUTSCH connector						
	16	–	16 x Digital 8 x PWM-I 16 x PWM	2 x CAN	1	CR2051
Configurable input / output functions, Programming according to IEC 61131-3 · DEUTSCH connector						
	16	8 x Digital 4 x analogue (U/I) 4 x frequency 4 x Resistor	8 x Digital 8 x PWM-I 8 x PWM	2 x CAN	1	CR2052

CompactModules metal

Type	Inputs / outputs total	Inputs	Outputs	Interfaces	Drawing no.	Order no.
------	------------------------	--------	---------	------------	-------------	-----------

CAN parameters adjustable via coding switch, Configurable input / output functions · M12 connector

	8	–	8 x Digital 4 x PWM-I 4 x PWM	1 x CAN	2	CR2031
	16	8 x Digital 4 x analogue (U/I)	8 x Digital 4 x PWM	1 x CAN	3	CR2032
	12	8 x Digital 4 x analogue (U/I)	4 x Digital 4 x PWM	1 x CAN	4	CR2033

SmartModules

Type	Inputs / outputs total	Inputs	Outputs	Interfaces	Drawing no.	Order no.
------	------------------------	--------	---------	------------	-------------	-----------



Configurable input / output functions · 55-pole connec.

	30	15 x Digital 4 x analogue (U/I)	15 x Digital 3 x PWM 4 x PNP 10 A 4 x H bridge	1 x CAN	5	CR2520
---	----	------------------------------------	---	---------	---	--------

CabinetModules

Type	Inputs / outputs total	Inputs	Outputs	Interfaces	Drawing no.	Order no.
------	------------------------	--------	---------	------------	-------------	-----------

CAN parameters adjustable via coding switch, Configurable input / output functions · Connector





	16	16 x Digital 4 x analogue (0...10 V)	4 x Digital 2 x PWM	1 x CAN	6	CR2012
	16	16 x Digital 4 x analogue (0...5 V)	4 x Digital 2 x PWM	1 x CAN	6	CR2014
	32	16 x Digital 4 x analogue (U/I) 4 x frequency	16 x Digital 4 x PWM	1 x CAN	7	CR2016











Accessories for I/O modules

Type	Description	Order no.
	label tag · 20 x 9 mm · Housing materials: plastics white	E70424





Systems for mobile machines

Type	Description	Order no.
	Protective cap · M12 · for M12 sockets of CompactModule Metal · Housing materials: PA black	EC2098
	Connector AMP 55-pole · wirable · with contacts (Junior Power Timer)	EC2013
	Cable with connector · AMP 55-pole · wired · Cable length 1.2 m · Cores sealed individually · Core cross-section 1 mm ²	EC2084
	Cable with connector · AMP 55-pole · wired · Cable length 2.5 m · Cores sealed individually · Core cross-section 1 mm ²	EC2097
	Cable with connector · AMP 55-pole · wired · Cable length 1.2 m · Core cross-section 1 mm ²	EC2086
	Cable with connector · AMP 55-pole · wired · Cable length 2.5 m · Core cross-section 1 mm ²	EC2046
	Plug set for CabinetModule CR2012 / CR2014 · wirable · consisting of: · AMP Crimp housing 1 x 6 pins, 2 x 18 pins incl. Crimp contacts (Junior Power Timer)	EC2053
	Plug set for CabinetModule CR201x · wirable · consisting of: · AMP Crimp housing 1 x 6 pins, 2 x 14 pins, 2 x 18 pins incl. Crimp contacts (Junior Power Timer)	EC2089
	Plug set · wirable · consisting of: · AMP Crimp housing 2 x 6 pins, 2 x 10 pins, 3 x 18 pins incl. Crimp contacts (Junior Power Timer)	EC2090
	Cable with connector · AMP 6-pole · wired · fully wired · Cable length 1.2 m · Core cross-section 1 mm ²	EC1520
	Cable with connector · AMP 10-pole · wired · fully wired · Cable length 1.2 m · Core cross-section 1 mm ²	EC1521
	Cable with connector · AMP 14-pole · wired · fully wired · Cable length 1.2 m · Core cross-section 1 mm ²	EC1522
	Cable with connector · AMP 18-pole · wired · fully wired · Cable length 1.2 m · Core cross-section 1 mm ²	EC1523
	Cable with connector · AMP 18-pole · wired · partially wired · for input signals · Cable length 1.2 m · Core cross-section 1 mm ²	EC1524
	Cable with connector · AMP 18-pole · wired · fully wired · Cable length 2.5 m · Core cross-section 1 mm ²	EC1533

Type	Description	Order no.
	Socket · straight · Free from halogen · Gold-plated contacts · M12 connector · 2 m · 5-pole · Housing materials: PUR	E11596
	Socket · straight · Free from halogen · Gold-plated contacts · M12 connector · 5 m · 5-pole · Housing materials: PUR	E11597
	Terminating resistor socket · straight · Gold-plated contacts · M12 connector · 5-pole · Housing materials: TPU	E11589
	Terminating resistor plug · straight · Gold-plated contacts · M12 connector · 5-pole · Housing materials: TPU	E11590
	Cable plug · straight · Free from halogen · Gold-plated contacts · M12 connector · 2 m · 5-pole · Housing materials: PUR	E11598
	Cable plug · straight · Free from halogen · Gold-plated contacts · M12 connector · 5 m · 5-pole · Housing materials: PUR	E11599
	Jumper · straight / straight · Free from halogen · Gold-plated contacts · 0.3 m · 5-pole · Housing materials: PUR	E11591
	Jumper · straight / straight · Free from halogen · Gold-plated contacts · 1 m · 5-pole · Housing materials: PUR	E11592
	Jumper · straight / straight · Free from halogen · Gold-plated contacts · 2 m · 5-pole · Housing materials: PUR	E11593
	Jumper · straight / straight · Free from halogen · Gold-plated contacts · 5 m · 5-pole · Housing materials: PUR	E11594
	Socket · angled · Free from silicone · Free from halogen · Gold-plated contacts · M12 connector with integrated CAN terminating resistor (120 ohm) · 5 m · 5-pole · Housing materials: housing: TPU black / sealing: Viton	EVC492
	Cable plug · angled · Free from silicone · Free from halogen · Gold-plated contacts · M12 connector · 6 m · 5-pole · Housing materials: housing: TPU black	E12215
	Wirable plug · straight · Free from silicone · Free from halogen · wirable · Gold-plated contacts · M12 connector · 5-pole · Housing materials: PA	E11506
	Wirable socket · straight · Free from silicone · Free from halogen · wirable · Gold-plated contacts · M12 connector · 5-pole · Housing materials: PA	E11511
	Wirable plug · straight · Free from silicone · Free from halogen · wirable · Gold-plated contacts · M12 connector · 4-pole · Housing materials: PA	E11504



Systems for mobile machines

Type	Description	Order no.
	Wirable plug · angled · Free from silicone · Free from halogen · wirable · Gold-plated contacts · M12 connector · 4-pole · Housing materials: PA	E11505
	Wirable plug · angled · Free from silicone · Free from halogen · wirable · Gold-plated contacts · M12 connector · 5-pole · Housing materials: PA	E11860
	Wirable plug · angled · Free from silicone · Free from halogen · wirable · Gold-plated contacts · M12 connector · 5-pole · Housing materials: PA	E11507
	Load-Dump-Module · 12 V DC	EC2015
	Load-Dump-Module · 24 V DC	EC2016
	Plug for Danfoss PWM valves · wirable · terminals	EC2056
	Plug for Danfoss PWM valves · M12 connector	EC2088
	Adapter cable for CAN devices with M12 connector (5 pole) · e.g. CANmem, CANremote or inclination sensors	EC2062

Scale drawings / drawing no. – CAD download: www.ifm.com

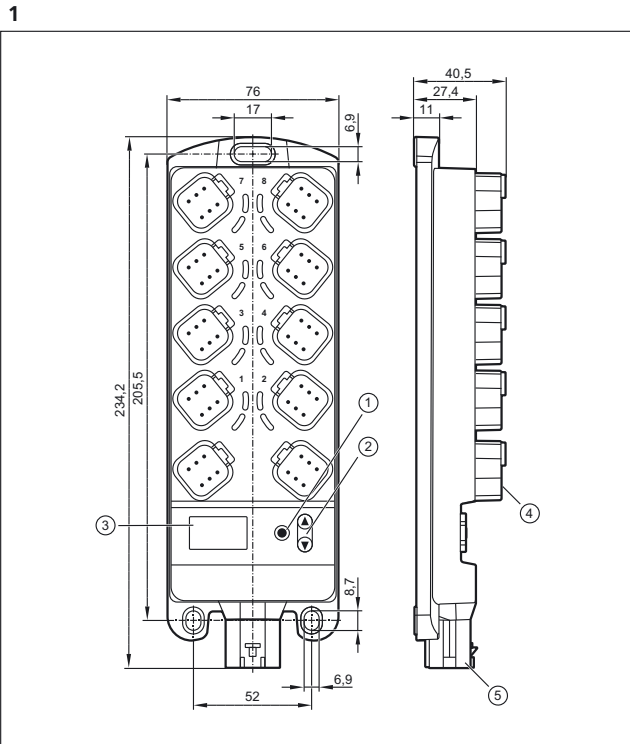

1+2: Programming buttons, 3: 4-digit 10-segment display, 4: DEUTSCH connector, 5: AMP plug

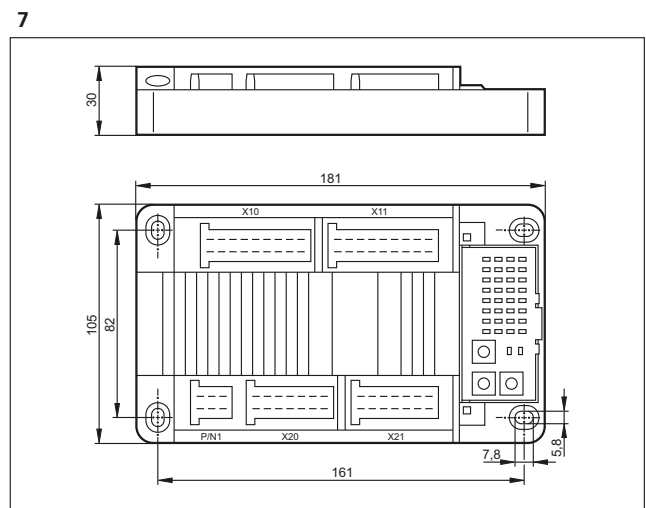
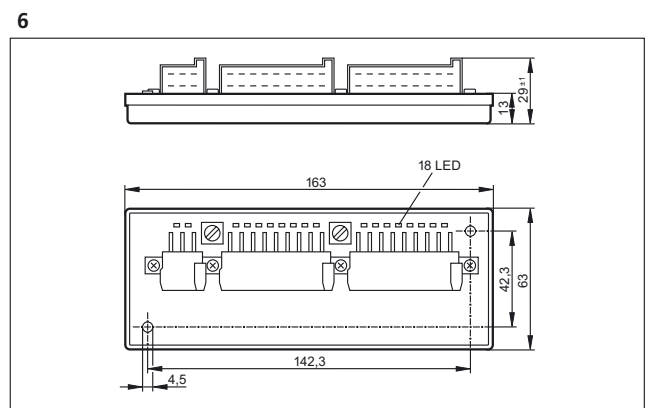
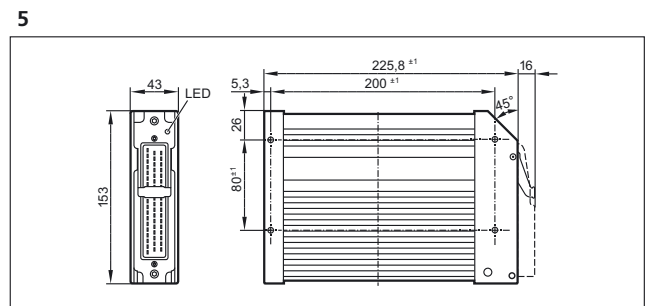
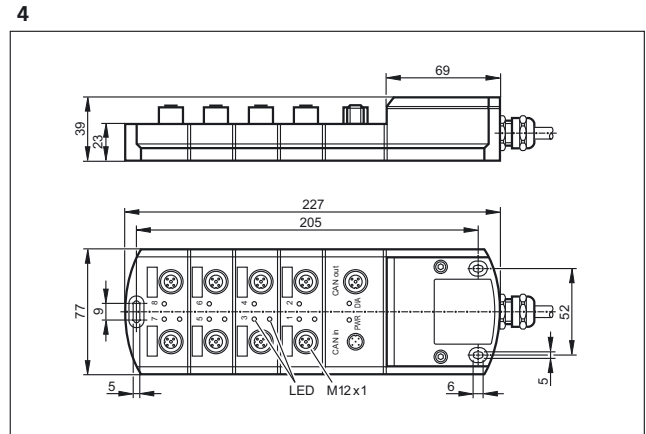
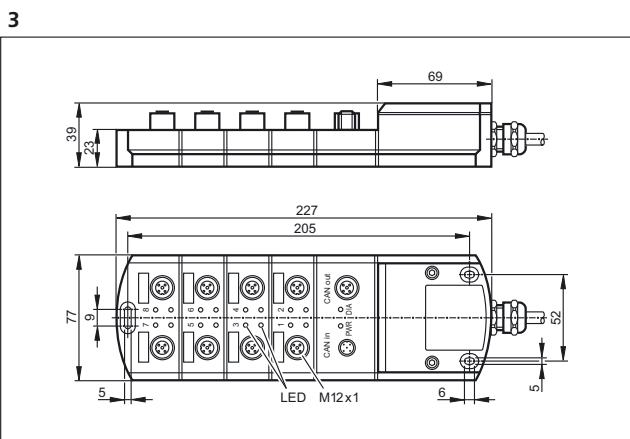
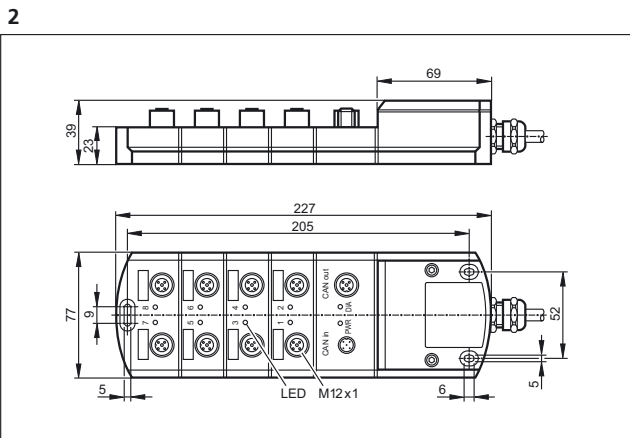



Systems for mobile machines







Dialogue modules / displays



Displays with graphics capabilities, free programming to IEC 61131 and various interfaces are features of the dialogue modules.

The convenient user interface for service and machine handling – the dialogue modules of the ecomatmobile control system.



System overview	Page
PDM360 NG with 7" display	718 - 719
PDM360 NG with 7" display, optical bonding	719
PDM360 NG with 12" display	719 - 720
Accessories for displays	720
Connection technology for displays	721
Scale drawings / drawing no. – CAD download: www.ifm.com	721

PDM360 NG with 7" display

Type	Display	Operating elements	Inputs / outputs	Interfaces	Drawing no.	Order no.
Real-time clock, 8 freely programmable backlit function keys, Programming according to IEC 61131-3 · M12 connector						
	7" colour display 800 x 480 pixels	8 Pushbuttons	1 x digital in 1 x analogue in 1 x digital out 2 x Video (CVBS) 1 x Buzzer	4 x CAN 1 x Ethernet 2 x USB	1	CR1083
	7" colour display 800 x 480 pixels	8 Pushbuttons	1 x digital in 1 x analogue in 1 x digital out 1 x Buzzer Real-time clock	4 x CAN 1 x Ethernet 2 x USB	1	CR1087
Real-time clock, 9 freely programmable backlit function keys, Programming according to IEC 61131-3 · M12 connector						
	7" colour display 800 x 480 pixels	9 Pushbuttons 1 Encoder with pushbutton	1 x digital in 1 x analogue in 1 x digital out 1 x Buzzer Real-time clock	4 x CAN 1 x Ethernet 2 x USB	2	CR1080
	7" colour display 800 x 480 pixels	9 Pushbuttons 1 Navigation key with pushbutton	1 x digital in 1 x analogue in 1 x digital out 1 x Buzzer Real-time clock	4 x CAN 1 x Ethernet 2 x USB	3	CR1081
	7" colour display 800 x 480 pixels	9 Pushbuttons 1 Navigation key with pushbutton 1 Touch screen	1 x digital in 1 x analogue in 1 x digital out 2 x Video (CVBS) 1 x Buzzer	4 x CAN 1 x Ethernet 2 x USB	3	CR1082

Type	Display	Operating elements	Inputs / outputs	Interfaces	Draw- ing no.	Order no.
Real-time clock, 9 freely programmable backlit function keys, Programming according to IEC 61131-3 · M12 connector						
	7" colour display 800 x 480 pixels	9 Pushbuttons 1 Encoder with pushbutton	1 x digital in 1 x analogue in 1 x digital out 2 x Video (CVBS) 1 x Buzzer	4 x CAN 1 x Ethernet 2 x USB	2	CR1084
	7" colour display 800 x 480 pixels	9 Pushbuttons 1 Navigation key with pushbutton	1 x digital in 1 x analogue in 1 x digital out 2 x Video (CVBS) 1 x Buzzer	4 x CAN 1 x Ethernet 2 x USB	3	CR1085



PDM360 NG with 7" display, optical bonding

Type	Display	Operating elements	Inputs / outputs	Interfaces	Draw- ing no.	Order no.
Real-time clock, 9 freely programmable backlit function keys, Programming according to IEC 61131-3 · M12 connector						
	7" colour display 800 x 480 pixels	9 Pushbuttons 1 Encoder with pushbutton	1 x digital in 1 x analogue in 1 x digital out 1 x Buzzer Real-time clock	4 x CAN 1 x Ethernet 2 x USB	2	CR9223
	7" colour display 800 x 480 pixels	9 Pushbuttons 1 Navigation key with pushbutton	1 x digital in 1 x analogue in 1 x digital out 1 x Buzzer Real-time clock	4 x CAN 1 x Ethernet 2 x USB	3	CR9224

Real-time clock, 8 freely programmable backlit function keys, Programming according to IEC 61131-3 · M12 connector

	7" colour display 800 x 480 pixels	8 Pushbuttons	1 x digital in 1 x analogue in 1 x digital out 2 x Video (CVBS) 1 x Buzzer	4 x CAN 1 x Ethernet 2 x USB	1	CR9225
---	---------------------------------------	---------------	--	------------------------------------	---	--------

Real-time clock, 9 freely programmable backlit function keys, Programming according to IEC 61131-3 · M12 connector

	7" colour display 800 x 480 pixels	9 Pushbuttons 1 Encoder with pushbutton	1 x digital in 1 x analogue in 1 x digital out 2 x Video (CVBS) 1 x Buzzer	4 x CAN 1 x Ethernet 2 x USB	2	CR9226
	7" colour display 800 x 480 pixels	9 Pushbuttons 1 Navigation key with pushbutton	1 x digital in 1 x analogue in 1 x digital out 2 x Video (CVBS) 1 x Buzzer	4 x CAN 1 x Ethernet 2 x USB	3	CR9227

PDM360 NG with 12" display









Type	Display	Operating elements	Inputs / outputs	Interfaces	Draw- ing no.	Order no.
Real-time clock, Programming according to IEC 61131-3 · M12 connector						
	12" colour display 1024 x 768 pixels	13 Pushbuttons 1 Navigation key with pushbutton	1 x digital in 1 x analogue in 1 x digital out 2 x Video (CVBS) 1 x Buzzer	4 x CAN 1 x Ethernet 2 x USB	4	CR1200



Systems for mobile machines

Type	Display	Operating elements	Inputs / outputs	Interfaces	Drawing no.	Order no.
Real-time clock, Programming according to IEC 61131-3 · M12 connector						
	12" colour display 1024 x 768 pixels	13 Pushbuttons 1 Navigation key with pushbutton 1 Touch screen	1 x digital in 1 x analogue in 1 x digital out 2 x Video (CVBS) 1 x Buzzer	4 x CAN 1 x Ethernet 2 x USB	4	CR1201

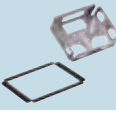
Accessories for displays

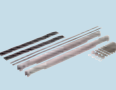
Type	Description	Order no.
	Mounting plate · RAM mount system · Ball size 1.5" (C) · e.g. for process and dialogue monitors PDM360 NG, PDM360, PDM360 compact or PDM360 smart · for use as a desktop unit	EC1410
	Mounting arm short · 90 mm · RAM mount system · Ball size 1.5" (C) · e.g. for process and dialogue monitors PDM360 NG, PDM360, PDM360 compact or PDM360 smart · for use as a desktop unit	EC1411
	Mounting arm standard · 144 mm · RAM mount system · Ball size 1.5" (C) · e.g. for process and dialogue monitors PDM360 NG, PDM360, PDM360 compact or PDM360 smart · for use as a desktop unit	EC1412
	Mounting arm long · 231 mm · RAM mount system · Ball size 1.5" (C) · e.g. for process and dialogue monitors PDM360 NG, PDM360, PDM360 compact or PDM360 smart · for use as a desktop unit	EC1413
	RAM mount set 1 · 144 mm · RAM mount system · Ball size 1.5" (C) · e.g. for process and dialogue monitors PDM360 NG, PDM360, PDM360 compact or PDM360 smart · for use as a desktop unit	EC1414
	Load-Dump-Module · 12 V DC	EC2015
	Load-Dump-Module · 24 V DC	EC2016
	Mounting frame and vibration absorber · for process and dialogue modules PDM360 NG · panel · Housing materials: steel sheet	EC2110
	Seal and vibration absorber · for process and dialogue modules PDM360 NG · panel · Housing materials: TPE black	EC2115
	Installation kit · for process and dialogue modules PDM360 NG-12 · panel · Housing materials: steel sheet	EC2117

Connection technology for displays

Type	Description	Order no.
	Wireable plug · straight · shieldable · Free from silicone · Free from halogen · wireable · Gold-plated contacts · B-coded · M12 connector · Housing materials: diecast zinc nickel-plated	E12355
	Jumper · for process and dialogue modules PDM360 NG · USB socket for installation in control panel or dashboard · 1.5 m	EC2099
	Jumper · straight / straight · Ethernet · Cross-over patch cable · 2 m · Housing materials: PUR / PC	E11898

Scale drawings / drawing no. – CAD download: www.ifm.com

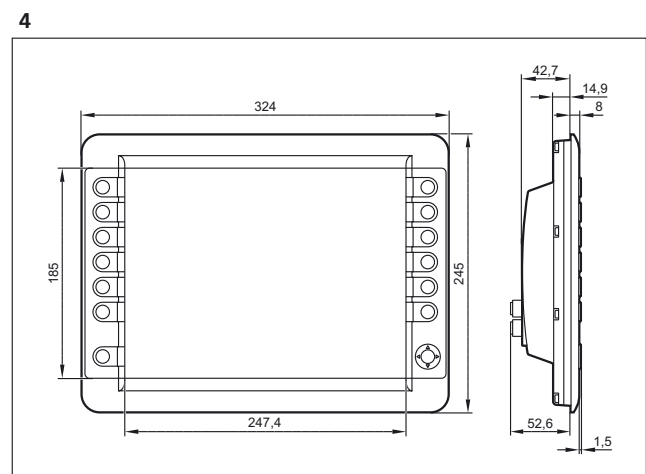
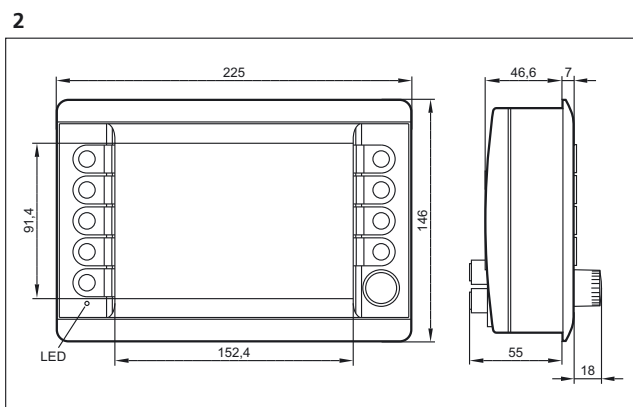
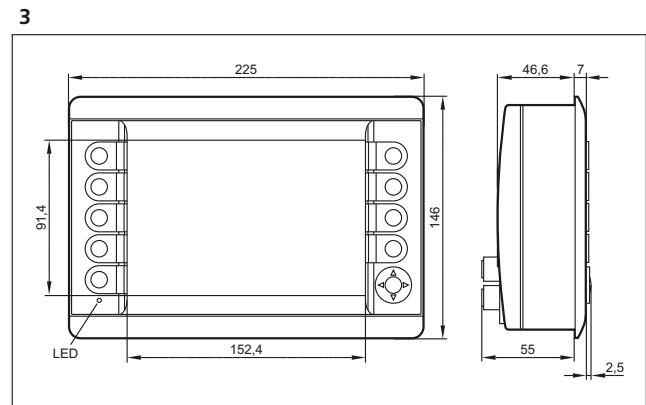
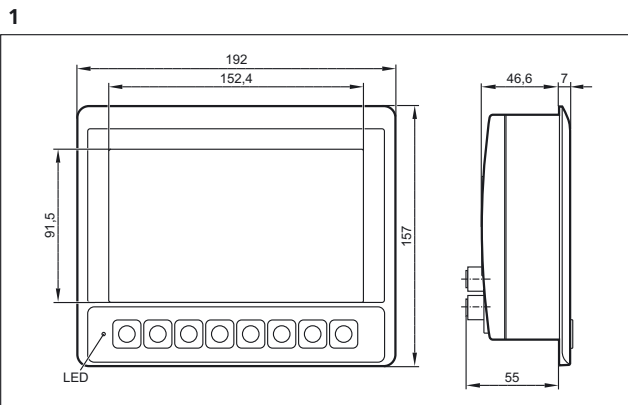



Systems for mobile machines







Cameras







In almost all mobile machines, users today use displays for indicating machine information. At the same time camera systems monitor the operating areas. Here, the new camera system O2M is used. Designed for extreme operating conditions.

System overview	Page
3D sensors for mobile machines	722
Accessories	723
Connection cables for industrial imaging	723 - 724
Camera systems for PDM360 color and PDM360 NG	724
Connection technology for displays	725
Accessories	725
Connection technology for displays	726
Scale drawings / drawing no. – CAD download: www.ifm.com	726 - 727



3D sensors for mobile machines

Type	Image resolution	Angle of aperture [°]	Additional functions	Interfaces	Draw- ing no.	Order no.
M12 connector						
	64 x 16 pixels	70 x 23	CAN output	Video signal analogue	1	O3M151
	64 x 16 pixels	95 x 32	CAN output	Video signal analogue	2	O3M161
	640 x 480 pixels	90	CAN output	Video signal analogue	3	O3M251
	720 x 576 pixels	120	CAN output	Video signal analogue	4	O3M261

Accessories







Type	Description	Order no.
	IR illumination unit · Device interfaces: MCI · Angle of aperture 70° x 23° (horizontal x vertical) · IR illumination unit for the operation of O3M15x and O3M25x · Connector · Housing materials: diecast aluminium	O3M950
	IR illumination unit · Device interfaces: MCI · Angle of aperture 95° x 32° (horizontal x vertical) · IR illumination unit for the operation of O3M16x and O3M26x · Connector · Housing materials: diecast aluminium	O3M960
	CANfox · CAN/RS232-USB interface · Programming and diagnosis of CAN systems · 5 V DC (via USB interface)	EC2112
	Set of programming cables · for CAN interface CANfox · Cable BasicController: DIN connector, 6-pole / standard timer contact housing, 6-pole · Cable BasicDisplay: DIN connector, 6-pole / M12 socket, 5-pole · CAN interface · Voltage supply via individual wires with end ferrules · Cable length 1 m	EC2114
	Operating software · O3Mxxx · O3D3xx	E3D300
	Mounting set · O3M · U-shaped fixture, adjustable · screw mounting onto common aluminium profiles and machine panels · Housing materials: fixture: stainless steel	E3M100
	Weather protection · O3M · mounting via screws · Housing materials: stainless steel black	E3M101
	Mounting set · O3M · U-shaped fixture, adjustable · screw mounting onto common aluminium profiles and machine panels · Housing materials: fixture: stainless steel black	E3M102
	Mounting set · O3M · Clamp mounting · rod mounting Ø 14 mm · Housing materials: fixture: stainless steel / clamp: stainless steel	E3M103

Connection cables for industrial imaging

Type	Description	Order no.
	Jumper · Connector · Connection between mobile 3D camera / sensor and illumination unit · 0.25 m	E3M120
	Jumper · Connector · Connection between mobile 3D camera / sensor and illumination unit · 1 m	E3M121
	Jumper · Connector · Connection between mobile 3D camera / sensor and illumination unit · 2 m	E3M122
	Jumper · Connector · Connection between mobile 3D camera / sensor and illumination unit · 3 m	E3M123



Systems for mobile machines

Type	Description	Order no.
	Socket · straight · M12 connector · Gold-plated contacts · Power supply for illumination unit · 2 m · Housing materials: PUR	E3M131
	Socket · straight · M12 connector · Gold-plated contacts · Power supply for illumination unit · 5 m · Housing materials: PUR	E3M132
	Socket · straight · M12 connector · Gold-plated contacts · Power supply for illumination unit · 10 m · Housing materials: PUR	E3M133
	Jumper · straight / angled · Connector · For mobile 3D Smart sensor with analogue PAL video output · M12 connector · 5 m · for type O3M · Housing materials: housing: PUR / sealing: FKM / Contact pins: CuSn6 surface nickel and tin-plated	E3M151
	Jumper · straight / angled · Connector · For mobile 3D Smart sensor with analogue PAL video output · M12 connector · 11 m · for type O3M · Housing materials: housing: PUR / sealing: FKM / Contact pins: CuSn6 surface nickel and tin-plated	E3M152
	Jumper · straight / angled · Connector · For mobile 3D Smart sensor with analogue PAL video output · M12 connector · 16 m · for type O3M · Housing materials: housing: PUR / sealing: FKM / Contact pins: CuSn6 surface nickel and tin-plated	E3M153
	Jumper · straight / angled · Connector · For mobile 3D Smart sensor with analogue PAL video output · M12 connector · 21 m · for type O3M · Housing materials: housing: PUR / sealing: FKM / Contact pins: CuSn6 surface nickel and tin-plated	E3M154
	Extension cable · straight / straight · Connector · For mobile 3D Smart sensor with analogue PAL video output · M12 connector · 5 m · for type O3M · Housing materials: housing: PUR / sealing: FKM / Contact pins: CuSn6 surface nickel and tin-plated	E3M159
	Jumper · straight · M12 connector · Gold-plated contacts · For mobile 3D Smart sensor with analogue PAL video output · For connection of a video grabber · 1 m · Housing materials: PUR black	E3M160

Camera systems for PDM360 color and PDM360 NG

Type	Image resolution	Angle of aperture [°]	Additional functions	Interfaces	Drawing no.	Order no.
M16 connector						
	720 x 480	78	lens heating	Video signal analogue	5	O2M200
	720 x 480	78	Integrated mirror function lens heating	Video signal analogue	5	O2M201
	720 x 480	115	lens heating	Video signal analogue	5	O2M202
	720 x 480	115	Integrated mirror function lens heating	Video signal analogue	5	O2M203

Connection technology for displays

Type	Description	Order no.
	Adapter cable · straight / straight · M16 - M12 · Gold-plated contacts · Free from silicone · 0.6 m · Housing materials: housing: PVC / sealing: EPDM	E2M200
	Adapter cable · straight / straight · Y adapter cable M12 plug / 2 x M16 socket · Gold-plated contacts · Free from silicone · 0.95 m · Housing materials: housing: PVC / sealing: EPDM	E2M201
	Jumper · straight / straight · M16 - M16 · Gold-plated contacts · Free from silicone · 5 m · Housing materials: housing: PVC / sealing: EPDM	E2M203
	Jumper · straight / straight · M16 - M16 · Gold-plated contacts · Free from silicone · 16 m · Housing materials: housing: PVC / sealing: EPDM	E2M205
	Jumper · straight / straight · M16 - M16 · Gold-plated contacts · Free from silicone · 21 m · Housing materials: housing: PVC / sealing: EPDM	E2M206

Accessories

Type	Description	Order no.
	Video splitter · M16 connector · Housing materials: housing: stainless steel 316/1.4401	E2M250
	Socket · straight · Free from halogen · M16 connector · 3.85 m · Housing materials: housing: diecast zinc / sealing: PBT	E2M251
	Socket · straight · wirable · Free from halogen · M16 connector · Housing materials: housing: diecast zinc / sealing: PBT	E2M252
	protective housing · O2M2 · Housing materials: housing: 1.4301	E2M212
	Mounting bracket · O2M2 · Housing materials: housing: ABS reinforced glass-fibre / PC / PA	E2M211
	Vibration damper · O2M2 · Housing materials: Absorber: rubber / set screw: steel M6 x 15 mm	E2M213
	Mounting set · O2M2 · Housing materials: fixture: ABS	E2M210



Systems for mobile machines

Connection technology for displays

Type	Description	Order no.
	Ethernet switch · 5 ports · Autosensing · Autocrossing · 10/100Base-TX · Redundant voltage supply · 10...30 V DC	EC2095
	Jumper · straight / straight · Ethernet · Cross-over patch cable · 2 m · Housing materials: PUR / PC	E11898
	Jumper · straight / straight · Ethernet · Gold-plated contacts · 2 m · Housing materials: TPU	E21138
	Jumper · straight / straight · Ethernet · Gold-plated contacts · 5 m · Housing materials: TPU	E21139
	Jumper · straight / straight · Ethernet · Gold-plated contacts · 10 m · Housing materials: TPU	E21137

Scale drawings / drawing no. – CAD download: www.ifm.com

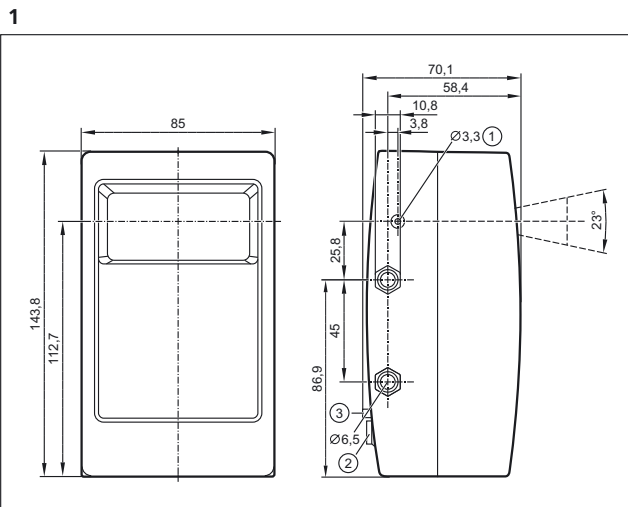

1: Reference socket, 2: Connections

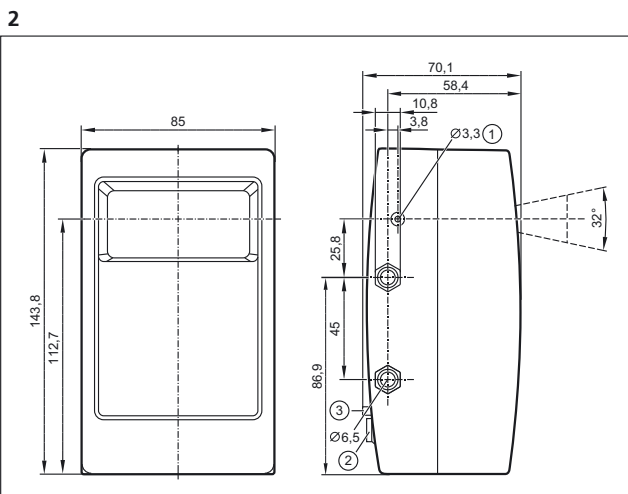
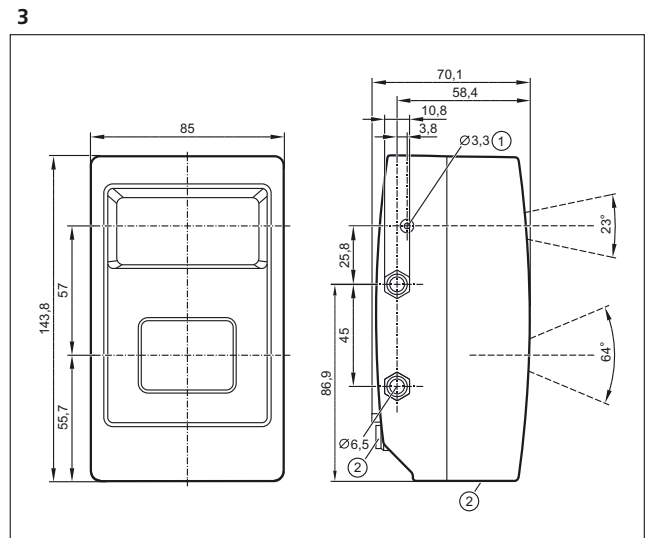

Scale drawings / drawing no. – CAD download: www.ifm.com

4

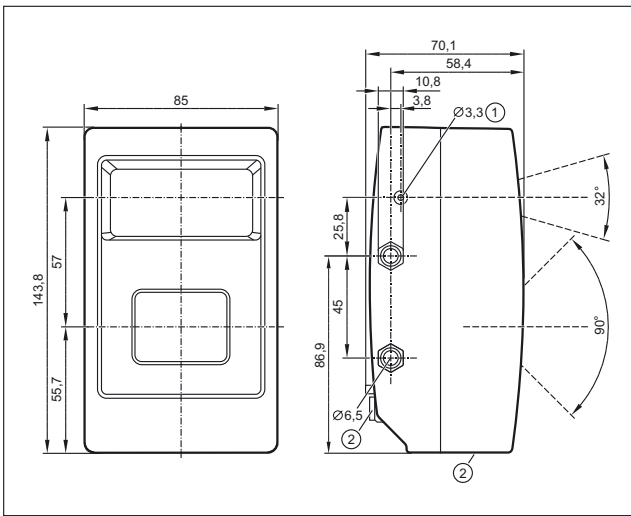

5

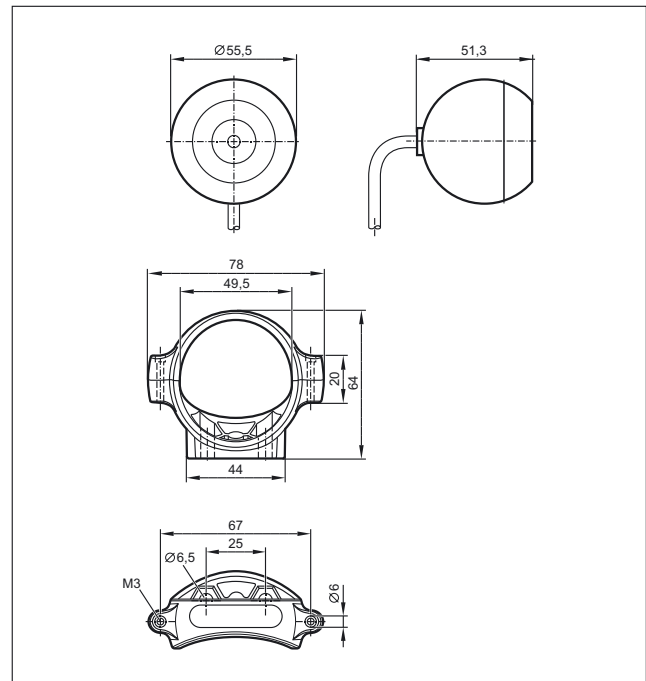



Systems for mobile machines



Diagnostic and service units

Detection of diagnostic data – the basis for a powerful and low-cost remote maintenance and monitoring concept.





Reduced service costs and standstill times in cases of failure are essential advantages of this modern technology.



System overview	Page
Remote maintenance	728
CAN interface and diagnosis	728 - 729
Accessories for remote maintenance	729
CAN cables	729
Scale drawings / drawing no. – CAD download: www.ifm.com	729 - 730

Remote maintenance

Type	Description	Draw- ing no.	Order no.
M12 connector, 5-pole · FME connector, GSM antenna · SMA socket, GPS antenna			
	CAN 3G/GPS radio modem · GSM/GPRS/EDGE (850/900/1800/1900 MHz) · UMTS/HSDPA (800/850/900/1700/1900/2100 MHz) · for the transfer of SMS messages and data packages · with GPS/Glonass receiver for location tracking · Shock sensor · aluminium powder-coated	1	CR3114

CAN interface and diagnosis

Type	Description	Draw- ing no.	Order no.
	CANfox · CAN/RS232-USB interface · Programming and diagnosis of CAN systems · 5 V DC (via USB interface)	2	EC2112
	Adapter cable · for CAN interface CANfox · CAN adapter: DIN connector, 6 poles / M12 connector, 5 poles · RS-232 adapter: DIN connector, 6 poles / Sub-D plug, 9 poles · Cable length 1 m	3	EC2113
	Real-time clock for CAN systems · Automotive relay housing · CAN interface · Parameter setting to IEC 61131 · Digital output · plastics:	4	CR3020
	CAN interface · polyamide	5	CR3130

Type	Description	Draw- ing no.	Order no.
	CAN interface · polyamide	6	CR3131
	Wifi / Bluetooth planar antenna · with integrated amplifier · Cable length 3 m · flat design for mounting on all plain surfaces · RP SMA plug	7	EC2118

Accessories for remote maintenance

Type	Description	Order no.
	GSM/GPS combined antenna · GSM 850/900/1800/1900 · UMTS 1920...2170 MHz · with integrated amplifier · Cable length 3 m · FME socket (GSM) · SMA plug (GPS) · flat design for mounting on all plain surfaces · e.g. for CANremote CR3114 · thread M16 x 1.5	EC2116

CAN cables

Type	Description	Order no.
	Adapter cable for CAN devices with M12 connector (5 pole) · e.g. CANmem, CANremote or inclination sensors	EC2062
	Wirable socket · straight · Free from silicone · Free from halogen · wirable · Gold-plated contacts · M12 connector · 5-pole · Housing materials: PA	E11511

Scale drawings / drawing no. – CAD download: www.ifm.com

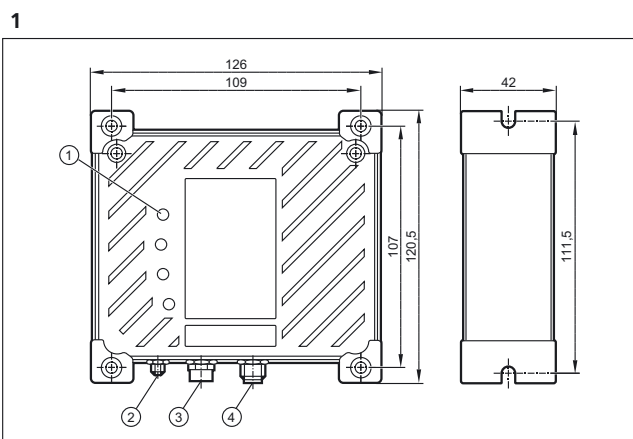

1: LEDs, 2: SMA socket, GPS antenna, 3: FME connector, GSM antenna, 4: M12 connector, 5-pole

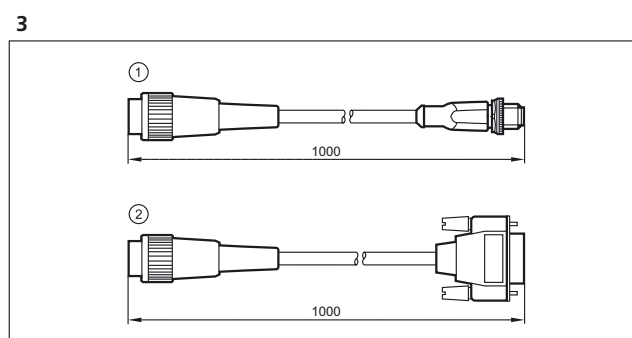
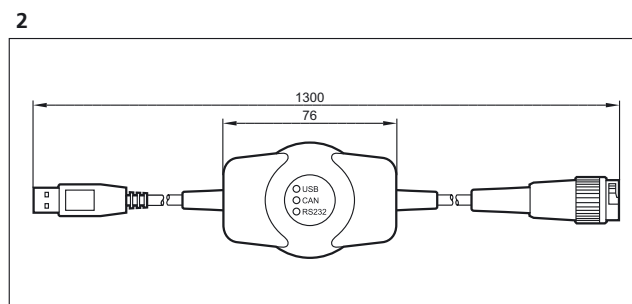

1: CAN adapter, 2: RS-232 adapter



**Systems for
mobile machines**

Scale drawings / drawing no. – CAD download: www.ifm.com

4

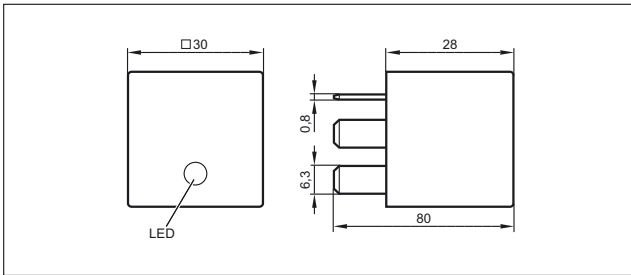

6

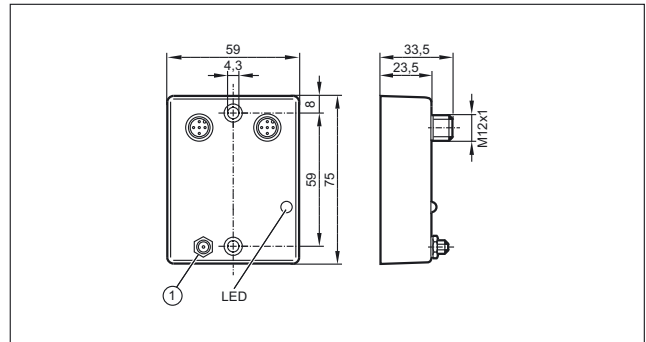

1: RP SMA socket

5

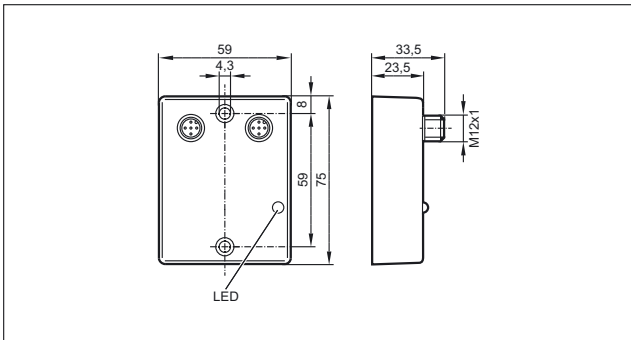

7

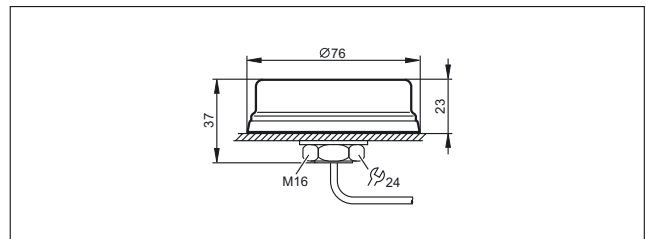





Systems for mobile machines



Signal converters

The solution provider for special applications. Signal converter to adapt sensor and actuator signals to the inputs and outputs of the controller or CANopen modules.

System overview	Page
Converters and PWM modules	732
Scale drawings / drawing no. – CAD download: www.ifm.com	732 - 733

Converters and PWM modules

Type	Description	Draw- ing no.	Order no.
	PWM / analogue module · PCB · Input 24 V DC PWM signal · Output 0...5 V DC	1	CR3001
	PWM / analogue module · PCB · Input 24 V DC PWM signal · Output 0...10 V DC	1	CR3002
	PWM / analogue module · Housing · Input 24 V DC PWM signal · Output 0...5 V DC	2	CR3003
	PWM / analogue module · Housing · Input 24 V DC PWM signal · Output 0...10 V DC	2	CR3004
	PWM / analogue module · Housing · Input 24 V DC PWM signal · Output 4...20 mA	2	CR3008
	DC/DC converter · Input 18...36 V DC · Output 10 V DC	3	EC2025

Scale drawings / drawing no. – CAD download: www.ifm.com

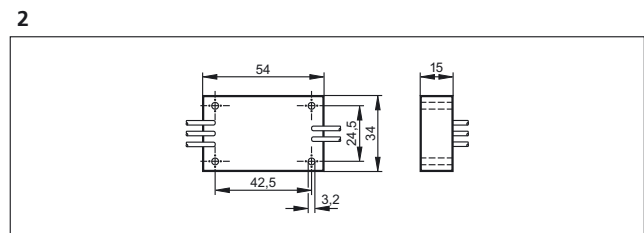
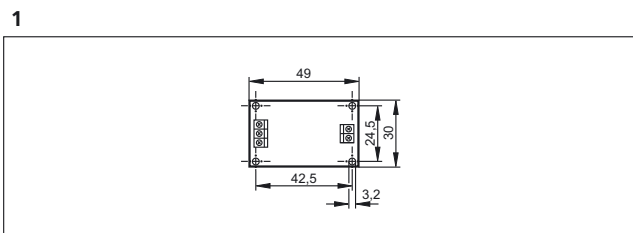

Scale drawings / drawing no. – CAD download: www.ifm.com

3

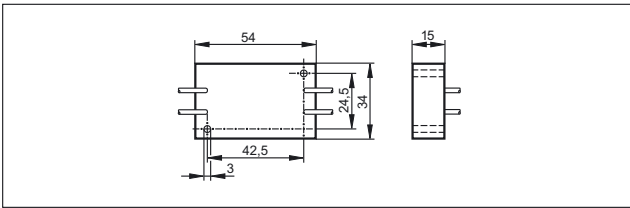



Systems for mobile machines



Sensors

From CAN-bus compatible or analogue inclination sensors to inductive proximity switches and pressure sensors for mobile applications.









The sensors of the ecomat*mobile* system are reliable even under the extreme conditions of use in a mobile machine.

System overview	Page
Absolute multiturn-encoders (CANopen) for mobile applications	734
RFID systems DTM424, DTM425, DTM434, DTM435 for mobile machines	735
CAN inclination sensors	735
Inclination sensors	736
Tilt sensors	736
Inductive sensors for mobile applications	736 - 738
Full metal sensors for industrial applications	738 - 739
Sensors for mobile applications	739
Electronic pressure sensors for mobile applications	739 - 742
Temperature transmitters for mobile applications	742 - 743
Accessories for sensors for mobile applications	743 - 744
Connection technology for sensors for mobile use	744 - 747
Wiring diagrams	747
Scale drawings / drawing no. – CAD download: www.ifm.com	748 - 751



Absolute multiturn-encoders (CANopen) for mobile applications

Type	Resolution	U _b [V]	f [kHz]	I _{load} [mA]	Shaft [mm]	Ambient temperature [°C]	Cable entry	Draw- ing no.	Order no.
M12 connector · Output function CANopen interface · Connector group 205									
	4096	9...30	–	–	10	-40...85	axial	1	RM9000
	4096	9...30	–	–	10	-40...85	axial	2	RM9001

RFID systems DTM424, DTM425, DTM434, DTM435 for mobile machines

Type	Description	Draw- ing no.	Order no.
Type M18 x 1 · M12 connector · CANopen interface			
	Read/write head · M18 x 1 · M12 connector · Housing materials: housing: stainless steel / Top: PPS / connector housing: PEI	3	DTM424
	Read/write head · M18 x 1 · M12 connector · Housing materials: housing: stainless steel / Top: PPS / connector housing: PEI	4	DTM425
Type M18 x 1 · M12 connector · J1939 interface			
	Read/write head · M18 x 1 · M12 connector · Housing materials: housing: stainless steel / Top: PPS / connector housing: PEI	3	DTM426
	Read/write head · M18 x 1 · M12 connector · Housing materials: housing: stainless steel / Top: PPS / connector housing: PEI	4	DTM427
Type M30 x 1.5 · M12 connector · CANopen interface			
	Read/write head · M30 x 1.5 · M12 connector · Housing materials: housing: stainless steel / Top: PPS / connector housing: PEI	5	DTM434
	Read/write head · M30 x 1.5 · M12 connector · Housing materials: housing: stainless steel / Top: PPS / connector housing: PEI	6	DTM435
Type M30 x 1.5 · M12 connector · J1939 interface			
	Read/write head · M30 x 1.5 · M12 connector · Housing materials: housing: stainless steel / Top: PPS / connector housing: PEI	5	DTM436
	Read/write head · M30 x 1.5 · M12 connector · Housing materials: housing: stainless steel / Top: PPS / connector housing: PEI	6	DTM437

CAN inclination sensors

Type	Angular range [°]	Number of axes	Resolution / accuracy [°]	Interfaces	Wiring diag. no.	Draw- ing no.	Order no.
2 x M12 connection (CAN-In / CAN-Out)							
	0...360° / ± 180°	2	0.001 / ≤ ± 0.5°	1 x CAN	–	7	JN2100
	± 45°	2	0.001 / ± 0.01°	1 x CAN	–	7	JN2101



Systems for mobile machines



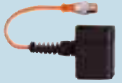

Inclination sensors















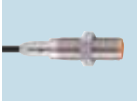

Type	Angular range [°]	Supply voltage	Output signal	Repeatability [°]	Drawing no.	Order no.
Cable						
	±90°	15...30 V DC	1 x analogue (0...10 V)	0.1°	8	EC2019
	±90°	8...30 DC	1 x analogue (0.5...4.5 V)	0.1°	8	EC2045
Cable with M12 connector						
	±20°	11...15 V DC	1 x analogue (4...20 mA)	0.1°	8	EC2060
	±90°	20...30 V DC	1 x analogue (4...20 mA)	0.1°	8	EC2082

Tilt sensors

Type	Angular range [°]	Supply voltage	Output signal	Repeatability [°]	Drawing no.	Order no.
Cable						
	2.5...5.5°	10...30 V DC	1 x Digital	0.2°	9	EC2061







Inductive sensors for mobile applications

Type	Dimensions [mm]	Sensing range [mm]	Material	U _b [V]	Protection	f [Hz]	I _{load} [mA]	Drawing no.	Order no.
Cable 6 m · Output function  · DC PNP · Wiring diagram no. 1									
	M12 / L = 79	4 f	stainless steel	10...60	IP 67 / IP 69K	400	200	10	IFM209
	M12 / L = 79	7 nf	High-grade st. steel	10...60	IP 67 / IP 69K	300	200	11	IFM210
	M18 / L = 81	8 f	stainless steel	10...60	IP 67 / IP 69K	200	200	12	IGM206
	M18 / L = 81	12 nf	stainless steel	10...60	IP 67 / IP 69K	200	200	13	IGM207

Type	Dimensions [mm]	Sensing range [mm]	Material	U _b [V]	Protection	f [Hz]	I _{load} [mA]	Draw- ing no.	Order no.
Cable 6 m · Output function  · DC PNP · Wiring diagram no. 1									
	M30 / L = 81	12 f	stainless steel	10...60	IP 67 / IP 69K	100	200	14	IIM210
	M30 / L = 81	22 nf	stainless steel	10...60	IP 67 / IP 69K	100	200	15	IIM211
Cable 6 m · Output function  · 3-wire DC PNP; 2-wire DC PNP/NPN · Wiring diagram no. 11									
	M12 / L = 79	4 f	stainless steel	10...36	IP 67 / IP 69K	400	100	10	IFM207
	M12 / L = 79	7 nf	stainless steel	10...36	IP 67 / IP 69K	300	100	11	IFM208
	M18 / L = 81	8 f	stainless steel	10...36	IP 67 / IP 69K	200	100	12	IGM202
	M18 / L = 81	12 nf	stainless steel	10...36	IP 67 / IP 69K	200	100	13	IGM203
	M30 / L = 81	12 f	stainless steel	10...36	IP 67 / IP 69K	100	100	14	IIM202
	M30 / L = 81	22 nf	stainless steel	10...36	IP 67 / IP 69K	100	100	15	IIM203
M12 connector · Output function  · DC PNP · Wiring diagram no. 2 · Connector groups 202, 203, 204									
	M12 / L = 70	4 f	High-grade st. steel	10...60	IP 67 / IP 69K	400	200	16	IFM205
	M12 / L = 70	7 nf	stainless steel	10...60	IP 67 / IP 69K	300	200	17	IFM206
	M18 / L = 70	8 f	stainless steel	10...60	IP 67 / IP 69K	200	200	18	IGM204
	M18 / L = 70	12 nf	stainless steel	10...60	IP 67 / IP 69K	200	200	19	IGM205
	M30 / L = 70	12 f	stainless steel	10...60	IP 67 / IP 69K	100	200	20	IIM208
	M30 / L = 70	22 nf	stainless steel	10...60	IP 67 / IP 69K	100	200	21	IIM209

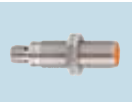





Systems for mobile machines

Type	Dimensions [mm]	Sensing range [mm]	Material	U _b [V]	Protection	f [Hz]	I _{load} [mA]	Drawing no.	Order no.
M12 connector · Output function $\text{—} \text{—}$ · 3-wire DC PNP; 2-wire DC PNP/NPN · Wiring diagram no. 12 · Connector groups 202, 203, 204									
	M12 / L = 70	4 f	High-grade st. steel	10...36	IP 67 / IP 69K	400	100	16	IFM203
	M12 / L = 70	7 nf	High-grade st. steel	10...36	IP 67 / IP 69K	300	100	17	IFM204
	M18 / L = 70	8 f	stainless steel	10...36	IP 67 / IP 69K	200	100	18	IGM200
	M18 / L = 70	12 nf	stainless steel	10...36	IP 67 / IP 69K	200	100	19	IGM201
	M30 / L = 70	12 f	stainless steel	10...36	IP 67 / IP 69K	100	100	20	IIM200
	M30 / L = 70	22 nf	stainless steel	10...36	IP 67 / IP 69K	100	100	21	IIM201

f = flush / nf = non flush / qf = quasi-flush

Full metal sensors for industrial applications

Type	Dimensions [mm]	Sensing range [mm]	Material	U _b [V]	Protection	f [Hz]	I _{load} [mA]	Drawing no.	Order no.
M12 connector · Output function $\text{—} \text{—}$ · DC PNP · Wiring diagram no. 2 · Connector groups 8, 10, 11, 18, 19, 21, 23, 25, 148, 149, 150, 153, 154, 184, 188, 190, 193, 202, 203, 204									
	M12 / L = 93	1.8 f	High-grade st. steel	10...36	IP 65 / IP 68 / IP 69K	1000	200	22	MFH200
M12 connector · Output function $\text{—} \text{—}$ · DC NPN · Wiring diagram no. 3 · Connector groups 8, 10, 19, 21, 23, 25, 148, 149, 153, 184, 188, 193, 202									
	M12 / L = 93	1.8 f	High-grade st. steel	10...36	IP 65 / IP 68 / IP 69K	1000	200	22	MFH201
M12 connector · Output function $\text{—} \text{—}$ · DC PNP · Wiring diagram no. 2 · Connector groups 8, 10, 11, 18, 19, 21, 23, 25, 148, 149, 150, 153, 154, 184, 188, 190, 193, 202, 203, 204									
	M12 / L = 60	1.8 f	High-grade st. steel	10...36	IP 65 / IP 68 / IP 69K	1000	200	23	MFH202
M12 connector · Output function $\text{—} \text{—}$ · DC NPN · Wiring diagram no. 3 · Connector groups 8, 10, 19, 21, 23, 25, 148, 149, 153, 184, 188, 193, 202									
	M12 / L = 60	1.8 f	High-grade st. steel	10...36	IP 65 / IP 68 / IP 69K	1000	200	23	MFH203

Type	Dimensions [mm]	Sensing range [mm]	Material	U _b [V]	Protection	f [Hz]	I _{load} [mA]	Draw- ing no.	Order no.
------	--------------------	--------------------------	----------	-----------------------	------------	-----------	---------------------------	---------------------	--------------

M12 connector · Output function  · DC PNP · Wiring diagram no. 4 · Connector groups 8, 10, 19, 21, 23, 25, 148, 149, 153, 184, 188, 193, 202

	M12 / L = 60	1.8 f	High-grade st. steel	10...36	IP 65 / IP 68 / IP 69K	1000	200	23	MFH204
---	--------------	-------	----------------------	---------	------------------------	------	-----	----	--------

M12 connector · Output function  · DC PNP · Wiring diagram no. 2 · Connector groups 8, 10, 11, 18, 19, 21, 23, 25, 148, 149, 150, 153, 154, 184, 188, 190, 193, 202, 203, 204

	M14 / L = 53	2 f	High-grade st. steel	10...36	IP 65 / IP 68 / IP 69K	1000	200	24	M9H200
---	--------------	-----	----------------------	---------	------------------------	------	-----	----	--------

f = flush / nf = non flush / qf = quasi-flush

Sensors for mobile applications

Type	Dimensions [mm]	Sensing range [mm]	Material	U _b [V]	Protection	f [Hz]	I _{load} [mA]	Draw- ing no.	Order no.
------	--------------------	--------------------------	----------	-----------------------	------------	-----------	---------------------------	---------------------	--------------

Cable with connector 0.15 m · Output function  · DC PNP · Wiring diagram no. 2 · Connector groups 1, 2, 3, 78, 84, 145, 146

	40 x 12 x 26	60	PBT	10...30	IP 67	–	200	25	MN5200
---	--------------	----	-----	---------	-------	---	-----	----	--------

Electronic pressure sensors for mobile applications











Type	Process connection	Display	Measuring range [bar]	P _{overload} max. [bar]	P _{bursting} min. [bar]	U _b DC [V]	Draw- ing no.	Order no.
------	-----------------------	---------	-----------------------------	-------------------------------------	-------------------------------------	-----------------------------	---------------------	--------------













AMP Superseal · Output function 0...10 V analogue · Wiring diagram no. 5

	G ¼ A	–	0...400	1000	1700	16...32	26	PU5600
	G ¼ A	–	0...250	625	1200	16...32	26	PU5601
	G ¼ A	–	0...100	250	1000	16...32	26	PU5602
	G ¼ A	–	0...25	65	600	16...32	26	PU5603
	G ¼ A	–	0...10	25	300	16...32	26	PU5604
	G ¼ A	–	0...600	1500	2500	16...32	26	PU5660

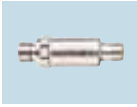

Systems for mobile machines

Type	Process connection	Display	Measuring range [bar]	P _{overload} max. [bar]	P _{bursting} min. [bar]	U _b DC [V]	Draw- ing no.	Order no.
DEUTSCH connector DT04-3P · Output function 0...10 V analogue · Wiring diagram no. 6								
	G ¼ A	–	0...400	1000	1700	16...32	27	PU5700
	G ¼ A	–	0...250	625	1200	16...32	27	PU5701
	G ¼ A	–	0...100	250	1000	16...32	27	PU5702
	G ¼ A	–	0...25	65	600	16...32	27	PU5703
	G ¼ A	–	0...10	25	300	16...32	27	PU5704
	G ¼ A	–	0...600	1500	2500	16...32	27	PU5760
AMP Superseal · Output function 4...20 mA analogue · Wiring diagram no. 7								
	G ¼ A	–	0...400	1000	1700	8...32	26	PT5600
	G ¼ A	–	0...250	625	1200	8...32	26	PT5601
	G ¼ A	–	0...100	250	1000	8...32	26	PT5602
	G ¼ A	–	0...25	65	600	8...32	26	PT5603
	G ¼ A	–	0...10	25	300	8...32	26	PT5604
	G ¼ A	–	0...600	1500	2500	8...32	26	PT5660
DEUTSCH connector DT04-3P · Output function 4...20 mA analogue · Wiring diagram no. 8								
	G ¼ A	–	0...400	1000	1700	8...32	27	PT5700
	G ¼ A	–	0...250	625	1200	8...32	27	PT5701
	G ¼ A	–	0...100	250	1000	8...32	27	PT5702

Type	Process connection	Display	Measuring range [bar]	P _{overload} max. [bar]	P _{bursting} min. [bar]	U _b DC [V]	Draw- ing no.	Order no.
DEUTSCH connector DT04-3P · Output function 4...20 mA analogue · Wiring diagram no. 8								
	G ¼ A	–	0...25	65	600	8...32	27	PT5703
	G ¼ A	–	0...10	25	300	8...32	27	PT5704
	G ¼ A	–	0...600	1500	2500	8...32	27	PT5760
DEUTSCH connector DT04-3P · Wiring diagram no. 6								
	G ¼	–	0...400	1000	1700	8...32	27	PU8700
	G ¼	–	0...250	625	1200	8...32	27	PU8701
	G ¼	–	0...100	250	1000	8...32	27	PU8702
	G ¼	–	0...25	65	600	8...32	27	PU8703
	G ¼	–	0...10	25	300	8...32	27	PU8704
	G ¼	–	0...160	400	1100	8...32	27	PU8712
	G ¼	–	0...40	100	800	8...32	27	PU8743
	G ¼	–	0...600	1500	2500	8...32	27	PU8760
M12 connector · Output function 4...20 mA analogue · Wiring diagram no. 9 · Connector groups 8, 10, 19, 21, 23, 25, 148, 149, 153, 184, 188, 193, 202								
	G ¼ A	–	0...600	1500	2500	8...32	28	PT5560
	G ¼ A	–	0...400	1000	1700	8...32	28	PT5500
	G ¼ A	–	0...250	625	1200	8...32	28	PT5501



Systems for mobile machines

Type	Process connection	Display	Measuring range [bar]	P _{overload} max. [bar]	P _{bursting} min. [bar]	U _b DC [V]	Drawing no.	Order no.
------	--------------------	---------	--------------------------	-------------------------------------	-------------------------------------	-----------------------------	-------------	-----------

M12 connector · Output function 4...20 mA analogue · Wiring diagram no. 9 · Connector groups 8, 10, 19, 21, 23, 25, 148, 149, 153, 184, 188, 193, 202

	G ¼ A	–	0...100	250	1000	8...32	28	PT5502
	G ¼ A	–	0...25	65	600	8...32	28	PT5503
	G ¼ A	–	0...10	25	300	8...32	28	PT5504

M12 connector · Output function 0...10 V analogue · Wiring diagram no. 10 · Connector group 202

	G ¼ A	–	0...400	600	1600	16...36	29	PT9550
	G ¼ A	–	0...250	400	1000	16...36	29	PT9551
	G ¼ A	–	0...100	200	1000	16...36	29	PT9552
	G ¼ A	–	0...25	60	600	16...36	29	PT9553
	G ¼ A	–	0...10	25	300	16...36	29	PT9554

Temperature transmitters for mobile applications









Type	Measuring range [°C / °F]	Process connection	Installation length [mm]	U _b [V]	Dynamic response T05 / T09 [s]	Drawing no.	Order no.
------	------------------------------	--------------------	-----------------------------	-----------------------	--------------------------------------	-------------	-----------

M12 connector · high-grade stainless steel · DC · Connector groups 8, 10, 19, 21, 23, 25, 148, 149, 153, 184, 188, 193, 202

	-50...150 / -58...302	G ¼ A	25	10...30	1 / 3	30	TA3105
	-50...150 / -58...302	G ¼ A	50	10...30	1 / 3	30	TA3115
	-50...150 / -58...302	G ¼ A	200	10...30	1 / 3	30	TA3155

DEUTSCH connector · high-grade stainless steel · DC

	-50...150 / -58...302	G ¼ A	25	10...30	1 / 3	31	TA4105
--	-----------------------	-------	----	---------	-------	----	--------

Type	Measuring range [°C / °F]	Process connection	Installation length [mm]	U _b [V]	Dynamic response T05 / T09 [s]	Drawing no.	Order no.
DEUTSCH connector · high-grade stainless steel · DC							
	-50...150 / -58...302	G ¼ A	50	10...30	1 / 3	31	TA4115
AMP plug · high-grade stainless steel · DC							
	-50...150 / -58...302	G ¼ A	25	10...30	1 / 3	32	TA5105
	-50...150 / -58...302	G ¼ A	50	10...30	1 / 3	32	TA5115
M12 connector · high-grade stainless steel · DC · Connector groups 8, 10, 19, 21, 23, 25, 148, 149, 153, 184, 188, 193, 202							
	-50...150 / -58...302	G ¼ A	25	8...32	1 / 3	30	TU3105
DEUTSCH connector · high-grade stainless steel · DC							
	-50...150 / -58...302	G ¼ A	25	8...32	1 / 3	31	TU4105
AMP plug · high-grade stainless steel · DC							
	-50...150 / -58...302	G ¼ A	25	8...32	1 / 3	32	TU5105
M12 connector · high-grade stainless steel · Connector groups 8, 10, 19, 21, 23, 25, 148, 149, 153, 184, 188, 193, 202							
	-40...150 / -40...302	G ¼	25	–	1 / 3	33	TM5101
DEUTSCH connector · high-grade stainless steel							
	-40...150 / -40...302	G 1/4	25	–	1 / 3	34	TM6101

Accessories for sensors for mobile applications

Type	Description	Order no.
	Mounting clamp · Ø 12 mm · with end stop · for type M12 · Housing materials: PC	E11047
	Mounting clamp · Ø 18 mm · with end stop · for type M18 · Housing materials: PC	E11048



Systems for mobile machines

Type	Description	Order no.
	Mounting clamp · Ø 30 mm · with end stop · for type M30 · Housing materials: PC	E11049
	Angle bracket · for type M12 · Housing materials: stainless steel	E10735
	Angle bracket · for type M18 · Housing materials: stainless steel	E10736
	Angle bracket · for type M30 · Housing materials: stainless steel	E10737

Connection technology for sensors for mobile use







Type	Description	Order no.
	Jumper · straight / straight · Free from silicone · Free from halogen · Gold-plated contacts · 0.3 m · Housing materials: housing: TPU orange / sealing: FKM	EVC010
	Jumper · straight / straight · Free from silicone · Free from halogen · Gold-plated contacts · 1 m · Housing materials: housing: TPU orange / sealing: FKM	EVC012
	Socket · angled · Free from silicone · Free from halogen · Gold-plated contacts · M12 connector · 2 m · Housing materials: housing: TPU orange / sealing: FKM	EVC004
	Socket · angled · Free from silicone · Free from halogen · Gold-plated contacts · M12 connector · 5 m · Housing materials: housing: TPU orange / sealing: FKM	EVC005
	Socket · angled · Free from silicone · Free from halogen · Gold-plated contacts · M12 connector · 10 m · Housing materials: housing: TPU orange / sealing: FKM	EVC006
	Socket · straight · Free from silicone · Free from halogen · Gold-plated contacts · M12 connector · 2 m · Housing materials: housing: TPU orange / sealing: FKM	EVC001
	Socket · straight · Free from silicone · Free from halogen · Gold-plated contacts · M12 connector · 5 m · Housing materials: housing: TPU orange / sealing: FKM	EVC002
	Socket · straight · Free from silicone · Free from halogen · Gold-plated contacts · M12 connector · 10 m · Housing materials: housing: TPU orange / sealing: FKM	EVC003
	Socket · straight · Free from silicone · Free from halogen · Gold-plated contacts · M12 connector · 2 m · Housing materials: housing: TPU orange / sealing: FKM	EVC526
	Socket · straight · Free from silicone · Free from halogen · Gold-plated contacts · M12 connector · 5 m · Housing materials: housing: TPU orange / sealing: FKM	EVC527



Type	Description	Order no.
	Socket · straight · Free from silicone · Free from halogen · Gold-plated contacts · M12 connector · 10 m · Housing materials: housing: TPU orange / sealing: FKM	EVC528
	Socket · angled · Free from silicone · Free from halogen · Gold-plated contacts · M12 connector · 2 m · Housing materials: housing: TPU orange / sealing: FKM	EVC529
	Socket · angled · Free from silicone · Free from halogen · Gold-plated contacts · M12 connector · 5 m · Housing materials: housing: TPU orange / sealing: FKM	EVC530
	Socket · angled · Free from silicone · Free from halogen · Gold-plated contacts · M12 connector · 10 m · Housing materials: housing: TPU orange / sealing: FKM	EVC531
	Socket · straight · Free from silicone · Free from halogen · Gold-plated contacts · M12 connector · 2 m · Housing materials: housing: TPU orange / sealing: FKM	EVC532
	Socket · straight · Free from silicone · Free from halogen · Gold-plated contacts · M12 connector · 5 m · Housing materials: housing: TPU orange / sealing: FKM	EVC533
	Socket · straight · Free from silicone · Free from halogen · Gold-plated contacts · M12 connector · 10 m · Housing materials: housing: TPU orange / sealing: FKM	EVC534
	Socket · angled · Free from silicone · Free from halogen · Gold-plated contacts · M12 connector · 2 m · Housing materials: housing: TPU orange / sealing: FKM	EVC535
	Socket · angled · Free from silicone · Free from halogen · Gold-plated contacts · M12 connector · 5 m · Housing materials: housing: TPU orange / sealing: FKM	EVC536
	Socket · angled · Free from silicone · Free from halogen · Gold-plated contacts · M12 connector · 10 m · Housing materials: housing: TPU orange / sealing: FKM	EVC537
	Socket · straight · Free from silicone · Free from halogen · Gold-plated contacts · M12 connector · 2 m · Housing materials: housing: TPU orange / sealing: FKM	EVC538
	Socket · straight · Free from silicone · Free from halogen · Gold-plated contacts · M12 connector · 5 m · Housing materials: housing: TPU orange / sealing: FKM	EVC539
	Socket · straight · Free from silicone · Free from halogen · Gold-plated contacts · M12 connector · 10 m · Housing materials: housing: TPU orange / sealing: FKM	EVC540
	Socket · angled · Free from silicone · Free from halogen · Gold-plated contacts · M12 connector · 2 m · Housing materials: housing: TPU orange / sealing: FKM	EVC541
	Socket · angled · Free from silicone · Free from halogen · Gold-plated contacts · M12 connector · 5 m · Housing materials: housing: TPU orange / sealing: FKM	EVC542
	Socket · angled · Free from silicone · Free from halogen · Gold-plated contacts · M12 connector · 10 m · Housing materials: housing: TPU orange / sealing: FKM	EVC543

You can find wiring diagrams and scale drawings from page 747



Systems for mobile machines

Type	Description	Order no.
	Socket · straight · Free from silicone · Free from halogen · Gold-plated contacts · M12 connector · 2 m · Housing materials: housing: TPU orange / sealing: FKM	EVC544
	Socket · straight · Free from silicone · Free from halogen · Gold-plated contacts · M12 connector · 5 m · Housing materials: housing: TPU orange / sealing: FKM	EVC545
	Socket · straight · Free from silicone · Free from halogen · Gold-plated contacts · M12 connector · 10 m · Housing materials: housing: TPU orange / sealing: FKM	EVC546
	Socket · angled · Free from silicone · Free from halogen · Gold-plated contacts · M12 connector · 2 m · Housing materials: housing: TPU orange / sealing: FKM	EVC547
	Socket · angled · Free from silicone · Free from halogen · Gold-plated contacts · M12 connector · 5 m · Housing materials: housing: TPU orange / sealing: FKM	EVC548
	Socket · angled · Free from silicone · Free from halogen · Gold-plated contacts · M12 connector · 10 m · Housing materials: housing: TPU orange / sealing: FKM	EVC549
	Socket · straight · Free from halogen · Gold-plated contacts · M12 connector · 2 m · Housing materials: PUR	E11596
	Socket · straight · Free from halogen · Gold-plated contacts · M12 connector · 5 m · Housing materials: PUR	E11597
	Terminating resistor socket · straight · Gold-plated contacts · M12 connector · Housing materials: TPU	E11589
	Terminating resistor plug · straight · Gold-plated contacts · M12 connector · Housing materials: TPU	E11590
	Cable plug · straight · Free from halogen · Gold-plated contacts · M12 connector · 2 m · Housing materials: PUR	E11598
	Cable plug · straight · Free from halogen · Gold-plated contacts · M12 connector · 5 m · Housing materials: PUR	E11599
	Jumper · straight / straight · Free from halogen · Gold-plated contacts · 0.3 m · Housing materials: PUR	E11591
	Jumper · straight / straight · Free from halogen · Gold-plated contacts · 1 m · Housing materials: PUR	E11592
	Jumper · straight / straight · Free from halogen · Gold-plated contacts · 2 m · Housing materials: PUR	E11593

Type	Description	Order no.
	Jumper · straight / straight · Free from halogen · Gold-plated contacts · 5 m · Housing materials: PUR	E11594
	Socket · angled · Free from silicone · Free from halogen · Gold-plated contacts · M12 connector with integrated CAN terminating resistor (120 ohm) · 5 m · Housing materials: housing: TPU black / sealing: FKM	EVC492
	Cable plug · angled · Free from silicone · Free from halogen · Gold-plated contacts · M12 connector · 6 m · Housing materials: housing: TPU black	E12215

Wiring diagrams

Core colours

- BK black
- BN brown
- BU blue
- WH white

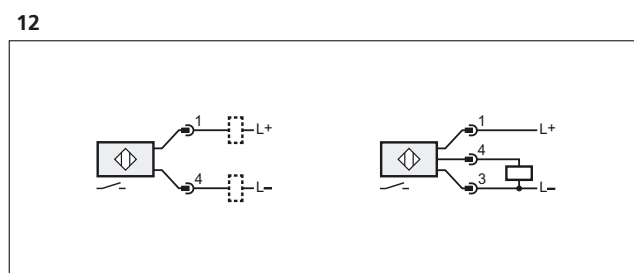
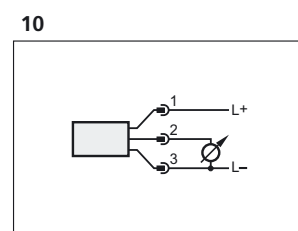
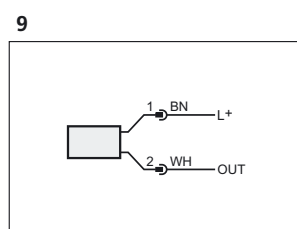
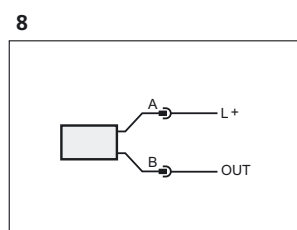
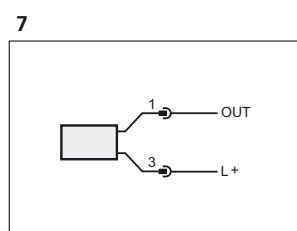
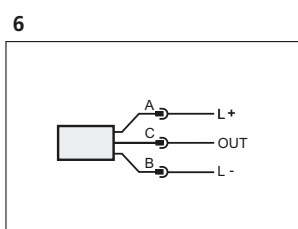
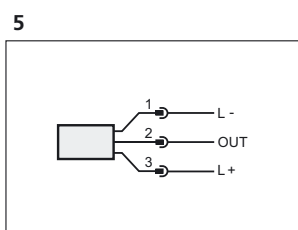
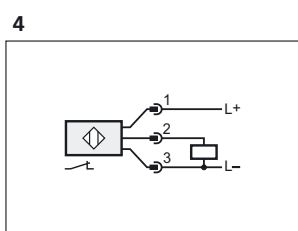
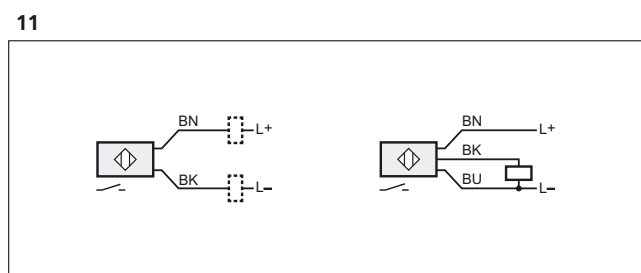
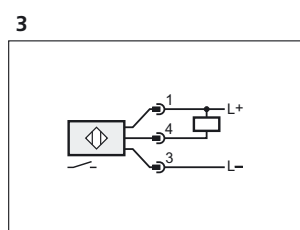
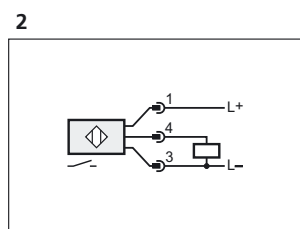
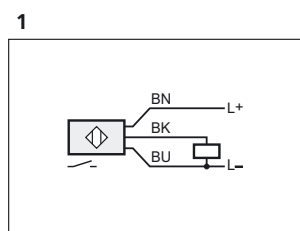



**Systems for
mobile machines**

Scale drawings / drawing no. – CAD download: www.ifm.com

1

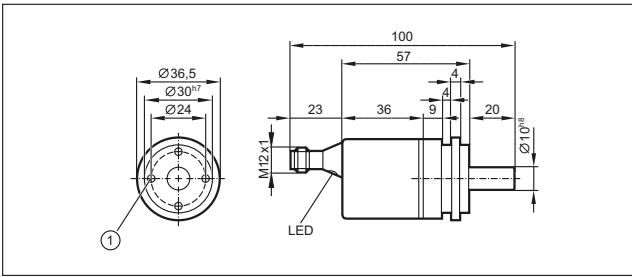

2

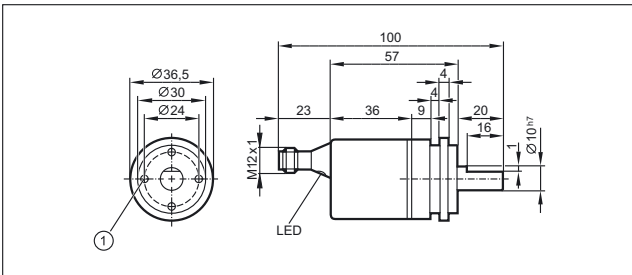

3

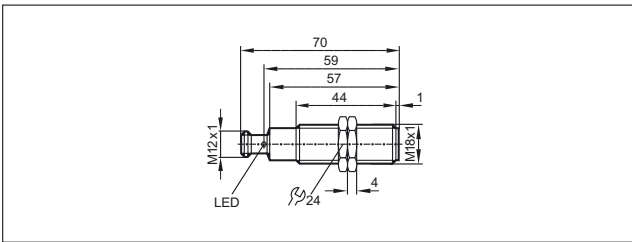

4

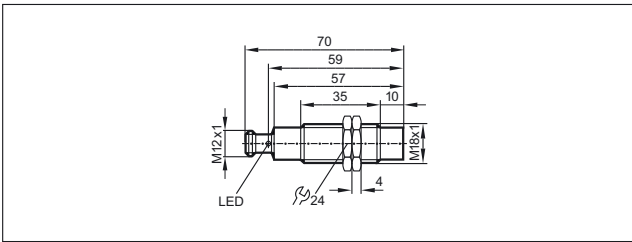

5

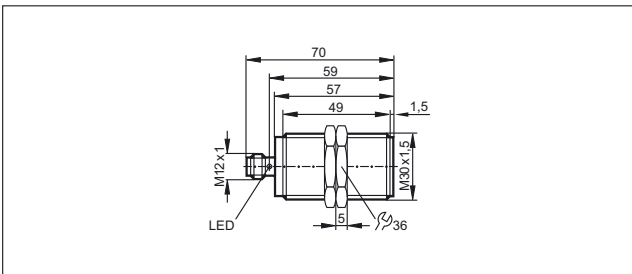

6

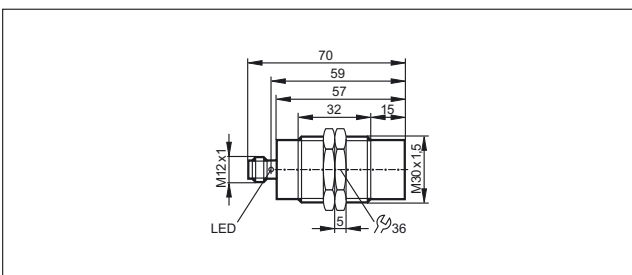

7

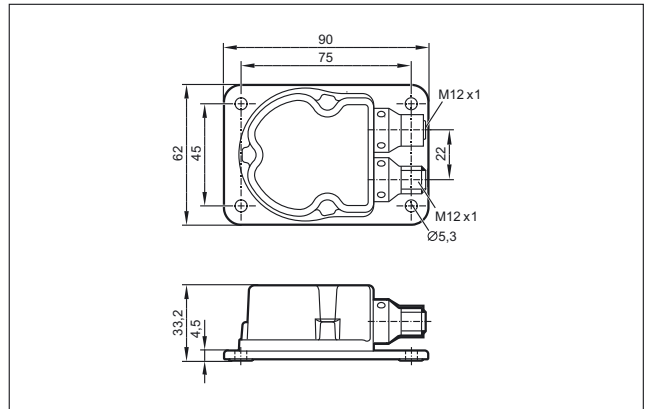

8

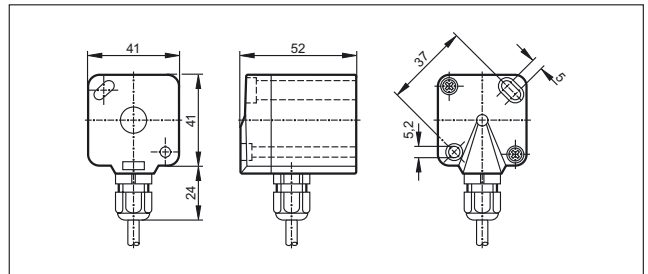

9

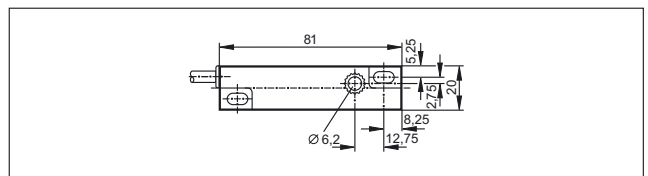

10

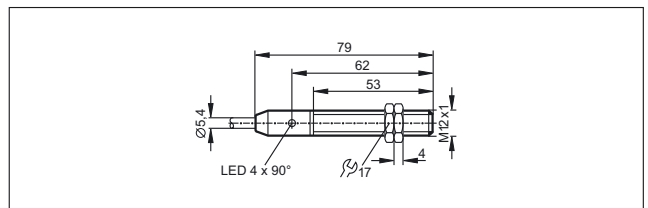

11

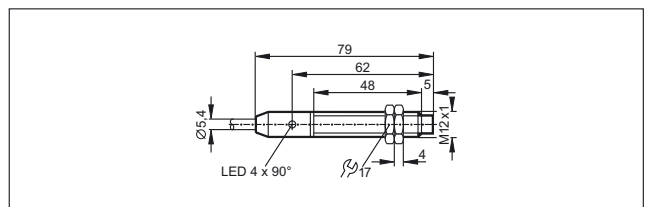

12

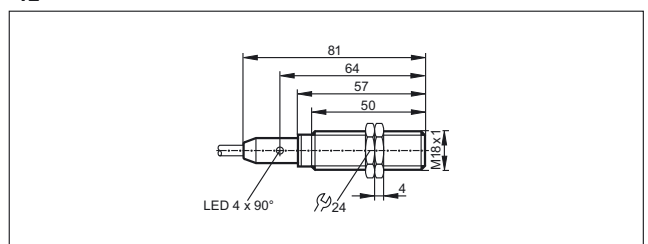

Scale drawings / drawing no. – CAD download: www.ifm.com

13

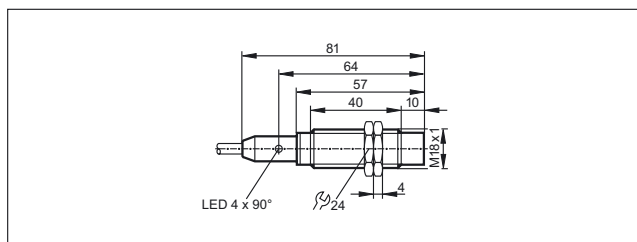

19

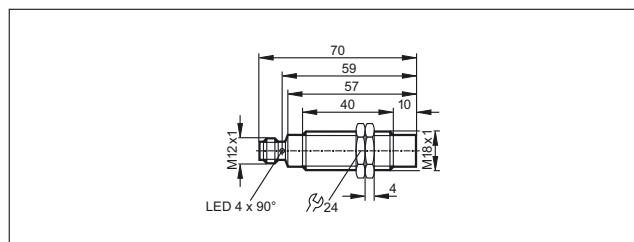

14

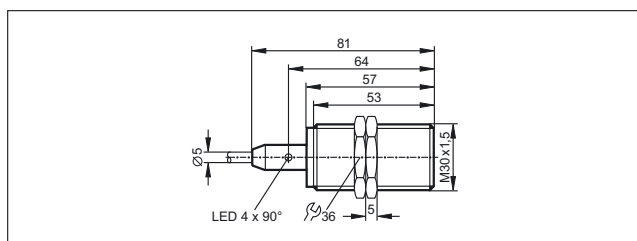

20

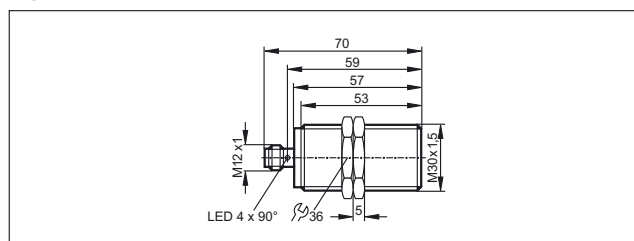

15

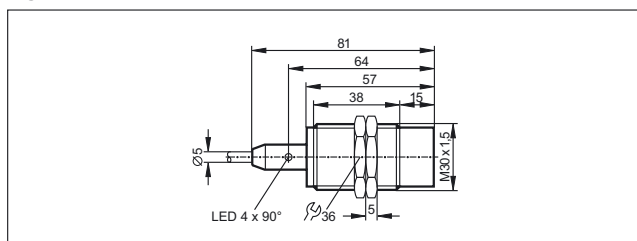

21

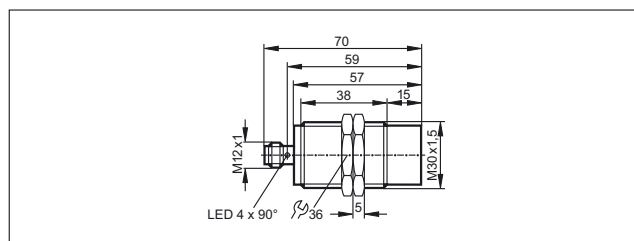

16

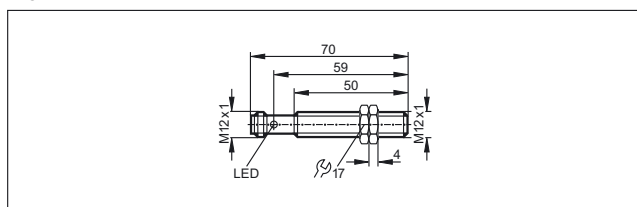

22

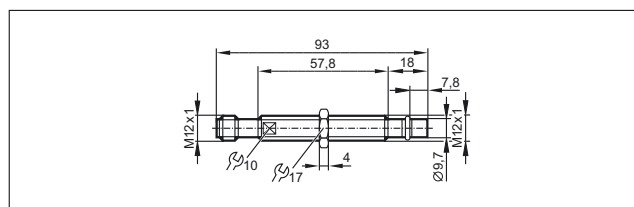

17

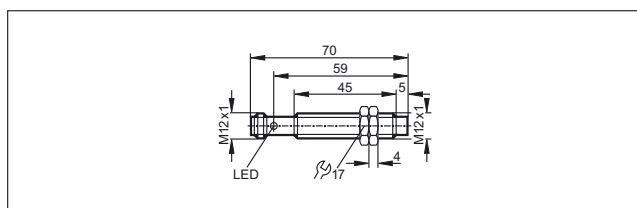

23

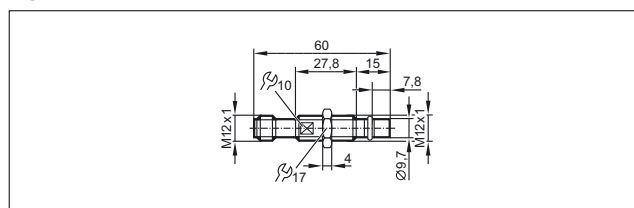

18

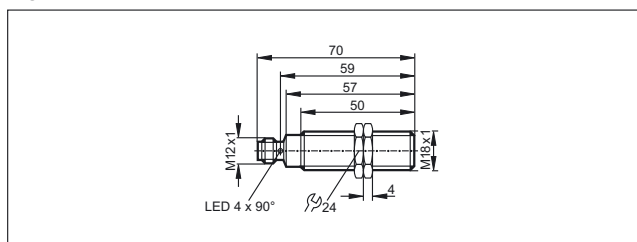

24

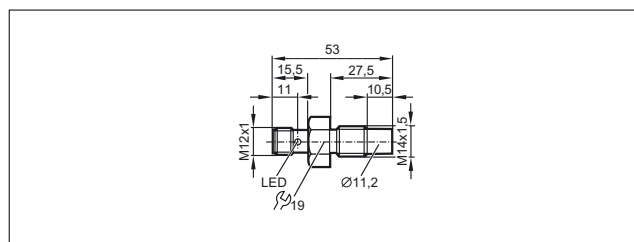



**Systems for
mobile machines**

Scale drawings / drawing no. – CAD download: www.ifm.com

25

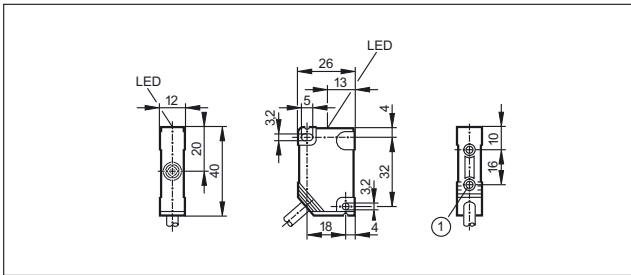

1: threaded insert M3, depth 5.8 mm, max. tightening torque 1.2 Nm (screw fixing class 8.8) when brass insert in contact with counterpart.

29

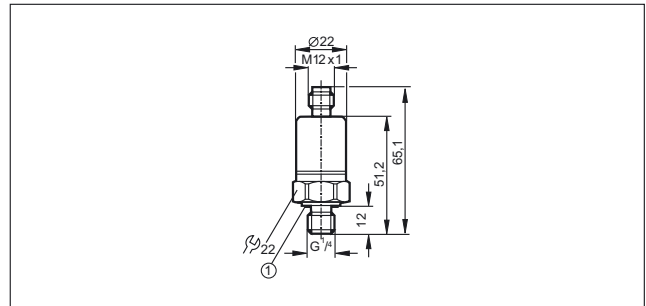

1: FKM seal / DIN 3869-14, tightening torque 25 Nm

26

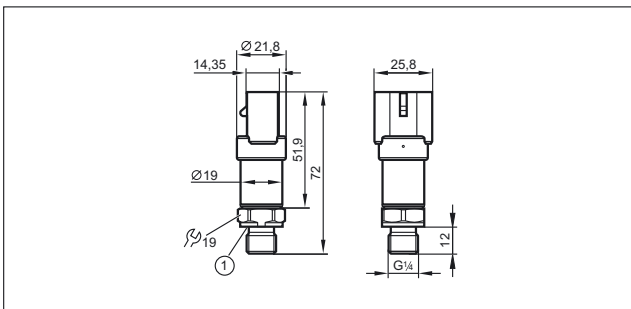

1: sealing FKM / DIN 3869

30

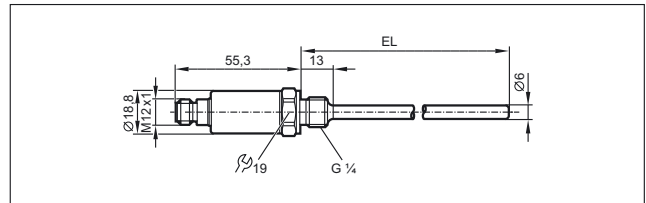

31

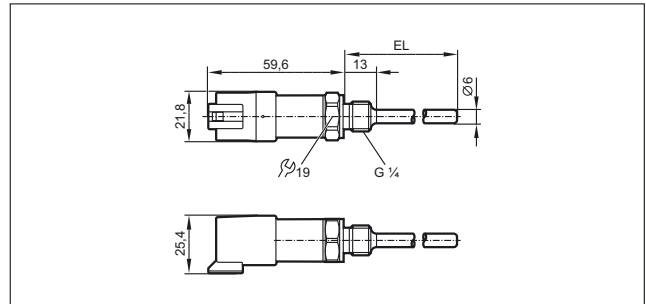

32

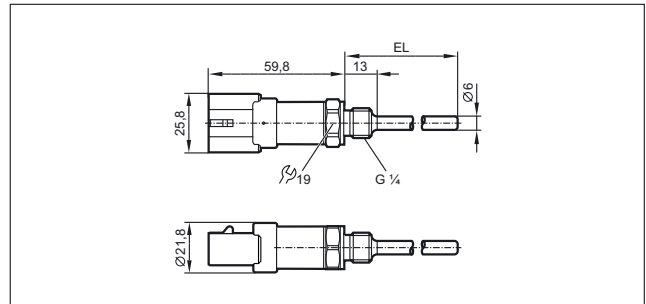

33

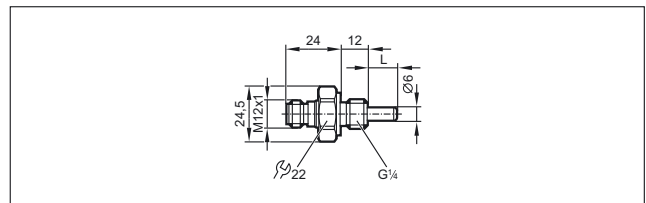

27

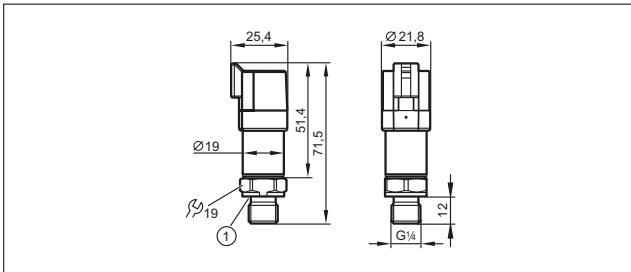

1: sealing FKM / DIN 3869

28

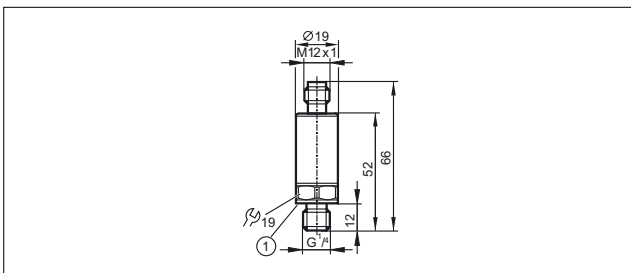

1: sealing

Scale drawings / drawing no. – CAD download: www.ifm.com

34

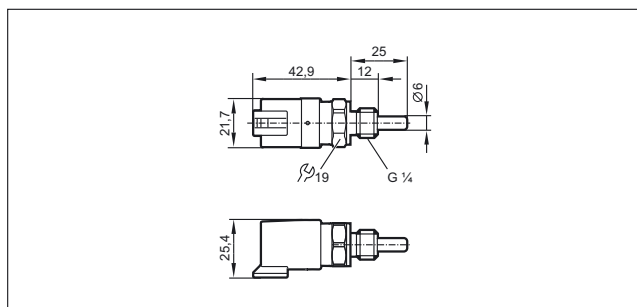



High-quality connectors for multiple applications



Connection technology

To match the large range of different sensor designs, ifm offers a great variety of high-quality connectors. The choice of types covers common M8, M12, M18 types through to valve plugs. The „ecolink“ connectors (order no. EVxxxx) offer additional quality features.

ecolink – a new dimension in connection technology

Due to the special installation of a mechanical end stop, the O-ring is always correctly compressed and so permanently maintains its sealing function. The connector remains securely positioned on the unit even in case of extreme vibration and impacts. The innovative design and a transparent black housing ensure that, even in bright lighting conditions, the LEDs are more clearly visible than with the clear transparent versions.

For industrial applications

High-quality materials suited to the requirements in industrial environments. Largely resistant to oils, fats and coolants.

For hygienic and wet areas

PVC housing and cable, gold-plated contacts and high-grade stainless steel nuts are the optimum choice for long life.

For hazardous areas





Connection technology for ATEX categories 1D, 2D, 3D and 1G, 3G. With the EC type examination certificate for components from DEKRA EXAM, the connection technology meets strictest requirements.

For welding applications

Halogen-free PUR cables prevent burning-in of weld spatter; teflon-coated coupling nuts prevent weld spatter sticking. The cables are also suited for drag chains and torsional movements.

For sensors in robust applications

The saw tooth contoured vibration protection secures against strong shocks and vibrations. The high protection rating, wide temperature range and high-quality housing materials (high-grade stainless steel, TPU) ensure permanent safe connection in harsh environments.

	Sockets	754 - 786
	Plugs	788 - 792
	Jumper cables	794 - 835
	Splitter boxes	836 - 855
	Y-splitters	856 - 860





Connection technology



Sockets







Sockets are mainly used for the connection of sensors. High-quality socket contacts and materials ensure reliable electrical connections.

In addition to a wide range of standard products ifm also offers versions without silicone and halogen, versions for hygienic areas, for applications in contact with coolants and lubricants, as well as for welding applications.

System overview	Page
M8 sockets for industrial applications	754 - 756
M12 sockets for industrial applications	756 - 761
M12 sockets for industrial applications with screen	761 - 763
M16 sockets for industrial applications	763
M18 sockets for industrial applications	763
M23 sockets for industrial applications	764 - 765
1/2" sockets for industrial applications	765 - 766
7/8" sockets for industrial applications	766
DIN sockets for industrial applications	766
RD24 sockets for industrial applications	766
Connectors weld slag resistant	767 - 768
Connectors for hygienic and wet areas	768 - 772
M12 cable sockets for hygienic and wet areas with screen	772 - 776
Connectors for hazardous areas	776 - 777
Connectors for robust applications	777 - 779
Wiring diagrams	780 - 781
Scale drawings / drawing no. – CAD download: www.ifm.com	782 - 786

M8 sockets for industrial applications

Type	Cable	Wire specification	Material housing / nut	U [V]	T _a [°C]	Protection	LEDs	Drawing no.	Order no.
Group 1 · Socket M8, 3-pole, 3-wire · Wiring diagram no. 1									
	2 m black PUR cable	3 x 0.25 mm ² , Ø 3.7 mm	TPU / Brass	50 AC 60 DC	-25...90	IP 65 / IP 67 / IP 68 / IP 69K	-	1	EVC141

Type	Cable	Wire specification	Material housing / nut	U [V]	T _a [°C]	Protection	LEDs	Drawing no.	Order no.
Group 1 · Socket M8, 3-pole, 3-wire · Wiring diagram no. 1									
	5 m black PUR cable	3 x 0.25 mm ² , Ø 3.7 mm	TPU / Brass	50 AC 60 DC	-25...90	IP 65 / IP 67 / IP 68 / IP 69K	–	1	EVC142
	10 m black PUR cable	3 x 0.25 mm ² , Ø 3.7 mm	TPU / Brass	50 AC 60 DC	-25...90	IP 65 / IP 67 / IP 68 / IP 69K	–	1	EVC143
	2 m black PUR cable	3 x 0.25 mm ² , Ø 3.7 mm	TPU / Brass	50 AC 60 DC	-25...90	IP 65 / IP 67 / IP 68 / IP 69K	–	2	EVC144
	5 m black PUR cable	3 x 0.25 mm ² , Ø 3.7 mm	TPU / Brass	50 AC 60 DC	-25...90	IP 65 / IP 67 / IP 68 / IP 69K	–	2	EVC145
	10 m black PUR cable	3 x 0.25 mm ² , Ø 3.7 mm	TPU / Brass	50 AC 60 DC	-25...90	IP 65 / IP 67 / IP 68 / IP 69K	–	2	EVC146
Group 2 · Socket M8, 3-pole, 3-wire, LED, PNP · Wiring diagram no. 2									
	2 m black PUR cable	3 x 0.25 mm ² , Ø 3.7 mm	TPU / Brass	10...36 DC	-25...90	IP 65 / IP 67 / IP 68 / IP 69K	green / yellow	3	EVC147
	5 m black PUR cable	3 x 0.25 mm ² , Ø 3.7 mm	TPU / Brass	10...36 DC	-25...90	IP 65 / IP 67 / IP 68 / IP 69K	green / yellow	3	EVC148
	10 m black PUR cable	3 x 0.25 mm ² , Ø 3.7 mm	TPU / Brass	10...36 DC	-25...90	IP 65 / IP 67 / IP 68 / IP 69K	green / yellow	3	EVC149
Group 3 · Wirable socket M8, 3-pole · Wiring diagram no. 3									
	wirable	–	PA / Brass	...45 AC ...70 DC	-25...90	IP 68	–	–	E11552
Group 4 · Socket M8, 4-pole, 4-wire · Wiring diagram no. 4									
	2 m black PUR cable	4 x 0.25 mm ² , Ø 3.7 mm	TPU / Brass	50 AC 60 DC	-25...90	IP 65 / IP 67 / IP 68 / IP 69K	–	4	EVC150
	5 m black PUR cable	4 x 0.25 mm ² , Ø 3.7 mm	TPU / Brass	50 AC 60 DC	-25...90	IP 65 / IP 67 / IP 68 / IP 69K	–	4	EVC151
	10 m black PUR cable	4 x 0.25 mm ² , Ø 3.7 mm	TPU / Brass	50 AC 60 DC	-25...90	IP 65 / IP 67 / IP 68 / IP 69K	–	4	EVC152
	2 m black PUR cable	4 x 0.25 mm ² , Ø 3.7 mm	TPU / Brass	50 AC 60 DC	-25...90	IP 65 / IP 67 / IP 68 / IP 69K	–	5	EVC153



Connection technology

Type	Cable	Wire specification	Material housing / nut	U [V]	T _a [°C]	Protection	LEDs	Drawing no.	Order no.
------	-------	--------------------	------------------------	-------	---------------------	------------	------	-------------	-----------

Group 4 · Socket M8, 4-pole, 4-wire · Wiring diagram no. 4

	5 m black PUR cable	4 x 0.25 mm ² , Ø 3.7 mm	TPU / Brass	50 AC 60 DC	-25...90	IP 65 / IP 67 / IP 68 / IP 69K	–	5	EVC154
	10 m black PUR cable	4 x 0.25 mm ² , Ø 3.7 mm	TPU / Brass	50 AC 60 DC	-25...90	IP 65 / IP 67 / IP 68 / IP 69K	–	5	EVC155



Group 5 · Wirable socket M8, 4-pole · Wiring diagram no. 5

	wirable	–	PA / Brass	...45 AC ...70 DC	-25...90	IP 68	–	–	E11553
---	---------	---	------------	----------------------	----------	-------	---	---	---------------

M12 sockets for industrial applications

Type	Cable	Wire specification	Material housing / nut	U [V]	T _a [°C]	Protection	LEDs	Drawing no.	Order no.
------	-------	--------------------	------------------------	-------	---------------------	------------	------	-------------	-----------

Group 6 · Socket M12, 5-pole, 2-wire · Wiring diagram no. 6

	2 m black PUR cable	2 x 0.34 mm ² , Ø 4.9 mm	TPU / Brass	250 AC 300 DC	-25...90	IP 65 / IP 67 / IP 68 / IP 69K	–	6	EVC164
	5 m black PUR cable	2 x 0.34 mm ² , Ø 4.9 mm	TPU / Brass	250 AC 300 DC	-25...90	IP 65 / IP 67 / IP 68 / IP 69K	–	6	EVC165
	10 m black PUR cable	2 x 0.34 mm ² , Ø 4.9 mm	TPU / Brass	250 AC 300 DC	-25...90	IP 65 / IP 67 / IP 68 / IP 69K	–	6	EVC166
	2 m black PUR cable	2 x 0.34 mm ² , Ø 4.9 mm	TPU / Brass	250 AC 300 DC	-25...90	IP 65 / IP 67 / IP 68 / IP 69K	–	7	EVC161
	5 m black PUR cable	2 x 0.34 mm ² , Ø 4.9 mm	TPU / Brass	250 AC 300 DC	-25...90	IP 65 / IP 67 / IP 68 / IP 69K	–	7	EVC162
	10 m black PUR cable	2 x 0.34 mm ² , Ø 4.9 mm	TPU / Brass	250 AC 300 DC	-25...90	IP 65 / IP 67 / IP 68 / IP 69K	–	7	EVC163

Group 7 · socket M12, 2-pole + PE, 3-wire · Wiring diagram no. 7







	2 m orange PVC cable	3 x AWG 22 (3 x 0.34 mm ²), Ø 5 mm	TPU / Brass	250 AC 300 DC	-25...90	IP 67	–	8	E10865
	5 m orange PVC cable	3 x AWG 22 (3 x 0.34 mm ²), Ø 5 mm	TPU / Brass	250 AC 300 DC	-25...90	IP 67	–	8	E10866
	2 m orange PVC cable	3 x AWG 22 (3 x 0.34 mm ²), Ø 5 mm	TPU / Brass	250 AC 300 DC	-25...90	IP 67	–	9	E10867

Type	Cable	Wire specification	Material housing / nut	U [V]	T _a [°C]	Protection	LEDs	Drawing no.	Order no.
Group 7 · socket M12, 2-pole + PE, 3-wire · Wiring diagram no. 7									
	5 m orange PVC cable	3 x AWG 22 (3 x 0.34 mm ²), Ø 5 mm	TPU / Brass	250 AC 300 DC	-25...90	IP 67	–	9	E10868
Group 8 · Wirable socket M12, 4-pole · Wiring diagram no. 5									
	wirable	...0.75 mm ² (Ø 4...6 mm)	PA / Brass	45 AC 70 DC	-25...85	IP 68	–	10	E11509
	wirable	...0.75 mm ² (Ø 4...6 mm)	PA / Brass	45 AC 70 DC	-25...85	IP 68	–	11	E11508
Group 9 · Wirable socket M12, 4-pole, LED, PNP · Wiring diagram no. 8									
	wirable	...0.75 mm ² (Ø 4...6 mm)	PA / Brass	10...30 DC	-25...85	IP 68	green / yellow	12	E11510
	wirable	...0.75 mm ² (Ø 4...6 mm)	PA	10...30 DC	-40...85	IP 67	green / yellow	11	E10136
Group 10 · Socket M12, 5/4-pole, 4-wire · Wiring diagram no. 4									
	2 m black PUR cable	4 x 0.34 mm ² , Ø 4.9 mm	TPU / Brass	250 AC 300 DC	-25...90	IP 65 / IP 67 / IP 68 / IP 69K	–	6	EVC004
	5 m black PUR cable	4 x 0.34 mm ² , Ø 4.9 mm	TPU / Brass	250 AC 300 DC	-25...90	IP 65 / IP 67 / IP 68 / IP 69K	–	6	EVC005
	10 m black PUR cable	4 x 0.34 mm ² , Ø 4.9 mm	TPU / Brass	250 AC 300 DC	-25...90	IP 65 / IP 67 / IP 68 / IP 69K	–	6	EVC006
	2 m black PUR cable	4 x 0.34 mm ² , Ø 4.9 mm	TPU / Brass	250 AC 300 DC	-25...90	IP 65 / IP 67 / IP 68 / IP 69K	–	7	EVC001
	5 m black PUR cable	4 x 0.34 mm ² , Ø 4.9 mm	TPU / Brass	250 AC 300 DC	-25...90	IP 65 / IP 67 / IP 68 / IP 69K	–	7	EVC002
	10 m black PUR cable	4 x 0.34 mm ² , Ø 4.9 mm	TPU / Brass	250 AC 300 DC	-25...90	IP 65 / IP 67 / IP 68 / IP 69K	–	7	EVC003
Group 11 · Socket M12, 5/4-pole, 4-wire, LED, PNP · Wiring diagram no. 9									
	2 m black PUR cable	4 x 0.34 mm ² , Ø 4.9 mm	TPU / Brass	10...36 DC	-25...90	IP 65 / IP 67 / IP 68 / IP 69K	green / 2 x yellow	13	EVC007
	5 m black PUR cable	4 x 0.34 mm ² , Ø 4.9 mm	TPU / Brass	10...36 DC	-25...90	IP 65 / IP 67 / IP 68 / IP 69K	green / 2 x yellow	13	EVC008

You can find wiring diagrams and scale drawings from page 780



Connection technology

Type	Cable	Wire specification	Material housing / nut	U [V]	T _a [°C]	Protection	LEDs	Drawing no.	Order no.
Group 11 · Socket M12, 5/4-pole, 4-wire, LED, PNP · Wiring diagram no. 9									
	10 m black PUR cable	4 x 0.34 mm ² , Ø 4.9 mm	TPU / Brass	10...36 DC	-25...90	IP 65 / IP 67 / IP 68 / IP 69K	green / 2 x yellow	13	EVC009
Group 12 · Wirable socket M12, 5-pole · Wiring diagram no. 10									
	wirable	...0.75 mm ² (Ø 4...6 mm)	PA / Brass	45 AC 70 DC	-25...85	IP 68	–	14	E11512
	wirable	...0.75 mm ² (Ø 4...6 mm)	PA / Brass	125 AC/DC	-25...85	IP 68	–	15	E11511
Group 13 · Socket M12, 5-pole, 5-wire · Wiring diagram no. 11									
	2 m black PUR cable	5 x 0.34 mm ² , Ø 4.9 mm	TPU / Brass	60 AC 60 DC	-25...90	IP 65 / IP 67 / IP 68 / IP 69K	–	6	EVC073
	5 m black PUR cable	5 x 0.34 mm ² , Ø 4.9 mm	TPU / Brass	60 AC 60 DC	-25...90	IP 65 / IP 67 / IP 68 / IP 69K	–	6	EVC074
	10 m black PUR cable	5 x 0.34 mm ² , Ø 4.9 mm	TPU / Brass	60 AC 60 DC	-25...90	IP 65 / IP 67 / IP 68 / IP 69K	–	6	EVC075
	2 m black PUR cable	5 x 0.34 mm ² , Ø 4.9 mm	TPU / Brass	60 AC 60 DC	-25...90	IP 65 / IP 67 / IP 68 / IP 69K	–	7	EVC070
	5 m black PUR cable	5 x 0.34 mm ² , Ø 4.9 mm	TPU / Brass	60 AC 60 DC	-25...90	IP 65 / IP 67 / IP 68 / IP 69K	–	7	EVC071
	10 m black PUR cable	5 x 0.34 mm ² , Ø 4.9 mm	TPU / Brass	60 AC 60 DC	-25...90	IP 65 / IP 67 / IP 68 / IP 69K	–	7	EVC072
Group 14 · Socket M12, 8-pole, 6-wire · Wiring diagram no. 12									
	5 m black PUR cable	6 x 0.34 mm ² , Ø 6 mm	TPU / diecast zinc	60 AC/DC	-25...85	IP 68	–	16	E10976
	10 m black PUR cable	6 x 0.34 mm ² , Ø 6 mm	TPU / diecast zinc	60 AC/DC	-25...85	IP 68	–	16	E10977
Group 15 · socket M12, 8-pole, 7-wire + screen · Wiring diagram no. 13									
	2 m black PUR cable	7 x 0.25 mm ² + screen	TPU / diecast zinc	60 AC/DC	-25...85	IP 67	–	16	E20738
	5 m black PUR cable	7 x 0.25 mm ² + screen	TPU / diecast zinc	60 AC/DC	-25...85	IP 67	–	16	E20838

Type	Cable	Wire specification	Material housing / nut	U [V]	T _a [°C]	Protection	LEDs	Drawing no.	Order no.
Group 16 · Socket M12, 8/7-pole, 8-wire · Wiring diagram no. 14									
	2 m black PUR cable	8 x 0.25 mm ² , Ø 6.2 mm	PUR / Brass	30 AC 36 DC	-25...80	IP 67	–	17	E11231
	5 m black PUR cable	8 x 0.25 mm ² , Ø 6.2 mm	PUR / Brass	30 AC 36 DC	-25...80	IP 67	–	17	E11232
	2 m black PUR cable	8 x 0.25 mm ² , Ø 6.2 mm	PUR / Brass	30 AC 36 DC	-25...80	IP 68	–	18	E11950
	5 m black PUR cable	8 x 0.25 mm ² , Ø 6.2 mm	PUR / Brass	30 AC 36 DC	-25...80	IP 68	–	18	E11807
	10 m black PUR cable	8 x 0.25 mm ² , Ø 6.2 mm	PUR / Brass	30 AC 36 DC	-25...80	IP 68	–	18	E11311
Group 17 · Socket M12, 8/7-pole, 8-wire · Wiring diagram no. 15									
	5 m black PUR cable	8 x 0.25 mm ²	TPU / Brass	30 AC 36 DC	-40...80	IP 68	–	17	E12168
	10 m black PUR cable	8 x 0.25 mm ²	TPU / Brass	30 AC 36 DC	-40...80	IP 68	–	17	E12169
	5 m black PUR cable	8 x 0.25 mm ²	TPU / Brass	30 AC 36 DC	-40...80	IP 67	–	18	E12166
	10 m black PUR cable	8 x 0.25 mm ²	TPU / Brass	30 AC 36 DC	-40...80	IP 67	–	18	E12167
Group 18 · Socket M12, 5/4-pole, 4-wire, LED, PNP · Wiring diagram no. 16									
	2 m black PUR cable	4 x 0.34 mm ² , Ø 4.9 mm	TPU / Brass	10...36 DC	-25...90	IP 65 / IP 67 / IP 68 / IP 69K	2 x green / 4 x yellow	19	EVC644
	5 m black PUR cable	4 x 0.34 mm ² , Ø 4.9 mm	TPU / Brass	10...36 DC	-25...90	IP 65 / IP 67 / IP 68 / IP 69K	2 x green / 4 x yellow	19	EVC645
	10 m black PUR cable	4 x 0.34 mm ² , Ø 4.9 mm	TPU / Brass	10...36 DC	-25...90	IP 65 / IP 67 / IP 68 / IP 69K	2 x green / 4 x yellow	19	EVC646
Group 19 · Socket M12, 5/4-pole, 4-wire · Wiring diagram no. 4									
	2 m black PUR cable	4 x 1.00 mm ² , Ø 6.2 mm	TPU / Brass	250 AC 300 DC	-25...90	IP 65 / IP 67 / IP 68 / IP 69K	–	7	EVC706



Connection technology

Type	Cable	Wire specification	Material housing / nut	U [V]	T _a [°C]	Protection	LEDs	Drawing no.	Order no.
Group 19 · Socket M12, 5/4-pole, 4-wire · Wiring diagram no. 4									
	5 m black PUR cable	4 x 1.00 mm ² , Ø 6.2 mm	TPU / Brass	250 AC 300 DC	-25...90	IP 65 / IP 67 / IP 68 / IP 69K	–	7	EVC707
	10 m black PUR cable	4 x 1.00 mm ² , Ø 6.2 mm	TPU / Brass	250 AC 300 DC	-25...90	IP 65 / IP 67 / IP 68 / IP 69K	–	7	EVC708
	20 m black PUR cable	4 x 1.00 mm ² , Ø 6.2 mm	TPU / Brass	250 AC 300 DC	-25...90	IP 65 / IP 67 / IP 68 / IP 69K	–	7	EVC709
	50 m black PUR cable	4 x 1.00 mm ² , Ø 6.2 mm	TPU / Brass	250 AC 300 DC	-25...90	IP 65 / IP 67 / IP 68 / IP 69K	–	7	EVC710
	2 m black PUR cable	4 x 1.00 mm ² , Ø 6.2 mm	TPU / Brass	250 AC 300 DC	-25...90	IP 65 / IP 67 / IP 68 / IP 69K	–	6	EVC711
	5 m black PUR cable	4 x 1.00 mm ² , Ø 6.2 mm	TPU / Brass	250 AC 300 DC	-25...90	IP 65 / IP 67 / IP 68 / IP 69K	–	6	EVC712
	10 m black PUR cable	4 x 1.00 mm ² , Ø 6.2 mm	TPU / Brass	250 AC 300 DC	-25...90	IP 65 / IP 67 / IP 68 / IP 69K	–	6	EVC713
	20 m black PUR cable	4 x 1.00 mm ² , Ø 6.2 mm	TPU / Brass	250 AC 300 DC	-25...90	IP 65 / IP 67 / IP 68 / IP 69K	–	6	EVC714
	50 m black PUR cable	4 x 1.00 mm ² , Ø 6.2 mm	TPU / Brass	250 AC 300 DC	-25...90	IP 65 / IP 67 / IP 68 / IP 69K	–	6	EVC715
Group 20 · Socket M12, 12-pole, 12-wire · Wiring diagram no. 17									
	5 m black PUR cable	12 x 0.25 mm ² , Ø 6.6 mm	PUR / diecast zinc	30 AC/DC	-25...90	IP 67	–	20	E12457
	10 m black PUR cable	12 x 0.25 mm ² , Ø 6.6 mm	PUR / diecast zinc	30 AC/DC	-25...90	IP 67	–	20	E12505
	15 m black PUR cable	12 x 0.25 mm ² , Ø 6.6 mm	PUR / diecast zinc	30 AC/DC	-25...90	IP 67	–	20	E12506
	5 m black PUR cable	12 x 0.25 mm ² , Ø 6.6 mm	PUR / diecast zinc	30 AC/DC	-25...90	IP 67	–	21	E12502
	10 m black PUR cable	12 x 0.25 mm ² , Ø 6.6 mm	PUR / diecast zinc	30 AC/DC	-25...90	IP 67	–	21	E12503

Type	Cable	Wire specification	Material housing / nut	U [V]	T _a [°C]	Protection	LEDs	Drawing no.	Order no.
------	-------	--------------------	------------------------	-------	---------------------	------------	------	-------------	-----------

Group 20 · Socket M12, 12-pole, 12-wire · Wiring diagram no. 17

	15 m black PUR cable	12 x 0.25 mm ² , Ø 6.6 mm	PUR / diecast zinc	30 AC/DC	-25...90	IP 67	–	21	E12504
---	----------------------	--------------------------------------	--------------------	----------	----------	-------	---	----	--------



M12 sockets for industrial applications with screen

Type	Cable	Wire specification	Material housing / nut	U [V]	T _a [°C]	Protection	LEDs	Drawing no.	Order no.
------	-------	--------------------	------------------------	-------	---------------------	------------	------	-------------	-----------

Group 21 · Socket M12, halogen-free, screened, screen not connected to the socket, 5/4-pole, 4-wire · Wiring diagram no. 18

	2 m black PUR cable	4 x 0.34 mm ² , Ø 4.9 mm	TPU / Brass	50 AC 60 DC	-25...90	IP 65 / IP 67 / IP 68 / IP 69K	–	7	EVC526
	5 m black PUR cable	4 x 0.34 mm ² , Ø 4.9 mm	TPU / Brass	50 AC 60 DC	-25...90	IP 65 / IP 67 / IP 68 / IP 69K	–	7	EVC527
	10 m black PUR cable	4 x 0.34 mm ² , Ø 4.9 mm	TPU / Brass	50 AC 60 DC	-25...90	IP 65 / IP 67 / IP 68 / IP 69K	–	7	EVC528
	2 m black PUR cable	4 x 0.34 mm ² , Ø 4.9 mm	TPU / Brass	50 AC 60 DC	-25...90	IP 65 / IP 67 / IP 68 / IP 69K	–	6	EVC529
	5 m black PUR cable	4 x 0.34 mm ² , Ø 4.9 mm	TPU / Brass	50 AC 60 DC	-25...90	IP 65 / IP 67 / IP 68 / IP 69K	–	6	EVC530
	10 m black PUR cable	4 x 0.34 mm ² , Ø 4.9 mm	TPU / Brass	50 AC 60 DC	-25...90	IP 65 / IP 67 / IP 68 / IP 69K	–	6	EVC531



Group 22 · Socket M12, halogen-free, screened, screen not connected to the socket, 5-pole, 5-wire · Wiring diagram no. 19

	2 m black PUR cable	5 x 0.25 mm ² , Ø 4.9 mm	TPU / Brass	30 AC 36 DC	-25...90	IP 65 / IP 67 / IP 68 / IP 69K	–	7	EVC532
	5 m black PUR cable	5 x 0.25 mm ² , Ø 4.9 mm	TPU / Brass	30 AC 36 DC	-25...90	IP 65 / IP 67 / IP 68 / IP 69K	–	7	EVC533
	10 m black PUR cable	5 x 0.25 mm ² , Ø 4.9 mm	TPU / Brass	30 AC 36 DC	-25...90	IP 65 / IP 67 / IP 68 / IP 69K	–	7	EVC534
	2 m black PUR cable	5 x 0.25 mm ² , Ø 4.9 mm	TPU / Brass	30 AC 36 DC	-25...90	IP 65 / IP 67 / IP 68 / IP 69K	–	6	EVC535
	5 m black PUR cable	5 x 0.25 mm ² , Ø 4.9 mm	TPU / Brass	30 AC 36 DC	-25...90	IP 65 / IP 67 / IP 68 / IP 69K	–	6	EVC536



Connection technology

Type	Cable	Wire specification	Material housing / nut	U [V]	T _a [°C]	Protection	LEDs	Drawing no.	Order no.
Group 22 · Socket M12, halogen-free, screened, screen not connected to the socket, 5-pole, 5-wire · Wiring diagram no. 19									
	10 m black PUR cable	5 x 0.25 mm ² , Ø 4.9 mm	TPU / Brass	30 AC 36 DC	-25...90	IP 65 / IP 67 / IP 68 / IP 69K	–	6	EVC537
Group 23 · Socket M12, halogen-free, screened, screen connected to the socket, 5/4-pole, 4-wire · Wiring diagram no. 20									
	2 m black PUR cable	4 x 0.34 mm ² , Ø 4.9 mm	TPU / Brass	50 AC 60 DC	-25...90	IP 65 / IP 67	–	7	EVC538
	5 m black PUR cable	4 x 0.34 mm ² , Ø 4.9 mm	TPU / Brass	50 AC 60 DC	-25...90	IP 65 / IP 67	–	7	EVC539
	10 m black PUR cable	4 x 0.34 mm ² , Ø 4.9 mm	TPU / Brass	50 AC 60 DC	-25...90	IP 65 / IP 67	–	7	EVC540
	2 m black PUR cable	4 x 0.34 mm ² , Ø 4.9 mm	TPU / Brass	50 AC 60 DC	-25...90	IP 65 / IP 67	–	6	EVC541
	5 m black PUR cable	4 x 0.34 mm ² , Ø 4.9 mm	TPU / Brass	50 AC 60 DC	-25...90	IP 65 / IP 67	–	6	EVC542
	10 m black PUR cable	4 x 0.34 mm ² , Ø 4.9 mm	TPU / Brass	50 AC 60 DC	-25...90	IP 65 / IP 67	–	6	EVC543
Group 24 · Socket M12, halogen-free, screened, screen connected to the socket, 5-pole, 5-wire · Wiring diagram no. 21									
	2 m black PUR cable	5 x 0.25 mm ² , Ø 4.9 mm	TPU / Brass	30 AC 36 DC	-25...90	IP 65 / IP 67	–	7	EVC544
	5 m black PUR cable	5 x 0.25 mm ² , Ø 4.9 mm	TPU / Brass	30 AC 36 DC	-25...90	IP 65 / IP 67	–	7	EVC545
	10 m black PUR cable	5 x 0.25 mm ² , Ø 4.9 mm	TPU / Brass	30 AC 36 DC	-25...90	IP 65 / IP 67	–	7	EVC546
	2 m black PUR cable	5 x 0.25 mm ² , Ø 4.9 mm	TPU / Brass	30 AC 36 DC	-25...90	IP 65 / IP 67	–	6	EVC547
	5 m black PUR cable	5 x 0.25 mm ² , Ø 4.9 mm	TPU / Brass	30 AC 36 DC	-25...90	IP 65 / IP 67	–	6	EVC548
	10 m black PUR cable	5 x 0.25 mm ² , Ø 4.9 mm	TPU / Brass	30 AC 36 DC	-25...90	IP 65 / IP 67	–	6	EVC549

Type	Cable	Wire specification	Material housing / nut	U [V]	T _a [°C]	Protection	LEDs	Drawing no.	Order no.
Group 25 · Socket M12, halogen-free, screened, screen not connected to the socket, 4-pole, 4-wire · Wiring diagram no. 18									
	5 m black PUR cable	4 x 0.34 mm ² , Ø 5 mm	TPU / Brass	50 AC 60 DC	-25...85	IP 67	–	22	E12339
	10 m black PUR cable	4 x 0.34 mm ² , Ø 5 mm	TPU / Brass	50 AC 60 DC	-40...85	IP 67	–	22	E12340



M16 sockets for industrial applications

Type	Cable	Wire specification	Material housing / nut	U [V]	T _a [°C]	Protection	LEDs	Drawing no.	Order no.
Group 26 · socket M16, 14-pole, 10-wire · Wiring diagram no. 22									
	5 m black PUR cable	8 x 0.34 mm ² + 2 x 0.75 mm ² , Ø 9.2 mm	PUR / Brass	30 DC	-25...80	IP 67	–	23	E11226
	10 m black PUR cable	8 x 0.34 mm ² + 2 x 0.75 mm ² , Ø 10 mm	PUR / Brass	30 DC	-25...80	IP 67	–	23	E11227

Group 27 · Socket M16, 14-pole, 12-wire · Wiring diagram no. 23

	2 m black PUR cable	2 x 0.34 mm ² + 9 x 0.25 mm ² , Ø 7.5 mm	PUR / Brass	30 DC	-25...90	IP 67	–	24	E11645
	5 m black PUR cable	2 x 0.34 mm ² + 9 x 0.25 mm ² , Ø 7.5 mm	PUR / Brass	30 DC	-25...90	IP 67	–	24	E11697

M18 sockets for industrial applications

Type	Cable	Wire specification	Material housing / nut	U [V]	T _a [°C]	Protection	LEDs	Drawing no.	Order no.
Group 28 · Wirable socket M18, 4-pole · Wiring diagram no. 5									
	wirable	...0.75 mm ² (Ø 6...8 mm)	PA	20...250 AC/DC	-40...85	IP 65	–	25	E10013
	wirable	...0.75 mm ² (Ø 6...8 mm)	PA / ULTRAMID	20...250 AC/DC	-40...85	IP 65	–	26	E10137



Connection technology

M23 sockets for industrial applications

Type	Cable	Wire specification	Material housing / nut	U [V]	T _a [°C]	Protection	LEDs	Drawing no.	Order no.
Group 29 · Socket M23, 12-pole, 12-wire · Wiring diagram no. 24									
	5 m black PUR cable	8 x 0.5 mm ² + 3 x 1.0 mm ² , Ø 9.3 mm	PUR / Brass	63 AC/DC	-25...80	IP 67	–	27	E11739
	10 m black PUR cable	8 x 0.5 mm ² + 3 x 1.0 mm ² , Ø 9.3 mm	PUR / Brass	63 AC/DC	-25...80	IP 67	–	27	E11740
	15 m black PUR cable	8 x 0.5 mm ² + 3 x 1.0 mm ² , Ø 9.3 mm	PUR / Brass	63 AC/DC	-25...80	IP 67	–	27	E11741
	5 m black PUR cable	8 x 0.5 mm ² + 3 x 1.0 mm ² , Ø 9.3 mm	PUR / Brass	63 AC/DC	-25...80	IP 67	–	28	E11736
	10 m black PUR cable	8 x 0.5 mm ² + 3 x 1.0 mm ² , Ø 9.3 mm	PUR / Brass	63 AC/DC	-25...80	IP 67	–	28	E11737
	15 m black PUR cable	8 x 0.5 mm ² + 3 x 1.0 mm ² , Ø 9.3 mm	PUR / Brass	63 AC/DC	-25...80	IP 67	–	28	E11738
Group 30 · Wirable M23 socket, 12 poles									
	wirable	...1 mm ² (Ø 10...14 mm)	Brass	10...30 DC	-25...90	IP 65	–	29	E10448
	wirable	...1 mm ² (Ø 10...14 mm)	Brass	10...30 DC	-25...90	IP 65	–	30	E10447
Group 31 · Socket M23, 19-pole, 19-wire · Wiring diagram no. 34									
	5 m black PUR cable	16 x 0.5 mm ² + 3 x 1.0 mm ² , Ø 11.6 mm	PUR / Brass	63 AC/DC	-25...80	IP 67	–	31	E11745
	10 m black PUR cable	16 x 0.5 mm ² + 3 x 1.0 mm ² , Ø 11.6 mm	PUR / Brass	63 AC/DC	-25...80	IP 67	–	31	E11746
	15 m black PUR cable	16 x 0.5 mm ² + 3 x 1.0 mm ² , Ø 11.6 mm	PUR / Brass	63 AC/DC	-25...80	IP 67	–	31	E11747
	5 m black PUR cable	16 x 0.5 mm ² + 3 x 1.0 mm ² , Ø 11.6 mm	PUR / Brass	63 AC/DC	-25...80	IP 67	–	32	E11742
	10 m black PUR cable	16 x 0.5 mm ² + 3 x 1.0 mm ² , Ø 11.6 mm	PUR / Brass	63 AC/DC	-25...80	IP 67	–	32	E11743

Type	Cable	Wire specification	Material housing / nut	U [V]	T _a [°C]	Protection	LEDs	Drawing no.	Order no.
------	-------	--------------------	------------------------	-------	---------------------	------------	------	-------------	-----------

Group 31 · Socket M23, 19-pole, 19-wire · Wiring diagram no. 34

	15 m black PUR cable	16 x 0.5 mm ² + 3 x 1.0 mm ² , Ø 11.6 mm	PUR / Brass	63 AC/DC	-25...80	IP 67	–	32	E11744
---	----------------------	--	-------------	----------	----------	-------	---	----	--------

Group 32 · Wirable socket M23, 19-pole



	wirable	...1 mm ² (Ø 10...14 mm)	Brass	10...30 DC	-25...90	IP 65	–	–	E10887
---	---------	-------------------------------------	-------	------------	----------	-------	---	---	--------



	wirable	...1 mm ² (Ø 10...14 mm)	Brass	10...30 DC	-25...90	IP 65	–	–	E10886
---	---------	-------------------------------------	-------	------------	----------	-------	---	---	--------

1/2" sockets for industrial applications

Type	Cable	Wire specification	Material housing / nut	U [V]	T _a [°C]	Protection	LEDs	Drawing no.	Order no.
------	-------	--------------------	------------------------	-------	---------------------	------------	------	-------------	-----------



Group 33 · socket 1/2", 2-pole + PE, 3-wire · Wiring diagram no. 25

	2 m yellow PVC cable	3 x AWG 22, Ø 5.2 mm	TPU / Brass	250 AC 300 DC	-25...90	IP 67	–	33	E10190
	5 m yellow PVC cable	3 x AWG 22, Ø 5.2 mm	TPU / Brass	250 AC 300 DC	-25...90	IP 67	–	33	E10200

	2 m yellow PVC cable	3 x AWG 22, Ø 5.2 mm	TPU / Brass	250 AC 300 DC	-25...90	IP 67	–	34	E10189
	5 m yellow PVC cable	3 x AWG 22, Ø 5.2 mm	TPU / Brass	250 AC 300 DC	-25...90	IP 67	–	34	E10191

	10 m yellow PVC cable	3 x AWG 22, Ø 5.2 mm	TPU / Brass	250 AC 300 DC	-25...90	IP 67	–	33	E10261
---	-----------------------	----------------------	-------------	------------------	----------	-------	---	----	--------

Group 34 · socket 1/2", 5-pole, 4-wire · Wiring diagram no. 26

	5 m black PUR cable	4 x 0.34 mm ² , Ø 4.7 mm	TPU / Brass	300 AC	-25...90	IP 67	–	35	E11248
	10 m black PUR cable	4 x 0.34 mm ² , Ø 4.7 mm	TPU / Brass	300 AC	-25...90	IP 67	–	35	E11249

	5 m black PUR cable	4 x 0.34 mm ² , Ø 4.7 mm	TPU / Brass	300 AC	-25...90	IP 67	–	36	E11250
--	---------------------	-------------------------------------	-------------	--------	----------	-------	---	----	--------



Connection technology

Type	Cable	Wire specification	Material housing / nut	U [V]	T _a [°C]	Protection	LEDs	Drawing no.	Order no.
------	-------	--------------------	------------------------	-------	---------------------	------------	------	-------------	-----------

Group 34 · socket 1/2", 5-pole, 4-wire · Wiring diagram no. 26

	10 m black PUR cable	4 x 0.34 mm ² , Ø 4.7 mm	TPU / Brass	300 AC	-25...90	IP 67	–	36	E11251
---	----------------------	-------------------------------------	-------------	--------	----------	-------	---	----	--------

7/8" sockets for industrial applications

Type	Cable	Wire specification	Material housing / nut	U [V]	T _a [°C]	Protection	LEDs	Drawing no.	Order no.
------	-------	--------------------	------------------------	-------	---------------------	------------	------	-------------	-----------

Group 35 · socket 7/8", 2-pole + PE, 3-wire

	2 m black PVC cable	3 x 0.75 mm ² , Ø 5.2 mm	TPU / diecast zinc	250 AC	-40...80	IP 68	–	37	E20428
---	---------------------	-------------------------------------	--------------------	--------	----------	-------	---	----	--------

Group 36 · socket 7/8", 3-pole, 3-wire

	2 m black PVC cable	3 x 0.5 mm ² , Ø 5.4 mm	TPU	10...30 DC	-40...80	IP 68	–	37	E20430
--	---------------------	------------------------------------	-----	------------	----------	-------	---	----	--------

DIN sockets for industrial applications

Type	Cable	Wire specification	Material housing / nut	U [V]	T _a [°C]	Protection	LEDs	Drawing no.	Order no.
------	-------	--------------------	------------------------	-------	---------------------	------------	------	-------------	-----------



Group 37 · socket DIN A (DIN EN 175301-803) · Wiring diagram no. 27

	wirable	...1.5 mm ² (Ø 6...8 mm)	PA	45 AC 70 DC	-40...125	IP 65	–	38	E10058
---	---------	-------------------------------------	----	----------------	-----------	-------	---	----	--------

RD24 sockets for industrial applications

Type	Cable	Wire specification	Material housing / nut	U [V]	T _a [°C]	Protection	LEDs	Drawing no.	Order no.
------	-------	--------------------	------------------------	-------	---------------------	------------	------	-------------	-----------

Group 38 · socket Rd24, 6-pole + PE · Wiring diagram no. 28

	wirable	...2.5 mm ² (Ø 10...12 mm)	PBT	250 AC 300 DC	-40...100	IP 67	–	39	E70142
	wirable	...2.5 mm ² (Ø 6...8 mm)	PBT / PA	250 AC 300 DC	-40...100	IP 67	–	40	E11043

Connectors weld slag resistant

Type	Cable	Wire specification	Material housing / nut	U [V]	T _a [°C]	Protection	LEDs	Drawing no.	Order no.
Group 137 · Socket M12, 5/4-pole, 4-wire · Wiring diagram no. 4									
	2 m grey PUR cable	4 x 0.34 mm ² , Ø 4.9 mm	TPU / Brass	250 AC 300 DC	-25...90	IP 65 / IP 67 / IP 68 / IP 69K	–	6	EVW004
	5 m grey PUR cable	4 x 0.34 mm ² , Ø 4.9 mm	TPU / Brass	250 AC 300 DC	-25...90	IP 65 / IP 67 / IP 68 / IP 69K	–	6	EVW005
	10 m grey PUR cable	4 x 0.34 mm ² , Ø 4.9 mm	TPU / Brass	250 AC 300 DC	-25...90	IP 65 / IP 67 / IP 68 / IP 69K	–	6	EVW006
	2 m grey PUR cable	4 x 0.34 mm ² , Ø 4.9 mm	TPU / Brass	250 AC 300 DC	-25...90	IP 65 / IP 67 / IP 68 / IP 69K	–	7	EVW001
	5 m grey PUR cable	4 x 0.34 mm ² , Ø 4.9 mm	TPU / Brass	250 AC 300 DC	-25...90	IP 65 / IP 67 / IP 68 / IP 69K	–	7	EVW002
	10 m grey PUR cable	4 x 0.34 mm ² , Ø 4.9 mm	TPU / Brass	250 AC 300 DC	-25...90	IP 65 / IP 67 / IP 68 / IP 69K	–	7	EVW003
Group 138 · Socket M12, 5/4-pole, 4-wire, LED, PNP · Wiring diagram no. 9									
	2 m grey PUR cable	4 x 0.34 mm ² , Ø 4.9 mm	TPU / Brass	10...36 DC	-25...90	IP 65 / IP 67 / IP 68 / IP 69K	green / 2 x yellow	13	EVW007
	5 m grey PUR cable	4 x 0.34 mm ² , Ø 4.9 mm	TPU / Brass	10...36 DC	-25...90	IP 65 / IP 67 / IP 68 / IP 69K	green / 2 x yellow	13	EVW008
	10 m grey PUR cable	4 x 0.34 mm ² , Ø 4.9 mm	TPU / Brass	10...36 DC	-25...90	IP 65 / IP 67 / IP 68 / IP 69K	green / 2 x yellow	13	EVW009
Group 139 · Socket M12, 5/4-pole, 4-wire, LED, PNP · Wiring diagram no. 29									
	2 m grey PUR cable	4 x 0.34 mm ² , Ø 4.9 mm	TPU / Brass	10...36 DC	-25...90	IP 65 / IP 67 / IP 68 / IP 69K	2 x green / 4 x yellow	19	EVW167
	5 m grey PUR cable	4 x 0.34 mm ² , Ø 4.9 mm	TPU / Brass	10...36 DC	-25...90	IP 65 / IP 67 / IP 68 / IP 69K	2 x green / 4 x yellow	19	EVW168
	10 m grey PUR cable	4 x 0.34 mm ² , Ø 4.9 mm	TPU / Brass	10...36 DC	-25...90	IP 65 / IP 67 / IP 68 / IP 69K	2 x green / 4 x yellow	19	EVW169



Connection technology

Type	Cable	Wire specification	Material housing / nut	U [V]	T _a [°C]	Protection	LEDs	Drawing no.	Order no.
------	-------	--------------------	------------------------	-------	---------------------	------------	------	-------------	-----------

Group 140 · Socket M12, 5/4-pole, 5-wire · Wiring diagram no. 11

	2 m grey PUR cable	5 x 0.34 mm ² , Ø 5.1 mm	TPU / Brass	60 AC 60 DC	-25...90	IP 65 / IP 67 / IP 68 / IP 69K	-	6	EVW013
	5 m grey PUR cable	5 x 0.34 mm ² , Ø 5.1 mm	TPU / Brass	60 AC 60 DC	-25...90	IP 65 / IP 67 / IP 68 / IP 69K	-	6	EVW014
	10 m grey PUR cable	5 x 0.34 mm ² , Ø 5.1 mm	TPU / Brass	60 AC 60 DC	-25...90	IP 65 / IP 67 / IP 68 / IP 69K	-	6	EVW015

Group 141 · Socket M12, 5/4-pole, 5-wire · Wiring diagram no. 11



	2 m grey PUR cable	5 x 0.34 mm ² , Ø 5.1 mm	TPU / Brass	60 AC 60 DC	-25...90	IP 65 / IP 67 / IP 68 / IP 69K	-	7	EVW010
	5 m grey PUR cable	5 x 0.34 mm ² , Ø 5.1 mm	TPU / Brass	60 AC 60 DC	-25...90	IP 65 / IP 67 / IP 68 / IP 69K	-	7	EVW011
	10 m grey PUR cable	5 x 0.34 mm ² , Ø 5.1 mm	TPU / Brass	60 AC 60 DC	-25...90	IP 65 / IP 67 / IP 68 / IP 69K	-	7	EVW012

Connectors for hygienic and wet areas

Type	Cable	Wire specification	Material housing / nut	U [V]	T _a [°C]	Protection	LEDs	Drawing no.	Order no.
------	-------	--------------------	------------------------	-------	---------------------	------------	------	-------------	-----------

Group 145 · Socket M8, 3-pole, 3-wire · Wiring diagram no. 1









	2 m orange PVC cable	3 x 0.34 mm ² , Ø 4.9 mm	PVC / stainless steel 316L / 1.4404	50 AC 60 DC	-25...80	IP 65 / IP 67 / IP 68 / IP 69K	-	41	EVT122
	5 m orange PVC cable	3 x 0.34 mm ² , Ø 4.9 mm	PVC / stainless steel 316L / 1.4404	50 AC 60 DC	-25...80	IP 65 / IP 67 / IP 68 / IP 69K	-	41	EVT123
	10 m orange PVC cable	3 x 0.34 mm ² , Ø 4.9 mm	PVC / stainless steel 316L / 1.4404	50 AC 60 DC	-25...80	IP 65 / IP 67 / IP 68 / IP 69K	-	41	EVT124
	25 m orange PVC cable	3 x 0.34 mm ² , Ø 4.9 mm	PVC / stainless steel 316L / 1.4404	50 AC 60 DC	-25...80	IP 65 / IP 67 / IP 68 / IP 69K	-	41	EVT125
	2 m orange PVC cable	3 x 0.34 mm ² , Ø 4.9 mm	PVC / stainless steel 316L / 1.4404	50 AC 60 DC	-25...80	IP 65 / IP 67 / IP 68 / IP 69K	-	42	EVT126
	5 m orange PVC cable	3 x 0.34 mm ² , Ø 4.9 mm	PVC / stainless steel 316L / 1.4404	50 AC 60 DC	-25...80	IP 65 / IP 67 / IP 68 / IP 69K	-	42	EVT127

Type	Cable	Wire specification	Material housing / nut	U [V]	T _a [°C]	Protection	LEDs	Drawing no.	Order no.
Group 145 · Socket M8, 3-pole, 3-wire · Wiring diagram no. 1									
	10 m orange PVC cable	3 x 0.34 mm ² , Ø 4.9 mm	PVC / stainless steel 316L / 1.4404	50 AC 60 DC	-25...80	IP 65 / IP 67 / IP 68 / IP 69K	–	42	EVT128
	25 m orange PVC cable	3 x 0.34 mm ² , Ø 4.9 mm	PVC / stainless steel 316L / 1.4404	50 AC 60 DC	-25...80	IP 65 / IP 67 / IP 68 / IP 69K	–	42	EVT129
Group 146 · Socket M8, 3-pole, 3-wire, LED, PNP · Wiring diagram no. 2									
	2 m orange PVC cable	3 x 0.34 mm ² , Ø 4.9 mm	PVC / stainless steel 316L / 1.4404	10...36 DC	-25...80	IP 65 / IP 67 / IP 68 / IP 69K	green / yellow	43	EVT130
	5 m orange PVC cable	3 x 0.34 mm ² , Ø 4.9 mm	PVC / stainless steel 316L / 1.4404	10...36 DC	-25...80	IP 65 / IP 67 / IP 68 / IP 69K	green / yellow	43	EVT131
	10 m orange PVC cable	3 x 0.34 mm ² , Ø 4.9 mm	PVC / stainless steel 316L / 1.4404	10...36 DC	-25...80	IP 65 / IP 67 / IP 68 / IP 69K	green / yellow	43	EVT132
	25 m orange PVC cable	3 x 0.34 mm ² , Ø 4.9 mm	PVC / stainless steel 316L / 1.4404	10...36 DC	-25...80	IP 65 / IP 67 / IP 68 / IP 69K	green / yellow	43	EVT133
Group 147 · Socket M8, 4-pole, 4-wire · Wiring diagram no. 4									
	2 m orange PVC cable	4 x 0.34 mm ² , Ø 4.9 mm	PVC / stainless steel 316L / 1.4404	50 AC 60 DC	-25...80	IP 65 / IP 67 / IP 68 / IP 69K	–	44	EVT134
	5 m orange PVC cable	4 x 0.34 mm ² , Ø 4.9 mm	PVC / stainless steel 316L / 1.4404	50 AC 60 DC	-25...80	IP 65 / IP 67 / IP 68 / IP 69K	–	44	EVT135
	10 m orange PVC cable	4 x 0.34 mm ² , Ø 4.9 mm	PVC / stainless steel 316L / 1.4404	50 AC 60 DC	-25...80	IP 65 / IP 67 / IP 68 / IP 69K	–	44	EVT136
	25 m orange PVC cable	4 x 0.34 mm ² , Ø 4.9 mm	PVC / stainless steel 316L / 1.4404	50 AC 60 DC	-25...80	IP 65 / IP 67 / IP 68 / IP 69K	–	44	EVT137
	2 m orange PVC cable	4 x 0.34 mm ² , Ø 4.9 mm	PVC / stainless steel 316L / 1.4404	50 AC 60 DC	-25...80	IP 65 / IP 67 / IP 68 / IP 69K	–	45	EVT138
	5 m orange PVC cable	4 x 0.34 mm ² , Ø 4.9 mm	PVC / stainless steel 316L / 1.4404	50 AC 60 DC	-25...80	IP 65 / IP 67 / IP 68 / IP 69K	–	45	EVT139
	10 m orange PVC cable	4 x 0.34 mm ² , Ø 4.9 mm	PVC / stainless steel 316L / 1.4404	50 AC 60 DC	-25...80	IP 65 / IP 67 / IP 68 / IP 69K	–	45	EVT140
	25 m orange PVC cable	4 x 0.34 mm ² , Ø 4.9 mm	PVC / stainless steel 316L / 1.4404	50 AC 60 DC	-25...80	IP 65 / IP 67 / IP 68 / IP 69K	–	45	EVT141





Connection technology







Type	Cable	Wire specification	Material housing / nut	U [V]	T _a [°C]	Protection	LEDs	Drawing no.	Order no.
Group 148 · Socket M12, 5/4-pole, 4-wire · Wiring diagram no. 4									
	2 m orange PVC cable	4 x 0.34 mm ² , Ø 4.9 mm	PVC / stainless steel 316L / 1.4404	250 AC 300 DC	-25...100	IP 65 / IP 67 / IP 68 / IP 69K	–	46	EVT067
	5 m orange PVC cable	4 x 0.34 mm ² , Ø 4.9 mm	PVC / stainless steel 316L / 1.4404	250 AC 300 DC	-25...100	IP 65 / IP 67 / IP 68 / IP 69K	–	46	EVT004
	10 m orange PVC cable	4 x 0.34 mm ² , Ø 4.9 mm	PVC / stainless steel 316L / 1.4404	250 AC 300 DC	-25...100	IP 65 / IP 67 / IP 68 / IP 69K	–	46	EVT005
	25 m orange PVC cable	4 x 0.34 mm ² , Ø 4.9 mm	PVC / stainless steel 316L / 1.4404	250 AC 300 DC	-25...100	IP 65 / IP 67 / IP 68 / IP 69K	–	46	EVT006
	2 m orange PVC cable	4 x 0.34 mm ² , Ø 4.9 mm	PVC / stainless steel 316L / 1.4404	250 AC 300 DC	-25...100	IP 65 / IP 67 / IP 68 / IP 69K	–	47	EVT064
	5 m orange PVC cable	4 x 0.34 mm ² , Ø 4.9 mm	PVC / stainless steel 316L / 1.4404	250 AC 300 DC	-25...100	IP 65 / IP 67 / IP 68 / IP 69K	–	47	EVT001
	10 m orange PVC cable	4 x 0.34 mm ² , Ø 4.9 mm	PVC / stainless steel 316L / 1.4404	250 AC 300 DC	-25...100	IP 65 / IP 67 / IP 68 / IP 69K	–	47	EVT002
	25 m orange PVC cable	4 x 0.34 mm ² , Ø 4.9 mm	PVC / stainless steel 316L / 1.4404	250 AC 300 DC	-25...100	IP 65 / IP 67 / IP 68 / IP 69K	–	47	EVT003
Group 149 · Wirable socket M12, 4-pole · Wiring diagram no. 5									
	wirable	...0.75 mm ² (Ø 4...6 mm)	PA / high-grade st. steel	45 AC 70 DC	-25...85	IP 67	–	48	E11862
	wirable	...0.75 mm ² (Ø 4...6 mm)	PA / high-grade st. steel	45 AC 70 DC	-25...90	IP 67	–	49	E11861
Group 150 · Socket M12, 5/4-pole, 4-wire, LED, PNP · Wiring diagram no. 9									
	2 m orange PVC cable	4 x 0.34 mm ² , Ø 4.9 mm	PVC / stainless steel 316L / 1.4404	10...36 DC	-25...100	IP 65 / IP 67 / IP 68 / IP 69K	green / 2 x yellow	50	EVT069
	5 m orange PVC cable	4 x 0.34 mm ² , Ø 4.9 mm	PVC / stainless steel 316L / 1.4404	10...36 DC	-25...100	IP 65 / IP 67 / IP 68 / IP 69K	green / 2 x yellow	50	EVT007
	10 m orange PVC cable	4 x 0.34 mm ² , Ø 4.9 mm	PVC / stainless steel 316L / 1.4404	10...36 DC	-25...100	IP 65 / IP 67 / IP 68 / IP 69K	green / 2 x yellow	50	EVT008
	25 m orange PVC cable	4 x 0.34 mm ² , Ø 4.9 mm	PVC / stainless steel 316L / 1.4404	10...36 DC	-25...100	IP 65 / IP 67 / IP 68 / IP 69K	green / 2 x yellow	50	EVT009

Type	Cable	Wire specification	Material housing / nut	U [V]	T _a [°C]	Protection	LEDs	Drawing no.	Order no.
Group 151 · Wirable socket M12, 5/4-pole, LED, PNP · Wiring diagram no. 30									
	wirable	...0.75 mm ² (Ø 4...6 mm)	PBT / high-grade st. steel	10...30 DC	-25...85	IP 67 / IP 69K	green / yellow	51	E11863
Group 152 · Socket M12, 5-pole, 5-wire · Wiring diagram no. 11									
	5 m orange PVC cable	5 x 0.34 mm ² , Ø 5.1 mm	PVC / stainless steel 316L / 1.4404	60 AC 60 DC	-25...100	IP 65 / IP 67 / IP 68 / IP 69K	–	46	EVT013
	10 m orange PVC cable	5 x 0.34 mm ² , Ø 5.1 mm	PVC / stainless steel 316L / 1.4404	60 AC 60 DC	-25...100	IP 65 / IP 67 / IP 68 / IP 69K	–	46	EVT014
	25 m orange PVC cable	5 x 0.34 mm ² , Ø 5.1 mm	PVC / stainless steel 316L / 1.4404	60 AC 60 DC	-25...100	IP 65 / IP 67 / IP 68 / IP 69K	–	46	EVT015
	5 m orange PVC cable	5 x 0.34 mm ² , Ø 5.1 mm	PVC / stainless steel 316L / 1.4404	60 AC 60 DC	-25...100	IP 65 / IP 67 / IP 68 / IP 69K	–	47	EVT010
	10 m orange PVC cable	5 x 0.34 mm ² , Ø 5.1 mm	PVC / stainless steel 316L / 1.4404	60 AC 60 DC	-25...100	IP 65 / IP 67 / IP 68 / IP 69K	–	47	EVT011
	25 m orange PVC cable	5 x 0.34 mm ² , Ø 5.1 mm	PVC / stainless steel 316L / 1.4404	60 AC 60 DC	-25...100	IP 65 / IP 67 / IP 68 / IP 69K	–	47	EVT012
Group 153 · Socket M12, 5/4-pole, 4-wire · halogen-free · Wiring diagram no. 4									
	5 m grey MPPE cable	4 x 0.34 mm ² , Ø 4.9 mm	PP / stainless steel 316L / 1.4404	250 AC 300 DC	-25...100	IP 65 / IP 67 / IP 68 / IP 69K	–	47	EVF001
	10 m grey MPPE cable	4 x 0.34 mm ² , Ø 4.9 mm	PP / stainless steel 316L / 1.4404	250 AC 300 DC	-25...100	IP 65 / IP 67 / IP 68 / IP 69K	–	47	EVF002
	25 m grey MPPE cable	4 x 0.34 mm ² , Ø 4.9 mm	PP / stainless steel 316L / 1.4404	250 AC 300 DC	-25...100	IP 65 / IP 67 / IP 68 / IP 69K	–	47	EVF003
	5 m grey MPPE cable	4 x 0.34 mm ² , Ø 4.9 mm	PP / stainless steel 316L / 1.4404	250 AC 300 DC	-25...100	IP 65 / IP 67 / IP 68 / IP 69K	–	46	EVF004
	10 m grey MPPE cable	4 x 0.34 mm ² , Ø 4.9 mm	PP / stainless steel 316L / 1.4404	250 AC 300 DC	-25...100	IP 65 / IP 67 / IP 68 / IP 69K	–	46	EVF005
	25 m grey MPPE cable	4 x 0.34 mm ² , Ø 4.9 mm	PP / stainless steel 316L / 1.4404	250 AC 300 DC	-25...100	IP 65 / IP 67 / IP 68 / IP 69K	–	46	EVF006



Connection technology

Type	Cable	Wire specification	Material housing / nut	U [V]	T _a [°C]	Protection	LEDs	Drawing no.	Order no.
Group 154 · Socket M12, 5/4-pole, 4-wire, LED, PNP · halogen-free · Wiring diagram no. 9									
	5 m grey MPPE cable	4 x 0.34 mm ² , Ø 4.9 mm	PP / stainless steel 316L / 1.4404	10...36 DC	-25...100	IP 65 / IP 67 / IP 68 / IP 69K	green / 2 x yellow	50	EVF007
	10 m grey MPPE cable	4 x 0.34 mm ² , Ø 4.9 mm	PP / stainless steel 316L / 1.4404	10...36 DC	-25...100	IP 65 / IP 67 / IP 68 / IP 69K	green / 2 x yellow	50	EVF008
	25 m grey MPPE cable	4 x 0.34 mm ² , Ø 4.9 mm	PP / stainless steel 316L / 1.4404	10...36 DC	-25...100	IP 65 / IP 67 / IP 68 / IP 69K	green / 2 x yellow	50	EVF009

Group 155 · Socket M12, 5-pole, 5-wire · halogen-free · Wiring diagram no. 11									
	5 m grey MPPE cable	5 x 0.34 mm ² , Ø 5.1 mm	PP / stainless steel 316L / 1.4404	60 AC 60 DC	-25...100	IP 65 / IP 67 / IP 68 / IP 69K	–	47	EVF010
	10 m grey MPPE cable	5 x 0.34 mm ² , Ø 5.1 mm	PP / stainless steel 316L / 1.4404	60 AC 60 DC	-25...100	IP 65 / IP 67 / IP 68 / IP 69K	–	47	EVF011
	25 m grey MPPE cable	5 x 0.34 mm ² , Ø 5.1 mm	PP / stainless steel 316L / 1.4404	60 AC 60 DC	-25...100	IP 65 / IP 67 / IP 68 / IP 69K	–	47	EVF012
	5 m grey MPPE cable	5 x 0.34 mm ² , Ø 5.1 mm	PP / stainless steel 316L / 1.4404	60 AC 60 DC	-25...100	IP 65 / IP 67 / IP 68 / IP 69K	–	46	EVF013
	10 m grey MPPE cable	5 x 0.34 mm ² , Ø 5.1 mm	PP / stainless steel 316L / 1.4404	60 AC 60 DC	-25...100	IP 65 / IP 67 / IP 68 / IP 69K	–	46	EVF014
	25 m grey MPPE cable	5 x 0.34 mm ² , Ø 5.1 mm	PP / stainless steel 316L / 1.4404	60 AC 60 DC	-25...100	IP 65 / IP 67 / IP 68 / IP 69K	–	46	EVF015

M12 cable sockets for hygienic and wet areas with screen

Type	Cable	Wire specification	Material housing / nut	U [V]	T _a [°C]	Protection	LEDs	Drawing no.	Order no.
Group 184 · Socket M12, screened, screen not connected to the socket, 5/4-pole, 4-wire · Wiring diagram no. 18									
	2 m orange PVC cable	4 x 0.34 mm ² , Ø 5.2 mm	PVC / stainless steel 316L / 1.4404	50 AC 60 DC	-25...100	IP 65 / IP 67 / IP 68 / IP 69K	–	47	EVT381
	5 m orange PVC cable	4 x 0.34 mm ² , Ø 5.2 mm	PVC / stainless steel 316L / 1.4404	50 AC 60 DC	-25...100	IP 65 / IP 67 / IP 68 / IP 69K	–	47	EVT382
	10 m orange PVC cable	4 x 0.34 mm ² , Ø 5.2 mm	PVC / stainless steel 316L / 1.4404	50 AC 60 DC	-25...100	IP 65 / IP 67 / IP 68 / IP 69K	–	47	EVT383

Type	Cable	Wire specification	Material housing / nut	U [V]	T _a [°C]	Protection	LEDs	Drawing no.	Order no.
Group 184 · Socket M12, screened, screen not connected to the socket, 5/4-pole, 4-wire · Wiring diagram no. 18									
	25 m orange PVC cable	4 x 0.34 mm ² , Ø 5.2 mm	PVC / stainless steel 316L / 1.4404	50 AC 60 DC	-25...100	IP 65 / IP 67 / IP 68 / IP 69K	-	47	EVT384
	2 m orange PVC cable	4 x 0.34 mm ² , Ø 5.2 mm	PVC / stainless steel 316L / 1.4404	50 AC 60 DC	-25...100	IP 65 / IP 67 / IP 68 / IP 69K	-	46	EVT385
	5 m orange PVC cable	4 x 0.34 mm ² , Ø 5.2 mm	PVC / stainless steel 316L / 1.4404	50 AC 60 DC	-25...100	IP 65 / IP 67 / IP 68 / IP 69K	-	46	EVT386
	10 m orange PVC cable	4 x 0.34 mm ² , Ø 5.2 mm	PVC / stainless steel 316L / 1.4404	50 AC 60 DC	-25...100	IP 65 / IP 67 / IP 68 / IP 69K	-	46	EVT387
	25 m orange PVC cable	4 x 0.34 mm ² , Ø 5.2 mm	PVC / stainless steel 316L / 1.4404	50 AC 60 DC	-25...100	IP 65 / IP 67 / IP 68 / IP 69K	-	46	EVT388
Group 186 · Socket M12, screened, screen not connected to the socket, 5-pole, 5-wire · Wiring diagram no. 19									
	2 m orange PVC cable	5 x 0.25 mm ² , Ø 5.2 mm	PVC / stainless steel 316L / 1.4404	30 AC 36 DC	-25...100	IP 65 / IP 67 / IP 68 / IP 69K	-	47	EVT389
	5 m orange PVC cable	5 x 0.25 mm ² , Ø 5.2 mm	PVC / stainless steel 316L / 1.4404	30 AC 36 DC	-25...100	IP 65 / IP 67 / IP 68 / IP 69K	-	47	EVT390
	10 m orange PVC cable	5 x 0.25 mm ² , Ø 5.2 mm	PVC / stainless steel 316L / 1.4404	30 AC 36 DC	-25...100	IP 65 / IP 67 / IP 68 / IP 69K	-	47	EVT391
	25 m orange PVC cable	5 x 0.25 mm ² , Ø 5.2 mm	PVC / stainless steel 316L / 1.4404	30 AC 36 DC	-25...100	IP 65 / IP 67 / IP 68 / IP 69K	-	47	EVT392
	2 m orange PVC cable	5 x 0.25 mm ² , Ø 5.2 mm	PVC / stainless steel 316L / 1.4404	30 AC 36 DC	-25...100	IP 65 / IP 67 / IP 68 / IP 69K	-	46	EVT393
	5 m orange PVC cable	5 x 0.25 mm ² , Ø 5.2 mm	PVC / stainless steel 316L / 1.4404	30 AC 36 DC	-25...100	IP 65 / IP 67 / IP 68 / IP 69K	-	46	EVT394
	10 m orange PVC cable	5 x 0.25 mm ² , Ø 5.2 mm	PVC / stainless steel 316L / 1.4404	30 AC 36 DC	-25...100	IP 65 / IP 67 / IP 68 / IP 69K	-	46	EVT395
	25 m orange PVC cable	5 x 0.25 mm ² , Ø 5.2 mm	PVC / stainless steel 316L / 1.4404	30 AC 36 DC	-25...100	IP 65 / IP 67 / IP 68 / IP 69K	-	46	EVT396
Group 188 · Socket M12, screened, screen connected to the socket, 5/4-pole, 4-wire · Wiring diagram no. 20									
	2 m orange PVC cable	4 x 0.34 mm ² , Ø 5.2 mm	PVC / stainless steel 316L / 1.4404	50 AC 60 DC	-25...100	IP 65 / IP 67 / IP 68 / IP 69K	-	47	EVT397

You can find wiring diagrams and scale drawings from page 780



Connection technology

Type	Cable	Wire specification	Material housing / nut	U [V]	T _a [°C]	Protection	LEDs	Drawing no.	Order no.
Group 188 · Socket M12, screened, screen connected to the socket, 5/4-pole, 4-wire · Wiring diagram no. 20									
	5 m orange PVC cable	4 x 0.34 mm ² , Ø 5.2 mm	PVC / stainless steel 316L / 1.4404	50 AC 60 DC	-25...100	IP 65 / IP 67 / IP 68 / IP 69K	–	47	EVT398
	10 m orange PVC cable	4 x 0.34 mm ² , Ø 5.2 mm	PVC / stainless steel 316L / 1.4404	50 AC 60 DC	-25...100	IP 65 / IP 67 / IP 68 / IP 69K	–	47	EVT399
	25 m orange PVC cable	4 x 0.34 mm ² , Ø 5.2 mm	PVC / stainless steel 316L / 1.4404	50 AC 60 DC	-25...100	IP 65 / IP 67 / IP 68 / IP 69K	–	47	EVT400
	2 m orange PVC cable	4 x 0.34 mm ² , Ø 5.2 mm	PVC / stainless steel 316L / 1.4404	50 AC 60 DC	-25...100	IP 65 / IP 67 / IP 68 / IP 69K	–	46	EVT401
	5 m orange PVC cable	4 x 0.34 mm ² , Ø 5.2 mm	PVC / stainless steel 316L / 1.4404	50 AC 60 DC	-25...100	IP 65 / IP 67 / IP 68 / IP 69K	–	46	EVT402
	10 m orange PVC cable	4 x 0.34 mm ² , Ø 5.2 mm	PVC / stainless steel 316L / 1.4404	50 AC 60 DC	-25...100	IP 65 / IP 67 / IP 68 / IP 69K	–	46	EVT403
	25 m orange PVC cable	4 x 0.34 mm ² , Ø 5.2 mm	PVC / stainless steel 316L / 1.4404	50 AC 60 DC	-25...100	IP 65 / IP 67 / IP 68 / IP 69K	–	46	EVT404
Group 190 · Socket M12, 5/4-pole, 4-wire, LED, PNP · Wiring diagram no. 29									
	2 m orange PVC cable	4 x 0.34 mm ² , Ø 4.9 mm	PVC / stainless steel 316L / 1.4404	10...36 DC	-25...100	IP 65 / IP 67 / IP 68 / IP 69K	2 x green / 4 x yellow	52	EVT461
	5 m orange PVC cable	4 x 0.34 mm ² , Ø 4.9 mm	PVC / stainless steel 316L / 1.4404	10...36 DC	-25...100	IP 65 / IP 67 / IP 68 / IP 69K	2 x green / 4 x yellow	52	EVT462
	10 m orange PVC cable	4 x 0.34 mm ² , Ø 4.9 mm	PVC / stainless steel 316L / 1.4404	10...36 DC	-25...100	IP 65 / IP 67 / IP 68 / IP 69K	2 x green / 4 x yellow	52	EVT463
	25 m orange PVC cable	4 x 0.34 mm ² , Ø 4.9 mm	PVC / stainless steel 316L / 1.4404	10...36 DC	-25...100	IP 65 / IP 67 / IP 68 / IP 69K	2 x green / 4 x yellow	52	EVT464
Group 192 · Socket M12, screened, screen connected to the socket, 5-pole, 5-wire · Wiring diagram no. 21									
	2 m orange PVC cable	5 x 0.25 mm ² , Ø 5.2 mm	PVC / stainless steel 316L / 1.4404	30 AC 36 DC	-25...100	IP 65 / IP 67 / IP 68 / IP 69K	–	47	EVT405
	5 m orange PVC cable	5 x 0.25 mm ² , Ø 5.2 mm	PVC / stainless steel 316L / 1.4404	30 AC 36 DC	-25...100	IP 65 / IP 67 / IP 68 / IP 69K	–	47	EVT406
	10 m orange PVC cable	5 x 0.25 mm ² , Ø 5.2 mm	PVC / stainless steel 316L / 1.4404	30 AC 36 DC	-25...100	IP 65 / IP 67 / IP 68 / IP 69K	–	47	EVT407

Product selectors and further information can be found at: www.ifm.com

Type	Cable	Wire specification	Material housing / nut	U [V]	T _a [°C]	Protection	LEDs	Drawing no.	Order no.
Group 192 · Socket M12, screened, screen connected to the socket, 5-pole, 5-wire · Wiring diagram no. 21									
	25 m orange PVC cable	5 x 0.25 mm ² , Ø 5.2 mm	PVC / stainless steel 316L / 1.4404	30 AC 36 DC	-25...100	IP 65 / IP 67 / IP 68 / IP 69K	–	47	EVT408
	2 m orange PVC cable	5 x 0.25 mm ² , Ø 5.2 mm	PVC / stainless steel 316L / 1.4404	30 AC 36 DC	-25...100	IP 65 / IP 67 / IP 68 / IP 69K	–	46	EVT409
	5 m orange PVC cable	5 x 0.25 mm ² , Ø 5.2 mm	PVC / stainless steel 316L / 1.4404	30 AC 36 DC	-25...100	IP 65 / IP 67 / IP 68 / IP 69K	–	46	EVT410
	10 m orange PVC cable	5 x 0.25 mm ² , Ø 5.2 mm	PVC / stainless steel 316L / 1.4404	30 AC 36 DC	-25...100	IP 65 / IP 67 / IP 68 / IP 69K	–	46	EVT411
	25 m orange PVC cable	5 x 0.25 mm ² , Ø 5.2 mm	PVC / stainless steel 316L / 1.4404	30 AC 36 DC	-25...100	IP 65 / IP 67 / IP 68 / IP 69K	–	46	EVT412
Group 193 · Socket M12, 5/4-pole, 4-wire · halogen-free · Wiring diagram no. 4									
	2 m grey MPPE cable	4 x 1.00 mm ² , Ø 6.2 mm	PP / stainless steel 316L / 1.4404	250 AC 300 DC	-25...100	IP 65 / IP 67 / IP 68 / IP 69K	–	47	EVF480
	5 m grey MPPE cable	4 x 1.00 mm ² , Ø 6.2 mm	PP / stainless steel 316L / 1.4404	250 AC 300 DC	-25...100	IP 65 / IP 67 / IP 68 / IP 69K	–	47	EVF481
	10 m grey MPPE cable	4 x 1.00 mm ² , Ø 6.2 mm	PP / stainless steel 316L / 1.4404	250 AC 300 DC	-25...100	IP 65 / IP 67 / IP 68 / IP 69K	–	47	EVF482
	20 m grey MPPE cable	4 x 1.00 mm ² , Ø 6.2 mm	PP / stainless steel 316L / 1.4404	250 AC 300 DC	-25...100	IP 65 / IP 67 / IP 68 / IP 69K	–	47	EVF483
	50 m grey MPPE cable	4 x 1.00 mm ² , Ø 6.2 mm	PP / stainless steel 316L / 1.4404	250 AC 300 DC	-25...100	IP 65 / IP 67 / IP 68 / IP 69K	–	47	EVF484
	2 m grey MPPE cable	4 x 1.00 mm ² , Ø 6.2 mm	PP / stainless steel 316L / 1.4404	250 AC 300 DC	-25...100	IP 65 / IP 67 / IP 68 / IP 69K	–	46	EVF485
	5 m grey MPPE cable	4 x 1.00 mm ² , Ø 6.2 mm	PP / stainless steel 316L / 1.4404	250 AC 300 DC	-25...100	IP 65 / IP 67 / IP 68 / IP 69K	–	46	EVF486
	10 m grey MPPE cable	4 x 1.00 mm ² , Ø 6.2 mm	PP / stainless steel 316L / 1.4404	250 AC 300 DC	-25...100	IP 65 / IP 67 / IP 68 / IP 69K	–	46	EVF487
	20 m grey MPPE cable	4 x 1.00 mm ² , Ø 6.2 mm	PP / stainless steel 316L / 1.4404	250 AC 300 DC	-25...100	IP 65 / IP 67 / IP 68 / IP 69K	–	46	EVF488





Connection technology

Type	Cable	Wire specification	Material housing / nut	U [V]	T _a [°C]	Protection	LEDs	Drawing no.	Order no.
------	-------	--------------------	------------------------	-------	---------------------	------------	------	-------------	-----------

Group 193 · Socket M12, 5/4-pole, 4-wire · halogen-free · Wiring diagram no. 4

	50 m grey MPPE cable	4 x 1.00 mm ² , Ø 6.2 mm	PP / stainless steel 316L / 1.4404	250 AC 300 DC	-25...100	IP 65 / IP 67 / IP 68 / IP 69K	-	46	EVF489
---	----------------------	-------------------------------------	------------------------------------	------------------	-----------	--------------------------------	---	----	---------------



Group 194 · Wirable socket M12, 5-pole · Wiring diagram no. 10

	wirable	...0.75 mm ² (Ø 4...6 mm)	PA / high-grade st. steel	60 AC/DC	-25...85	IP 67	-	53	E11865
	wirable	...0.75 mm ² (Ø 4...6 mm)	PA / high-grade st. steel	45 AC 70 DC	-25...90	IP 67	-	54	E11864

Connectors for hazardous areas

Type	Cable	Wire specification	Material housing / nut	U [V]	T _a [°C]	Protection	LEDs	Drawing no.	Order no.
------	-------	--------------------	------------------------	-------	---------------------	------------	------	-------------	-----------

Group 195 · Socket M12, 5/4 poles, 4 wires, cat. 1D / 1G · Wiring diagram no. 4

	2 m blue PUR cable	4 x 0.34 mm ² , Ø 4.9 mm	TPU / Brass	...30 DC	-25...90	IP 67	-	6	ENC04A
	5 m blue PUR cable	4 x 0.34 mm ² , Ø 4.9 mm	TPU / Brass	...30 DC	-25...90	IP 67	-	6	ENC05A
	10 m blue PUR cable	4 x 0.34 mm ² , Ø 4.9 mm	TPU / Brass	...30 DC	-25...90	IP 67	-	6	ENC06A
	2 m blue PUR cable	4 x 0.34 mm ² , Ø 4.9 mm	TPU / Brass	...30 DC	-25...90	IP 67	-	7	ENC01A
	5 m blue PUR cable	4 x 0.34 mm ² , Ø 4.9 mm	TPU / Brass	...30 DC	-25...90	IP 67	-	7	ENC02A
	10 m blue PUR cable	4 x 0.34 mm ² , Ø 4.9 mm	TPU / Brass	...30 DC	-25...90	IP 67	-	7	ENC03A

Group 196 · Socket M12, 5/4 poles, 4 wires, cat. 2D / 3G · Wiring diagram no. 4



	2 m black PUR cable	4 x 0.34 mm ² , Ø 4.9 mm	TPU / stainless steel 316L / 1.4404	60 AC 60 DC	-20...60	IP 67	-	55	EVC04A
	5 m black PUR cable	4 x 0.34 mm ² , Ø 4.9 mm	TPU / stainless steel 316L / 1.4404	60 AC 60 DC	-20...60	IP 67	-	55	EVC05A
	10 m black PUR cable	4 x 0.34 mm ² , Ø 4.9 mm	TPU / stainless steel 316L / 1.4404	60 AC 60 DC	-20...60	IP 67	-	55	EVC06A

Type	Cable	Wire specification	Material housing / nut	U [V]	T _a [°C]	Protection	LEDs	Drawing no.	Order no.
------	-------	--------------------	------------------------	-------	---------------------	------------	------	-------------	-----------

Group 196 · Socket M12, 5/4 poles, 4 wires, cat. 2D / 3G · Wiring diagram no. 4

	25 m black PUR cable	4 x 0.34 mm ² , Ø 4.9 mm	TPU / stainless steel 316L / 1.4404	60 AC 60 DC	-20...60	IP 67	–	55	EVC14A
---	----------------------	-------------------------------------	-------------------------------------	----------------	----------	-------	---	----	---------------



Group 197 · socket M12, 5 poles, 5 wires, cat. 1D / 1G · Wiring diagram no. 11

	2 m blue PUR cable	5 x 0.34 mm ² , Ø 4.9 mm	TPU / Brass	...30 DC	-25...90	IP 67	–	6	ENC10A
	5 m blue PUR cable	5 x 0.34 mm ² , Ø 4.9 mm	TPU / Brass	...30 DC	-25...90	IP 67	–	6	ENC11A
	10 m blue PUR cable	5 x 0.34 mm ² , Ø 4.9 mm	TPU / Brass	...30 DC	-25...90	IP 67	–	6	ENC12A
	25 m blue PUR cable	5 x 0.34 mm ² , Ø 4.9 mm	TPU / Brass	...30 DC	-25...90	IP 67	–	6	ENC13A
	50 m blue PUR cable	5 x 0.34 mm ² , Ø 4.9 mm	TPU / Brass	...30 DC	-25...90	IP 67	–	6	ENC14A
	2 m blue PUR cable	5 x 0.34 mm ² , Ø 4.9 mm	TPU / Brass	...30 DC	-25...90	IP 67	–	7	ENC07A
	5 m blue PUR cable	5 x 0.34 mm ² , Ø 4.9 mm	TPU / Brass	...30 DC	-25...90	IP 67	–	7	ENC08A
	10 m blue PUR cable	5 x 0.34 mm ² , Ø 4.9 mm	TPU / Brass	...30 DC	-25...90	IP 67	–	7	ENC09A

Connectors for robust applications

Type	Cable	Wire specification	Material housing / nut	U [V]	T _a [°C]	Protection	LEDs	Drawing no.	Order no.
------	-------	--------------------	------------------------	-------	---------------------	------------	------	-------------	-----------

Group 199 · Socket DEUTSCH Stecker DT, 6-pole, 2-wire · Wiring diagram no. 31

	1 m black PUR cable	2 x 0.50 mm ² , Ø 5.4 mm	PA	12...24 DC	-40...80	IP 67	–	56	E12549
	2 m black PUR cable	2 x 0.50 mm ² , Ø 5.4 mm	PA	12...24 DC	-40...80	IP 67	–	56	E12550
	5 m black PUR cable	2 x 0.50 mm ² , Ø 5.4 mm	PA	12...24 DC	-40...80	IP 67	–	56	E12551



Connection technology

Type	Cable	Wire specification	Material housing / nut	U [V]	T _a [°C]	Protection	LEDs	Drawing no.	Order no.
Group 200 · Socket DEUTSCH Stecker DT, 6-pole, 2-wire · Wiring diagram no. 32									
	1 m black PUR cable	3 x 0.50 mm ² , Ø 5.4 mm	PA	12...24 DC	-40...80	IP 67	–	56	E12543
	2 m black PUR cable	3 x 0.50 mm ² , Ø 5.4 mm	PA	12...24 DC	-40...80	IP 67	–	56	E12544
	5 m black PUR cable	3 x 0.50 mm ² , Ø 5.4 mm	PA	12...24 DC	-40...80	IP 67	–	56	E12545
Group 201 · Socket AMP, 6-wire · Wiring diagram no. 33									
	2 m black PVC cable	4 x 2.5 mm ² (Ø 2.8 mm) + 2 x 0.5 mm ² (Ø 1.5 mm)	PBT	12...24 DC	-40...100	–	–	57	E12565
	5 m black PVC cable	4 x 2.5 mm ² (Ø 2.8 mm) + 2 x 0.5 mm ² (Ø 1.5 mm)	PBT	12...24 DC	-40...100	–	–	57	E12566
Group 202 · Socket M12, 5/4-pole, 4-wire · Wiring diagram no. 4									
	2 m black PUR cable	4 x 0.34 mm ² , Ø 4.9 mm	TPU / stainless steel 316L / 1.4404	250 AC 300 DC	-40...90	IP 65 / IP 67 / IP 68 / IP 69K	–	55	EVM004
	5 m black PUR cable	4 x 0.34 mm ² , Ø 4.9 mm	TPU / stainless steel 316L / 1.4404	250 AC 300 DC	-40...90	IP 65 / IP 67 / IP 68 / IP 69K	–	55	EVM005
	10 m black PUR cable	4 x 0.34 mm ² , Ø 4.9 mm	TPU / stainless steel 316L / 1.4404	250 AC 300 DC	-40...90	IP 65 / IP 67 / IP 68 / IP 69K	–	55	EVM006
	25 m black PUR cable	4 x 0.34 mm ² , Ø 4.9 mm	TPU / stainless steel 316L / 1.4404	250 AC 300 DC	-40...90	IP 65 / IP 67 / IP 68 / IP 69K	–	55	EVM012
	50 m black PUR cable	4 x 0.34 mm ² , Ø 4.9 mm	TPU / stainless steel 316L / 1.4404	250 AC 300 DC	-40...90	IP 65 / IP 67 / IP 68 / IP 69K	–	55	EVM010
	2 m black PUR cable	4 x 0.34 mm ² , Ø 4.9 mm	TPU / stainless steel 316L / 1.4404	250 AC 300 DC	-40...90	IP 65 / IP 67 / IP 68 / IP 69K	–	58	EVM001
	5 m black PUR cable	4 x 0.34 mm ² , Ø 4.9 mm	TPU / stainless steel 316L / 1.4404	250 AC 300 DC	-40...90	IP 65 / IP 67 / IP 68 / IP 69K	–	58	EVM002
	10 m black PUR cable	4 x 0.34 mm ² , Ø 4.9 mm	TPU / stainless steel 316L / 1.4404	250 AC 300 DC	-40...90	IP 65 / IP 67 / IP 68 / IP 69K	–	58	EVM003
	25 m black PUR cable	4 x 0.34 mm ² , Ø 4.9 mm	TPU / stainless steel 316L / 1.4404	250 AC 300 DC	-40...90	IP 65 / IP 67 / IP 68 / IP 69K	–	58	EVM014

Product selectors and further information can be found at: www.ifm.com

Type	Cable	Wire specification	Material housing / nut	U [V]	T _a [°C]	Protection	LEDs	Drawing no.	Order no.
Group 203 · Socket M12, 5/4-pole, 4-wire, LED, PNP · Wiring diagram no. 9									
	2 m black PUR cable	4 x 0.34 mm ² , Ø 4.9 mm	TPU / stainless steel 316L / 1.4404	10...36 DC	-40...90	IP 65 / IP 67 / IP 68 / IP 69K	green / 2 x yellow	59	EVM007
	5 m black PUR cable	4 x 0.34 mm ² , Ø 4.9 mm	TPU / stainless steel 316L / 1.4404	10...36 DC	-40...90	IP 65 / IP 67 / IP 68 / IP 69K	green / 2 x yellow	59	EVM008
	10 m black PUR cable	4 x 0.34 mm ² , Ø 4.9 mm	TPU / stainless steel 316L / 1.4404	10...36 DC	-40...90	IP 65 / IP 67 / IP 68 / IP 69K	green / 2 x yellow	59	EVM009
Group 204 · Socket M12, 5/4-pole, 4-wire, LED, PNP · Wiring diagram no. 29									
	2 m black PUR cable	4 x 0.34 mm ² , Ø 4.9 mm	TPU / stainless steel 316L / 1.4404	10...36 DC	-40...90	IP 65 / IP 67 / IP 68 / IP 69K	2 x green / 4 x yellow	60	EVM068
	5 m black PUR cable	4 x 0.34 mm ² , Ø 4.9 mm	TPU / stainless steel 316L / 1.4404	10...36 DC	-40...90	IP 65 / IP 67 / IP 68 / IP 69K	2 x green / 4 x yellow	60	EVM069
	10 m black PUR cable	4 x 0.34 mm ² , Ø 4.9 mm	TPU / stainless steel 316L / 1.4404	10...36 DC	-40...90	IP 65 / IP 67 / IP 68 / IP 69K	2 x green / 4 x yellow	60	EVM070
Group 205 · Socket M12, 5-pole, 5-wire · Wiring diagram no. 11									
	2 m black PUR cable	5 x 0.34 mm ² , Ø 4.9 mm	TPU / stainless steel 316L / 1.4404	60 AC 60 DC	-40...90	IP 65 / IP 67 / IP 68 / IP 69K	–	58	EVM036
	5 m black PUR cable	5 x 0.34 mm ² , Ø 4.9 mm	TPU / stainless steel 316L / 1.4404	60 AC 60 DC	-40...90	IP 65 / IP 67 / IP 68 / IP 69K	–	58	EVM037
	10 m black PUR cable	5 x 0.34 mm ² , Ø 4.9 mm	TPU / stainless steel 316L / 1.4404	60 AC 60 DC	-40...90	IP 65 / IP 67 / IP 68 / IP 69K	–	58	EVM038
	2 m black PUR cable	5 x 0.34 mm ² , Ø 4.9 mm	TPU / stainless steel 316L / 1.4404	50 AC 60 DC	-40...90	IP 65 / IP 67 / IP 68 / IP 69K	–	55	EVM039
	5 m black PUR cable	5 x 0.34 mm ² , Ø 4.9 mm	TPU / stainless steel 316L / 1.4404	50 AC 60 DC	-40...90	IP 65 / IP 67 / IP 68 / IP 69K	–	55	EVM040
	10 m black PUR cable	5 x 0.34 mm ² , Ø 4.9 mm	TPU / stainless steel 316L / 1.4404	50 AC 60 DC	-40...90	IP 65 / IP 67 / IP 68 / IP 69K	–	55	EVM041



Connection technology

Wiring diagrams

Core colours

BK	black
BN	brown
BU	blue
WH	white
GN/YE	green/yellow
GY	grey
GN	green
YE	yellow
PK	pink
screen	Screen
OG	orange
VT	purple
RD	red
GY/PK	GY/PK
RD/BU	RD/BU
RD/BK	red/black
RD/WH	red/white

1

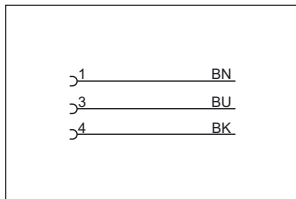

2

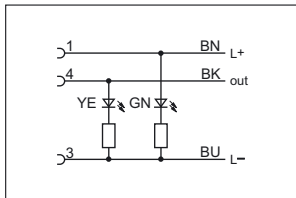

3

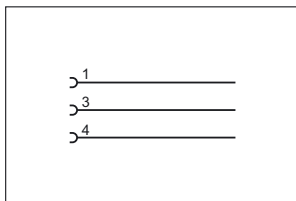

4

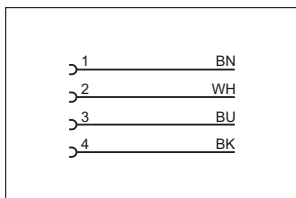

5

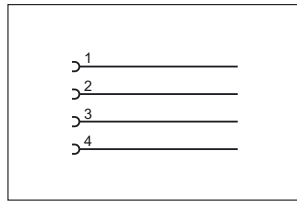

6

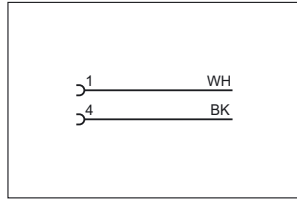

7

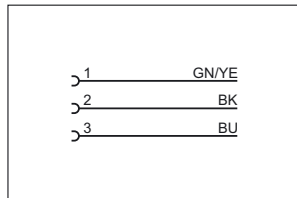

8

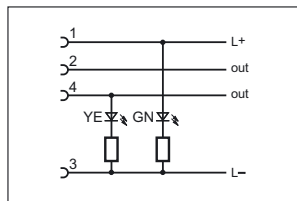

9

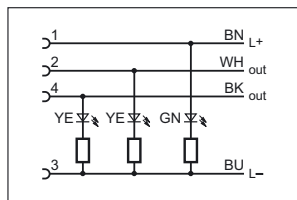

10

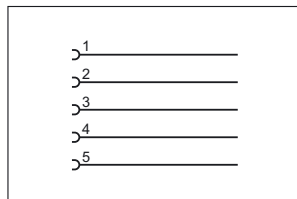

11

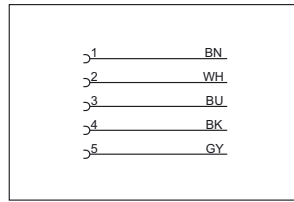

12

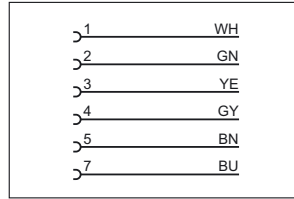

6: not used

13

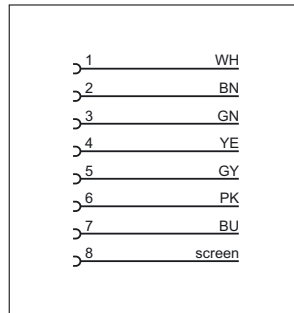

14

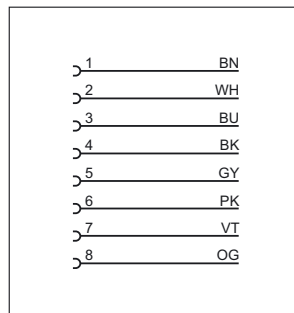

Colours to DIN EN 60947-5-2

15

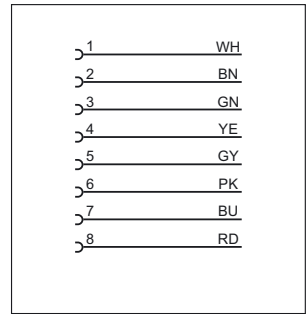

16

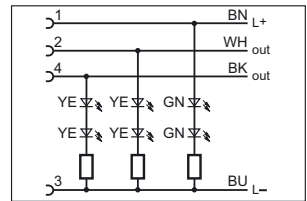

17

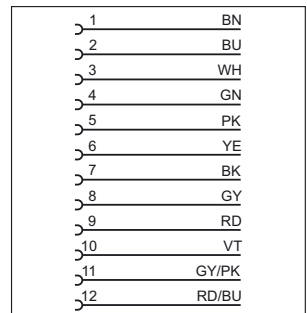

18

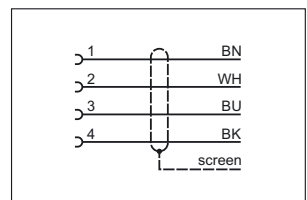

19

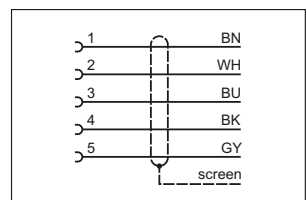

Wiring diagrams

20

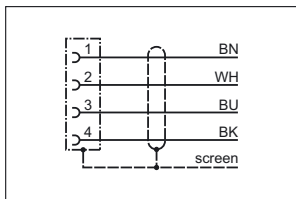

21

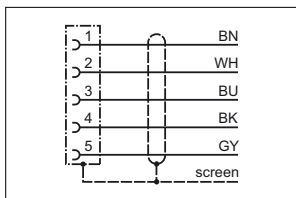

22

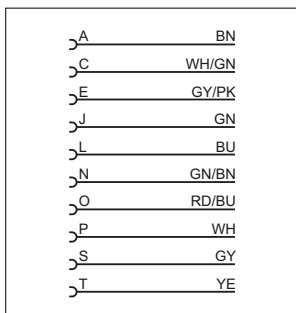

23

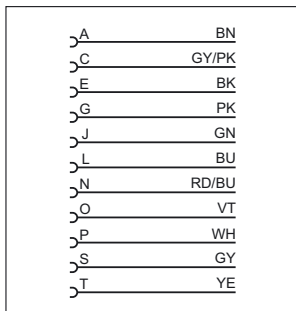

24

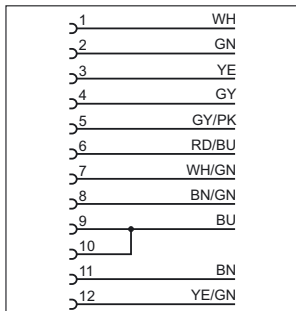

25

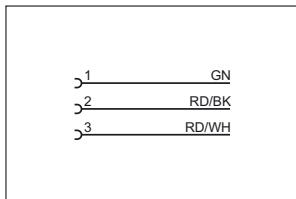

26

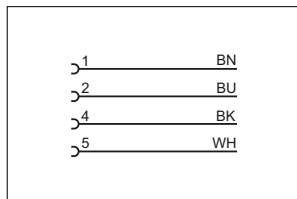

27

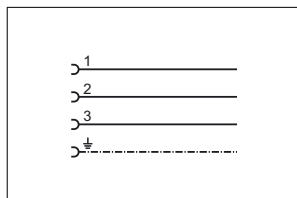

28

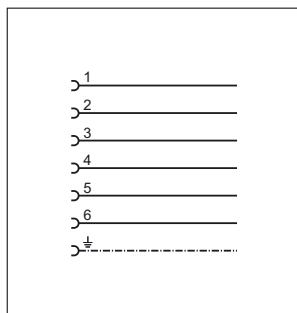

29

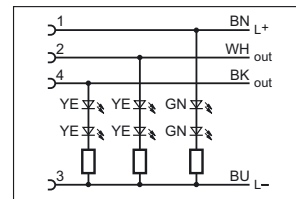

30

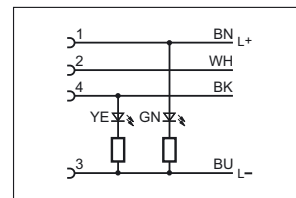

31

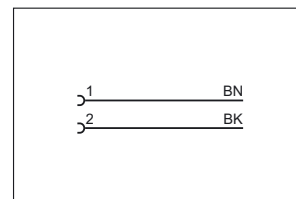

32

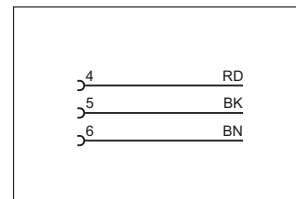

33

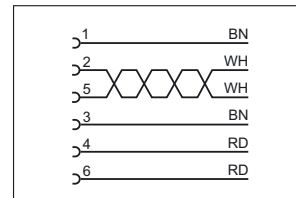

34

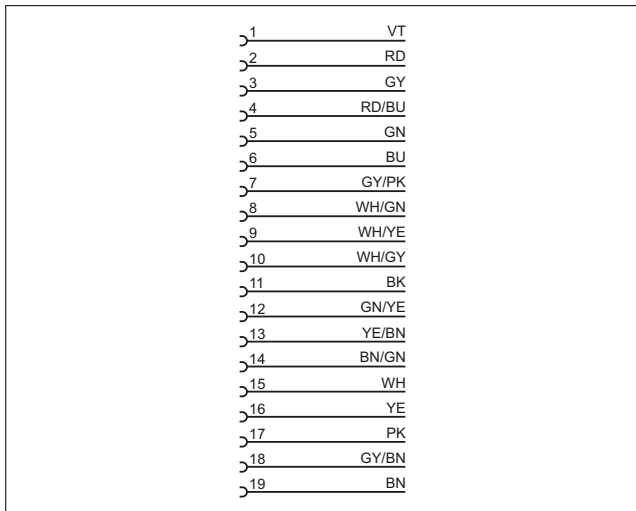



Scale drawings / drawing no. – CAD download: www.ifm.com

1

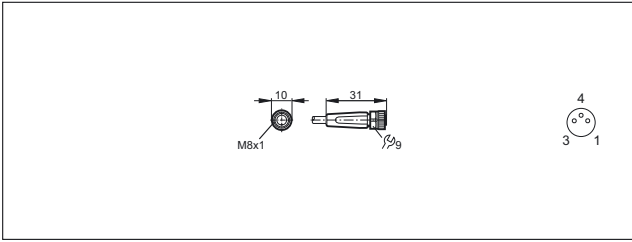

7

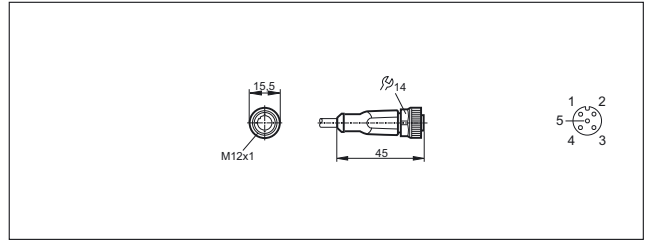

2

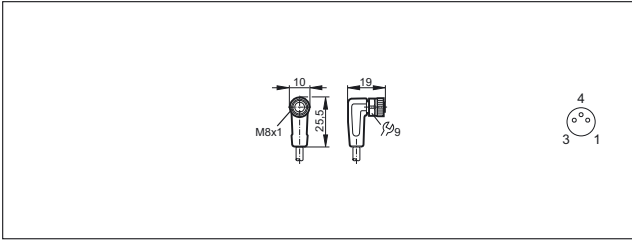

8

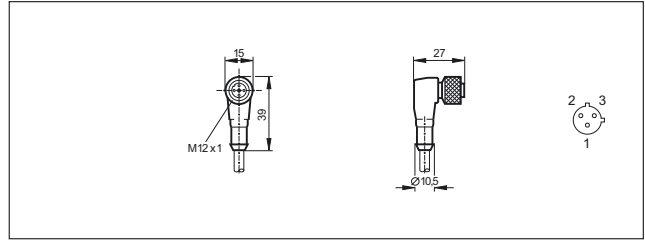

3

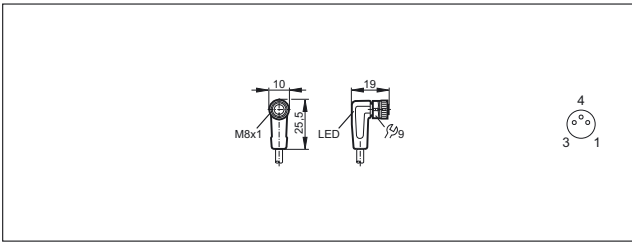

9

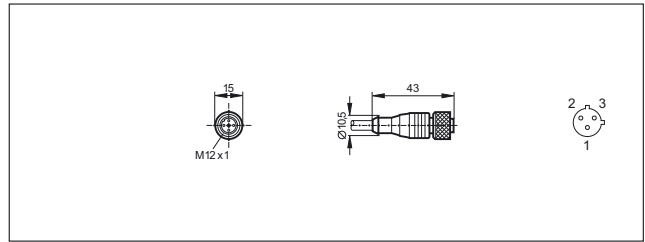

4

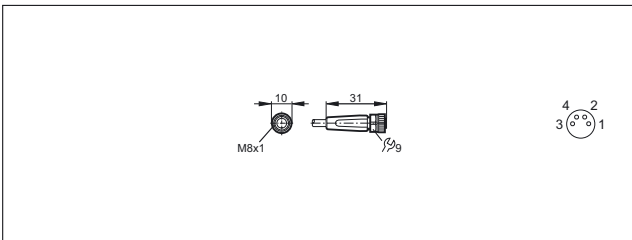

10

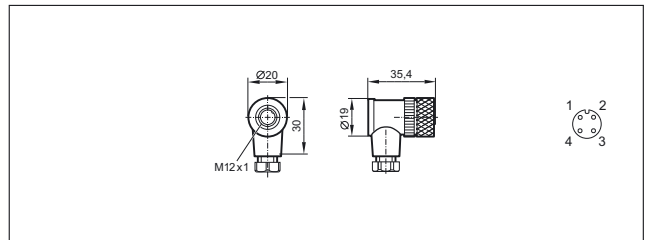

5

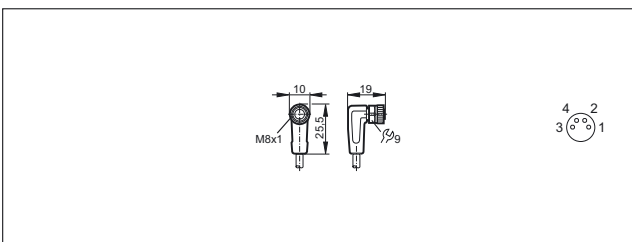

11

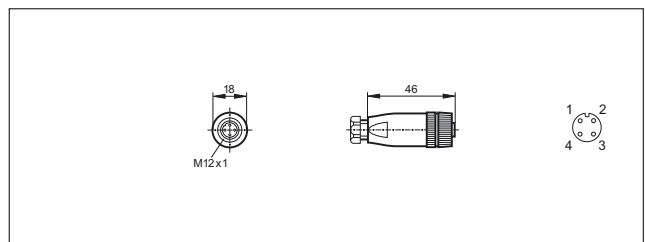

6

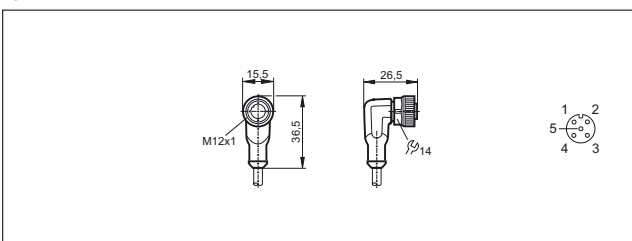

12

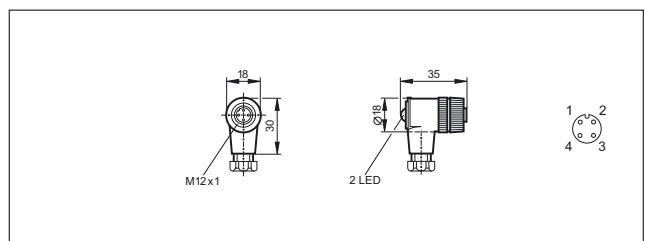

Scale drawings / drawing no. – CAD download: www.ifm.com

13

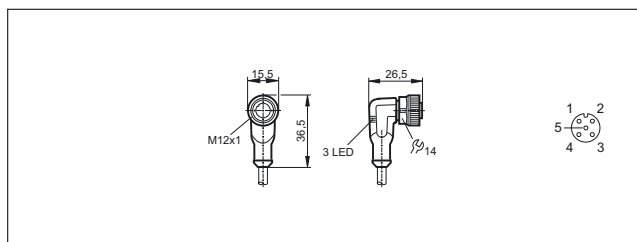

19

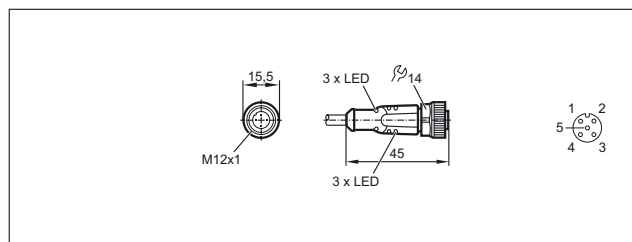

14

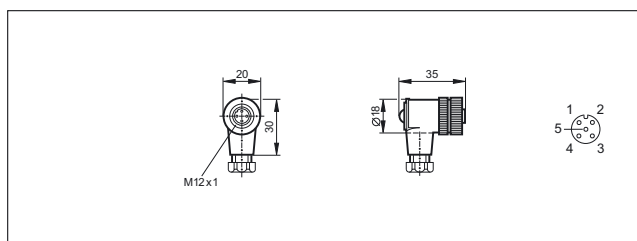

20

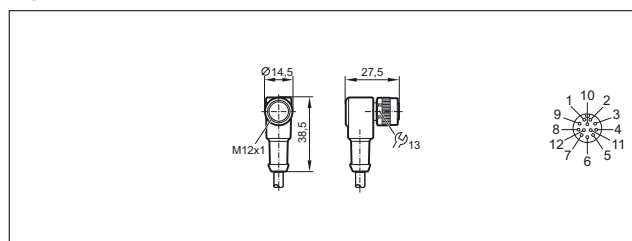

15

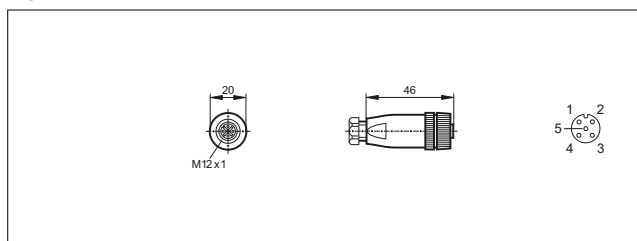

21

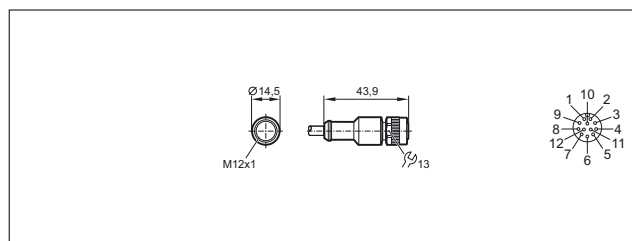

16

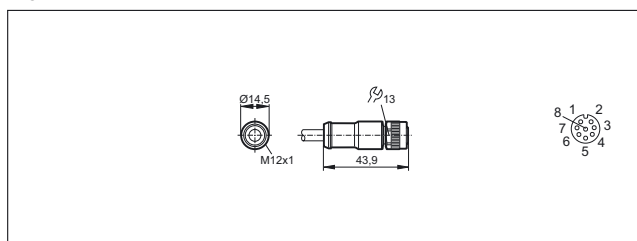

22

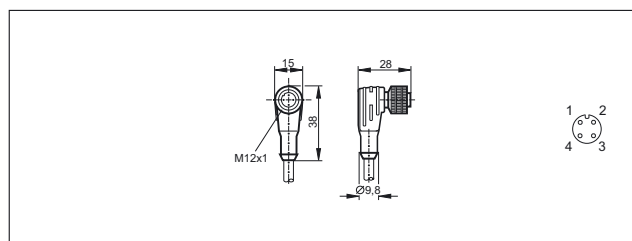

17

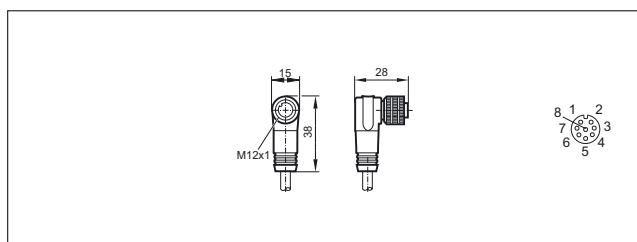

23

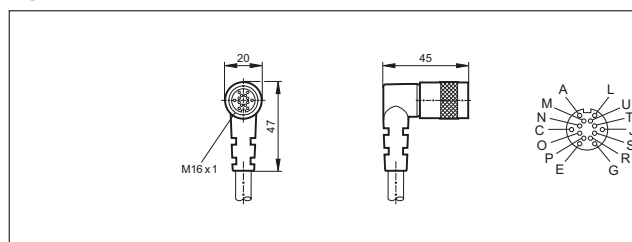

18

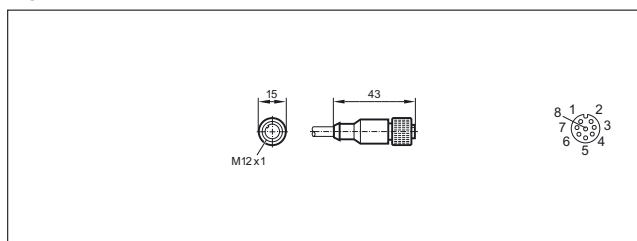

24

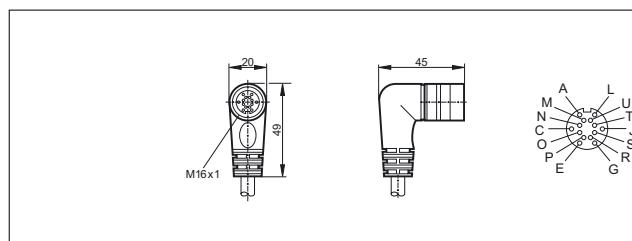



Scale drawings / drawing no. – CAD download: www.ifm.com

25

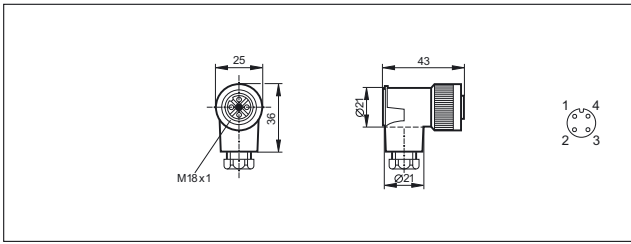

31

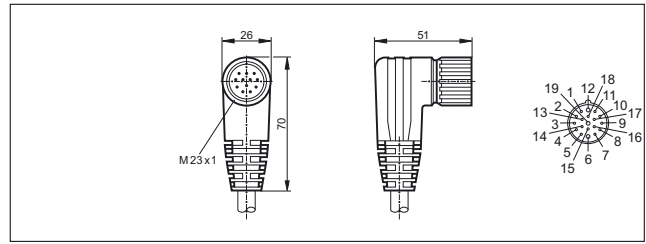

26

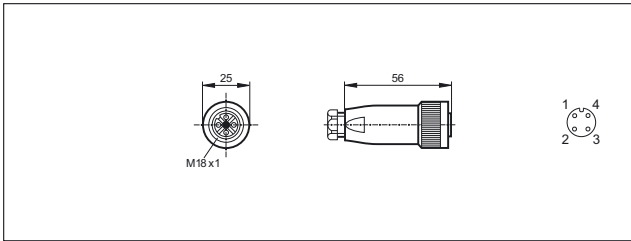

32

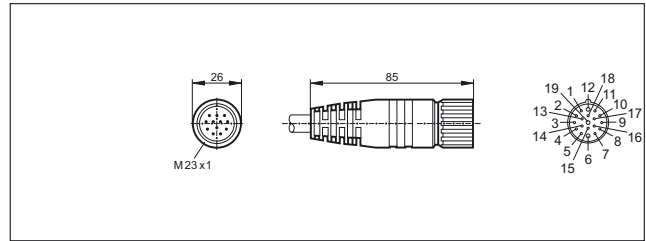

27

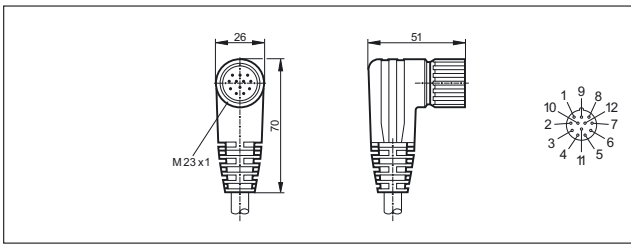

33

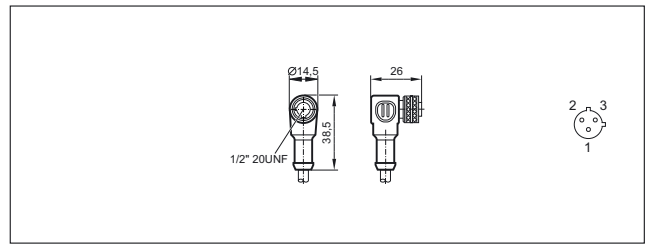

28

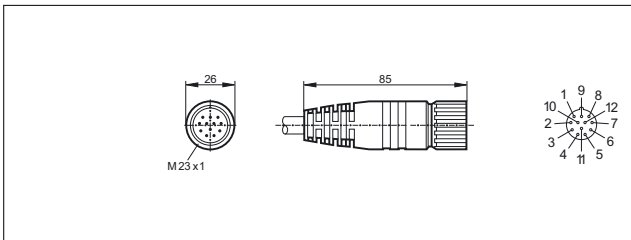

34

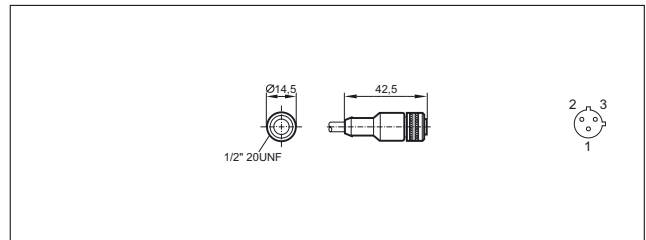

29

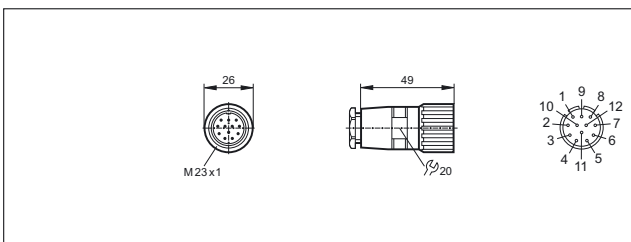

35

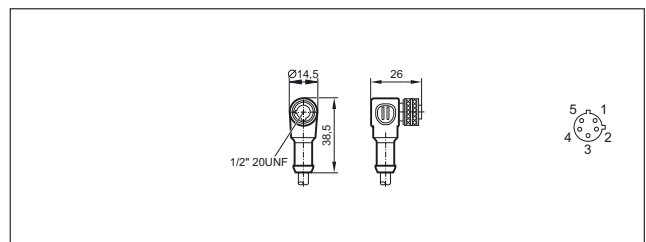

30

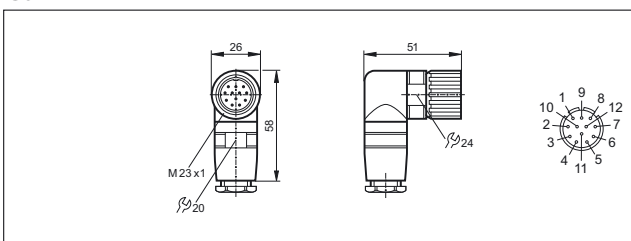

36

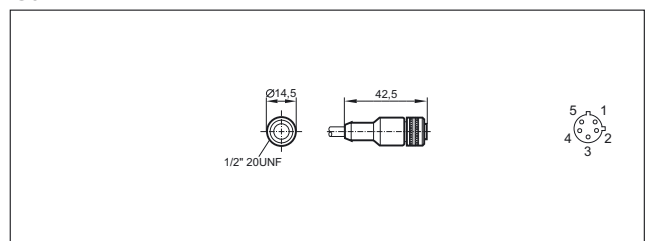

Scale drawings / drawing no. – CAD download: www.ifm.com

37

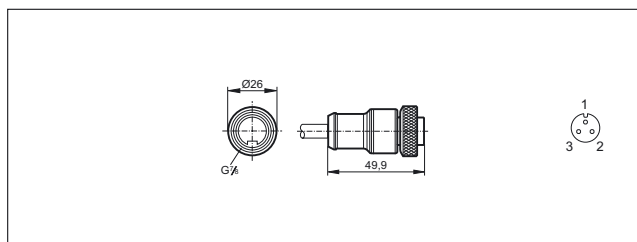

43

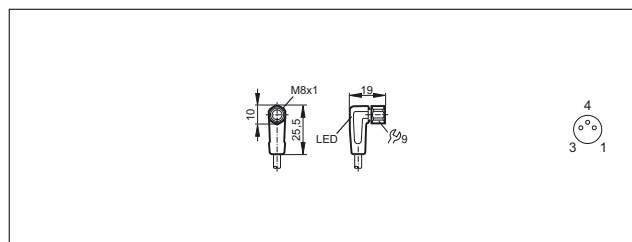

38

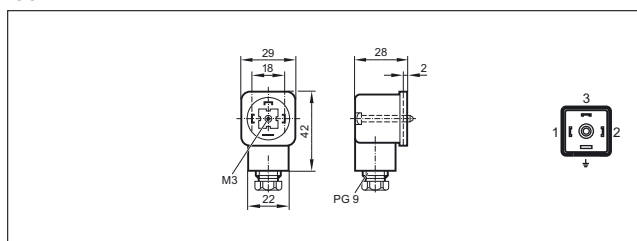

44

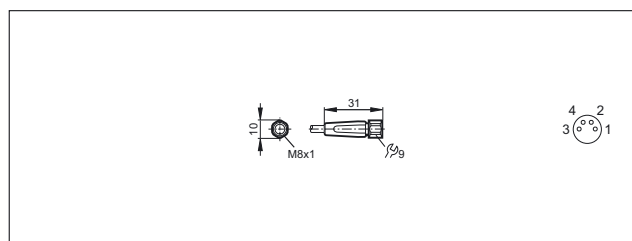

39

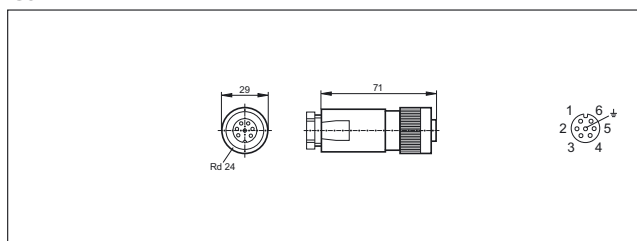

45

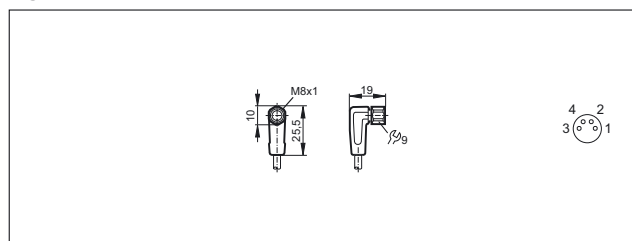

40

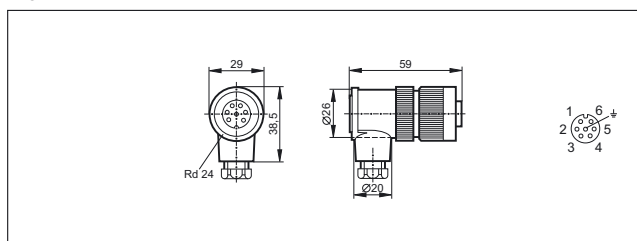

46

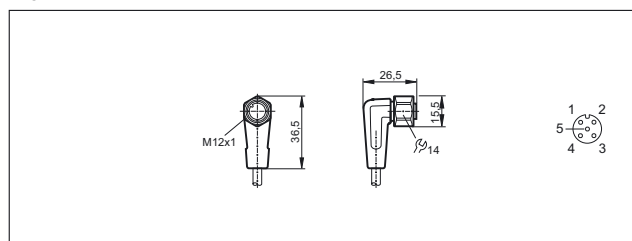

41

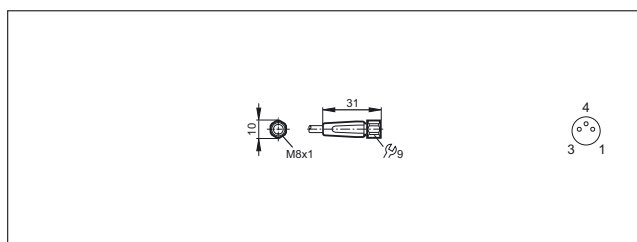

47

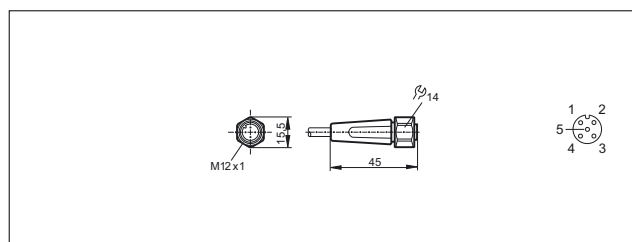

42

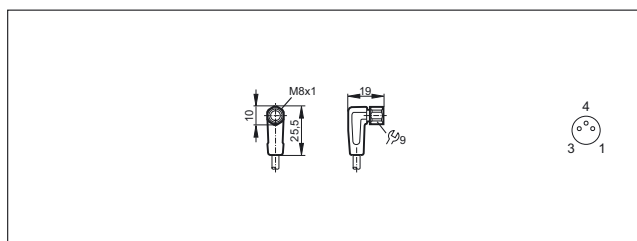

48

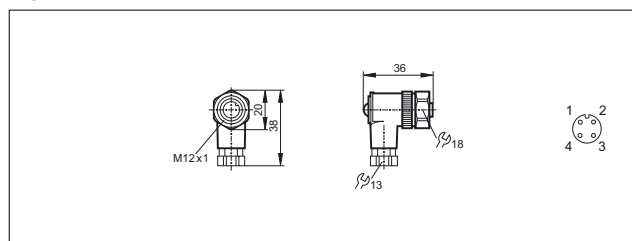



Connection technology

Scale drawings / drawing no. – CAD download: www.ifm.com

49

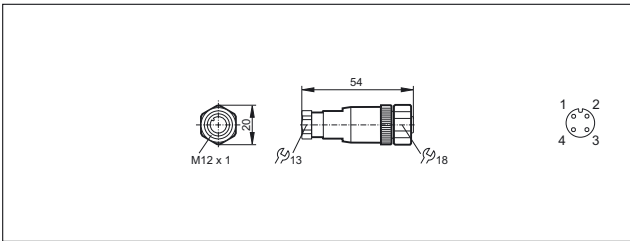

55

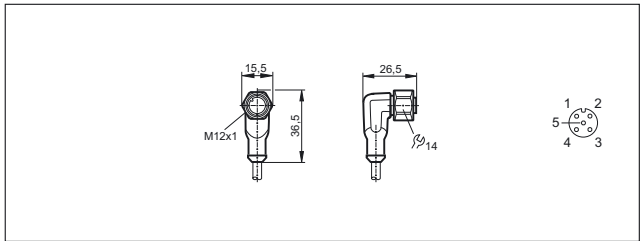

50

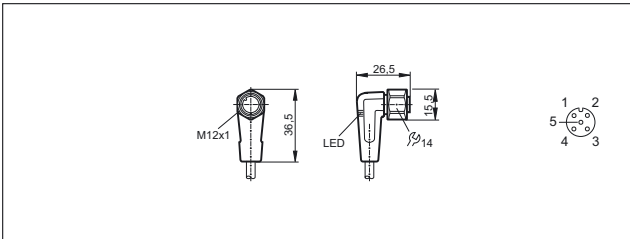

56

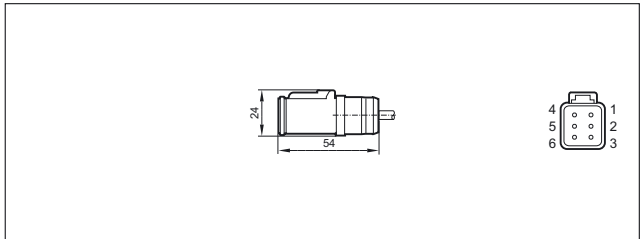

51

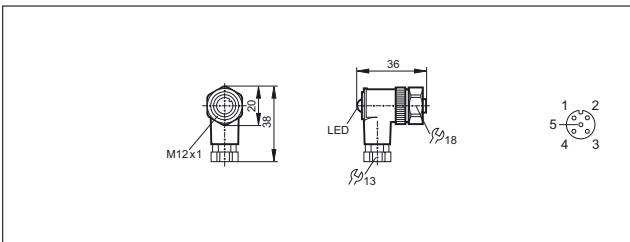

57

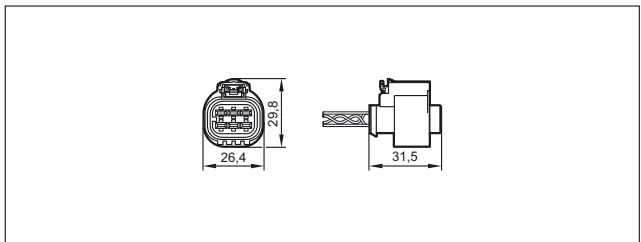

52

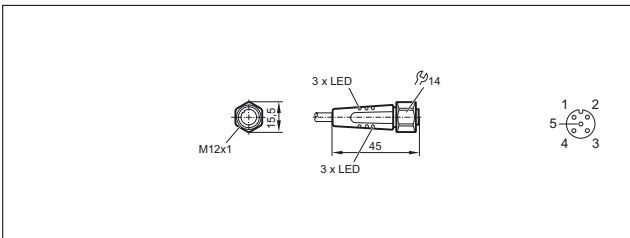

58

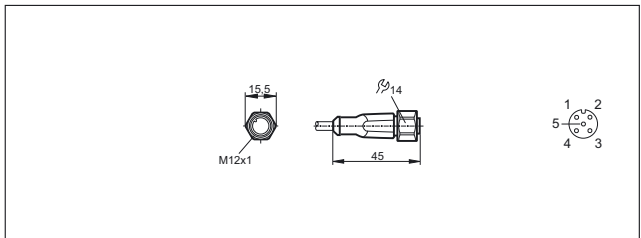

53

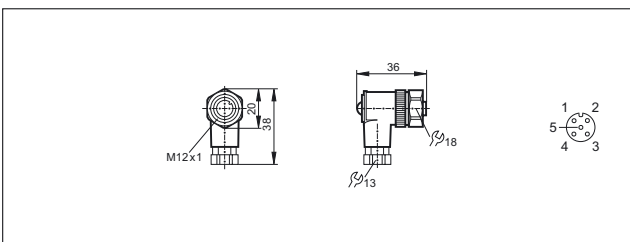

59

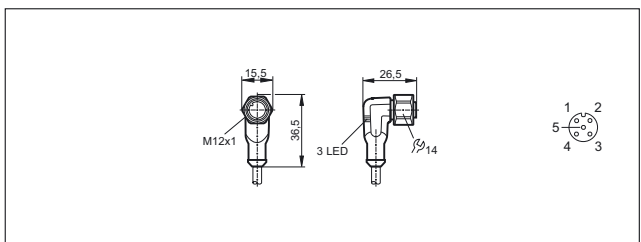

54

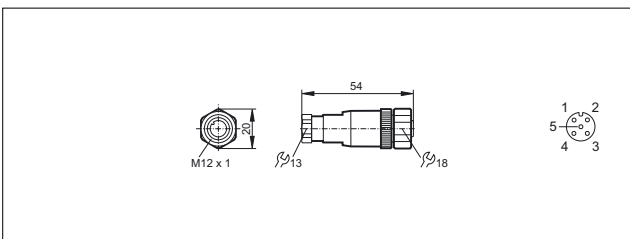

60

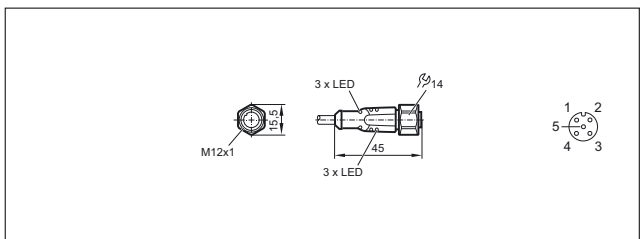





Connection technology





Plugs

Plugs are mainly used for the connection to splitter boxes and modules. High-quality pin contacts and materials ensure reliable electrical connections.

In addition to a wide range of standard products ifm also offers versions without silicone and halogen, versions for hygienic areas, for applications in contact with coolants and lubricants, as well as for welding applications.





System overview	Page
M8 cable plugs for industrial applications	788
M12 cable plugs for industrial applications	788 - 789
Connectors for hygienic and wet areas	789 - 790
Wiring diagrams	791
Scale drawings / drawing no. – CAD download: www.ifm.com	791 - 792

M8 cable plugs for industrial applications



Type	Cable	Wire specification	Material housing / nut	U [V]	T _a [°C]	Protection	LEDs	Drawing no.	Order no.
Group 39 · Wirable plug M8, 3-pole · Wiring diagram no. 1									
	wirable	–	PA / Brass	50 V AC 75 V DC	-25...90	IP 68	–	–	E11550
Group 40 · Wirable plug M8, 4-pole · Wiring diagram no. 2									
	wirable	–	PA / Brass	60 AC 75 DC	-25...90	IP 68	–	–	E11551

M12 cable plugs for industrial applications



Type	Cable	Wire specification	Material housing / nut	U [V]	T _a [°C]	Protection	LEDs	Drawing no.	Order no.
Group 41 · Cable plug M12, 4-pole, 4-wire · Wiring diagram no. 3									
	2 m black PUR cable	4 x 0.34 mm ² , Ø 4.9 mm	TPU / Brass	250 AC 300 DC	-25...90	IP 65 / IP 67 / IP 68 / IP 69K	–	1	EVC079
	5 m black PUR cable	4 x 0.34 mm ² , Ø 4.9 mm	TPU / Brass	250 AC 300 DC	-25...90	IP 65 / IP 67 / IP 68 / IP 69K	–	1	EVC080

Type	Cable	Wire specification	Material housing / nut	U [V]	T _a [°C]	Protection	LEDs	Drawing no.	Order no.
Group 41 · Cable plug M12, 4-pole, 4-wire · Wiring diagram no. 3									
	10 m black PUR cable	4 x 0.34 mm ² , Ø 4.9 mm	TPU / Brass	250 AC 300 DC	-25...90	IP 65 / IP 67 / IP 68 / IP 69K	–	1	EVC081
	2 m black PUR cable	4 x 0.34 mm ² , Ø 4.9 mm	TPU / Brass	250 AC 300 DC	-25...90	IP 65 / IP 67 / IP 68 / IP 69K	–	2	EVC076
	5 m black PUR cable	4 x 0.34 mm ² , Ø 4.9 mm	TPU / Brass	250 AC 300 DC	-25...90	IP 65 / IP 67 / IP 68 / IP 69K	–	2	EVC077
	10 m black PUR cable	4 x 0.34 mm ² , Ø 4.9 mm	TPU / Brass	250 AC 300 DC	-25...90	IP 65 / IP 67 / IP 68 / IP 69K	–	2	EVC078



Group 42 · Wirable plug M12, 4-pole · Wiring diagram no. 2

	wirable	...0.75 mm ² (Ø 4...6 mm)	PA / Brass	250 AC/DC	-25...85	IP 68	–	3	E11505
	wirable	...0.75 mm ² (Ø 4...6 mm)	PA / Brass	45 AC 70 DC	-25...85	IP 68	–	4	E11504

Group 43 · Cable plug M12, 5-pole, 5-wire · Wiring diagram no. 4

	2 m black PUR cable	5 x 0.34 mm ² , Ø 4.9 mm	TPU / Brass	60 AC 60 DC	-25...90	IP 65 / IP 67 / IP 68 / IP 69K	–	5	EVC095
	2 m black PUR cable	5 x 0.34 mm ² , Ø 4.9 mm	TPU / Brass	60 AC 60 DC	-25...90	IP 65 / IP 67 / IP 68 / IP 69K	–	6	EVC094

Group 44 · Wirable plug M12, 5-pole · Wiring diagram no. 5

	wirable	...0.75 mm ² (Ø 4...6 mm)	PA / Brass	125 AC/DC	-25...85	IP 68	–	7	E11507
	wirable	...0.75 mm ² (Ø 4...6 mm)	PA / Brass	45 AC 70 DC	-25...85	IP 68	–	8	E11506

Connectors for hygienic and wet areas

Type	Cable	Wire specification	Material housing / nut	U [V]	T _a [°C]	Protection	LEDs	Drawing no.	Order no.
Group 156 · Cable plug M12, 4-pole, 4-wire · Wiring diagram no. 3									
	2 m orange PVC cable	4 x 0.34 mm ² , Ø 4.9 mm	PVC / stainless steel 316L / 1.4404	250 AC 300 DC	-25...100	IP 65 / IP 67 / IP 68 / IP 69K	–	9	EVT071

You can find wiring diagrams and scale drawings from page 791



Connection technology

Type	Cable	Wire specification	Material housing / nut	U [V]	T _a [°C]	Protection	LEDs	Drawing no.	Order no.
Group 156 · Cable plug M12, 4-pole, 4-wire · Wiring diagram no. 3									
	5 m orange PVC cable	4 x 0.34 mm ² , Ø 4.9 mm	PVC / stainless steel 316L / 1.4404	250 AC 300 DC	-25...100	IP 65 / IP 67 / IP 68 / IP 69K	–	9	EVT072
	10 m orange PVC cable	4 x 0.34 mm ² , Ø 4.9 mm	PVC / stainless steel 316L / 1.4404	250 AC 300 DC	-25...100	IP 65 / IP 67 / IP 68 / IP 69K	–	9	EVT073
Group 157 · Cable plug M12, 4-pole, 4-wire · halogen-free · Wiring diagram no. 6									
	2 m grey MPPE cable	4 x 0.34 mm ² , Ø 6.5 mm	PP / stainless steel 316L / 1.4404	50 AC 60 DC	-25...80	IP 65 / IP 67 / IP 68 / IP 69K	–	10	EVF518
	5 m grey MPPE cable	4 x 0.34 mm ² , Ø 6.5 mm	PP / stainless steel 316L / 1.4404	50 AC 60 DC	-25...80	IP 65 / IP 67 / IP 68 / IP 69K	–	10	EVF519
	10 m grey MPPE cable	4 x 0.34 mm ² , Ø 6.5 mm	PP / stainless steel 316L / 1.4404	50 AC 60 DC	-25...80	IP 65 / IP 67 / IP 68 / IP 69K	–	10	EVF520
	20 m grey MPPE cable	4 x 0.34 mm ² , Ø 6.5 mm	PP / stainless steel 316L / 1.4404	50 AC 60 DC	-25...80	IP 65 / IP 67 / IP 68 / IP 69K	–	10	EVF521
	50 m grey MPPE cable	4 x 0.34 mm ² , Ø 6.5 mm	PP / stainless steel 316L / 1.4404	50 AC 60 DC	-25...80	IP 65 / IP 67 / IP 68 / IP 69K	–	10	EVF522
Group 158 · Wirable plug M12, 4-pole · Wiring diagram no. 2									
	wirable	...0.75 mm ² (Ø 4...6 mm)	PA / high-grade st. steel	45 AC 70 DC	-25...85	IP 67	–	11	E11858
	wirable	...0.75 mm ² (Ø 4...6 mm)	PA / high-grade st. steel	45 AC 70 DC	-25...85	IP 67	–	12	E11857
Group 159 · Cable plug M12, 5-pole, 5-wire · Wiring diagram no. 4									
	2 m orange PVC cable	5 x 0.34 mm ² , Ø 5.1 mm	PVC / stainless steel 316L / 1.4404	60 AC 60 DC	-25...100	IP 65 / IP 67 / IP 68 / IP 69K	–	13	EVT074
Group 160 · Wirable plug M12, 5-pole · Wiring diagram no. 5									
	wirable	...0.75 mm ² (Ø 4...6 mm)	PA / high-grade st. steel	60 AC/DC	-25...85	IP 67	–	14	E11860
	wirable	...0.75 mm ² (Ø 4...6 mm)	PA / high-grade st. steel	125 AC/DC	-25...85	IP 67	–	15	E11859

Wiring diagrams

Core colours

- BK black
- BN brown
- BU blue
- WH white
- GY grey
- OG orange
- YE yellow

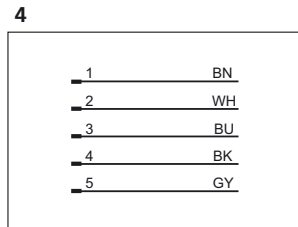
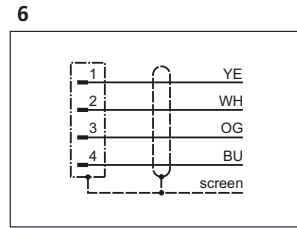
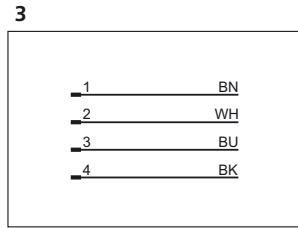
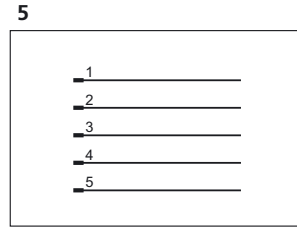
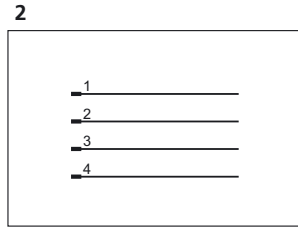
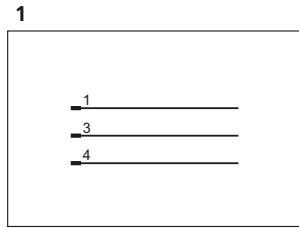

Scale drawings / drawing no. – CAD download: www.ifm.com

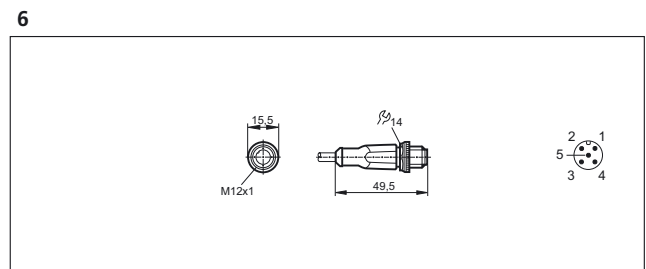
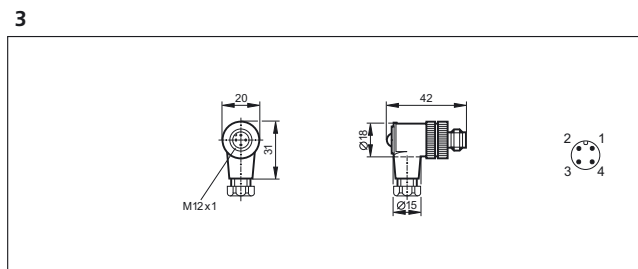
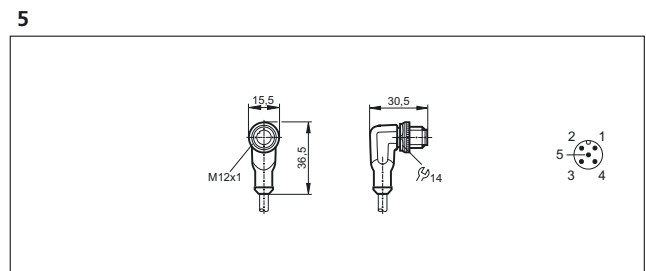
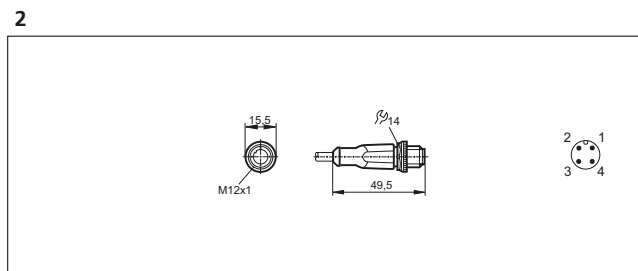
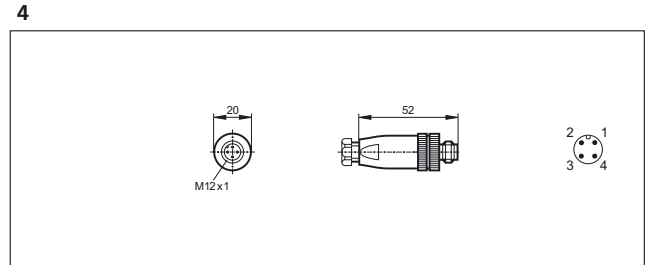
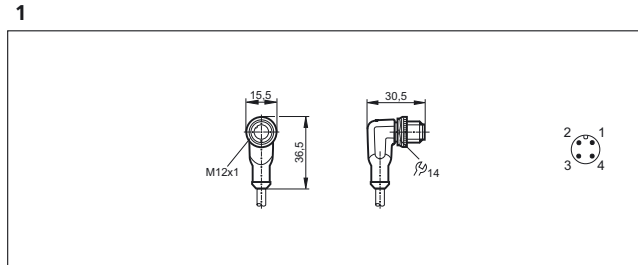



Connection technology

Scale drawings / drawing no. – CAD download: www.ifm.com

7

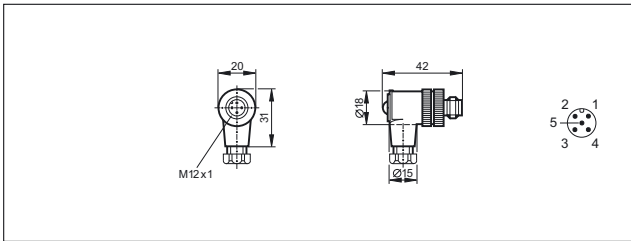

12

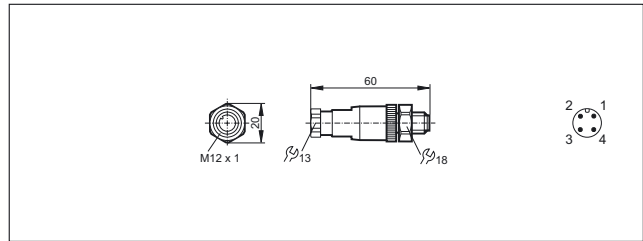

8

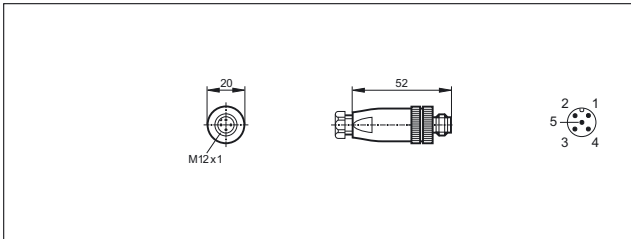

13

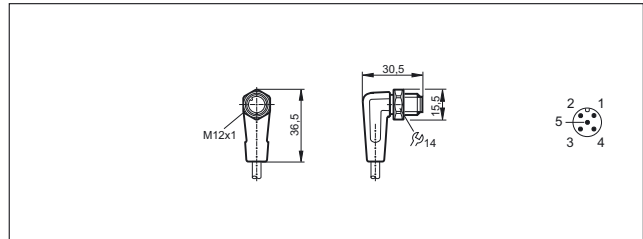

9

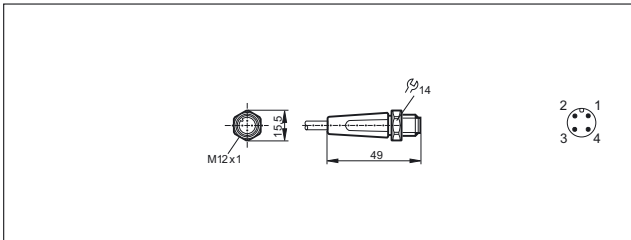

14

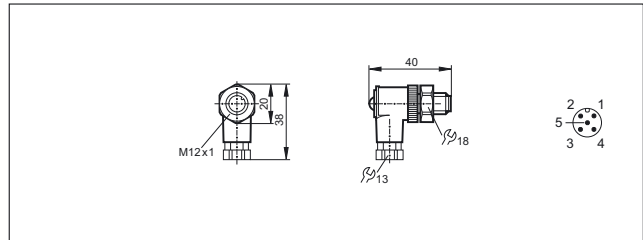

10

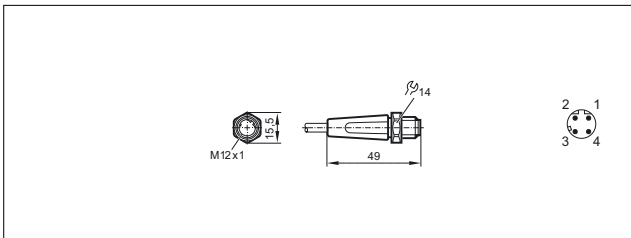

15

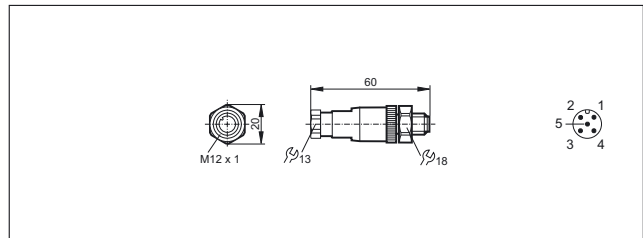

11

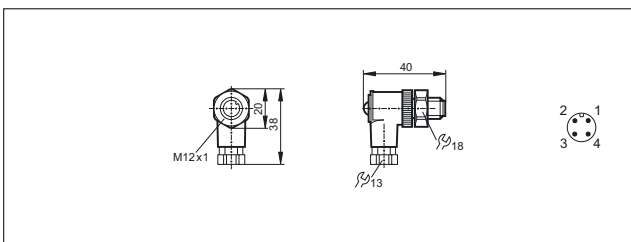





Connection technology



Jumper cables

Connection cables feature a plug and a socket. They are used for the connection of sensors to splitter boxes and modules.

High-quality contacts and materials ensure reliable electrical connections.

In addition to a wide range of standard products ifm also offers versions without silicone and halogen, versions for hygienic areas, for applications in contact with coolants and lubricants, as well as for welding applications.

System overview	Page
M8 – M8 jumpers for industrial applications	794 - 797
M8 socket – M12 plug jumpers for industrial applications	798 - 800
M8 plug - M12 socket jumpers for industrial applications	800 - 802
M12 – M12 jumpers for industrial applications	802 - 809
Valve - plug jumpers for industrial applications	809 - 811
Jumpers weld slag resistant	811 - 813
Jumpers for hygienic and wet areas	813 - 820
Jumpers for hygienic and wet areas	820 - 827
Jumpers for hazardous areas	828
Wiring diagrams	828
Scale drawings / drawing no. – CAD download: www.ifm.com	829 - 835

M8 – M8 jumpers for industrial applications

Type	Cable	Wire specification	Material housing / nut	U [V]	T _a [°C]	Protection	LEDs	Drawing no.	Order no.
Group 45 · Jumper , plug: M8, 3-pole, socket: M8, 3-pole, 3-wire · Wiring diagram no. 1									
	0.3 m black PUR cable	3 x 0.25 mm ² , Ø 3.7 mm	TPU / Brass	50 AC 60 DC	-25...90	IP 65 / IP 67 / IP 68 / IP 69K	-	1	EVC275
	0.6 m black PUR cable	3 x 0.25 mm ² , Ø 3.7 mm	TPU / Brass	50 AC 60 DC	-25...90	IP 65 / IP 67 / IP 68 / IP 69K	-	1	EVC276
	1 m black PUR cable	3 x 0.25 mm ² , Ø 3.7 mm	TPU / Brass	50 AC 60 DC	-25...90	IP 65 / IP 67 / IP 68 / IP 69K	-	1	EVC277
	2 m black PUR cable	3 x 0.25 mm ² , Ø 3.7 mm	TPU / Brass	50 AC 60 DC	-25...90	IP 65 / IP 67 / IP 68 / IP 69K	-	1	EVC278

Type	Cable	Wire specification	Material housing / nut	U [V]	T _a [°C]	Protection	LEDs	Drawing no.	Order no.
Group 45 · Jumper , plug: M8, 3-pole, socket: M8, 3-pole, 3-wire · Wiring diagram no. 1									
	5 m black PUR cable	3 x 0.25 mm ² , Ø 3.7 mm	TPU / Brass	50 AC 60 DC	-25...90	IP 65 / IP 67 / IP 68 / IP 69K	-	1	EVC279
	0.3 m black PUR cable	3 x 0.25 mm ² , Ø 3.7 mm	TPU / Brass	50 AC 60 DC	-25...90	IP 65 / IP 67 / IP 68 / IP 69K	-	2	EVC265
	0.6 m black PUR cable	3 x 0.25 mm ² , Ø 3.7 mm	TPU / Brass	50 AC 60 DC	-25...90	IP 65 / IP 67 / IP 68 / IP 69K	-	2	EVC266
	1 m black PUR cable	3 x 0.25 mm ² , Ø 3.7 mm	TPU / Brass	50 AC 60 DC	-25...90	IP 65 / IP 67 / IP 68 / IP 69K	-	2	EVC267
	2 m black PUR cable	3 x 0.25 mm ² , Ø 3.7 mm	TPU / Brass	50 AC 60 DC	-25...90	IP 65 / IP 67 / IP 68 / IP 69K	-	2	EVC268
	5 m black PUR cable	3 x 0.25 mm ² , Ø 3.7 mm	TPU / Brass	50 AC 60 DC	-25...90	IP 65 / IP 67 / IP 68 / IP 69K	-	2	EVC269
Group 46 · Jumper , plug: M8, 3-pole, socket: M8, 3-pole, 3-wire, LED, PNP · Wiring diagram no. 2									
	0.3 m black PUR cable	3 x 0.25 mm ² , Ø 3.7 mm	TPU / Brass	10...36 DC	-25...90	IP 65 / IP 67 / IP 68 / IP 69K	green / yellow	1	EVC280
	0.6 m black PUR cable	3 x 0.25 mm ² , Ø 3.7 mm	TPU / Brass	10...36 DC	-25...90	IP 65 / IP 67 / IP 68 / IP 69K	green / yellow	1	EVC281
	1 m black PUR cable	3 x 0.25 mm ² , Ø 3.7 mm	TPU / Brass	10...36 DC	-25...90	IP 65 / IP 67 / IP 68 / IP 69K	green / yellow	1	EVC282
	2 m black PUR cable	3 x 0.25 mm ² , Ø 3.7 mm	TPU / Brass	10...36 DC	-25...90	IP 65 / IP 67 / IP 68 / IP 69K	green / yellow	1	EVC283
	5 m black PUR cable	3 x 0.25 mm ² , Ø 3.7 mm	TPU / Brass	10...36 DC	-25...90	IP 65 / IP 67 / IP 68 / IP 69K	green / yellow	1	EVC284
Group 47 · Jumper , plug: M8, 4-pole, socket: M8, 3-pole, 3-wire · Wiring diagram no. 1									
	0.3 m black PUR cable	3 x 0.25 mm ² , Ø 3.7 mm	TPU / Brass	50 AC 60 DC	-25...90	IP 65 / IP 67 / IP 68 / IP 69K	-	3	EVC305
	0.6 m black PUR cable	3 x 0.25 mm ² , Ø 3.7 mm	TPU / Brass	50 AC 60 DC	-25...90	IP 65 / IP 67 / IP 68 / IP 69K	-	3	EVC306
	1 m black PUR cable	3 x 0.25 mm ² , Ø 3.7 mm	TPU / Brass	50 AC 60 DC	-25...90	IP 65 / IP 67 / IP 68 / IP 69K	-	3	EVC307

You can find wiring diagrams and scale drawings from page 828



Connection technology

Type	Cable	Wire specification	Material housing / nut	U [V]	T _a [°C]	Protection	LEDs	Drawing no.	Order no.
Group 47 · Jumper , plug: M8, 4-pole, socket: M8, 3-pole, 3-wire · Wiring diagram no. 1									
	2 m black PUR cable	3 x 0.25 mm ² , Ø 3.7 mm	TPU / Brass	50 AC 60 DC	-25...90	IP 65 / IP 67 / IP 68 / IP 69K	–	3	EVC308
	5 m black PUR cable	3 x 0.25 mm ² , Ø 3.7 mm	TPU / Brass	50 AC 60 DC	-25...90	IP 65 / IP 67 / IP 68 / IP 69K	–	3	EVC309
	0.3 m black PUR cable	3 x 0.25 mm ² , Ø 3.7 mm	TPU / Brass	50 AC 60 DC	-25...90	IP 65 / IP 67 / IP 68 / IP 69K	–	4	EVC315
	0.6 m black PUR cable	3 x 0.25 mm ² , Ø 3.7 mm	TPU / Brass	50 AC 60 DC	-25...90	IP 65 / IP 67 / IP 68 / IP 69K	–	4	EVC316
	1 m black PUR cable	3 x 0.25 mm ² , Ø 3.7 mm	TPU / Brass	50 AC 60 DC	-25...90	IP 65 / IP 67 / IP 68 / IP 69K	–	4	EVC317
	2 m black PUR cable	3 x 0.25 mm ² , Ø 3.7 mm	TPU / Brass	50 AC 60 DC	-25...90	IP 65 / IP 67 / IP 68 / IP 69K	–	4	EVC318
	5 m black PUR cable	3 x 0.25 mm ² , Ø 3.7 mm	TPU / Brass	50 AC 60 DC	-25...90	IP 65 / IP 67 / IP 68 / IP 69K	–	4	EVC319
Group 48 · Jumper , plug: M8, 3-pole, socket: M8, 4-pole, 3-wire · Wiring diagram no. 1									
	0.3 m black PUR cable	3 x 0.25 mm ² , Ø 3.7 mm	TPU / Brass	50 AC 60 DC	-25...90	IP 65 / IP 67 / IP 68 / IP 69K	–	5	EVC260
	0.6 m black PUR cable	3 x 0.25 mm ² , Ø 3.7 mm	TPU / Brass	50 AC 60 DC	-25...90	IP 65 / IP 67 / IP 68 / IP 69K	–	5	EVC261
	1 m black PUR cable	3 x 0.25 mm ² , Ø 3.7 mm	TPU / Brass	50 AC 60 DC	-25...90	IP 65 / IP 67 / IP 68 / IP 69K	–	5	EVC262
	2 m black PUR cable	3 x 0.25 mm ² , Ø 3.7 mm	TPU / Brass	50 AC 60 DC	-25...90	IP 65 / IP 67 / IP 68 / IP 69K	–	5	EVC263
	5 m black PUR cable	3 x 0.25 mm ² , Ø 3.7 mm	TPU / Brass	50 AC 60 DC	-25...90	IP 65 / IP 67 / IP 68 / IP 69K	–	5	EVC264
	0.3 m black PUR cable	3 x 0.25 mm ² , Ø 3.7 mm	TPU / Brass	50 AC 60 DC	-25...90	IP 65 / IP 67 / IP 68 / IP 69K	–	6	EVC270
	0.6 m black PUR cable	3 x 0.25 mm ² , Ø 3.7 mm	TPU / Brass	50 AC 60 DC	-25...90	IP 65 / IP 67 / IP 68 / IP 69K	–	6	EVC271
	1 m black PUR cable	3 x 0.25 mm ² , Ø 3.7 mm	TPU / Brass	50 AC 60 DC	-25...90	IP 65 / IP 67 / IP 68 / IP 69K	–	6	EVC272

Type	Cable	Wire specification	Material housing / nut	U [V]	T _a [°C]	Protection	LEDs	Drawing no.	Order no.
Group 48 · Jumper , plug: M8, 3-pole, socket: M8, 4-pole, 3-wire · Wiring diagram no. 1									
	2 m black PUR cable	3 x 0.25 mm ² , Ø 3.7 mm	TPU / Brass	50 AC 60 DC	-25...90	IP 65 / IP 67 / IP 68 / IP 69K	–	6	EVC273
	5 m black PUR cable	3 x 0.25 mm ² , Ø 3.7 mm	TPU / Brass	50 AC 60 DC	-25...90	IP 65 / IP 67 / IP 68 / IP 69K	–	6	EVC274
Group 49 · Jumper , plug: M8, 4-pole, socket: M8, 4-pole, 4-wire · Wiring diagram no. 3									
	0.3 m black PUR cable	4 x 0.25 mm ² , Ø 3.7 mm	TPU / Brass	50 AC 60 DC	-25...90	IP 65 / IP 67 / IP 68 / IP 69K	–	7	EVC300
	0.6 m black PUR cable	4 x 0.25 mm ² , Ø 3.7 mm	TPU / Brass	50 AC 60 DC	-25...90	IP 65 / IP 67 / IP 68 / IP 69K	–	7	EVC301
	1 m black PUR cable	4 x 0.25 mm ² , Ø 3.7 mm	TPU / Brass	50 AC 60 DC	-25...90	IP 65 / IP 67 / IP 68 / IP 69K	–	7	EVC302
	2 m black PUR cable	4 x 0.25 mm ² , Ø 3.7 mm	TPU / Brass	50 AC 60 DC	-25...90	IP 65 / IP 67 / IP 68 / IP 69K	–	7	EVC303
	5 m black PUR cable	4 x 0.25 mm ² , Ø 3.7 mm	TPU / Brass	50 AC 60 DC	-25...90	IP 65 / IP 67 / IP 68 / IP 69K	–	7	EVC304
	0.3 m black PUR cable	4 x 0.25 mm ² , Ø 3.7 mm	TPU / Brass	50 AC 60 DC	-25...90	IP 65 / IP 67 / IP 68 / IP 69K	–	8	EVC310
	0.6 m black PUR cable	4 x 0.25 mm ² , Ø 3.7 mm	TPU / Brass	50 AC 60 DC	-25...90	IP 65 / IP 67 / IP 68 / IP 69K	–	8	EVC311
	1 m black PUR cable	4 x 0.25 mm ² , Ø 3.7 mm	TPU / Brass	50 AC 60 DC	-25...90	IP 65 / IP 67 / IP 68 / IP 69K	–	8	EVC312
	2 m black PUR cable	4 x 0.25 mm ² , Ø 3.7 mm	TPU / Brass	50 AC 60 DC	-25...90	IP 65 / IP 67 / IP 68 / IP 69K	–	8	EVC313
	5 m black PUR cable	4 x 0.25 mm ² , Ø 3.7 mm	TPU / Brass	50 AC 60 DC	-25...90	IP 65 / IP 67 / IP 68 / IP 69K	–	8	EVC314



Connection technology

M8 socket – M12 plug jumpers for industrial applications

Type	Cable	Wire specification	Material housing / nut	U [V]	T _a [°C]	Protection	LEDs	Drawing no.	Order no.
Group 50 · Jumper , plug: M12, 3-pole, socket: M8, 3-pole, 3-wire · Wiring diagram no. 1									
	0.3 m black PUR cable	3 x 0.34 mm ² , Ø 4.9 mm	TPU / Brass	50 AC 60 DC	-25...90	IP 65 / IP 67 / IP 68 / IP 69K	–	9	EVC230
	0.6 m black PUR cable	3 x 0.34 mm ² , Ø 4.9 mm	TPU / Brass	50 AC 60 DC	-25...90	IP 65 / IP 67 / IP 68 / IP 69K	–	9	EVC231
	1 m black PUR cable	3 x 0.34 mm ² , Ø 4.9 mm	TPU / Brass	50 AC 60 DC	-25...90	IP 65 / IP 67 / IP 68 / IP 69K	–	9	EVC232
	2 m black PUR cable	3 x 0.34 mm ² , Ø 4.9 mm	TPU / Brass	50 AC 60 DC	-25...90	IP 65 / IP 67 / IP 68 / IP 69K	–	9	EVC233
	5 m black PUR cable	3 x 0.34 mm ² , Ø 4.9 mm	TPU / Brass	50 AC 60 DC	-25...90	IP 65 / IP 67 / IP 68 / IP 69K	–	9	EVC234
	0.3 m black PUR cable	3 x 0.34 mm ² , Ø 4.9 mm	TPU / Brass	50 AC 60 DC	-25...90	IP 65 / IP 67 / IP 68 / IP 69K	–	10	EVC215
	0.6 m black PUR cable	3 x 0.34 mm ² , Ø 4.9 mm	TPU / Brass	50 AC 60 DC	-25...90	IP 65 / IP 67 / IP 68 / IP 69K	–	10	EVC216
	1 m black PUR cable	3 x 0.34 mm ² , Ø 4.9 mm	TPU / Brass	50 AC 60 DC	-25...90	IP 65 / IP 67 / IP 68 / IP 69K	–	10	EVC217
	2 m black PUR cable	3 x 0.34 mm ² , Ø 4.9 mm	TPU / Brass	50 AC 60 DC	-25...90	IP 65 / IP 67 / IP 68 / IP 69K	–	10	EVC218
	5 m black PUR cable	3 x 0.34 mm ² , Ø 4.9 mm	TPU / Brass	50 AC 60 DC	-25...90	IP 65 / IP 67 / IP 68 / IP 69K	–	10	EVC219
Group 51 · Jumper , plug: M12, 3-pole, socket: M8, 3-pole, 3-wire, LED, PNP · Wiring diagram no. 2									
	0.3 m black PUR cable	3 x 0.34 mm ² , Ø 4.9 mm	TPU / Brass	10...36 DC	-25...90	IP 65 / IP 67 / IP 68 / IP 69K	green / yellow	11	EVC225
	0.6 m black PUR cable	3 x 0.34 mm ² , Ø 4.9 mm	TPU / Brass	10...36 DC	-25...90	IP 65 / IP 67 / IP 68 / IP 69K	green / yellow	11	EVC226
	1 m black PUR cable	3 x 0.34 mm ² , Ø 4.9 mm	TPU / Brass	10...36 DC	-25...90	IP 65 / IP 67 / IP 68 / IP 69K	green / yellow	11	EVC227
	2 m black PUR cable	3 x 0.34 mm ² , Ø 4.9 mm	TPU / Brass	10...36 DC	-25...90	IP 65 / IP 67 / IP 68 / IP 69K	green / yellow	11	EVC228

Type	Cable	Wire specification	Material housing / nut	U [V]	T _a [°C]	Protection	LEDs	Drawing no.	Order no.
------	-------	--------------------	------------------------	-------	---------------------	------------	------	-------------	-----------

Group 51 · Jumper , plug: M12, 3-pole, socket: M8, 3-pole, 3-wire, LED, PNP · Wiring diagram no. 2



5 m black PUR cable	3 x 0.34 mm ² , Ø 4.9 mm	TPU / Brass	10...36 DC	-25...90	IP 65 / IP 67 / IP 68 / IP 69K	green / yellow	11	EVC229
---------------------	-------------------------------------	-------------	------------	----------	--------------------------------	----------------	----	---------------

Group 52 · Jumper , plug: M12, 3-pole, socket: M8, 4-pole, 3-wire · Wiring diagram no. 1



0.3 m black PUR cable	3 x 0.34 mm ² , Ø 4.9 mm	TPU / Brass	50 AC 60 DC	-25...90	IP 65 / IP 67 / IP 68 / IP 69K	–	12	EVC210
0.6 m black PUR cable	3 x 0.34 mm ² , Ø 4.9 mm	TPU / Brass	50 AC 60 DC	-25...90	IP 65 / IP 67 / IP 68 / IP 69K	–	12	EVC211
1 m black PUR cable	3 x 0.34 mm ² , Ø 4.9 mm	TPU / Brass	50 AC 60 DC	-25...90	IP 65 / IP 67 / IP 68 / IP 69K	–	12	EVC212
2 m black PUR cable	3 x 0.34 mm ² , Ø 4.9 mm	TPU / Brass	50 AC 60 DC	-25...90	IP 65 / IP 67 / IP 68 / IP 69K	–	12	EVC213
5 m black PUR cable	3 x 0.34 mm ² , Ø 4.9 mm	TPU / Brass	50 AC 60 DC	-25...90	IP 65 / IP 67 / IP 68 / IP 69K	–	12	EVC214



0.3 m black PUR cable	3 x 0.34 mm ² , Ø 4.9 mm	TPU / Brass	50 AC 60 DC	-25...90	IP 65 / IP 67 / IP 68 / IP 69K	–	13	EVC220
0.6 m black PUR cable	3 x 0.34 mm ² , Ø 4.9 mm	TPU / Brass	50 AC 60 DC	-25...90	IP 65 / IP 67 / IP 68 / IP 69K	–	13	EVC221
1 m black PUR cable	3 x 0.34 mm ² , Ø 4.9 mm	TPU / Brass	50 AC 60 DC	-25...90	IP 65 / IP 67 / IP 68 / IP 69K	–	13	EVC222
2 m black PUR cable	3 x 0.34 mm ² , Ø 4.9 mm	TPU / Brass	50 AC 60 DC	-25...90	IP 65 / IP 67 / IP 68 / IP 69K	–	13	EVC223
5 m black PUR cable	3 x 0.34 mm ² , Ø 4.9 mm	TPU / Brass	50 AC 60 DC	-25...90	IP 65 / IP 67 / IP 68 / IP 69K	–	13	EVC224

Group 53 · Jumper , plug: M12, 4-pole, socket: M8, 4-pole, 4-wire · Wiring diagram no. 3



0.3 m black PUR cable	4 x 0.34 mm ² , Ø 4.9 mm	TPU / Brass	50 AC 60 DC	-25...90	IP 65 / IP 67 / IP 68 / IP 69K	–	14	EVC235
0.6 m black PUR cable	4 x 0.34 mm ² , Ø 4.9 mm	TPU / Brass	50 AC 60 DC	-25...90	IP 65 / IP 67 / IP 68 / IP 69K	–	14	EVC236
1 m black PUR cable	4 x 0.34 mm ² , Ø 4.9 mm	TPU / Brass	50 AC 60 DC	-25...90	IP 65 / IP 67 / IP 68 / IP 69K	–	14	EVC237



Connection technology

Type	Cable	Wire specification	Material housing / nut	U [V]	T _a [°C]	Protection	LEDs	Drawing no.	Order no.
Group 53 · Jumper , plug: M12, 4-pole, socket: M8, 4-pole, 4-wire · Wiring diagram no. 3									
	2 m black PUR cable	4 x 0.34 mm ² , Ø 4.9 mm	TPU / Brass	50 AC 60 DC	-25...90	IP 65 / IP 67 / IP 68 / IP 69K	–	14	EVC238
	5 m black PUR cable	4 x 0.34 mm ² , Ø 4.9 mm	TPU / Brass	50 AC 60 DC	-25...90	IP 65 / IP 67 / IP 68 / IP 69K	–	14	EVC239
	0.3 m black PUR cable	4 x 0.34 mm ² , Ø 4.9 mm	TPU / Brass	50 AC 60 DC	-25...90	IP 65 / IP 67 / IP 68 / IP 69K	–	15	EVC240
	0.6 m black PUR cable	4 x 0.34 mm ² , Ø 4.9 mm	TPU / Brass	50 AC 60 DC	-25...90	IP 65 / IP 67 / IP 68 / IP 69K	–	15	EVC241
	1 m black PUR cable	4 x 0.34 mm ² , Ø 4.9 mm	TPU / Brass	50 AC 60 DC	-25...90	IP 65 / IP 67 / IP 68 / IP 69K	–	15	EVC242
	2 m black PUR cable	4 x 0.34 mm ² , Ø 4.9 mm	TPU / Brass	50 AC 60 DC	-25...90	IP 65 / IP 67 / IP 68 / IP 69K	–	15	EVC243
	5 m black PUR cable	4 x 0.34 mm ² , Ø 4.9 mm	TPU / Brass	50 AC 60 DC	-25...90	IP 65 / IP 67 / IP 68 / IP 69K	–	15	EVC244

M8 plug - M12 socket jumpers for industrial applications

Type	Cable	Wire specification	Material housing / nut	U [V]	T _a [°C]	Protection	LEDs	Drawing no.	Order no.
Group 54 · Jumper , plug: M8, 3-pole, socket: M12, 5/4-pole, 3-wire · Wiring diagram no. 1									
	0.3 m black PUR cable	3 x 0.34 mm ² , Ø 4.9 mm	TPU / Brass	50 AC 60 DC	-25...90	IP 65 / IP 67 / IP 68 / IP 69K	–	16	EVC245
	0.6 m black PUR cable	3 x 0.34 mm ² , Ø 4.9 mm	TPU / Brass	50 AC 60 DC	-25...90	IP 65 / IP 67 / IP 68 / IP 69K	–	16	EVC246
	1 m black PUR cable	3 x 0.34 mm ² , Ø 4.9 mm	TPU / Brass	50 AC 60 DC	-25...90	IP 65 / IP 67 / IP 68 / IP 69K	–	16	EVC247
	2 m black PUR cable	3 x 0.34 mm ² , Ø 4.9 mm	TPU / Brass	50 AC 60 DC	-25...90	IP 65 / IP 67 / IP 68 / IP 69K	–	16	EVC248
	5 m black PUR cable	3 x 0.34 mm ² , Ø 4.9 mm	TPU / Brass	50 AC 60 DC	-25...90	IP 65 / IP 67 / IP 68 / IP 69K	–	16	EVC249

Type	Cable	Wire specification	Material housing / nut	U [V]	T _a [°C]	Protection	LEDs	Drawing no.	Order no.
------	-------	--------------------	------------------------	-------	---------------------	------------	------	-------------	-----------

Group 55 · Jumper , plug: M8, 3-pole, socket: M12, 5-pole, 3-wire · Wiring diagram no. 1

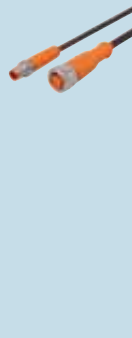
	0.3 m black PUR cable	3 x 0.34 mm ² , Ø 4.9 mm	TPU / Brass	50 AC 60 DC	-25...90	IP 65 / IP 67 / IP 68 / IP 69K	-	17	EVC255
	0.6 m black PUR cable	3 x 0.34 mm ² , Ø 4.9 mm	TPU / Brass	50 AC 60 DC	-25...90	IP 65 / IP 67 / IP 68 / IP 69K	-	17	EVC256
	1 m black PUR cable	3 x 0.34 mm ² , Ø 4.9 mm	TPU / Brass	50 AC 60 DC	-25...90	IP 65 / IP 67 / IP 68 / IP 69K	-	17	EVC257
	2 m black PUR cable	3 x 0.34 mm ² , Ø 4.9 mm	TPU / Brass	50 AC 60 DC	-25...90	IP 65 / IP 67 / IP 68 / IP 69K	-	17	EVC258
	5 m black PUR cable	3 x 0.34 mm ² , Ø 4.9 mm	TPU / Brass	50 AC 60 DC	-25...90	IP 65 / IP 67 / IP 68 / IP 69K	-	17	EVC259

Group 56 · Jumper , plug: M8, 3-pole, socket: M12, 5-pole, 3-wire, LED, PNP · Wiring diagram no. 2

	0.3 m black PUR cable	3 x 0.34 mm ² , Ø 4.9 mm	TPU / Brass	10...36 DC	-25...90	IP 65 / IP 67 / IP 68 / IP 69K	green / yellow	18	EVC250
	0.6 m black PUR cable	3 x 0.34 mm ² , Ø 4.9 mm	TPU / Brass	10...36 DC	-25...90	IP 65 / IP 67 / IP 68 / IP 69K	green / yellow	18	EVC251
	1 m black PUR cable	3 x 0.34 mm ² , Ø 4.9 mm	TPU / Brass	10...36 DC	-25...90	IP 65 / IP 67 / IP 68 / IP 69K	green / yellow	18	EVC252
	2 m black PUR cable	3 x 0.34 mm ² , Ø 4.9 mm	TPU / Brass	10...36 DC	-25...90	IP 65 / IP 67 / IP 68 / IP 69K	green / yellow	18	EVC253
	5 m black PUR cable	3 x 0.34 mm ² , Ø 4.9 mm	TPU / Brass	10...36 DC	-25...90	IP 65 / IP 67 / IP 68 / IP 69K	green / yellow	18	EVC254

Group 57 · Jumper , plug: M8, 4-pole, socket: M12, 5-pole, 4-wire · Wiring diagram no. 3

	0.3 m black PUR cable	4 x 0.34 mm ² , Ø 4.9 mm	TPU / Brass	50 AC 60 DC	-25...90	IP 65 / IP 67 / IP 68 / IP 69K	-	19	EVC285
	0.6 m black PUR cable	4 x 0.34 mm ² , Ø 4.9 mm	TPU / Brass	50 AC 60 DC	-25...90	IP 65 / IP 67 / IP 68 / IP 69K	-	19	EVC286
	1 m black PUR cable	4 x 0.34 mm ² , Ø 4.9 mm	TPU / Brass	50 AC 60 DC	-25...90	IP 65 / IP 67 / IP 68 / IP 69K	-	19	EVC287
	2 m black PUR cable	4 x 0.34 mm ² , Ø 4.9 mm	TPU / Brass	50 AC 60 DC	-25...90	IP 65 / IP 67 / IP 68 / IP 69K	-	19	EVC288



Connection technology

Type	Cable	Wire specification	Material housing / nut	U [V]	T _a [°C]	Protection	LEDs	Drawing no.	Order no.
------	-------	--------------------	------------------------	-------	---------------------	------------	------	-------------	-----------

Group 57 · Jumper , plug: M8, 4-pole, socket: M12, 5-pole, 4-wire · Wiring diagram no. 3

	5 m black PUR cable	4 x 0.34 mm ² , Ø 4.9 mm	TPU / Brass	50 AC 60 DC	-25...90	IP 65 / IP 67 / IP 68 / IP 69K	–	19	EVC289
---	---------------------	-------------------------------------	-------------	----------------	----------	-----------------------------------	---	----	---------------

Group 58 · Jumper , plug: M8, 4-pole, socket: M12, 5/4-pole, 4-wire · Wiring diagram no. 3

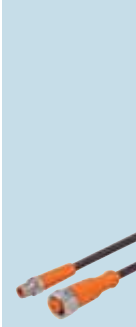
	0.3 m black PUR cable	4 x 0.34 mm ² , Ø 4.9 mm	TPU / Brass	50 AC 60 DC	-25...90	IP 65 / IP 67 / IP 68 / IP 69K	–	20	EVC295
	0.6 m black PUR cable	4 x 0.34 mm ² , Ø 4.9 mm	TPU / Brass	50 AC 60 DC	-25...90	IP 65 / IP 67 / IP 68 / IP 69K	–	20	EVC296
	1 m black PUR cable	4 x 0.34 mm ² , Ø 4.9 mm	TPU / Brass	50 AC 60 DC	-25...90	IP 65 / IP 67 / IP 68 / IP 69K	–	20	EVC297
	2 m black PUR cable	4 x 0.34 mm ² , Ø 4.9 mm	TPU / Brass	50 AC 60 DC	-25...90	IP 65 / IP 67 / IP 68 / IP 69K	–	20	EVC298
	5 m black PUR cable	4 x 0.34 mm ² , Ø 4.9 mm	TPU / Brass	50 AC 60 DC	-25...90	IP 65 / IP 67 / IP 68 / IP 69K	–	20	EVC299

Group 59 · Jumper , plug: M8, 4-pole, socket: M12, 5-pole, 4-wire, LED, PNP · Wiring diagram no. 4

	0.3 m black PUR cable	4 x 0.34 mm ² , Ø 4.9 mm	TPU / Brass	10...36 DC	-25...90	IP 65 / IP 67 / IP 68 / IP 69K	green / 2 x yellow	21	EVC290
	0.6 m black PUR cable	4 x 0.34 mm ² , Ø 4.9 mm	TPU / Brass	10...36 DC	-25...90	IP 65 / IP 67 / IP 68 / IP 69K	green / 2 x yellow	21	EVC291
	1 m black PUR cable	4 x 0.34 mm ² , Ø 4.9 mm	TPU / Brass	10...36 DC	-25...90	IP 65 / IP 67 / IP 68 / IP 69K	green / 2 x yellow	21	EVC292
	2 m black PUR cable	4 x 0.34 mm ² , Ø 4.9 mm	TPU / Brass	10...36 DC	-25...90	IP 65 / IP 67 / IP 68 / IP 69K	green / 2 x yellow	21	EVC293
	5 m black PUR cable	4 x 0.34 mm ² , Ø 4.9 mm	TPU / Brass	10...36 DC	-25...90	IP 65 / IP 67 / IP 68 / IP 69K	green / 2 x yellow	21	EVC294

M12 – M12 jumpers for industrial applications

Type	Cable	Wire specification	Material housing / nut	U [V]	T _a [°C]	Protection	LEDs	Drawing no.	Order no.
------	-------	--------------------	------------------------	-------	---------------------	------------	------	-------------	-----------

Group 60 · Jumper , plug: M12, 3-pole, socket: M12, 5-pole, 3-wire · Wiring diagram no. 1

	0.3 m black PUR cable	3 x 0.34 mm ² , Ø 4.9 mm	TPU / Brass	250 AC 300 DC	-25...90	IP 65 / IP 67 / IP 68 / IP 69K	–	22	EVC045
---	-----------------------	-------------------------------------	-------------	------------------	----------	-----------------------------------	---	----	---------------

Type	Cable	Wire specification	Material housing / nut	U [V]	T _a [°C]	Protection	LEDs	Drawing no.	Order no.
Group 60 · Jumper , plug: M12, 3-pole, socket: M12, 5-pole, 3-wire · Wiring diagram no. 1									
	0.6 m black PUR cable	3 x 0.34 mm ² , Ø 4.9 mm	TPU / Brass	250 AC 300 DC	-25...90	IP 65 / IP 67 / IP 68 / IP 69K	–	22	EVC046
	1 m black PUR cable	3 x 0.34 mm ² , Ø 4.9 mm	TPU / Brass	250 AC 300 DC	-25...90	IP 65 / IP 67 / IP 68 / IP 69K	–	22	EVC047
	2 m black PUR cable	3 x 0.34 mm ² , Ø 4.9 mm	TPU / Brass	250 AC 300 DC	-25...90	IP 65 / IP 67 / IP 68 / IP 69K	–	22	EVC048
	5 m black PUR cable	3 x 0.34 mm ² , Ø 4.9 mm	TPU / Brass	250 AC 300 DC	-25...90	IP 65 / IP 67 / IP 68 / IP 69K	–	22	EVC049
	0.3 m black PUR cable	3 x 0.34 mm ² , Ø 4.9 mm	TPU / Brass	250 AC 300 DC	-25...90	IP 65 / IP 67 / IP 68 / IP 69K	–	23	EVC040
	0.6 m black PUR cable	3 x 0.34 mm ² , Ø 4.9 mm	TPU / Brass	250 AC 300 DC	-25...90	IP 65 / IP 67 / IP 68 / IP 69K	–	23	EVC041
	1 m black PUR cable	3 x 0.34 mm ² , Ø 4.9 mm	TPU / Brass	250 AC 300 DC	-25...90	IP 65 / IP 67 / IP 68 / IP 69K	–	23	EVC042
	2 m black PUR cable	3 x 0.34 mm ² , Ø 4.9 mm	TPU / Brass	250 AC 300 DC	-25...90	IP 65 / IP 67 / IP 68 / IP 69K	–	23	EVC043
	5 m black PUR cable	3 x 0.34 mm ² , Ø 4.9 mm	TPU / Brass	250 AC 300 DC	-25...90	IP 65 / IP 67 / IP 68 / IP 69K	–	23	EVC044
Group 62 · Jumper , plug: M12, 3-pole, socket: M12, 5-pole, 3-wire, LED, PNP · Wiring diagram no. 2									
	0.3 m black PUR cable	3 x 0.34 mm ² , Ø 4.9 mm	TPU / Brass	10...36 DC	-25...90	IP 65 / IP 67 / IP 68 / IP 69K	green / yellow	24	EVC050
	0.6 m black PUR cable	3 x 0.34 mm ² , Ø 4.9 mm	TPU / Brass	10...36 DC	-25...90	IP 65 / IP 67 / IP 68 / IP 69K	green / yellow	24	EVC051
	1 m black PUR cable	3 x 0.34 mm ² , Ø 4.9 mm	TPU / Brass	10...36 DC	-25...90	IP 65 / IP 67 / IP 68 / IP 69K	green / yellow	24	EVC052
	2 m black PUR cable	3 x 0.34 mm ² , Ø 4.9 mm	TPU / Brass	10...36 DC	-25...90	IP 65 / IP 67 / IP 68 / IP 69K	green / yellow	24	EVC053
	5 m black PUR cable	3 x 0.34 mm ² , Ø 4.9 mm	TPU / Brass	10...36 DC	-25...90	IP 65 / IP 67 / IP 68 / IP 69K	green / yellow	24	EVC054



Connection technology

Type	Cable	Wire specification	Material housing / nut	U [V]	T _a [°C]	Protection	LEDs	Drawing no.	Order no.
Group 64 · Jumper , plug: M12, 4-pole, socket: M12, 5/4-pole, 4-wire · Wiring diagram no. 3									
	0.3 m black PUR cable	4 x 0.34 mm ² , Ø 4.9 mm	TPU / Brass	250 AC 300 DC	-25...90	IP 65 / IP 67 / IP 68 / IP 69K	–	25	EVC015
	0.6 m black PUR cable	4 x 0.34 mm ² , Ø 4.9 mm	TPU / Brass	250 AC 300 DC	-25...90	IP 65 / IP 67 / IP 68 / IP 69K	–	25	EVC016
	1 m black PUR cable	4 x 0.34 mm ² , Ø 4.9 mm	TPU / Brass	250 AC 300 DC	-25...90	IP 65 / IP 67 / IP 68 / IP 69K	–	25	EVC017
	2 m black PUR cable	4 x 0.34 mm ² , Ø 4.9 mm	TPU / Brass	250 AC 300 DC	-25...90	IP 65 / IP 67 / IP 68 / IP 69K	–	25	EVC018
	5 m black PUR cable	4 x 0.34 mm ² , Ø 4.9 mm	TPU / Brass	250 AC 300 DC	-25...90	IP 65 / IP 67 / IP 68 / IP 69K	–	25	EVC019
	0.3 m black PUR cable	4 x 0.34 mm ² , Ø 4.9 mm	TPU / Brass	250 AC 300 DC	-25...90	IP 65 / IP 67 / IP 68 / IP 69K	–	26	EVC010
	0.6 m black PUR cable	4 x 0.34 mm ² , Ø 4.9 mm	TPU / Brass	250 AC 300 DC	-25...90	IP 65 / IP 67 / IP 68 / IP 69K	–	26	EVC011
	1 m black PUR cable	4 x 0.34 mm ² , Ø 4.9 mm	TPU / Brass	250 AC 300 DC	-25...90	IP 65 / IP 67 / IP 68 / IP 69K	–	26	EVC012
	2 m black PUR cable	4 x 0.34 mm ² , Ø 4.9 mm	TPU / Brass	250 AC 300 DC	-25...90	IP 65 / IP 67 / IP 68 / IP 69K	–	26	EVC013
	5 m black PUR cable	4 x 0.34 mm ² , Ø 4.9 mm	TPU / Brass	250 AC 300 DC	-25...90	IP 65 / IP 67 / IP 68 / IP 69K	–	26	EVC014
Group 66 · Jumper , plug: M12, 4-pole, socket: M12, 5/4-pole, 4-wire, LED, PNP · Wiring diagram no. 4									
	0.3 m black PUR cable	4 x 0.34 mm ² , Ø 4.9 mm	TPU / Brass	10...36 DC	-25...90	IP 65 / IP 67 / IP 68 / IP 69K	green / 2 x yellow	27	EVC020
	0.6 m black PUR cable	4 x 0.34 mm ² , Ø 4.9 mm	TPU / Brass	10...36 DC	-25...90	IP 65 / IP 67 / IP 68 / IP 69K	green / 2 x yellow	27	EVC021
	1 m black PUR cable	4 x 0.34 mm ² , Ø 4.9 mm	TPU / Brass	10...36 DC	-25...90	IP 65 / IP 67 / IP 68 / IP 69K	green / 2 x yellow	27	EVC022
	2 m black PUR cable	4 x 0.34 mm ² , Ø 4.9 mm	TPU / Brass	10...36 DC	-25...90	IP 65 / IP 67 / IP 68 / IP 69K	green / 2 x yellow	27	EVC023

Type	Cable	Wire specification	Material housing / nut	U [V]	T _a [°C]	Protection	LEDs	Drawing no.	Order no.
------	-------	--------------------	------------------------	-------	---------------------	------------	------	-------------	-----------

Group 66 · Jumper , plug: M12, 4-pole, socket: M12, 5/4-pole, 4-wire, LED, PNP · Wiring diagram no. 4



5 m black PUR cable	4 x 0.34 mm ² , Ø 4.9 mm	TPU / Brass	10...36 DC	-25...90	IP 65 / IP 67 / IP 68 / IP 69K	green / 2 x yellow	27	EVC024
---------------------	-------------------------------------	-------------	------------	----------	--------------------------------	--------------------	----	---------------

Group 67 · Jumper , plug: M12, 4-pole, socket: M12, 5/4-pole, 4-wire · Wiring diagram no. 3



0.3 m black PUR cable	4 x 0.34 mm ² , Ø 4.9 mm	TPU / Brass	250 AC 300 DC	-25...90	IP 65 / IP 67 / IP 68 / IP 69K	–	28	EVC025
0.6 m black PUR cable	4 x 0.34 mm ² , Ø 4.9 mm	TPU / Brass	250 AC 300 DC	-25...90	IP 65 / IP 67 / IP 68 / IP 69K	–	28	EVC026
1 m black PUR cable	4 x 0.34 mm ² , Ø 4.9 mm	TPU / Brass	250 AC 300 DC	-25...90	IP 65 / IP 67 / IP 68 / IP 69K	–	28	EVC027
2 m black PUR cable	4 x 0.34 mm ² , Ø 4.9 mm	TPU / Brass	250 AC 300 DC	-25...90	IP 65 / IP 67 / IP 68 / IP 69K	–	28	EVC028
5 m black PUR cable	4 x 0.34 mm ² , Ø 4.9 mm	TPU / Brass	250 AC 300 DC	-25...90	IP 65 / IP 67 / IP 68 / IP 69K	–	28	EVC029



0.3 m black PUR cable	4 x 0.34 mm ² , Ø 4.9 mm	TPU / Brass	250 AC 300 DC	-25...90	IP 65 / IP 67 / IP 68 / IP 69K	–	29	EVC030
0.6 m black PUR cable	4 x 0.34 mm ² , Ø 4.9 mm	TPU / Brass	250 AC 300 DC	-25...90	IP 65 / IP 67 / IP 68 / IP 69K	–	29	EVC031
1 m black PUR cable	4 x 0.34 mm ² , Ø 4.9 mm	TPU / Brass	250 AC 300 DC	-25...90	IP 65 / IP 67 / IP 68 / IP 69K	–	29	EVC032
2 m black PUR cable	4 x 0.34 mm ² , Ø 4.9 mm	TPU / Brass	250 AC 300 DC	-25...90	IP 65 / IP 67 / IP 68 / IP 69K	–	29	EVC033
5 m black PUR cable	4 x 0.34 mm ² , Ø 4.9 mm	TPU / Brass	250 AC 300 DC	-25...90	IP 65 / IP 67 / IP 68 / IP 69K	–	29	EVC034

Group 68 · Jumper , plug: M12, 4-pole, socket: M12, 5/4-pole, 4-wire, LED, PNP · Wiring diagram no. 4



0.3 m black PUR cable	4 x 0.34 mm ² , Ø 4.9 mm	TPU / Brass	10...36 DC	-25...90	IP 65 / IP 67 / IP 68 / IP 69K	green / 2 x yellow	30	EVC035
0.6 m black PUR cable	4 x 0.34 mm ² , Ø 4.9 mm	TPU / Brass	10...36 DC	-25...90	IP 65 / IP 67 / IP 68 / IP 69K	green / 2 x yellow	30	EVC036
1 m black PUR cable	4 x 0.34 mm ² , Ø 4.9 mm	TPU / Brass	10...36 DC	-25...90	IP 65 / IP 67 / IP 68 / IP 69K	green / 2 x yellow	30	EVC037













Connection technology



Type	Cable	Wire specification	Material housing / nut	U [V]	T _a [°C]	Protection	LEDs	Drawing no.	Order no.
Group 68 · Jumper , plug: M12, 4-pole, socket: M12, 5/4-pole, 4-wire, LED, PNP · Wiring diagram no. 4									
	2 m black PUR cable	4 x 0.34 mm ² , Ø 4.9 mm	TPU / Brass	10...36 DC	-25...90	IP 65 / IP 67 / IP 68 / IP 69K	green / 2 x yellow	30	EVC038
	5 m black PUR cable	4 x 0.34 mm ² , Ø 4.9 mm	TPU / Brass	10...36 DC	-25...90	IP 65 / IP 67 / IP 68 / IP 69K	green / 2 x yellow	30	EVC039
Group 69 · Jumper , plug: M12, 5-pole, socket: M12, 5-pole, 5-wire · Wiring diagram no. 5									
	0.3 m black PUR cable	5 x 0.34 mm ² , Ø 4.9 mm	TPU / Brass	60 AC 60 DC	-25...90	IP 65 / IP 67 / IP 68 / IP 69K	–	31	EVC060
	0.6 m black PUR cable	5 x 0.34 mm ² , Ø 4.9 mm	TPU / Brass	60 AC 60 DC	-25...90	IP 65 / IP 67 / IP 68 / IP 69K	–	31	EVC061
	1 m black PUR cable	5 x 0.34 mm ² , Ø 4.9 mm	TPU / Brass	60 AC 60 DC	-25...90	IP 65 / IP 67 / IP 68 / IP 69K	–	31	EVC062
	2 m black PUR cable	5 x 0.34 mm ² , Ø 4.9 mm	TPU / Brass	60 AC 60 DC	-25...90	IP 65 / IP 67 / IP 68 / IP 69K	–	31	EVC063
	5 m black PUR cable	5 x 0.34 mm ² , Ø 4.9 mm	TPU / Brass	60 AC 60 DC	-25...90	IP 65 / IP 67 / IP 68 / IP 69K	–	31	EVC064
	0.3 m black PUR cable	5 x 0.34 mm ² , Ø 4.9 mm	TPU / Brass	60 AC 60 DC	-25...90	IP 65 / IP 67 / IP 68 / IP 69K	–	32	EVC055
	0.6 m black PUR cable	5 x 0.34 mm ² , Ø 4.9 mm	TPU / Brass	60 AC 60 DC	-25...90	IP 65 / IP 67 / IP 68 / IP 69K	–	32	EVC056
	1 m black PUR cable	5 x 0.34 mm ² , Ø 4.9 mm	TPU / Brass	60 AC 60 DC	-25...90	IP 65 / IP 67 / IP 68 / IP 69K	–	32	EVC057
	2 m black PUR cable	5 x 0.34 mm ² , Ø 4.9 mm	TPU / Brass	60 AC 60 DC	-25...90	IP 65 / IP 67 / IP 68 / IP 69K	–	32	EVC058
	5 m black PUR cable	5 x 0.34 mm ² , Ø 4.9 mm	TPU / Brass	60 AC 60 DC	-25...90	IP 65 / IP 67 / IP 68 / IP 69K	–	32	EVC059
	0.3 m black PUR cable	5 x 0.34 mm ² , Ø 4.9 mm	TPU / Brass	60 AC 60 DC	-25...90	IP 65 / IP 67 / IP 68 / IP 69K	–	33	EVC065
	0.6 m black PUR cable	5 x 0.34 mm ² , Ø 4.9 mm	TPU / Brass	60 AC 60 DC	-25...90	IP 65 / IP 67 / IP 68 / IP 69K	–	33	EVC066

Type	Cable	Wire specification	Material housing / nut	U [V]	T _a [°C]	Protection	LEDs	Drawing no.	Order no.
Group 69 · Jumper , plug: M12, 5-pole, socket: M12, 5-pole, 5-wire · Wiring diagram no. 5									
	1 m black PUR cable	5 x 0.34 mm ² , Ø 4.9 mm	TPU / Brass	60 AC 60 DC	-25...90	IP 65 / IP 67 / IP 68 / IP 69K	–	33	EVC067
	2 m black PUR cable	5 x 0.34 mm ² , Ø 4.9 mm	TPU / Brass	60 AC 60 DC	-25...90	IP 65 / IP 67 / IP 68 / IP 69K	–	33	EVC068
	5 m black PUR cable	5 x 0.34 mm ² , Ø 4.9 mm	TPU / Brass	60 AC 60 DC	-25...90	IP 65 / IP 67 / IP 68 / IP 69K	–	33	EVC069
Group 70 · Jumper , plug: M12, 4-pole, socket: M12, 5/4-pole, 4-wire · Wiring diagram no. 3									
	0.25 m black PUR cable	4 x 1.00 mm ² , Ø 6.2 mm	TPU / Brass	250 AC 300 DC	-25...90	IP 65 / IP 67 / IP 68 / IP 69K	–	26	EVC716
	0.5 m black PUR cable	4 x 1.00 mm ² , Ø 6.2 mm	TPU / Brass	250 AC 300 DC	-25...90	IP 65 / IP 67 / IP 68 / IP 69K	–	26	EVC717
	1 m black PUR cable	4 x 1.00 mm ² , Ø 6.2 mm	TPU / Brass	250 AC 300 DC	-25...90	IP 65 / IP 67 / IP 68 / IP 69K	–	26	EVC718
	2 m black PUR cable	4 x 1.00 mm ² , Ø 6.2 mm	TPU / Brass	250 AC 300 DC	-25...90	IP 65 / IP 67 / IP 68 / IP 69K	–	26	EVC719
	5 m black PUR cable	4 x 1.00 mm ² , Ø 6.2 mm	TPU / Brass	250 AC 300 DC	-25...90	IP 65 / IP 67 / IP 68 / IP 69K	–	26	EVC720
	10 m black PUR cable	4 x 1.00 mm ² , Ø 6.2 mm	TPU / Brass	250 AC 300 DC	-25...90	IP 65 / IP 67 / IP 68 / IP 69K	–	26	EVC721
	20 m black PUR cable	4 x 1.00 mm ² , Ø 6.2 mm	TPU / Brass	250 AC 300 DC	-25...90	IP 65 / IP 67 / IP 68 / IP 69K	–	26	EVC722
	0.25 m black PUR cable	4 x 1.00 mm ² , Ø 6.2 mm	TPU / Brass	250 AC 300 DC	-25...90	IP 65 / IP 67 / IP 68 / IP 69K	–	25	EVC723
	0.5 m black PUR cable	4 x 1.00 mm ² , Ø 6.2 mm	TPU / Brass	250 AC 300 DC	-25...90	IP 65 / IP 67 / IP 68 / IP 69K	–	25	EVC724
	1 m black PUR cable	4 x 1.00 mm ² , Ø 6.2 mm	TPU / Brass	250 AC 300 DC	-25...90	IP 65 / IP 67 / IP 68 / IP 69K	–	25	EVC725
	2 m black PUR cable	4 x 1.00 mm ² , Ø 6.2 mm	TPU / Brass	250 AC 300 DC	-25...90	IP 65 / IP 67 / IP 68 / IP 69K	–	25	EVC726

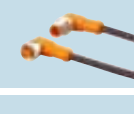
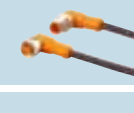

Connection technology

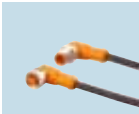
Type	Cable	Wire specification	Material housing / nut	U [V]	T _a [°C]	Protection	LEDs	Drawing no.	Order no.
Group 70 · Jumper , plug: M12, 4-pole, socket: M12, 5/4-pole, 4-wire · Wiring diagram no. 3									
	5 m black PUR cable	4 x 1.00 mm ² , Ø 6.2 mm	TPU / Brass	250 AC 300 DC	-25...90	IP 65 / IP 67 / IP 68 / IP 69K	–	25	EVC727
	10 m black PUR cable	4 x 1.00 mm ² , Ø 6.2 mm	TPU / Brass	250 AC 300 DC	-25...90	IP 65 / IP 67 / IP 68 / IP 69K	–	25	EVC728
	20 m black PUR cable	4 x 1.00 mm ² , Ø 6.2 mm	TPU / Brass	250 AC 300 DC	-25...90	IP 65 / IP 67 / IP 68 / IP 69K	–	25	EVC729
	0.25 m black PUR cable	4 x 1.00 mm ² , Ø 6.2 mm	TPU / Brass	250 AC 300 DC	-25...90	IP 65 / IP 67 / IP 68 / IP 69K	–	28	EVC730
	0.5 m black PUR cable	4 x 1.00 mm ² , Ø 6.2 mm	TPU / Brass	250 AC 300 DC	-25...90	IP 65 / IP 67 / IP 68 / IP 69K	–	28	EVC731
	1 m black PUR cable	4 x 1.00 mm ² , Ø 6.2 mm	TPU / Brass	250 AC 300 DC	-25...90	IP 65 / IP 67 / IP 68 / IP 69K	–	28	EVC732
	2 m black PUR cable	4 x 1.00 mm ² , Ø 6.2 mm	TPU / Brass	250 AC 300 DC	-25...90	IP 65 / IP 67 / IP 68 / IP 69K	–	28	EVC733
	5 m black PUR cable	4 x 1.00 mm ² , Ø 6.2 mm	TPU / Brass	250 AC 300 DC	-25...90	IP 65 / IP 67 / IP 68 / IP 69K	–	28	EVC734
	10 m black PUR cable	4 x 1.00 mm ² , Ø 6.2 mm	TPU / Brass	250 AC 300 DC	-25...90	IP 65 / IP 67 / IP 68 / IP 69K	–	28	EVC735
	20 m black PUR cable	4 x 1.00 mm ² , Ø 6.2 mm	TPU / Brass	250 AC 300 DC	-25...90	IP 65 / IP 67 / IP 68 / IP 69K	–	28	EVC736
	0.25 m black PUR cable	4 x 1.00 mm ² , Ø 6.2 mm	TPU / Brass	250 AC 300 DC	-25...90	IP 65 / IP 67 / IP 68 / IP 69K	–	29	EVC737
	0.5 m black PUR cable	4 x 1.00 mm ² , Ø 6.2 mm	TPU / Brass	250 AC 300 DC	-25...90	IP 65 / IP 67 / IP 68 / IP 69K	–	29	EVC738
	1 m black PUR cable	4 x 1.00 mm ² , Ø 6.2 mm	TPU / Brass	250 AC 300 DC	-25...90	IP 65 / IP 67 / IP 68 / IP 69K	–	29	EVC739
	2 m black PUR cable	4 x 1.00 mm ² , Ø 6.2 mm	TPU / Brass	250 AC 300 DC	-25...90	IP 65 / IP 67 / IP 68 / IP 69K	–	29	EVC740

Type	Cable	Wire specification	Material housing / nut	U [V]	T _a [°C]	Protection	LEDs	Drawing no.	Order no.
Group 70 · Jumper , plug: M12, 4-pole, socket: M12, 5/4-pole, 4-wire · Wiring diagram no. 3									
	5 m black PUR cable	4 x 1.00 mm ² , Ø 6.2 mm	TPU / Brass	250 AC 300 DC	-25...90	IP 65 / IP 67 / IP 68 / IP 69K	–	29	EVC741
	10 m black PUR cable	4 x 1.00 mm ² , Ø 6.2 mm	TPU / Brass	250 AC 300 DC	-25...90	IP 65 / IP 67 / IP 68 / IP 69K	–	29	EVC742
	20 m black PUR cable	4 x 1.00 mm ² , Ø 6.2 mm	TPU / Brass	250 AC 300 DC	-25...90	IP 65 / IP 67 / IP 68 / IP 69K	–	29	EVC743

Valve - plug jumpers for industrial applications

Type	Cable	Wire specification	Material housing / nut	U [V]	T _a [°C]	Protection	LEDs	Drawing no.	Order no.
Group 71 · Jumper , plug: M12, 3-pole, valve plug: Housing A, 4-pole, 3-wire, LED · Wiring diagram no. 6									
	0.3 m black PUR cable	3 x 0.5 mm ² , Ø 5 mm	PUR / Brass	24 AC/DC	-25...80	IP 67	yellow	34	E11416
	0.6 m black PUR cable	3 x 0.5 mm ² , Ø 5 mm	PUR / Brass	24 AC/DC	-25...80	IP 67	yellow	34	E11417
	1 m black PUR cable	3 x 0.5 mm ² , Ø 5 mm	PUR / Brass	24 AC/DC	-25...80	IP 67	yellow	34	E11418
	2 m black PUR cable	3 x 0.5 mm ² , Ø 5 mm	PUR / Brass	24 AC/DC	-25...80	IP 67	yellow	34	E11419
	5 m black PUR cable	3 x 0.5 mm ² , Ø 5 mm	PUR / Brass	24 AC/DC	-25...80	IP 67	yellow	34	E11420
Group 72 · Jumper , plug: M12, 3-pole, valve plug: Housing B, 3-pole, 3-wire, LED · Wiring diagram no. 7									
	0.3 m black PUR cable	3 x 0.5 mm ² , Ø 5 mm	PUR / Brass	24 AC/DC	-25...80	IP 67	yellow	35	E11421
	0.6 m black PUR cable	3 x 0.5 mm ² , Ø 5 mm	PUR / Brass	24 AC/DC	-25...80	IP 67	yellow	35	E11422
	1 m black PUR cable	3 x 0.5 mm ² , Ø 5 mm	PUR / Brass	24 AC/DC	-25...80	IP 67	yellow	35	E11423
	2 m black PUR cable	3 x 0.5 mm ² , Ø 5 mm	PUR / Brass	24 AC/DC	-25...80	IP 67	yellow	35	E11424



Connection technology

Type	Cable	Wire specification	Material housing / nut	U [V]	T _a [°C]	Protection	LEDs	Drawing no.	Order no.
------	-------	--------------------	------------------------	-------	---------------------	------------	------	-------------	-----------

Group 72 · Jumper , plug: M12, 3-pole, valve plug: Housing B, 3-pole, 3-wire, LED · Wiring diagram no. 7



5 m black PUR cable	3 x 0.5 mm ² , Ø 5 mm	PUR / Brass	24 AC/DC	-25...80	IP 67	yellow	35	E11425
---------------------	----------------------------------	-------------	----------	----------	-------	--------	----	---------------

Group 73 · Jumper , plug: M12, 3-pole, valve plug: Housing B (industrial standard), 3-pole, 3-wire, LED · Wiring diagram no. 7



0.3 m black PUR cable	3 x 0.5 mm ² , Ø 5 mm	PUR / Brass	24 AC/DC	-25...80	IP 67	yellow	36	E11431
-----------------------	----------------------------------	-------------	----------	----------	-------	--------	----	---------------

0.6 m black PUR cable	3 x 0.5 mm ² , Ø 5 mm	PUR / Brass	24 AC/DC	-25...80	IP 67	yellow	36	E11432
-----------------------	----------------------------------	-------------	----------	----------	-------	--------	----	---------------

1 m black PUR cable	3 x 0.5 mm ² , Ø 5 mm	PUR / Brass	24 AC/DC	-25...80	IP 67	yellow	36	E11433
---------------------	----------------------------------	-------------	----------	----------	-------	--------	----	---------------

2 m black PUR cable	3 x 0.5 mm ² , Ø 5 mm	PUR / Brass	24 AC/DC	-25...80	IP 67	yellow	36	E11434
---------------------	----------------------------------	-------------	----------	----------	-------	--------	----	---------------

5 m black PUR cable	3 x 0.5 mm ² , Ø 5 mm	PUR / Brass	24 AC/DC	-25...80	IP 67	yellow	36	E11435
---------------------	----------------------------------	-------------	----------	----------	-------	--------	----	---------------

Group 74 · Jumper , plug: M12, 3-pole, valve plug: Housing C, 4-pole, 3-wire, LED · Wiring diagram no. 6



0.3 m black PUR cable	3 x 0.5 mm ² , Ø 5 mm	PUR / Brass	24 AC/DC	-25...80	IP 65	yellow	37	E11426
-----------------------	----------------------------------	-------------	----------	----------	-------	--------	----	---------------

0.6 m black PUR cable	3 x 0.5 mm ² , Ø 5 mm	PUR / Brass	24 AC/DC	-25...80	IP 65	yellow	37	E11427
-----------------------	----------------------------------	-------------	----------	----------	-------	--------	----	---------------

1 m black PUR cable	3 x 0.5 mm ² , Ø 5 mm	PUR / Brass	24 AC/DC	-25...80	IP 65	yellow	37	E11428
---------------------	----------------------------------	-------------	----------	----------	-------	--------	----	---------------

2 m black PUR cable	3 x 0.5 mm ² , Ø 5 mm	PUR / Brass	24 AC/DC	-25...80	IP 65	yellow	37	E11429
---------------------	----------------------------------	-------------	----------	----------	-------	--------	----	---------------

5 m black PUR cable	3 x 0.5 mm ² , Ø 5 mm	PUR / Brass	24 AC/DC	-25...80	IP 65	yellow	37	E11430
---------------------	----------------------------------	-------------	----------	----------	-------	--------	----	---------------

Group 75 · Jumper , plug: M12, 3-pole, valve plug: Housing C (industrial standard), 4-pole, 3-wire, LED · Wiring diagram no. 6



0.3 m black PUR cable	3 x 0.5 mm ² , Ø 5 mm	PUR / Brass	24 AC/DC	-25...80	IP 67	yellow	38	E11436
-----------------------	----------------------------------	-------------	----------	----------	-------	--------	----	---------------

0.6 m black PUR cable	3 x 0.5 mm ² , Ø 5 mm	PUR / Brass	24 AC/DC	-25...80	IP 67	yellow	38	E11437
-----------------------	----------------------------------	-------------	----------	----------	-------	--------	----	---------------

Type	Cable	Wire specification	Material housing / nut	U [V]	T _a [°C]	Protection	LEDs	Drawing no.	Order no.
------	-------	--------------------	------------------------	-------	---------------------	------------	------	-------------	-----------



Group 75 · Jumper , plug: M12, 3-pole, valve plug: Housing C (industrial standard), 4-pole, 3-wire, LED · Wiring diagram no. 6

	1 m black PUR cable	3 x 0.5 mm ² , Ø 5 mm	PUR / Brass	24 AC/DC	-25...80	IP 67	yellow	38	E11438
	2 m black PUR cable	3 x 0.5 mm ² , Ø 5 mm	PUR / Brass	24 AC/DC	-25...80	IP 67	yellow	38	E11439
	5 m black PUR cable	3 x 0.5 mm ² , Ø 5 mm	PUR / Brass	24 AC/DC	-25...80	IP 67	yellow	38	E11440

Jumpers weld slag resistant

Type	Cable	Wire specification	Material housing / nut	U [V]	T _a [°C]	Protection	LEDs	Drawing no.	Order no.
------	-------	--------------------	------------------------	-------	---------------------	------------	------	-------------	-----------

Group 142 · Jumper , plug: M12, 4-pole, socket: M12, 5-pole, 4-wire · Wiring diagram no. 3

	0.3 m grey PUR cable	4 x 0.34 mm ² , Ø 4.9 mm	TPU / Brass	250 AC 300 DC	-25...90	IP 65 / IP 67 / IP 68 / IP 69K	-	39	EVW036
	0.5 m grey PUR cable	4 x 0.34 mm ² , Ø 4.9 mm	TPU / Brass	250 AC 300 DC	-25...90	IP 65 / IP 67 / IP 68 / IP 69K	-	39	EVW022
	1 m grey PUR cable	4 x 0.34 mm ² , Ø 4.9 mm	TPU / Brass	250 AC 300 DC	-25...90	IP 65 / IP 67 / IP 68 / IP 69K	-	39	EVW030
	2 m grey PUR cable	4 x 0.34 mm ² , Ø 4.9 mm	TPU / Brass	250 AC 300 DC	-25...90	IP 65 / IP 67 / IP 68 / IP 69K	-	39	EVW031
	5 m grey PUR cable	4 x 0.34 mm ² , Ø 4.9 mm	TPU / Brass	250 AC 300 DC	-25...90	IP 65 / IP 67 / IP 68 / IP 69K	-	39	EVW034
	10 m grey PUR cable	4 x 0.34 mm ² , Ø 4.9 mm	TPU / Brass	250 AC 300 DC	-25...90	IP 65 / IP 67 / IP 68 / IP 69K	-	39	EVW035
	0.3 m grey PUR cable	4 x 0.34 mm ² , Ø 4.9 mm	TPU / Brass	250 AC 300 DC	-25...90	IP 65 / IP 67 / IP 68 / IP 69K	-	40	EVW037
	0.5 m grey PUR cable	4 x 0.34 mm ² , Ø 4.9 mm	TPU / Brass	250 AC 300 DC	-25...90	IP 65 / IP 67 / IP 68 / IP 69K	-	40	EVW023
	1 m grey PUR cable	4 x 0.34 mm ² , Ø 4.9 mm	TPU / Brass	250 AC 300 DC	-25...90	IP 65 / IP 67 / IP 68 / IP 69K	-	40	EVW024
	2 m grey PUR cable	4 x 0.34 mm ² , Ø 4.9 mm	TPU / Brass	250 AC 300 DC	-25...90	IP 65 / IP 67 / IP 68 / IP 69K	-	40	EVW025





Connection technology

Type	Cable	Wire specification	Material housing / nut	U [V]	T _a [°C]	Protection	LEDs	Drawing no.	Order no.
Group 142 · Jumper , plug: M12, 4-pole, socket: M12, 5-pole, 4-wire · Wiring diagram no. 3									
	5 m grey PUR cable	4 x 0.34 mm ² , Ø 4.9 mm	TPU / Brass	250 AC 300 DC	-25...90	IP 65 / IP 67 / IP 68 / IP 69K	–	40	EVW028
	10 m grey PUR cable	4 x 0.34 mm ² , Ø 4.9 mm	TPU / Brass	250 AC 300 DC	-25...90	IP 65 / IP 67 / IP 68 / IP 69K	–	40	EVW029
Group 143 · Jumper , plug: M12, 5-pole, socket: M12, 5-pole, 4-wire · Wiring diagram no. 5									
	0.3 m grey PUR cable	5 x 0.34 mm ² , Ø 5.1 mm	TPU / Brass	60 AC 60 DC	-25...90	IP 65 / IP 67 / IP 68 / IP 69K	–	31	EVW054
	0.6 m grey PUR cable	5 x 0.34 mm ² , Ø 5.1 mm	TPU / Brass	60 AC 60 DC	-25...90	IP 65 / IP 67 / IP 68 / IP 69K	–	31	EVW055
	1 m grey PUR cable	5 x 0.34 mm ² , Ø 5.1 mm	TPU / Brass	60 AC 60 DC	-25...90	IP 65 / IP 67 / IP 68 / IP 69K	–	31	EVW056
	2 m grey PUR cable	5 x 0.34 mm ² , Ø 5.1 mm	TPU / Brass	60 AC 60 DC	-25...90	IP 65 / IP 67 / IP 68 / IP 69K	–	31	EVW057
	5 m grey PUR cable	5 x 0.34 mm ² , Ø 5.1 mm	TPU / Brass	60 AC 60 DC	-25...90	IP 65 / IP 67 / IP 68 / IP 69K	–	31	EVW058
	10 m grey PUR cable	5 x 0.34 mm ² , Ø 5.1 mm	TPU / Brass	60 AC 60 DC	-25...90	IP 65 / IP 67 / IP 68 / IP 69K	–	31	EVW059
	0.3 m grey PUR cable	5 x 0.34 mm ² , Ø 5.1 mm	TPU / Brass	60 AC 60 DC	-25...90	IP 65 / IP 67 / IP 68 / IP 69K	–	32	EVW048
	0.6 m grey PUR cable	5 x 0.34 mm ² , Ø 5.1 mm	TPU / Brass	60 AC 60 DC	-25...90	IP 65 / IP 67 / IP 68 / IP 69K	–	32	EVW049
	1 m grey PUR cable	5 x 0.34 mm ² , Ø 5.1 mm	TPU / Brass	60 AC 60 DC	-25...90	IP 65 / IP 67 / IP 68 / IP 69K	–	32	EVW050
	2 m grey PUR cable	5 x 0.34 mm ² , Ø 5.1 mm	TPU / Brass	60 AC 60 DC	-25...90	IP 65 / IP 67 / IP 68 / IP 69K	–	32	EVW051
	5 m grey PUR cable	5 x 0.34 mm ² , Ø 5.1 mm	TPU / Brass	60 AC 60 DC	-25...90	IP 65 / IP 67 / IP 68 / IP 69K	–	32	EVW052
	10 m grey PUR cable	5 x 0.34 mm ² , Ø 5.1 mm	TPU / Brass	60 AC 60 DC	-25...90	IP 65 / IP 67 / IP 68 / IP 69K	–	32	EVW053

Type	Cable	Wire specification	Material housing / nut	U [V]	T _a [°C]	Protection	LEDs	Drawing no.	Order no.
------	-------	--------------------	------------------------	-------	---------------------	------------	------	-------------	-----------

Group 144 · Jumper , plug: M12, 4-pole, socket: M12, 5-pole, 4-wire, LED, PNP · Wiring diagram no. 4

	1 m grey PUR cable	4 x 0.34 mm ² , Ø 4.9 mm	TPU / Brass	10...36 DC	-25...90	IP 65 / IP 67 / IP 68 / IP 69K	green / 2 x yellow	41	EVW038
	2 m grey PUR cable	4 x 0.34 mm ² , Ø 4.9 mm	TPU / Brass	10...36 DC	-25...90	IP 65 / IP 67 / IP 68 / IP 69K	green / 2 x yellow	41	EVW039
	5 m grey PUR cable	4 x 0.34 mm ² , Ø 4.9 mm	TPU / Brass	10...36 DC	-25...90	IP 65 / IP 67 / IP 68 / IP 69K	green / 2 x yellow	41	EVW041
	10 m grey PUR cable	4 x 0.34 mm ² , Ø 4.9 mm	TPU / Brass	10...36 DC	-25...90	IP 65 / IP 67 / IP 68 / IP 69K	green / 2 x yellow	41	EVW042
	1 m grey PUR cable	4 x 0.34 mm ² , Ø 4.9 mm	TPU / Brass	10...36 DC	-25...90	IP 65 / IP 67 / IP 68 / IP 69K	green / 2 x yellow	42	EVW043
	2 m grey PUR cable	4 x 0.34 mm ² , Ø 4.9 mm	TPU / Brass	10...36 DC	-25...90	IP 65 / IP 67 / IP 68 / IP 69K	green / 2 x yellow	42	EVW044
	3 m grey PUR cable	4 x 0.34 mm ² , Ø 4.9 mm	TPU / Brass	10...36 DC	-25...90	IP 65 / IP 67 / IP 68 / IP 69K	green / 2 x yellow	42	EVW045
	5 m grey PUR cable	4 x 0.34 mm ² , Ø 4.9 mm	TPU / Brass	10...36 DC	-25...90	IP 65 / IP 67 / IP 68 / IP 69K	green / 2 x yellow	42	EVW046
	10 m grey PUR cable	4 x 0.34 mm ² , Ø 4.9 mm	TPU / Brass	10...36 DC	-25...90	IP 65 / IP 67 / IP 68 / IP 69K	green / 2 x yellow	42	EVW047

Jumpers for hygienic and wet areas

Type	Cable	Wire specification	Material housing / nut	U [V]	T _a [°C]	Protection	LEDs	Drawing no.	Order no.
------	-------	--------------------	------------------------	-------	---------------------	------------	------	-------------	-----------

Group 161 · Jumper , plug: M8, 3-pole, socket: M8, 3-pole, 3-wire · Wiring diagram no. 1

	0.3 m orange PVC cable	3 x 0.34 mm ² , Ø 4.9 mm	PVC / stainless steel 316L / 1.4404	50 AC 60 DC	-25...80	IP 65 / IP 67 / IP 68 / IP 69K	-	43	EVT142
	0.6 m orange PVC cable	3 x 0.34 mm ² , Ø 4.9 mm	PVC / stainless steel 316L / 1.4404	50 AC 60 DC	-25...80	IP 65 / IP 67 / IP 68 / IP 69K	-	43	EVT143
	1 m orange PVC cable	3 x 0.34 mm ² , Ø 4.9 mm	PVC / stainless steel 316L / 1.4404	50 AC 60 DC	-25...80	IP 65 / IP 67 / IP 68 / IP 69K	-	43	EVT144
	2 m orange PVC cable	3 x 0.34 mm ² , Ø 4.9 mm	PVC / stainless steel 316L / 1.4404	50 AC 60 DC	-25...80	IP 65 / IP 67 / IP 68 / IP 69K	-	43	EVT145





Connection technology

Type	Cable	Wire specification	Material housing / nut	U [V]	T _a [°C]	Protection	LEDs	Drawing no.	Order no.
Group 161 · Jumper , plug: M8, 3-pole, socket: M8, 3-pole, 3-wire · Wiring diagram no. 1									
	5 m orange PVC cable	3 x 0.34 mm ² , Ø 4.9 mm	PVC / stainless steel 316L / 1.4404	50 AC 60 DC	-25...80	IP 65 / IP 67 / IP 68 / IP 69K	-	43	EVT146
	10 m orange PVC cable	3 x 0.34 mm ² , Ø 4.9 mm	PVC / stainless steel 316L / 1.4404	50 AC 60 DC	-25...80	IP 65 / IP 67 / IP 68 / IP 69K	-	43	EVT147
	0.3 m orange PVC cable	3 x 0.34 mm ² , Ø 4.9 mm	PVC / stainless steel 316L / 1.4404	50 AC 60 DC	-25...80	IP 65 / IP 67 / IP 68 / IP 69K	-	44	EVT148
	0.6 m orange PVC cable	3 x 0.34 mm ² , Ø 4.9 mm	PVC / stainless steel 316L / 1.4404	50 AC 60 DC	-25...80	IP 65 / IP 67 / IP 68 / IP 69K	-	44	EVT149
	1 m orange PVC cable	3 x 0.34 mm ² , Ø 4.9 mm	PVC / stainless steel 316L / 1.4404	50 AC 60 DC	-25...80	IP 65 / IP 67 / IP 68 / IP 69K	-	44	EVT150
	2 m orange PVC cable	3 x 0.34 mm ² , Ø 4.9 mm	PVC / stainless steel 316L / 1.4404	50 AC 60 DC	-25...80	IP 65 / IP 67 / IP 68 / IP 69K	-	44	EVT151
	5 m orange PVC cable	3 x 0.34 mm ² , Ø 4.9 mm	PVC / stainless steel 316L / 1.4404	50 AC 60 DC	-25...80	IP 65 / IP 67 / IP 68 / IP 69K	-	44	EVT152
	10 m orange PVC cable	3 x 0.34 mm ² , Ø 4.9 mm	PVC / stainless steel 316L / 1.4404	50 AC 60 DC	-25...80	IP 65 / IP 67 / IP 68 / IP 69K	-	44	EVT153
Group 163 · Jumper , plug: M8, 3-pole, socket: M8, 3-pole, 3-wire, LED, PNP · Wiring diagram no. 2									
	0.3 m orange PVC cable	3 x 0.34 mm ² , Ø 4.9 mm	PVC / stainless steel 316L / 1.4404	10...36 DC	-25...80	IP 65 / IP 67 / IP 68 / IP 69K	green / yellow	45	EVT154
	0.6 m orange PVC cable	3 x 0.34 mm ² , Ø 4.9 mm	PVC / stainless steel 316L / 1.4404	10...36 DC	-25...80	IP 65 / IP 67 / IP 68 / IP 69K	green / yellow	45	EVT155
	1 m orange PVC cable	3 x 0.34 mm ² , Ø 4.9 mm	PVC / stainless steel 316L / 1.4404	10...36 DC	-25...80	IP 65 / IP 67 / IP 68 / IP 69K	green / yellow	45	EVT156
	2 m orange PVC cable	3 x 0.34 mm ² , Ø 4.9 mm	PVC / stainless steel 316L / 1.4404	10...36 DC	-25...80	IP 65 / IP 67 / IP 68 / IP 69K	green / yellow	45	EVT157
	5 m orange PVC cable	3 x 0.34 mm ² , Ø 4.9 mm	PVC / stainless steel 316L / 1.4404	10...36 DC	-25...80	IP 65 / IP 67 / IP 68 / IP 69K	green / yellow	45	EVT158
	10 m orange PVC cable	3 x 0.34 mm ² , Ø 4.9 mm	PVC / stainless steel 316L / 1.4404	10...36 DC	-25...80	IP 65 / IP 67 / IP 68 / IP 69K	green / yellow	45	EVT159

Type	Cable	Wire specification	Material housing / nut	U [V]	T _a [°C]	Protection	LEDs	Drawing no.	Order no.
------	-------	--------------------	------------------------	-------	---------------------	------------	------	-------------	-----------

Group 165 · Jumper , plug: M8, 3-pole, socket: M8, 3-pole, 3-wire · Wiring diagram no. 1

	0.3 m orange PVC cable	3 x 0.34 mm ² , Ø 4.9 mm	PVC / stainless steel 316L / 1.4404	50 AC 60 DC	-25...80	IP 65 / IP 67 / IP 68 / IP 69K	-	46	EVT160
	0.6 m orange PVC cable	3 x 0.34 mm ² , Ø 4.9 mm	PVC / stainless steel 316L / 1.4404	50 AC 60 DC	-25...80	IP 65 / IP 67 / IP 68 / IP 69K	-	46	EVT161
	1 m orange PVC cable	3 x 0.34 mm ² , Ø 4.9 mm	PVC / stainless steel 316L / 1.4404	50 AC 60 DC	-25...80	IP 65 / IP 67 / IP 68 / IP 69K	-	46	EVT162
	2 m orange PVC cable	3 x 0.34 mm ² , Ø 4.9 mm	PVC / stainless steel 316L / 1.4404	50 AC 60 DC	-25...80	IP 65 / IP 67 / IP 68 / IP 69K	-	46	EVT163
	5 m orange PVC cable	3 x 0.34 mm ² , Ø 4.9 mm	PVC / stainless steel 316L / 1.4404	50 AC 60 DC	-25...80	IP 65 / IP 67 / IP 68 / IP 69K	-	46	EVT164
	10 m orange PVC cable	3 x 0.34 mm ² , Ø 4.9 mm	PVC / stainless steel 316L / 1.4404	50 AC 60 DC	-25...80	IP 65 / IP 67 / IP 68 / IP 69K	-	46	EVT165

	0.3 m orange PVC cable	3 x 0.34 mm ² , Ø 4.9 mm	PVC / stainless steel 316L / 1.4404	50 AC 60 DC	-25...80	IP 65 / IP 67 / IP 68 / IP 69K	-	47	EVT166
	0.6 m orange PVC cable	3 x 0.34 mm ² , Ø 4.9 mm	PVC / stainless steel 316L / 1.4404	50 AC 60 DC	-25...80	IP 65 / IP 67 / IP 68 / IP 69K	-	47	EVT167
	1 m orange PVC cable	3 x 0.34 mm ² , Ø 4.9 mm	PVC / stainless steel 316L / 1.4404	50 AC 60 DC	-25...80	IP 65 / IP 67 / IP 68 / IP 69K	-	47	EVT168
	2 m orange PVC cable	3 x 0.34 mm ² , Ø 4.9 mm	PVC / stainless steel 316L / 1.4404	50 AC 60 DC	-25...80	IP 65 / IP 67 / IP 68 / IP 69K	-	47	EVT169
	5 m orange PVC cable	3 x 0.34 mm ² , Ø 4.9 mm	PVC / stainless steel 316L / 1.4404	50 AC 60 DC	-25...80	IP 65 / IP 67 / IP 68 / IP 69K	-	47	EVT170
	10 m orange PVC cable	3 x 0.34 mm ² , Ø 4.9 mm	PVC / stainless steel 316L / 1.4404	50 AC 60 DC	-25...80	IP 65 / IP 67 / IP 68 / IP 69K	-	47	EVT171

Group 166 · Jumper , plug: M8, 3-pole, socket: M8, 3-pole, 3-wire, LED, PNP · Wiring diagram no. 2

	0.3 m orange PVC cable	3 x 0.34 mm ² , Ø 4.9 mm	PVC / stainless steel 316L / 1.4404	10...36 DC	-25...80	IP 65 / IP 67 / IP 68 / IP 69K	green / yellow	48	EVT172
	0.6 m orange PVC cable	3 x 0.34 mm ² , Ø 4.9 mm	PVC / stainless steel 316L / 1.4404	10...36 DC	-25...80	IP 65 / IP 67 / IP 68 / IP 69K	green / yellow	48	EVT173
	1 m orange PVC cable	3 x 0.34 mm ² , Ø 4.9 mm	PVC / stainless steel 316L / 1.4404	10...36 DC	-25...80	IP 65 / IP 67 / IP 68 / IP 69K	green / yellow	48	EVT174

You can find wiring diagrams and scale drawings from page 828





Connection technology

Type	Cable	Wire specification	Material housing / nut	U [V]	T _a [°C]	Protection	LEDs	Drawing no.	Order no.
Group 166 · Jumper , plug: M8, 3-pole, socket: M8, 3-pole, 3-wire, LED, PNP · Wiring diagram no. 2									
	2 m orange PVC cable	3 x 0.34 mm ² , Ø 4.9 mm	PVC / stainless steel 316L / 1.4404	10...36 DC	-25...80	IP 65 / IP 67 / IP 68 / IP 69K	green / yellow	48	EVT175
	5 m orange PVC cable	3 x 0.34 mm ² , Ø 4.9 mm	PVC / stainless steel 316L / 1.4404	10...36 DC	-25...80	IP 65 / IP 67 / IP 68 / IP 69K	green / yellow	48	EVT176
	10 m orange PVC cable	3 x 0.34 mm ² , Ø 4.9 mm	PVC / stainless steel 316L / 1.4404	10...36 DC	-25...80	IP 65 / IP 67 / IP 68 / IP 69K	green / yellow	48	EVT177
Group 167 · Jumper , plug: M8, 3-pole, socket: M8, 4-pole, 3-wire · Wiring diagram no. 1									
	0.3 m orange PVC cable	3 x 0.34 mm ² , Ø 4.9 mm	PVC / stainless steel 316L / 1.4404	50 AC 60 DC	-25...80	IP 65 / IP 67 / IP 68 / IP 69K	–	49	EVT279
	0.6 m orange PVC cable	3 x 0.34 mm ² , Ø 4.9 mm	PVC / stainless steel 316L / 1.4404	50 AC 60 DC	-25...80	IP 65 / IP 67 / IP 68 / IP 69K	–	49	EVT280
	1 m orange PVC cable	3 x 0.34 mm ² , Ø 4.9 mm	PVC / stainless steel 316L / 1.4404	50 AC 60 DC	-25...80	IP 65 / IP 67 / IP 68 / IP 69K	–	49	EVT281
	2 m orange PVC cable	3 x 0.34 mm ² , Ø 4.9 mm	PVC / stainless steel 316L / 1.4404	50 AC 60 DC	-25...80	IP 65 / IP 67 / IP 68 / IP 69K	–	49	EVT203
	5 m orange PVC cable	3 x 0.34 mm ² , Ø 4.9 mm	PVC / stainless steel 316L / 1.4404	50 AC 60 DC	-25...80	IP 65 / IP 67 / IP 68 / IP 69K	–	49	EVT204
	0.3 m orange PVC cable	3 x 0.34 mm ² , Ø 4.9 mm	PVC / stainless steel 316L / 1.4404	50 AC 60 DC	-25...80	IP 65 / IP 67 / IP 68 / IP 69K	–	50	EVT283
	0.6 m orange PVC cable	3 x 0.34 mm ² , Ø 4.9 mm	PVC / stainless steel 316L / 1.4404	50 AC 60 DC	-25...80	IP 65 / IP 67 / IP 68 / IP 69K	–	50	EVT284
	1 m orange PVC cable	3 x 0.34 mm ² , Ø 4.9 mm	PVC / stainless steel 316L / 1.4404	50 AC 60 DC	-25...80	IP 65 / IP 67 / IP 68 / IP 69K	–	50	EVT285
	2 m orange PVC cable	3 x 0.34 mm ² , Ø 4.9 mm	PVC / stainless steel 316L / 1.4404	50 AC 60 DC	-25...80	IP 65 / IP 67 / IP 68 / IP 69K	–	50	EVT211
	5 m orange PVC cable	3 x 0.34 mm ² , Ø 4.9 mm	PVC / stainless steel 316L / 1.4404	50 AC 60 DC	-25...80	IP 65 / IP 67 / IP 68 / IP 69K	–	50	EVT286
Group 168 · Jumper , plug: M8, 3-pole, socket: M12, 5-pole, 3-wire · Wiring diagram no. 1									
	0.3 m orange PVC cable	3 x 0.34 mm ² , Ø 4.9 mm	PVC / stainless steel 316L / 1.4404	50 AC 60 DC	-25...80	IP 65 / IP 67 / IP 68 / IP 69K	–	51	EVT260

Type	Cable	Wire specification	Material housing / nut	U [V]	T _a [°C]	Protection	LEDs	Drawing no.	Order no.
------	-------	--------------------	------------------------	-------	---------------------	------------	------	-------------	-----------

Group 168 · Jumper , plug: M8, 3-pole, socket: M12, 5-pole, 3-wire · Wiring diagram no. 1

	0.6 m orange PVC cable	3 x 0.34 mm ² , Ø 4.9 mm	PVC / stainless steel 316L / 1.4404	50 AC 60 DC	-25...80	IP 65 / IP 67 / IP 68 / IP 69K	-	51	EVT261
	1 m orange PVC cable	3 x 0.34 mm ² , Ø 4.9 mm	PVC / stainless steel 316L / 1.4404	50 AC 60 DC	-25...80	IP 65 / IP 67 / IP 68 / IP 69K	-	51	EVT262
	2 m orange PVC cable	3 x 0.34 mm ² , Ø 4.9 mm	PVC / stainless steel 316L / 1.4404	50 AC 60 DC	-25...80	IP 65 / IP 67 / IP 68 / IP 69K	-	51	EVT263
	0.3 m orange PVC cable	3 x 0.34 mm ² , Ø 4.9 mm	PVC / stainless steel 316L / 1.4404	50 AC 60 DC	-25...80	IP 65 / IP 67 / IP 68 / IP 69K	-	52	EVT265
	0.6 m orange PVC cable	3 x 0.34 mm ² , Ø 4.9 mm	PVC / stainless steel 316L / 1.4404	50 AC 60 DC	-25...80	IP 65 / IP 67 / IP 68 / IP 69K	-	52	EVT266
	1 m orange PVC cable	3 x 0.34 mm ² , Ø 4.9 mm	PVC / stainless steel 316L / 1.4404	50 AC 60 DC	-25...80	IP 65 / IP 67 / IP 68 / IP 69K	-	52	EVT267
	2 m orange PVC cable	3 x 0.34 mm ² , Ø 4.9 mm	PVC / stainless steel 316L / 1.4404	50 AC 60 DC	-25...80	IP 65 / IP 67 / IP 68 / IP 69K	-	52	EVT268
	5 m orange PVC cable	3 x 0.34 mm ² , Ø 4.9 mm	PVC / stainless steel 316L / 1.4404	50 AC 60 DC	-25...80	IP 65 / IP 67 / IP 68 / IP 69K	-	52	EVT269
	10 m orange PVC cable	3 x 0.34 mm ² , Ø 4.9 mm	PVC / stainless steel 316L / 1.4404	50 AC 60 DC	-25...80	IP 65 / IP 67 / IP 68 / IP 69K	-	52	EVT270

Group 169 · Jumper , plug: M8, 4-pole, socket: M8, 4-pole, 4-wire · Wiring diagram no. 3

	0.3 m orange PVC cable	4 x 0.34 mm ² , Ø 4.9 mm	PVC / stainless steel 316L / 1.4404	50 AC 60 DC	-25...80	IP 65 / IP 67 / IP 68 / IP 69K	-	53	EVT178
	0.6 m orange PVC cable	4 x 0.34 mm ² , Ø 4.9 mm	PVC / stainless steel 316L / 1.4404	50 AC 60 DC	-25...80	IP 65 / IP 67 / IP 68 / IP 69K	-	53	EVT179
	1 m orange PVC cable	4 x 0.34 mm ² , Ø 4.9 mm	PVC / stainless steel 316L / 1.4404	50 AC 60 DC	-25...80	IP 65 / IP 67 / IP 68 / IP 69K	-	53	EVT180
	2 m orange PVC cable	4 x 0.34 mm ² , Ø 4.9 mm	PVC / stainless steel 316L / 1.4404	50 AC 60 DC	-25...80	IP 65 / IP 67 / IP 68 / IP 69K	-	53	EVT181
	5 m orange PVC cable	4 x 0.34 mm ² , Ø 4.9 mm	PVC / stainless steel 316L / 1.4404	50 AC 60 DC	-25...80	IP 65 / IP 67 / IP 68 / IP 69K	-	53	EVT182
	10 m orange PVC cable	4 x 0.34 mm ² , Ø 4.9 mm	PVC / stainless steel 316L / 1.4404	50 AC 60 DC	-25...80	IP 65 / IP 67 / IP 68 / IP 69K	-	53	EVT183

You can find wiring diagrams and scale drawings from page 828



Connection technology

Type	Cable	Wire specification	Material housing / nut	U [V]	T _a [°C]	Protection	LEDs	Drawing no.	Order no.
Group 169 · Jumper , plug: M8, 4-pole, socket: M8, 4-pole, 4-wire · Wiring diagram no. 3									
	0.3 m orange PVC cable	4 x 0.34 mm ² , Ø 4.9 mm	PVC / stainless steel 316L / 1.4404	50 AC 60 DC	-25...80	IP 65 / IP 67 / IP 68 / IP 69K	–	54	EVT184
	0.6 m orange PVC cable	4 x 0.34 mm ² , Ø 4.9 mm	PVC / stainless steel 316L / 1.4404	50 AC 60 DC	-25...80	IP 65 / IP 67 / IP 68 / IP 69K	–	54	EVT185
	1 m orange PVC cable	4 x 0.34 mm ² , Ø 4.9 mm	PVC / stainless steel 316L / 1.4404	50 AC 60 DC	-25...80	IP 65 / IP 67 / IP 68 / IP 69K	–	54	EVT186
	2 m orange PVC cable	4 x 0.34 mm ² , Ø 4.9 mm	PVC / stainless steel 316L / 1.4404	50 AC 60 DC	-25...80	IP 65 / IP 67 / IP 68 / IP 69K	–	54	EVT187
	5 m orange PVC cable	4 x 0.34 mm ² , Ø 4.9 mm	PVC / stainless steel 316L / 1.4404	50 AC 60 DC	-25...80	IP 65 / IP 67 / IP 68 / IP 69K	–	54	EVT188
	10 m orange PVC cable	4 x 0.34 mm ² , Ø 4.9 mm	PVC / stainless steel 316L / 1.4404	50 AC 60 DC	-25...80	IP 65 / IP 67 / IP 68 / IP 69K	–	54	EVT189
	0.3 m orange PVC cable	4 x 0.34 mm ² , Ø 4.9 mm	PVC / stainless steel 316L / 1.4404	50 AC 60 DC	-25...80	IP 65 / IP 67 / IP 68 / IP 69K	–	55	EVT190
	0.6 m orange PVC cable	4 x 0.34 mm ² , Ø 4.9 mm	PVC / stainless steel 316L / 1.4404	50 AC 60 DC	-25...80	IP 65 / IP 67 / IP 68 / IP 69K	–	55	EVT191
	1 m orange PVC cable	4 x 0.34 mm ² , Ø 4.9 mm	PVC / stainless steel 316L / 1.4404	50 AC 60 DC	-25...80	IP 65 / IP 67 / IP 68 / IP 69K	–	55	EVT192
	2 m orange PVC cable	4 x 0.34 mm ² , Ø 4.9 mm	PVC / stainless steel 316L / 1.4404	50 AC 60 DC	-25...80	IP 65 / IP 67 / IP 68 / IP 69K	–	55	EVT193
	5 m orange PVC cable	4 x 0.34 mm ² , Ø 4.9 mm	PVC / stainless steel 316L / 1.4404	50 AC 60 DC	-25...80	IP 65 / IP 67 / IP 68 / IP 69K	–	55	EVT194
	10 m orange PVC cable	4 x 0.34 mm ² , Ø 4.9 mm	PVC / stainless steel 316L / 1.4404	50 AC 60 DC	-25...80	IP 65 / IP 67 / IP 68 / IP 69K	–	55	EVT195
	0.3 m orange PVC cable	4 x 0.34 mm ² , Ø 4.9 mm	PVC / stainless steel 316L / 1.4404	50 AC 60 DC	-25...80	IP 65 / IP 67 / IP 68 / IP 69K	–	56	EVT196
	0.6 m orange PVC cable	4 x 0.34 mm ² , Ø 4.9 mm	PVC / stainless steel 316L / 1.4404	50 AC 60 DC	-25...80	IP 65 / IP 67 / IP 68 / IP 69K	–	56	EVT197
	1 m orange PVC cable	4 x 0.34 mm ² , Ø 4.9 mm	PVC / stainless steel 316L / 1.4404	50 AC 60 DC	-25...80	IP 65 / IP 67 / IP 68 / IP 69K	–	56	EVT198

Type	Cable	Wire specification	Material housing / nut	U [V]	T _a [°C]	Protection	LEDs	Drawing no.	Order no.
Group 169 · Jumper , plug: M8, 4-pole, socket: M8, 4-pole, 4-wire · Wiring diagram no. 3									
	2 m orange PVC cable	4 x 0.34 mm ² , Ø 4.9 mm	PVC / stainless steel 316L / 1.4404	50 AC 60 DC	-25...80	IP 65 / IP 67 / IP 68 / IP 69K	–	56	EVT199
	5 m orange PVC cable	4 x 0.34 mm ² , Ø 4.9 mm	PVC / stainless steel 316L / 1.4404	50 AC 60 DC	-25...80	IP 65 / IP 67 / IP 68 / IP 69K	–	56	EVT200
	10 m orange PVC cable	4 x 0.34 mm ² , Ø 4.9 mm	PVC / stainless steel 316L / 1.4404	50 AC 60 DC	-25...80	IP 65 / IP 67 / IP 68 / IP 69K	–	56	EVT201
Group 170 · Jumper , plug: M12, 4-pole, socket: M12, 5/4-pole, 4-wire · halogen-free · Wiring diagram no. 3									
	0.3 m grey MPPE cable	4 x 0.34 mm ² , Ø 4.9 mm	PP / stainless steel 316L / 1.4404	250 AC 300 DC	-25...100	IP 65 / IP 67 / IP 68 / IP 69K	–	57	EVF040
	0.6 m grey MPPE cable	4 x 0.34 mm ² , Ø 4.9 mm	PP / stainless steel 316L / 1.4404	250 AC 300 DC	-25...100	IP 65 / IP 67 / IP 68 / IP 69K	–	57	EVF041
	1 m grey MPPE cable	4 x 0.34 mm ² , Ø 4.9 mm	PP / stainless steel 316L / 1.4404	250 AC 300 DC	-25...100	IP 65 / IP 67 / IP 68 / IP 69K	–	57	EVF042
	2 m grey MPPE cable	4 x 0.34 mm ² , Ø 4.9 mm	PP / stainless steel 316L / 1.4404	250 AC 300 DC	-25...100	IP 65 / IP 67 / IP 68 / IP 69K	–	57	EVF043
	5 m grey MPPE cable	4 x 0.34 mm ² , Ø 4.9 mm	PP / stainless steel 316L / 1.4404	250 AC 300 DC	-25...100	IP 65 / IP 67 / IP 68 / IP 69K	–	57	EVF044
	10 m grey MPPE cable	4 x 0.34 mm ² , Ø 4.9 mm	PP / stainless steel 316L / 1.4404	250 AC 300 DC	-25...100	IP 65 / IP 67 / IP 68 / IP 69K	–	57	EVF045
	0.3 m grey MPPE cable	4 x 0.34 mm ² , Ø 4.9 mm	PP / stainless steel 316L / 1.4404	250 AC 300 DC	-25...100	IP 65 / IP 67 / IP 68 / IP 69K	–	58	EVF046
	0.6 m grey MPPE cable	4 x 0.34 mm ² , Ø 4.9 mm	PP / stainless steel 316L / 1.4404	250 AC 300 DC	-25...100	IP 65 / IP 67 / IP 68 / IP 69K	–	58	EVF047
	1 m grey MPPE cable	4 x 0.34 mm ² , Ø 4.9 mm	PP / stainless steel 316L / 1.4404	250 AC 300 DC	-25...100	IP 65 / IP 67 / IP 68 / IP 69K	–	58	EVF048
	2 m grey MPPE cable	4 x 0.34 mm ² , Ø 4.9 mm	PP / stainless steel 316L / 1.4404	250 AC 300 DC	-25...100	IP 65 / IP 67 / IP 68 / IP 69K	–	58	EVF049
	5 m grey MPPE cable	4 x 0.34 mm ² , Ø 4.9 mm	PP / stainless steel 316L / 1.4404	250 AC 300 DC	-25...100	IP 65 / IP 67 / IP 68 / IP 69K	–	58	EVF050









Connection technology

Type	Cable	Wire specification	Material housing / nut	U [V]	T _a [°C]	Protection	LEDs	Drawing no.	Order no.
------	-------	--------------------	------------------------	-------	---------------------	------------	------	-------------	-----------

Group 170 · Jumper , plug: M12, 4-pole, socket: M12, 5/4-pole, 4-wire · halogen-free · Wiring diagram no. 3

	10 m grey MPPE cable	4 x 0.34 mm ² , Ø 4.9 mm	PP / stainless steel 316L / 1.4404	250 AC 300 DC	-25...100	IP 65 / IP 67 / IP 68 / IP 69K	–	58	EVF051
---	----------------------	-------------------------------------	------------------------------------	------------------	-----------	--------------------------------	---	----	---------------

Group 171 · Jumper , plug: M12, 4-pole, socket: M12, 5/4-pole, 4-wire, LED, PNP · halogen-free · Wiring diagram no. 4

	0.3 m grey MPPE cable	4 x 0.34 mm ² , Ø 4.9 mm	PP / stainless steel 316L / 1.4404	10...36 DC	-25...100	IP 65 / IP 67 / IP 68 / IP 69K	green / 2 x yellow	59	EVF052
	0.6 m grey MPPE cable	4 x 0.34 mm ² , Ø 4.9 mm	PP / stainless steel 316L / 1.4404	10...36 DC	-25...100	IP 65 / IP 67 / IP 68 / IP 69K	green / 2 x yellow	59	EVF053
	1 m grey MPPE cable	4 x 0.34 mm ² , Ø 4.9 mm	PP / stainless steel 316L / 1.4404	10...36 DC	-25...100	IP 65 / IP 67 / IP 68 / IP 69K	green / 2 x yellow	59	EVF054
	2 m grey MPPE cable	4 x 0.34 mm ² , Ø 4.9 mm	PP / stainless steel 316L / 1.4404	10...36 DC	-25...100	IP 65 / IP 67 / IP 68 / IP 69K	green / 2 x yellow	59	EVF055
	5 m grey MPPE cable	4 x 0.34 mm ² , Ø 4.9 mm	PP / stainless steel 316L / 1.4404	10...36 DC	-25...100	IP 65 / IP 67 / IP 68 / IP 69K	green / 2 x yellow	59	EVF056
	10 m grey MPPE cable	4 x 0.34 mm ² , Ø 4.9 mm	PP / stainless steel 316L / 1.4404	10...36 DC	-25...100	IP 65 / IP 67 / IP 68 / IP 69K	green / 2 x yellow	59	EVF057



Jumpers for hygienic and wet areas

Type	Cable	Wire specification	Material housing / nut	U [V]	T _a [°C]	Protection	LEDs	Drawing no.	Order no.
------	-------	--------------------	------------------------	-------	---------------------	------------	------	-------------	-----------

Group 172 · Jumper , plug: M12, 3-pole, socket: M8, 3-pole, 3-wire · Wiring diagram no. 1

	0.3 m orange PVC cable	3 x 0.34 mm ² , Ø 4.9 mm	PVC / stainless steel 316L / 1.4404	50 AC 60 DC	-25...80	IP 65 / IP 67 / IP 68 / IP 69K	–	60	EVT236
	0.6 m orange PVC cable	3 x 0.34 mm ² , Ø 4.9 mm	PVC / stainless steel 316L / 1.4404	50 AC 60 DC	-25...80	IP 65 / IP 67 / IP 68 / IP 69K	–	60	EVT237
	1 m orange PVC cable	3 x 0.34 mm ² , Ø 4.9 mm	PVC / stainless steel 316L / 1.4404	50 AC 60 DC	-25...80	IP 65 / IP 67 / IP 68 / IP 69K	–	60	EVT238
	2 m orange PVC cable	3 x 0.34 mm ² , Ø 4.9 mm	PVC / stainless steel 316L / 1.4404	50 AC 60 DC	-25...80	IP 65 / IP 67 / IP 68 / IP 69K	–	60	EVT239
	5 m orange PVC cable	3 x 0.34 mm ² , Ø 4.9 mm	PVC / stainless steel 316L / 1.4404	50 AC 60 DC	-25...80	IP 65 / IP 67 / IP 68 / IP 69K	–	60	EVT240

Type	Cable	Wire specification	Material housing / nut	U [V]	T _a [°C]	Protection	LEDs	Drawing no.	Order no.
Group 172 · Jumper , plug: M12, 3-pole, socket: M8, 3-pole, 3-wire · Wiring diagram no. 1									
	0.3 m orange PVC cable	3 x 0.34 mm ² , Ø 4.9 mm	PVC / stainless steel 316L / 1.4404	50 AC 60 DC	-25...80	IP 65 / IP 67 / IP 68 / IP 69K	-	61	EVT242
	0.6 m orange PVC cable	3 x 0.34 mm ² , Ø 4.9 mm	PVC / stainless steel 316L / 1.4404	50 AC 60 DC	-25...80	IP 65 / IP 67 / IP 68 / IP 69K	-	61	EVT243
	1 m orange PVC cable	3 x 0.34 mm ² , Ø 4.9 mm	PVC / stainless steel 316L / 1.4404	50 AC 60 DC	-25...80	IP 65 / IP 67 / IP 68 / IP 69K	-	61	EVT244
	2 m orange PVC cable	3 x 0.34 mm ² , Ø 4.9 mm	PVC / stainless steel 316L / 1.4404	50 AC 60 DC	-25...80	IP 65 / IP 67 / IP 68 / IP 69K	-	61	EVT245
	5 m orange PVC cable	3 x 0.34 mm ² , Ø 4.9 mm	PVC / stainless steel 316L / 1.4404	50 AC 60 DC	-25...80	IP 65 / IP 67 / IP 68 / IP 69K	-	61	EVT246

Group 173 · Jumper , plug: M12, 3-pole, socket: M12, 5/4/3-pole, 3-wire · Wiring diagram no. 1									
	0.3 m orange PVC cable	3 x 0.34 mm ² , Ø 4.9 mm	PVC / stainless steel 316L / 1.4404	250 AC 300 DC	-25...100	IP 65 / IP 67 / IP 68 / IP 69K	-	62	EVT028
	0.6 m orange PVC cable	3 x 0.34 mm ² , Ø 4.9 mm	PVC / stainless steel 316L / 1.4404	250 AC 300 DC	-25...100	IP 65 / IP 67 / IP 68 / IP 69K	-	62	EVT029
	1 m orange PVC cable	3 x 0.34 mm ² , Ø 4.9 mm	PVC / stainless steel 316L / 1.4404	250 AC 300 DC	-25...100	IP 65 / IP 67 / IP 68 / IP 69K	-	62	EVT030
	2 m orange PVC cable	3 x 0.34 mm ² , Ø 4.9 mm	PVC / stainless steel 316L / 1.4404	250 AC 300 DC	-25...100	IP 65 / IP 67 / IP 68 / IP 69K	-	62	EVT031
	5 m orange PVC cable	3 x 0.34 mm ² , Ø 4.9 mm	PVC / stainless steel 316L / 1.4404	250 AC 300 DC	-25...100	IP 65 / IP 67 / IP 68 / IP 69K	-	62	EVT032
	10 m orange PVC cable	3 x 0.34 mm ² , Ø 4.9 mm	PVC / stainless steel 316L / 1.4404	250 AC 300 DC	-25...100	IP 65 / IP 67 / IP 68 / IP 69K	-	62	EVT033
	0.3 m orange PVC cable	3 x 0.34 mm ² , Ø 4.9 mm	PVC / stainless steel 316L / 1.4404	250 AC 300 DC	-25...100	IP 65 / IP 67 / IP 68 / IP 69K	-	63	EVT022
	0.6 m orange PVC cable	3 x 0.34 mm ² , Ø 4.9 mm	PVC / stainless steel 316L / 1.4404	250 AC 300 DC	-25...100	IP 65 / IP 67 / IP 68 / IP 69K	-	63	EVT023
	1 m orange PVC cable	3 x 0.34 mm ² , Ø 4.9 mm	PVC / stainless steel 316L / 1.4404	250 AC 300 DC	-25...100	IP 65 / IP 67 / IP 68 / IP 69K	-	63	EVT024
	2 m orange PVC cable	3 x 0.34 mm ² , Ø 4.9 mm	PVC / stainless steel 316L / 1.4404	250 AC 300 DC	-25...100	IP 65 / IP 67 / IP 68 / IP 69K	-	63	EVT025

You can find wiring diagrams and scale drawings from page 828





Connection technology

Type	Cable	Wire specification	Material housing / nut	U [V]	T _a [°C]	Protection	LEDs	Drawing no.	Order no.
Group 173 · Jumper , plug: M12, 3-pole, socket: M12, 5/4/3-pole, 3-wire · Wiring diagram no. 1									
	5 m orange PVC cable	3 x 0.34 mm ² , Ø 4.9 mm	PVC / stainless steel 316L / 1.4404	250 AC 300 DC	-25...100	IP 65 / IP 67 / IP 68 / IP 69K	–	63	EVT026
	10 m orange PVC cable	3 x 0.34 mm ² , Ø 4.9 mm	PVC / stainless steel 316L / 1.4404	250 AC 300 DC	-25...100	IP 65 / IP 67 / IP 68 / IP 69K	–	63	EVT027
Group 174 · Jumper , plug: M12, 3-pole, socket: M12, 5/4/3-pole, 3-wire, LED, PNP · Wiring diagram no. 2									
	0.3 m orange PVC cable	3 x 0.34 mm ² , Ø 4.9 mm	PVC / stainless steel 316L / 1.4404	10...36 DC	-25...100	IP 65 / IP 67 / IP 68 / IP 69K	green / yellow	64	EVT034
	0.6 m orange PVC cable	3 x 0.34 mm ² , Ø 4.9 mm	PVC / stainless steel 316L / 1.4404	10...36 DC	-25...100	IP 65 / IP 67 / IP 68 / IP 69K	green / yellow	64	EVT035
	1 m orange PVC cable	3 x 0.34 mm ² , Ø 4.9 mm	PVC / stainless steel 316L / 1.4404	10...36 DC	-25...100	IP 65 / IP 67 / IP 68 / IP 69K	green / yellow	64	EVT036
	2 m orange PVC cable	3 x 0.34 mm ² , Ø 4.9 mm	PVC / stainless steel 316L / 1.4404	10...36 DC	-25...100	IP 65 / IP 67 / IP 68 / IP 69K	green / yellow	64	EVT037
	5 m orange PVC cable	3 x 0.34 mm ² , Ø 4.9 mm	PVC / stainless steel 316L / 1.4404	10...36 DC	-25...100	IP 65 / IP 67 / IP 68 / IP 69K	green / yellow	64	EVT038
	10 m orange PVC cable	3 x 0.34 mm ² , Ø 4.9 mm	PVC / stainless steel 316L / 1.4404	10...36 DC	-25...100	IP 65 / IP 67 / IP 68 / IP 69K	green / yellow	64	EVT039
Group 175 · Jumper , plug: M12, 3-pole, socket: M12, 5/4/3-pole, 3-wire · Wiring diagram no. 1									
	0.3 m orange PVC cable	3 x 0.34 mm ² , Ø 4.9 mm	PVC / stainless steel 316L / 1.4404	250 AC 300 DC	-25...100	IP 65 / IP 67 / IP 68 / IP 69K	–	65	EVT079
	0.6 m orange PVC cable	3 x 0.34 mm ² , Ø 4.9 mm	PVC / stainless steel 316L / 1.4404	250 AC 300 DC	-25...100	IP 65 / IP 67 / IP 68 / IP 69K	–	65	EVT110
	1 m orange PVC cable	3 x 0.34 mm ² , Ø 4.9 mm	PVC / stainless steel 316L / 1.4404	250 AC 300 DC	-25...100	IP 65 / IP 67 / IP 68 / IP 69K	–	65	EVT111
	2 m orange PVC cable	3 x 0.34 mm ² , Ø 4.9 mm	PVC / stainless steel 316L / 1.4404	250 AC 300 DC	-25...100	IP 65 / IP 67 / IP 68 / IP 69K	–	65	EVT112
	5 m orange PVC cable	3 x 0.34 mm ² , Ø 4.9 mm	PVC / stainless steel 316L / 1.4404	250 AC 300 DC	-25...100	IP 65 / IP 67 / IP 68 / IP 69K	–	65	EVT113
	10 m orange PVC cable	3 x 0.34 mm ² , Ø 4.9 mm	PVC / stainless steel 316L / 1.4404	250 AC 300 DC	-25...100	IP 65 / IP 67 / IP 68 / IP 69K	–	65	EVT114

Type	Cable	Wire specification	Material housing / nut	U [V]	T _a [°C]	Protection	LEDs	Drawing no.	Order no.
------	-------	--------------------	------------------------	-------	---------------------	------------	------	-------------	-----------

Group 176 · Jumper , plug: M12, 4-pole, socket: M8, 4-pole, 4-wire · Wiring diagram no. 3

	0.3 m orange PVC cable	4 x 0.34 mm ² , Ø 4.9 mm	PVC / stainless steel 316L / 1.4404	50 AC 60 DC	-25...80	IP 65 / IP 67 / IP 68 / IP 69K	-	66	EVT248
	0.6 m orange PVC cable	4 x 0.34 mm ² , Ø 4.9 mm	PVC / stainless steel 316L / 1.4404	50 AC 60 DC	-25...80	IP 65 / IP 67 / IP 68 / IP 69K	-	66	EVT249
	1 m orange PVC cable	4 x 0.34 mm ² , Ø 4.9 mm	PVC / stainless steel 316L / 1.4404	50 AC 60 DC	-25...80	IP 65 / IP 67 / IP 68 / IP 69K	-	66	EVT250
	5 m orange PVC cable	4 x 0.34 mm ² , Ø 4.9 mm	PVC / stainless steel 316L / 1.4404	50 AC 60 DC	-25...80	IP 65 / IP 67 / IP 68 / IP 69K	-	66	EVT251
	10 m orange PVC cable	4 x 0.34 mm ² , Ø 4.9 mm	PVC / stainless steel 316L / 1.4404	50 AC 60 DC	-25...80	IP 65 / IP 67 / IP 68 / IP 69K	-	66	EVT290

	0.3 m orange PVC cable	4 x 0.34 mm ² , Ø 4.9 mm	PVC / stainless steel 316L / 1.4404	50 AC 60 DC	-25...80	IP 65 / IP 67 / IP 68 / IP 69K	-	67	EVT253
	0.6 m orange PVC cable	4 x 0.34 mm ² , Ø 4.9 mm	PVC / stainless steel 316L / 1.4404	50 AC 60 DC	-25...80	IP 65 / IP 67 / IP 68 / IP 69K	-	67	EVT254
	1 m orange PVC cable	4 x 0.34 mm ² , Ø 4.9 mm	PVC / stainless steel 316L / 1.4404	50 AC 60 DC	-25...80	IP 65 / IP 67 / IP 68 / IP 69K	-	67	EVT255
	2 m orange PVC cable	4 x 0.34 mm ² , Ø 4.9 mm	PVC / stainless steel 316L / 1.4404	50 AC 60 DC	-25...80	IP 65 / IP 67 / IP 68 / IP 69K	-	67	EVT256
	5 m orange PVC cable	4 x 0.34 mm ² , Ø 4.9 mm	PVC / stainless steel 316L / 1.4404	50 AC 60 DC	-25...80	IP 65 / IP 67 / IP 68 / IP 69K	-	67	EVT257
	10 m orange PVC cable	4 x 0.34 mm ² , Ø 4.9 mm	PVC / stainless steel 316L / 1.4404	50 AC 60 DC	-25...80	IP 65 / IP 67 / IP 68 / IP 69K	-	67	EVT258

Group 177 · Jumper , plug: M12, 4-pole, socket: M12, 5/4-pole, 4-wire · Wiring diagram no. 3

	0.3 m orange PVC cable	4 x 0.34 mm ² , Ø 4.9 mm	PVC / stainless steel 316L / 1.4404	250 AC 300 DC	-25...100	IP 65 / IP 67 / IP 68 / IP 69K	-	58	EVT046
	0.6 m orange PVC cable	4 x 0.34 mm ² , Ø 4.9 mm	PVC / stainless steel 316L / 1.4404	250 AC 300 DC	-25...100	IP 65 / IP 67 / IP 68 / IP 69K	-	58	EVT047
	1 m orange PVC cable	4 x 0.34 mm ² , Ø 4.9 mm	PVC / stainless steel 316L / 1.4404	250 AC 300 DC	-25...100	IP 65 / IP 67 / IP 68 / IP 69K	-	58	EVT048
	2 m orange PVC cable	4 x 0.34 mm ² , Ø 4.9 mm	PVC / stainless steel 316L / 1.4404	250 AC 300 DC	-25...100	IP 65 / IP 67 / IP 68 / IP 69K	-	58	EVT049



Connection technology

Type	Cable	Wire specification	Material housing / nut	U [V]	T _a [°C]	Protection	LEDs	Drawing no.	Order no.
Group 177 · Jumper , plug: M12, 4-pole, socket: M12, 5/4-pole, 4-wire · Wiring diagram no. 3									
	5 m orange PVC cable	4 x 0.34 mm ² , Ø 4.9 mm	PVC / stainless steel 316L / 1.4404	250 AC 300 DC	-25...100	IP 65 / IP 67 / IP 68 / IP 69K	–	58	EVT050
	10 m orange PVC cable	4 x 0.34 mm ² , Ø 4.9 mm	PVC / stainless steel 316L / 1.4404	250 AC 300 DC	-25...100	IP 65 / IP 67 / IP 68 / IP 69K	–	58	EVT051
	0.3 m orange PVC cable	4 x 0.34 mm ² , Ø 4.9 mm	PVC / stainless steel 316L / 1.4404	250 AC 300 DC	-25...100	IP 65 / IP 67 / IP 68 / IP 69K	–	57	EVT040
	0.6 m orange PVC cable	4 x 0.34 mm ² , Ø 4.9 mm	PVC / stainless steel 316L / 1.4404	250 AC 300 DC	-25...100	IP 65 / IP 67 / IP 68 / IP 69K	–	57	EVT041
	1 m orange PVC cable	4 x 0.34 mm ² , Ø 4.9 mm	PVC / stainless steel 316L / 1.4404	250 AC 300 DC	-25...100	IP 65 / IP 67 / IP 68 / IP 69K	–	57	EVT042
	2 m orange PVC cable	4 x 0.34 mm ² , Ø 4.9 mm	PVC / stainless steel 316L / 1.4404	250 AC 300 DC	-25...100	IP 65 / IP 67 / IP 68 / IP 69K	–	57	EVT043
	5 m orange PVC cable	4 x 0.34 mm ² , Ø 4.9 mm	PVC / stainless steel 316L / 1.4404	250 AC 300 DC	-25...100	IP 65 / IP 67 / IP 68 / IP 69K	–	57	EVT044
	10 m orange PVC cable	4 x 0.34 mm ² , Ø 4.9 mm	PVC / stainless steel 316L / 1.4404	PVC / stainless steel 316L / 1.4404	250 AC 300 DC	-25...100	IP 65 / IP 67 / IP 68 / IP 69K	–	57
Group 178 · Jumper , plug: M12, 4-pole, socket: M12, 5/4-pole, 4-wire, LED, PNP · Wiring diagram no. 4									
	0.3 m orange PVC cable	4 x 0.34 mm ² , Ø 4.9 mm	PVC / stainless steel 316L / 1.4404	10...36 DC	-25...100	IP 65 / IP 67 / IP 68 / IP 69K	green / 2 x yellow	59	EVT052
	0.6 m orange PVC cable	4 x 0.34 mm ² , Ø 4.9 mm	PVC / stainless steel 316L / 1.4404	10...36 DC	-25...100	IP 65 / IP 67 / IP 68 / IP 69K	green / 2 x yellow	59	EVT053
	1 m orange PVC cable	4 x 0.34 mm ² , Ø 4.9 mm	PVC / stainless steel 316L / 1.4404	10...36 DC	-25...100	IP 65 / IP 67 / IP 68 / IP 69K	green / 2 x yellow	59	EVT054
	2 m orange PVC cable	4 x 0.34 mm ² , Ø 4.9 mm	PVC / stainless steel 316L / 1.4404	10...36 DC	-25...100	IP 65 / IP 67 / IP 68 / IP 69K	green / 2 x yellow	59	EVT055
	5 m orange PVC cable	4 x 0.34 mm ² , Ø 4.9 mm	PVC / stainless steel 316L / 1.4404	10...36 DC	-25...100	IP 65 / IP 67 / IP 68 / IP 69K	green / 2 x yellow	59	EVT056
	10 m orange PVC cable	4 x 0.34 mm ² , Ø 4.9 mm	PVC / stainless steel 316L / 1.4404	PVC / stainless steel 316L / 1.4404	10...36 DC	-25...100	IP 65 / IP 67 / IP 68 / IP 69K	green / 2 x yellow	59

Type	Cable	Wire specification	Material housing / nut	U [V]	T _a [°C]	Protection	LEDs	Drawing no.	Order no.
------	-------	--------------------	------------------------	-------	---------------------	------------	------	-------------	-----------







Group 179 · Jumper , plug: M12, 5-pole, socket: M12, 5-pole, 5-wire · Wiring diagram no. 5

	0.3 m orange PVC cable	5 x 0.34 mm ² , Ø 5.1 mm	PVC / stainless steel 316L / 1.4404	60 AC 60 DC	-25...100	IP 65 / IP 67 / IP 68 / IP 69K	-	68	EVT058
	0.6 m orange PVC cable	5 x 0.34 mm ² , Ø 5.1 mm	PVC / stainless steel 316L / 1.4404	60 AC 60 DC	-25...100	IP 65 / IP 67 / IP 68 / IP 69K	-	68	EVT059
	1 m orange PVC cable	5 x 0.34 mm ² , Ø 5.1 mm	PVC / stainless steel 316L / 1.4404	60 AC 60 DC	-25...100	IP 65 / IP 67 / IP 68 / IP 69K	-	68	EVT060
	2 m orange PVC cable	5 x 0.34 mm ² , Ø 5.1 mm	PVC / stainless steel 316L / 1.4404	60 AC 60 DC	-25...100	IP 65 / IP 67 / IP 68 / IP 69K	-	68	EVT061
	5 m orange PVC cable	5 x 0.34 mm ² , Ø 5.1 mm	PVC / stainless steel 316L / 1.4404	60 AC 60 DC	-25...100	IP 65 / IP 67 / IP 68 / IP 69K	-	68	EVT062
	10 m orange PVC cable	5 x 0.34 mm ² , Ø 5.1 mm	PVC / stainless steel 316L / 1.4404	60 AC 60 DC	-25...100	IP 65 / IP 67 / IP 68 / IP 69K	-	68	EVT063

Group 180 · Jumper , plug: M12, 4-pole, socket: M12, 5/4-pole, 4-wire · halogen-free · Wiring diagram no. 3

	0.25 m grey MPPE cable	4 x 1.00 mm ² , Ø 6.2 mm	PP / stainless steel 316L / 1.4404	250 AC 300 DC	-25...100	IP 65 / IP 67 / IP 68 / IP 69K	-	57	EVF490
---	------------------------	-------------------------------------	------------------------------------	------------------	-----------	--------------------------------	---	----	---------------















Group 181 · Jumper , plug: M12, 4-pole, socket: M12, 5/4-pole, 4-wire · halogen-free · Wiring diagram no. 8

	0.5 m grey MPPE cable	4 x 1.00 mm ² , Ø 6.2 mm	PP / stainless steel 316L / 1.4404	250 AC 300 DC	-25...100	IP 65 / IP 67 / IP 68 / IP 69K	-	69	EVF491
	1 m grey MPPE cable	4 x 1.00 mm ² , Ø 6.2 mm	PP / stainless steel 316L / 1.4404	250 AC 300 DC	-25...100	IP 65 / IP 67 / IP 68 / IP 69K	-	69	EVF492
	2 m grey MPPE cable	4 x 1.00 mm ² , Ø 6.2 mm	PP / stainless steel 316L / 1.4404	250 AC 300 DC	-25...100	IP 65 / IP 67 / IP 68 / IP 69K	-	69	EVF493
	5 m grey MPPE cable	4 x 1.00 mm ² , Ø 6.2 mm	PP / stainless steel 316L / 1.4404	250 AC 300 DC	-25...100	IP 65 / IP 67 / IP 68 / IP 69K	-	69	EVF494
	10 m grey MPPE cable	4 x 1.00 mm ² , Ø 6.2 mm	PP / stainless steel 316L / 1.4404	250 AC 300 DC	-25...100	IP 65 / IP 67 / IP 68 / IP 69K	-	69	EVF495
	20 m grey MPPE cable	4 x 1.00 mm ² , Ø 6.2 mm	PP / stainless steel 316L / 1.4404	250 AC 300 DC	-25...100	IP 65 / IP 67 / IP 68 / IP 69K	-	69	EVF496



Connection technology

Type	Cable	Wire specification	Material housing / nut	U [V]	T _a [°C]	Protection	LEDs	Drawing no.	Order no.
Group 182 · Jumper , plug: M12, 4-pole, socket: M12, 5/4-pole, 4-wire · halogen-free · Wiring diagram no. 3									
	0.25 m grey MPPE cable	4 x 1.00 mm ² , Ø 6.2 mm	PP / stainless steel 316L / 1.4404	250 AC 300 DC	-25...100	IP 65 / IP 67 / IP 68 / IP 69K	–	58	EVF497
	0.5 m grey MPPE cable	4 x 1.00 mm ² , Ø 6.2 mm	PP / stainless steel 316L / 1.4404	250 AC 300 DC	-25...100	IP 65 / IP 67 / IP 68 / IP 69K	–	58	EVF498
	1 m grey MPPE cable	4 x 1.00 mm ² , Ø 6.2 mm	PP / stainless steel 316L / 1.4404	250 AC 300 DC	-25...100	IP 65 / IP 67 / IP 68 / IP 69K	–	58	EVF499
	2 m grey MPPE cable	4 x 1.00 mm ² , Ø 6.2 mm	PP / stainless steel 316L / 1.4404	250 AC 300 DC	-25...100	IP 65 / IP 67 / IP 68 / IP 69K	–	58	EVF500
	5 m grey MPPE cable	4 x 1.00 mm ² , Ø 6.2 mm	PP / stainless steel 316L / 1.4404	250 AC 300 DC	-25...100	IP 65 / IP 67 / IP 68 / IP 69K	–	58	EVF501
	10 m grey MPPE cable	4 x 1.00 mm ² , Ø 6.2 mm	PP / stainless steel 316L / 1.4404	250 AC 300 DC	-25...100	IP 65 / IP 67 / IP 68 / IP 69K	–	58	EVF502
	20 m grey MPPE cable	4 x 1.00 mm ² , Ø 6.2 mm	PP / stainless steel 316L / 1.4404	250 AC 300 DC	-25...100	IP 65 / IP 67 / IP 68 / IP 69K	–	58	EVF503
	0.25 m grey MPPE cable	4 x 1.00 mm ² , Ø 6.2 mm	PP / stainless steel 316L / 1.4404	250 AC 300 DC	-25...100	IP 65 / IP 67 / IP 68 / IP 69K	–	70	EVF504
	0.5 m grey MPPE cable	4 x 1.00 mm ² , Ø 6.2 mm	PP / stainless steel 316L / 1.4404	250 AC 300 DC	-25...100	IP 65 / IP 67 / IP 68 / IP 69K	–	70	EVF505
	1 m grey MPPE cable	4 x 1.00 mm ² , Ø 6.2 mm	PP / stainless steel 316L / 1.4404	250 AC 300 DC	-25...100	IP 65 / IP 67 / IP 68 / IP 69K	–	70	EVF506
	2 m grey MPPE cable	4 x 1.00 mm ² , Ø 6.2 mm	PP / stainless steel 316L / 1.4404	250 AC 300 DC	-25...100	IP 65 / IP 67 / IP 68 / IP 69K	–	70	EVF507
	5 m grey MPPE cable	4 x 1.00 mm ² , Ø 6.2 mm	PP / stainless steel 316L / 1.4404	250 AC 300 DC	-25...100	IP 65 / IP 67 / IP 68 / IP 69K	–	70	EVF508
	10 m grey MPPE cable	4 x 1.00 mm ² , Ø 6.2 mm	PP / stainless steel 316L / 1.4404	250 AC 300 DC	-25...100	IP 65 / IP 67 / IP 68 / IP 69K	–	70	EVF509
	20 m grey MPPE cable	4 x 1.00 mm ² , Ø 6.2 mm	PP / stainless steel 316L / 1.4404	250 AC 300 DC	-25...100	IP 65 / IP 67 / IP 68 / IP 69K	–	70	EVF510

Type	Cable	Wire specification	Material housing / nut	U [V]	T _a [°C]	Protection	LEDs	Drawing no.	Order no.
Group 182 · Jumper , plug: M12, 4-pole, socket: M12, 5/4-pole, 4-wire · halogen-free · Wiring diagram no. 3									
	0.25 m grey MPPE cable	4 x 1.00 mm ² , Ø 6.2 mm	PP / stainless steel 316L / 1.4404	250 AC 300 DC	-25...100	IP 65 / IP 67 / IP 68 / IP 69K	-	71	EVF511
	0.5 m grey MPPE cable	4 x 1.00 mm ² , Ø 6.2 mm	PP / stainless steel 316L / 1.4404	250 AC 300 DC	-25...100	IP 65 / IP 67 / IP 68 / IP 69K	-	71	EVF512
	1 m grey MPPE cable	4 x 1.00 mm ² , Ø 6.2 mm	PP / stainless steel 316L / 1.4404	250 AC 300 DC	-25...100	IP 65 / IP 67 / IP 68 / IP 69K	-	71	EVF513
	2 m grey MPPE cable	4 x 1.00 mm ² , Ø 6.2 mm	PP / stainless steel 316L / 1.4404	250 AC 300 DC	-25...100	IP 65 / IP 67 / IP 68 / IP 69K	-	71	EVF514
	5 m grey MPPE cable	4 x 1.00 mm ² , Ø 6.2 mm	PP / stainless steel 316L / 1.4404	250 AC 300 DC	-25...100	IP 65 / IP 67 / IP 68 / IP 69K	-	71	EVF515
	10 m grey MPPE cable	4 x 1.00 mm ² , Ø 6.2 mm	PP / stainless steel 316L / 1.4404	250 AC 300 DC	-25...100	IP 65 / IP 67 / IP 68 / IP 69K	-	71	EVF516
	20 m grey MPPE cable	4 x 1.00 mm ² , Ø 6.2 mm	PP / stainless steel 316L / 1.4404	250 AC 300 DC	-25...100	IP 65 / IP 67 / IP 68 / IP 69K	-	71	EVF517
Group 183 · Jumper , plug: M12, 4-pole, 4-wire · halogen-free · Wiring diagram no. 9									
	0.25 m grey MPPE cable	4 x 0.34 mm ² , Ø 6.5 mm	PP / stainless steel 316L / 1.4404	50 AC 60 DC	-25...80	IP 65 / IP 67 / IP 68 / IP 69K	-	72	EVF528
	0.5 m grey MPPE cable	4 x 0.34 mm ² , Ø 6.5 mm	PP / stainless steel 316L / 1.4404	50 AC 60 DC	-25...80	IP 65 / IP 67 / IP 68 / IP 69K	-	72	EVF529
	1 m grey MPPE cable	4 x 0.34 mm ² , Ø 6.5 mm	PP / stainless steel 316L / 1.4404	50 AC 60 DC	-25...80	IP 65 / IP 67 / IP 68 / IP 69K	-	72	EVF530
	2 m grey MPPE cable	4 x 0.34 mm ² , Ø 6.5 mm	PP / stainless steel 316L / 1.4404	50 AC 60 DC	-25...80	IP 65 / IP 67 / IP 68 / IP 69K	-	72	EVF531
	5 m grey MPPE cable	4 x 0.34 mm ² , Ø 6.5 mm	PP / stainless steel 316L / 1.4404	50 AC 60 DC	-25...80	IP 65 / IP 67 / IP 68 / IP 69K	-	72	EVF532
	10 m grey MPPE cable	4 x 0.34 mm ² , Ø 6.5 mm	PP / stainless steel 316L / 1.4404	50 AC 60 DC	-25...80	IP 65 / IP 67 / IP 68 / IP 69K	-	72	EVF533
	20 m grey MPPE cable	4 x 0.34 mm ² , Ø 6.5 mm	PP / stainless steel 316L / 1.4404	50 AC 60 DC	-25...80	IP 65 / IP 67 / IP 68 / IP 69K	-	72	EVF534



Connection technology

Jumpers for hazardous areas

Type	Cable	Wire specification	Material housing / nut	U [V]	T _a [°C]	Protection	LEDs	Drawing no.	Order no.
Group 198 · Jumper, plug: M12, 4-pole, socket: M12, 5/4-pole, 4-wire · Wiring diagram no. 3									
	0.3 m black PUR cable	4 x 0.34 mm ² , Ø 4.9 mm	TPU / stainless steel 316L / 1.4404	60 AC 60 DC	-20...60	IP 67	–	73	EVC09A
	0.6 m black PUR cable	4 x 0.34 mm ² , Ø 4.9 mm	TPU / stainless steel 316L / 1.4404	60 AC 60 DC	-20...60	IP 67	–	73	EVC10A
	1 m black PUR cable	4 x 0.34 mm ² , Ø 4.9 mm	TPU / stainless steel 316L / 1.4404	60 AC 60 DC	-20...60	IP 67	–	73	EVC11A
	2 m black PUR cable	4 x 0.34 mm ² , Ø 4.9 mm	TPU / stainless steel 316L / 1.4404	60 AC 60 DC	-20...60	IP 67	–	73	EVC07A
	5 m black PUR cable	4 x 0.34 mm ² , Ø 4.9 mm	TPU / stainless steel 316L / 1.4404	60 AC 60 DC	-20...60	IP 67	–	73	EVC12A
	10 m black PUR cable	4 x 0.34 mm ² , Ø 4.9 mm	TPU / stainless steel 316L / 1.4404	60 AC 60 DC	-20...60	IP 67	–	73	EVC13A

Wiring diagrams

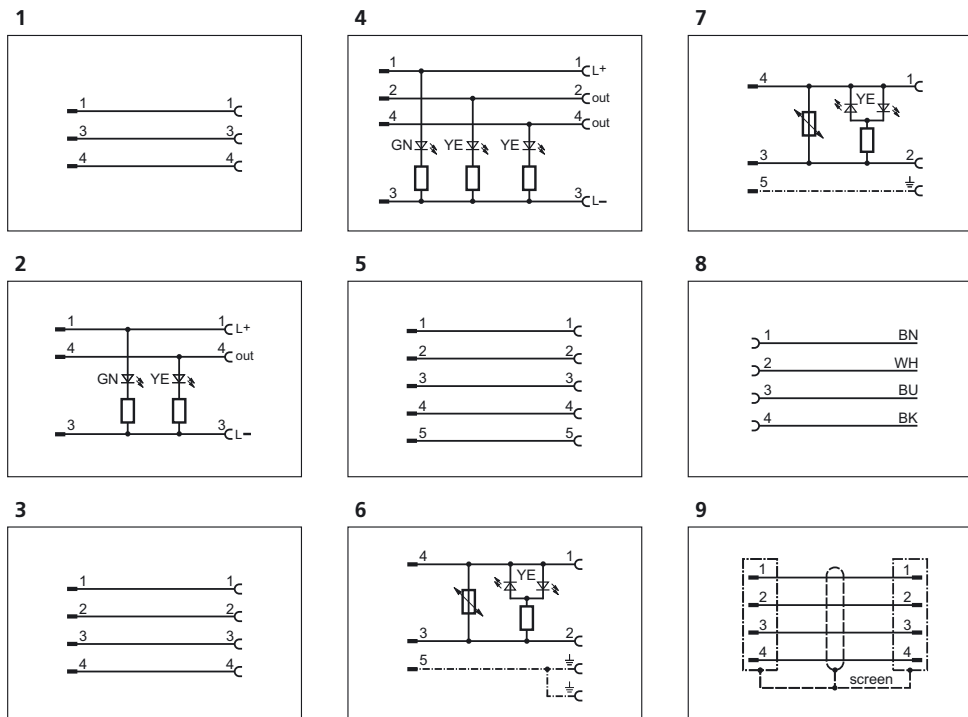

Scale drawings / drawing no. – CAD download: www.ifm.com

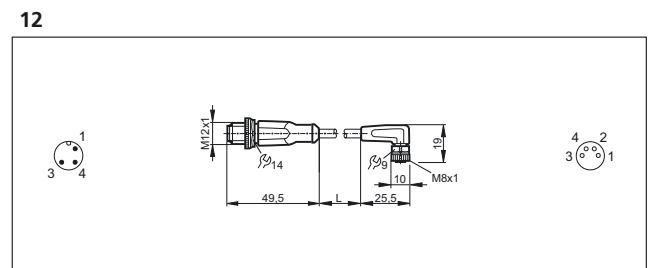
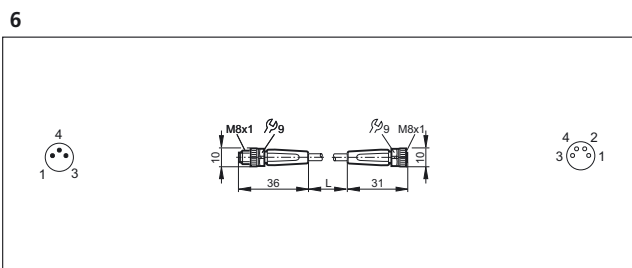
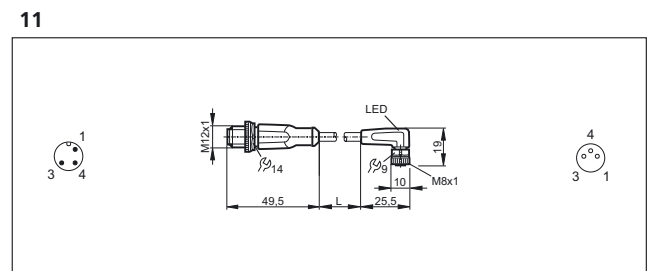
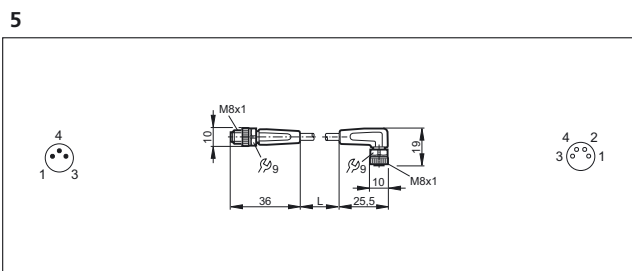
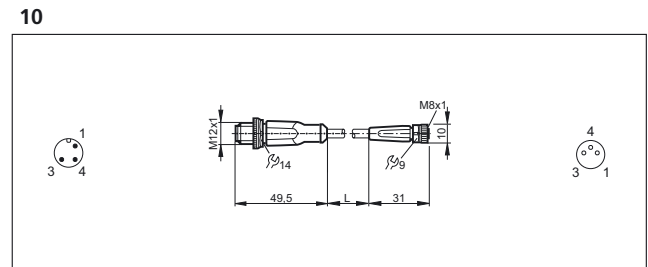
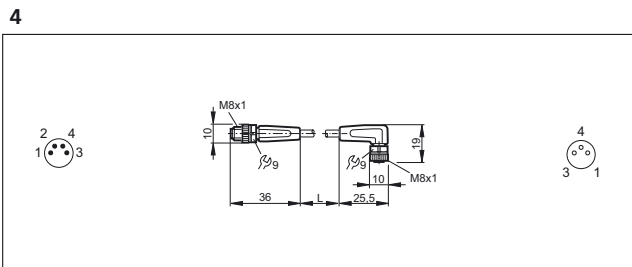
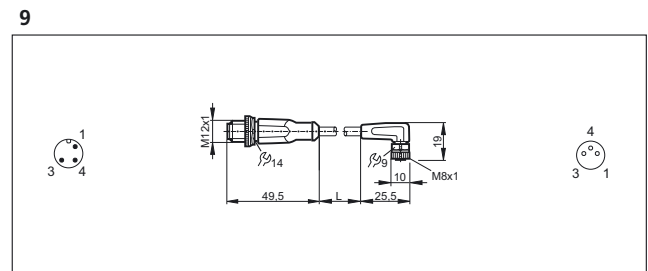
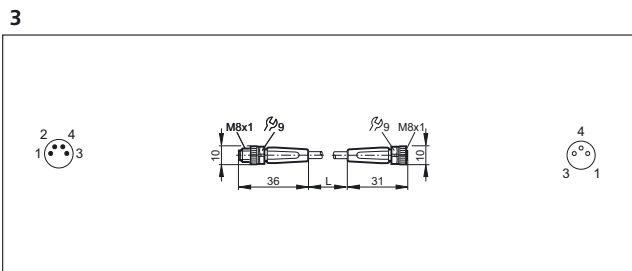
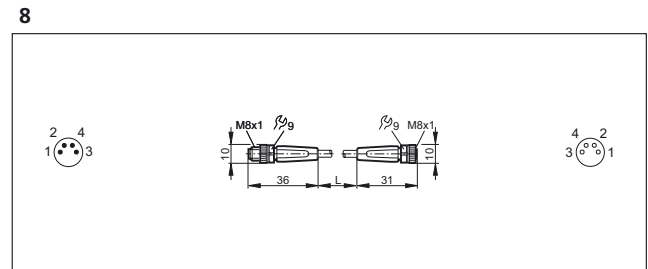
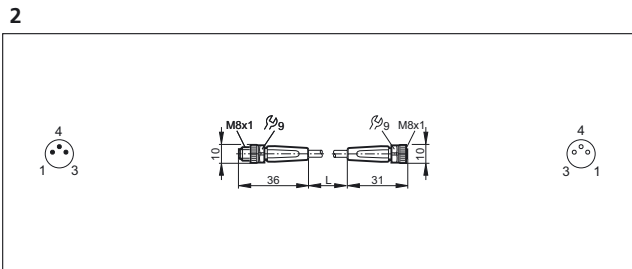
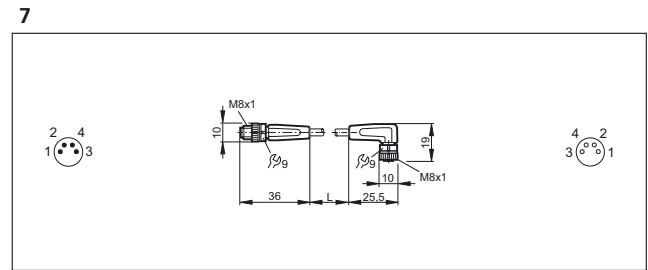
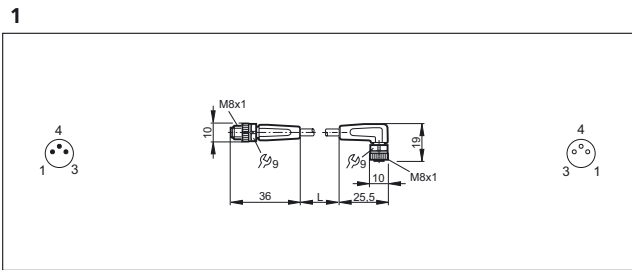



Scale drawings / drawing no. – CAD download: www.ifm.com

13

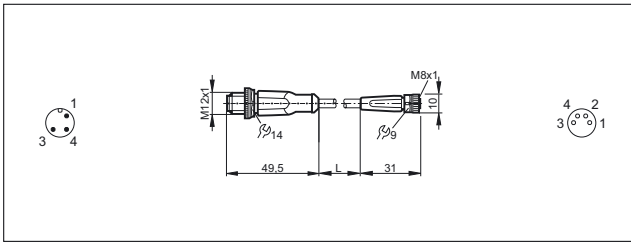

19

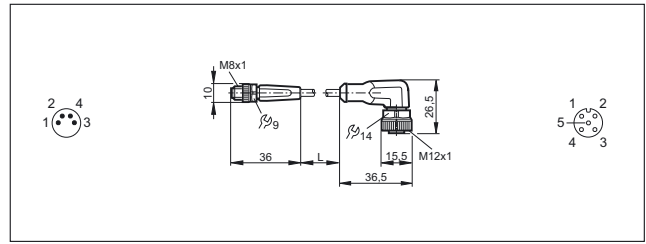

14

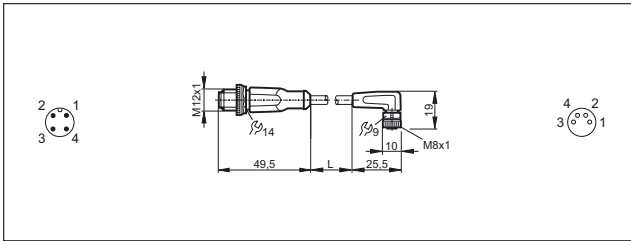

20

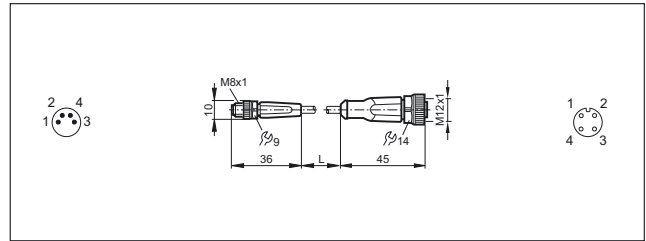

15

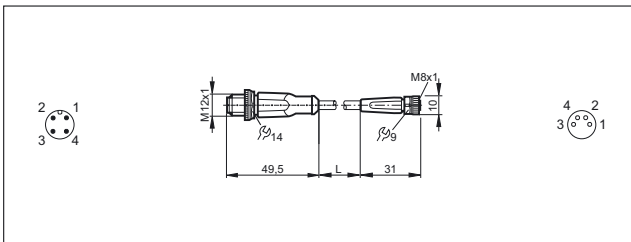

21

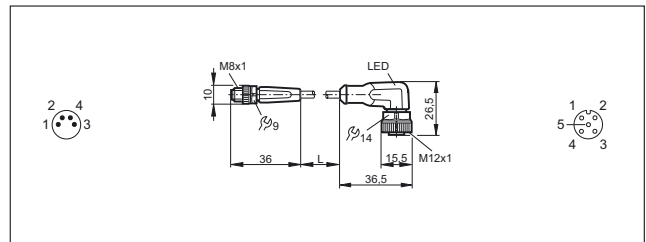

16

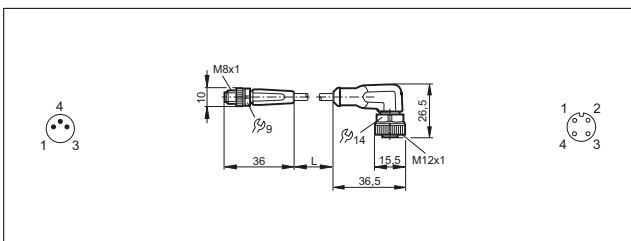

22

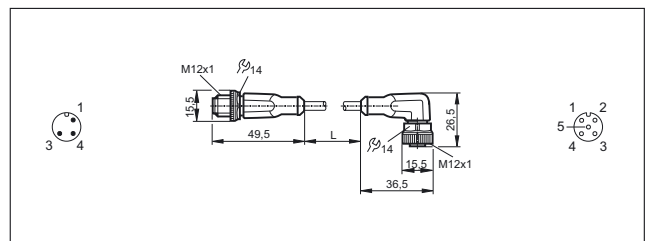

17

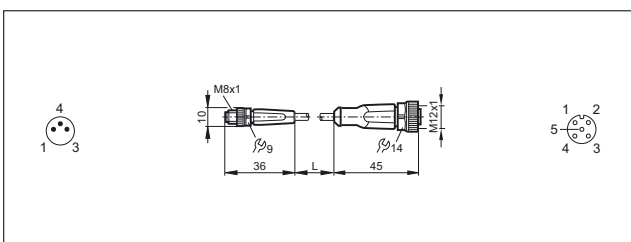

23

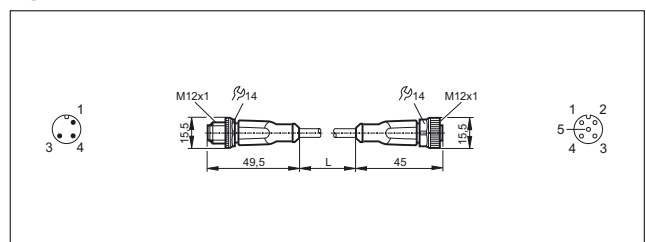

18

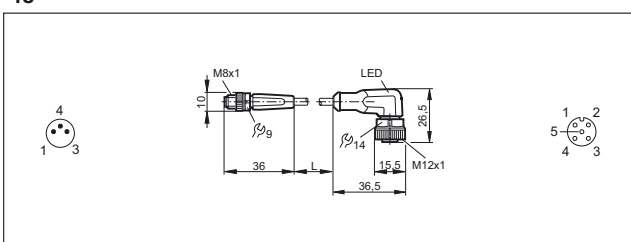

24

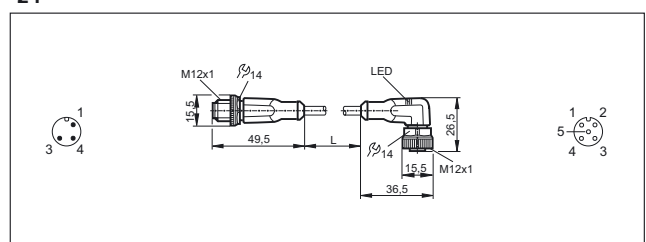

Scale drawings / drawing no. – CAD download: www.ifm.com

25

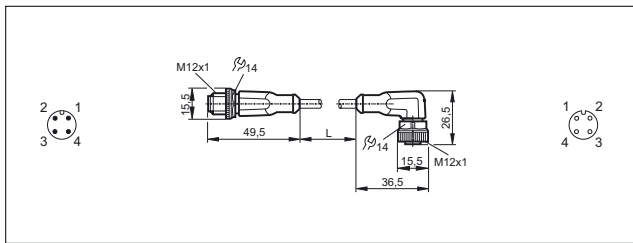

31

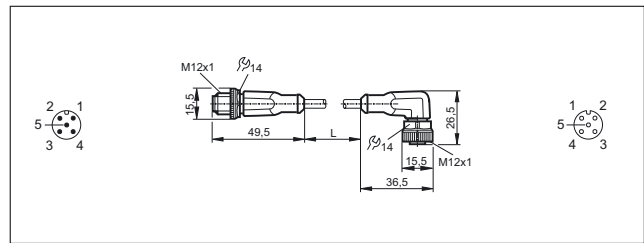

26

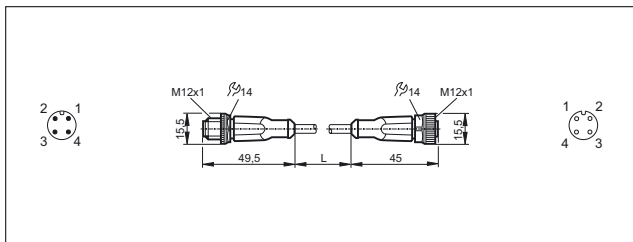

32

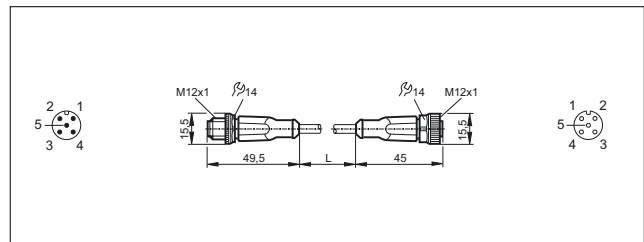

27

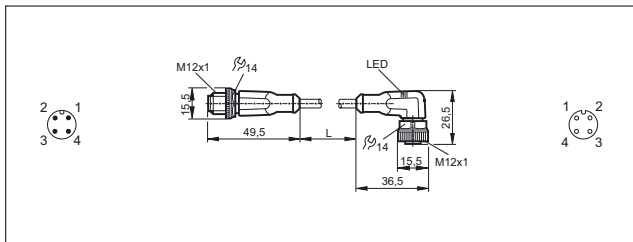

33

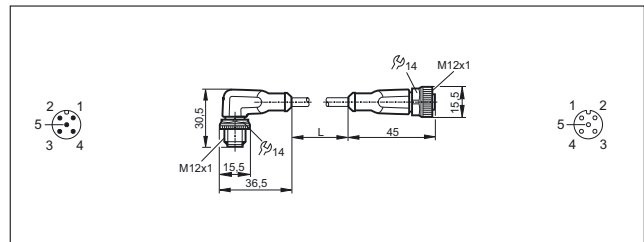

28

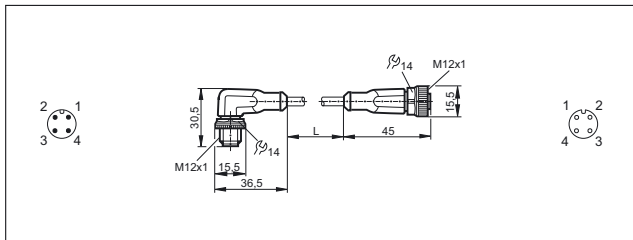

34

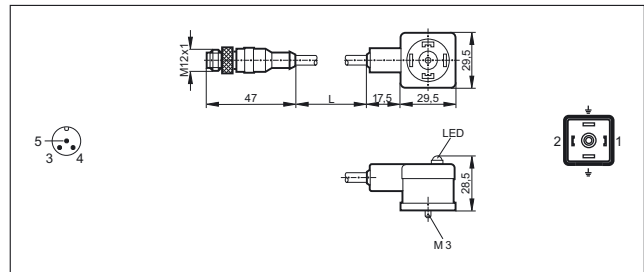

29

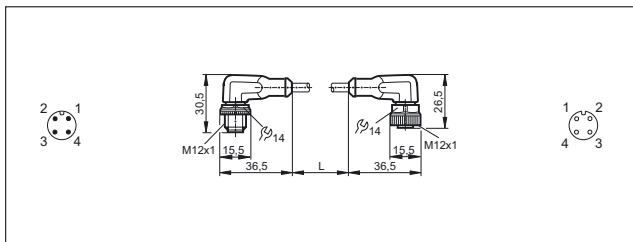

35

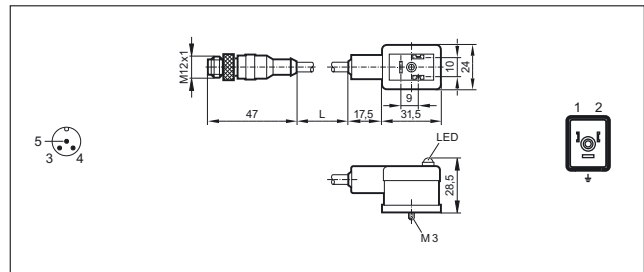

30

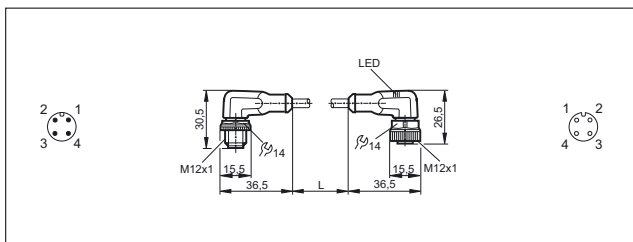

36

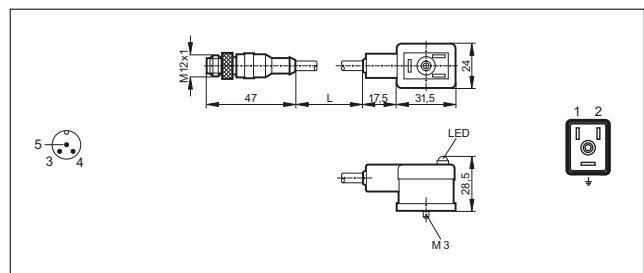



Scale drawings / drawing no. – CAD download: www.ifm.com

37

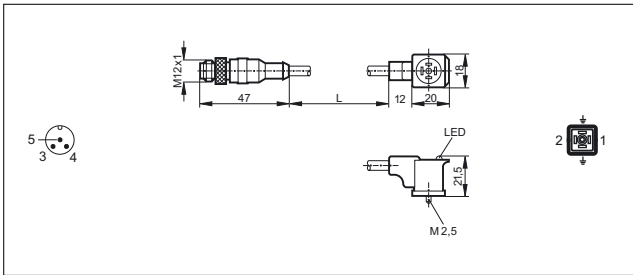

43

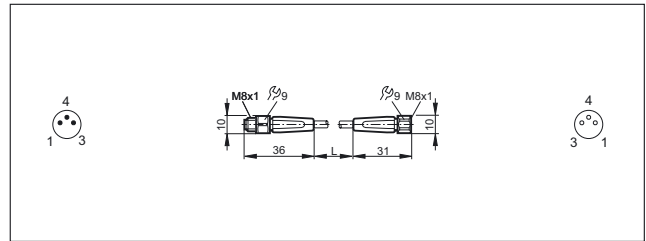

38

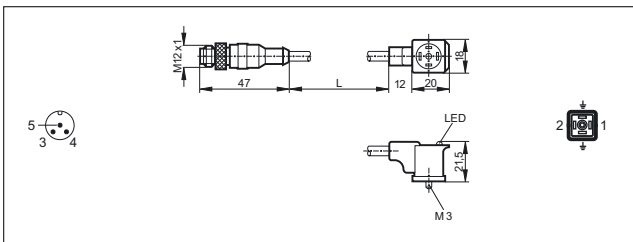

44

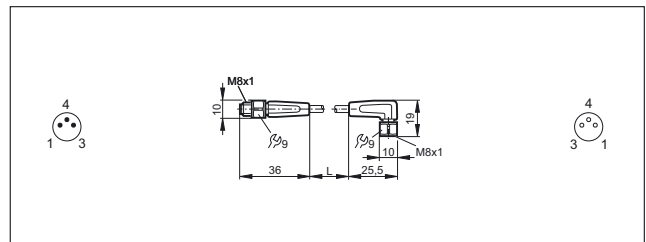

39

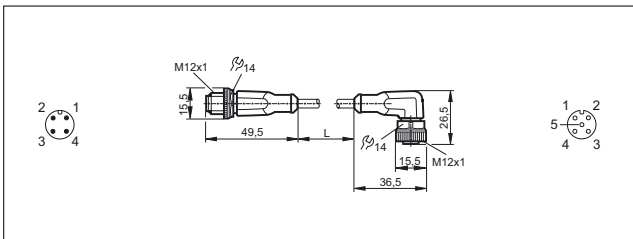

45

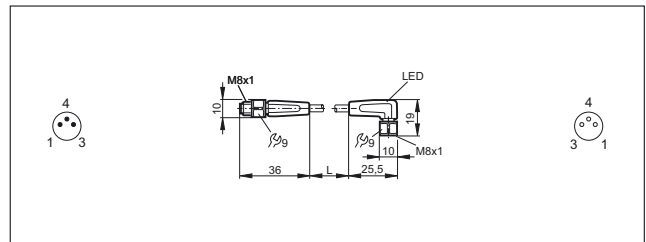

40

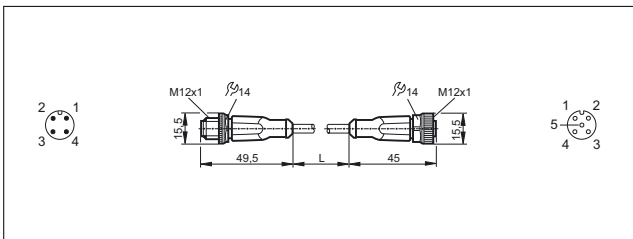

46

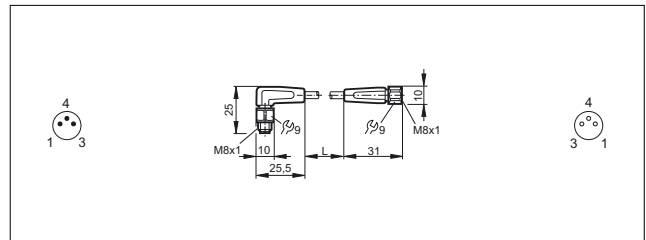

41

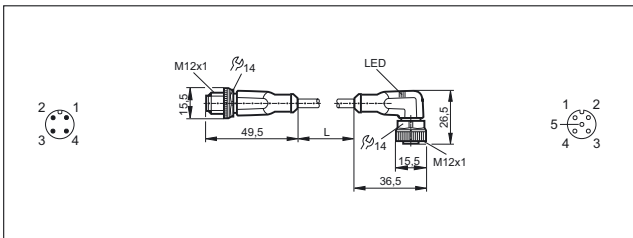

47

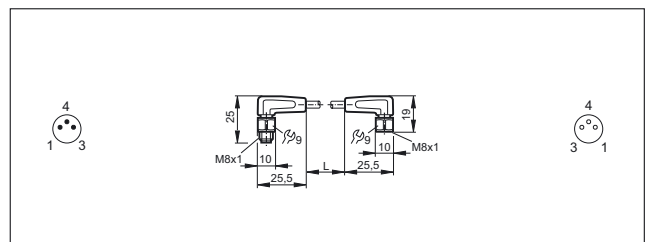

42

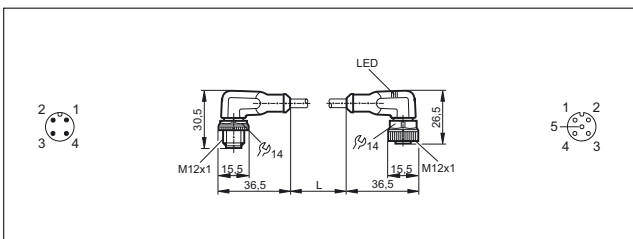

48

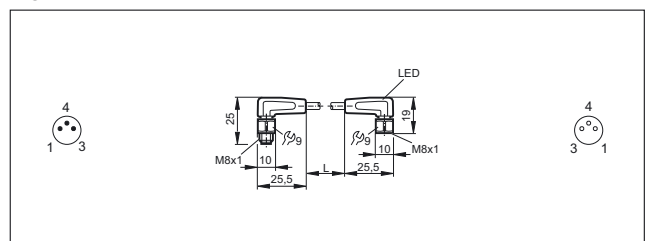

Scale drawings / drawing no. – CAD download: www.ifm.com

49

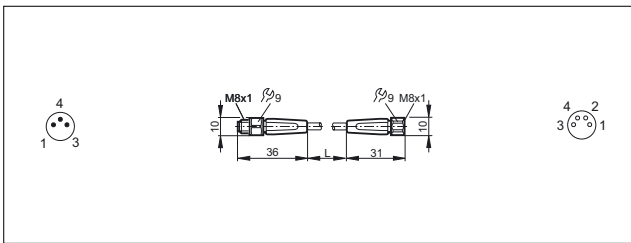

55

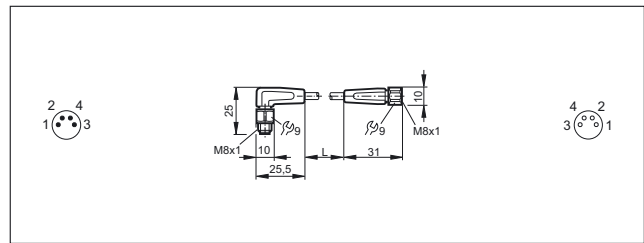

50

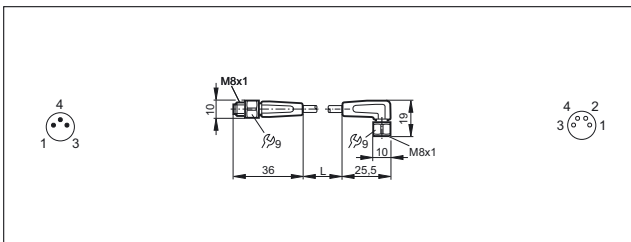

56

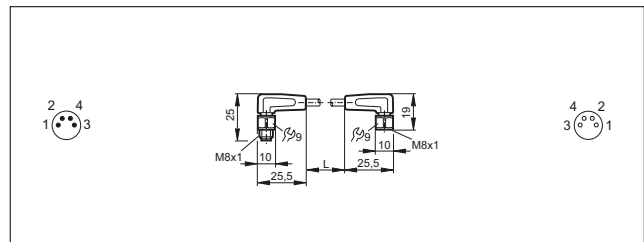

51

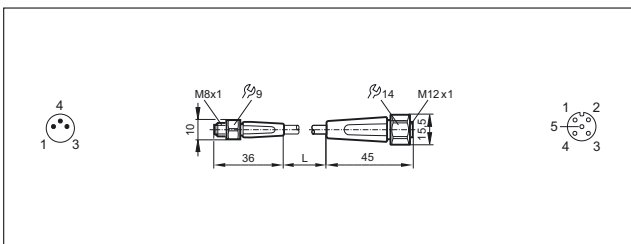

57

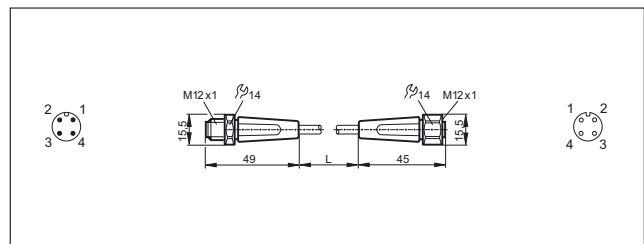

52

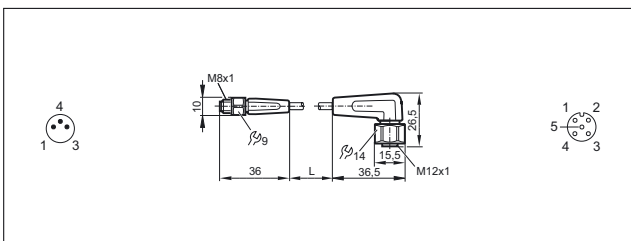

58

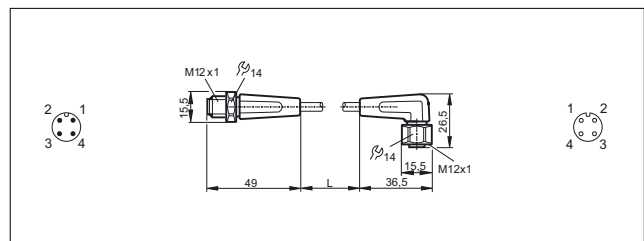

53

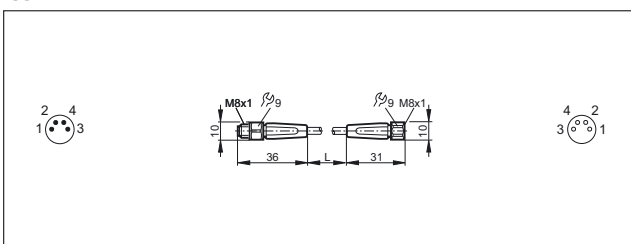

59

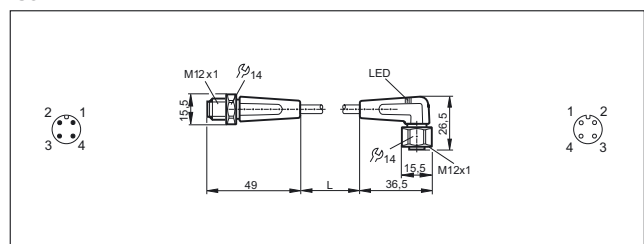

54

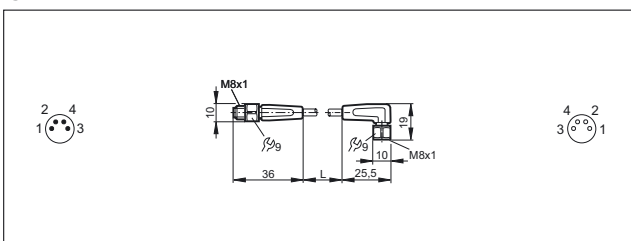

60

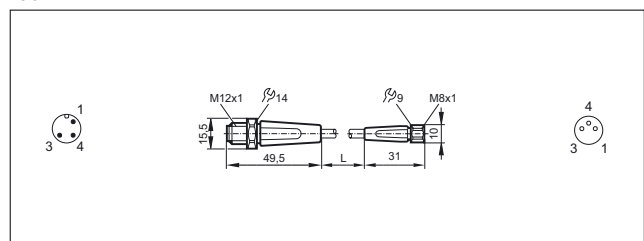



Connection technology

Scale drawings / drawing no. – CAD download: www.ifm.com

61

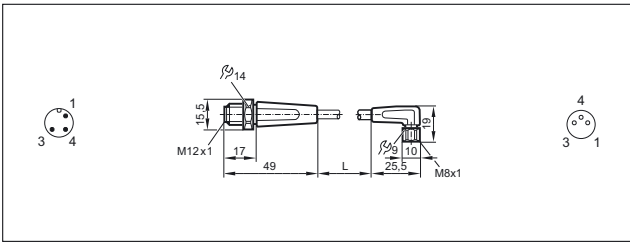

67

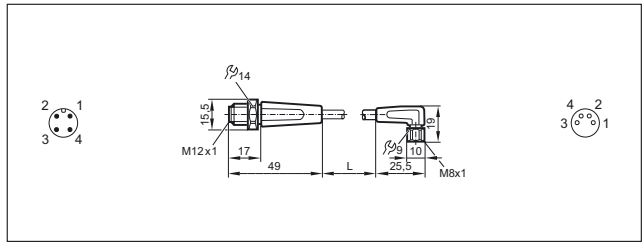

62

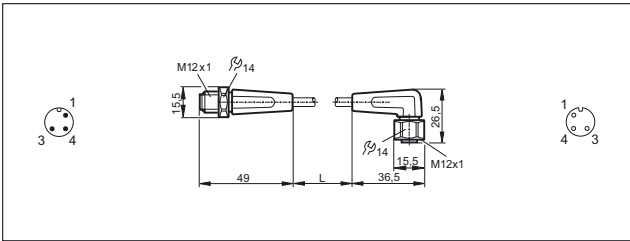

68

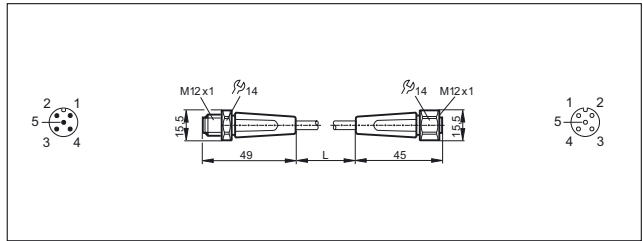

63

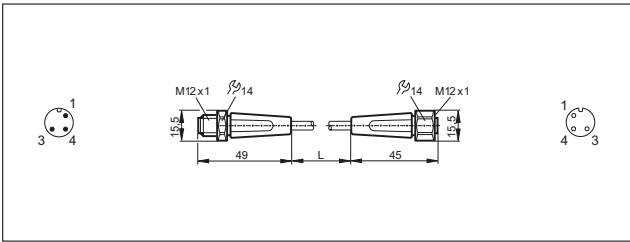

69

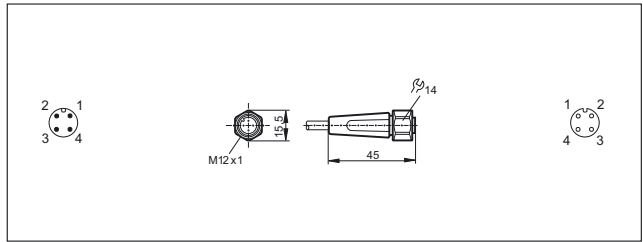

64

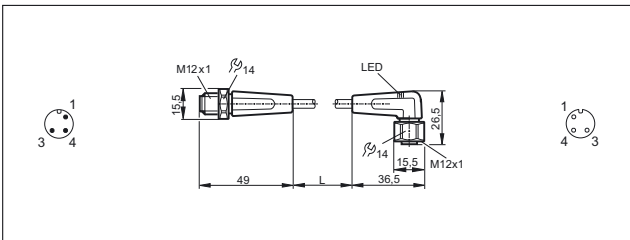

70

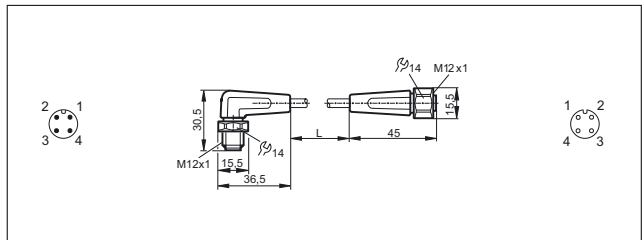

65

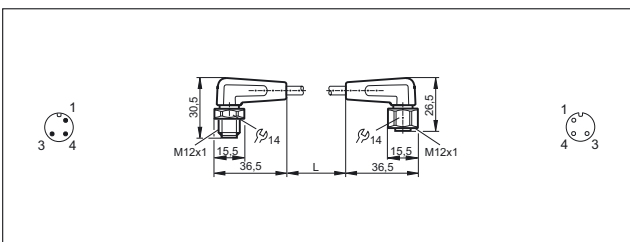

71

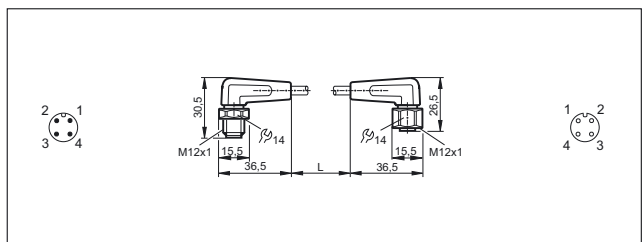

66

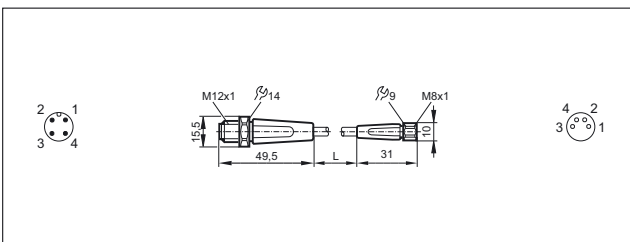

72

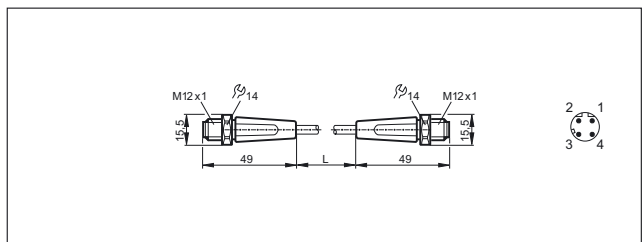

Scale drawings / drawing no. – CAD download: www.ifm.com

73

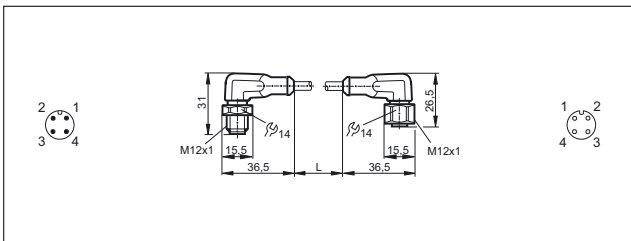



Connection technology



Splitter boxes



Splitter boxes enable the connection of several sensors and the transmission of the corresponding signals and supply voltages via a multi-wire cable.

This considerably reduces installation and wiring complexity.

In addition to splitter boxes with potted cable, versions with central connector are also available.

System overview	Page
Splitter boxes for industrial applications	836 - 843
Splitter boxes for hygienic and wet areas	843 - 844
Wiring diagrams	844 - 850
Scale drawings / drawing no. – CAD download: www.ifm.com	850 - 855

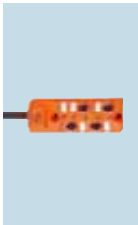
Splitter boxes for industrial applications







Type	Cable	Wire specification	Material housing / nut	U [V]	T _a [°C]	Protection	LEDs	Drawing no.	Order no.
Group 76 · M12 splitter box for 1 signal · Wiring diagram no. 1									
	5 m black PUR cable	4 x 0.25 mm ² , Ø 5 mm	TPU / Brass	10...55 DC	-25...80	IP 67	–	1	E10437
Group 77 · splitter box M8, 3-pole, LED · Wiring diagram no. 20									
	5 m black PUR cable	4 x 0.34 mm ² + 2 x 0.75 mm ² , Ø 6.4 mm	PBT-GF 20	10...30 DC	-25...80	IP 65 / IP 67 / IP 68	green / 4 x yellow	2	EBC048
	10 m black PUR cable	4 x 0.34 mm ² + 2 x 0.75 mm ² , Ø 6.4 mm	PBT-GF 20	10...30 DC	-25...80	IP 65 / IP 67 / IP 68	green / 4 x yellow	2	EBC049
Group 78 · splitter box M8, 3-pole, LED · Wiring diagram no. 21									
	M12 connector	–	PBT-GF 20	10...30 DC	-25...80	IP 67 / IP 68	green / 4 x yellow	3	EBC050
Group 79 · splitter box M8, 4-pole, LED · Wiring diagram no. 22									
	5 m black PUR cable	8 x 0.34 mm ² + 2 x 0.75 mm ² , Ø 7.4 mm	PBT-GF 20	10...30 DC	-25...80	IP 65 / IP 67 / IP 68	green / 8 x yellow	4	EBC051
	10 m black PUR cable	8 x 0.34 mm ² + 2 x 0.75 mm ² , Ø 7.4 mm	PBT-GF 20	10...30 DC	-25...80	IP 65 / IP 67 / IP 68	green / 8 x yellow	4	EBC052

Type	Cable	Wire specification	Material housing / nut	U [V]	T _a [°C]	Protection	LEDs	Drawing no.	Order no.
Group 80 · splitter box M8, 4-pole, LED · Wiring diagram no. 23									
	M16 connector	–	PBT-GF 20	10...30 DC	-25...80	IP 67 / IP 68	green / 8 x yellow	5	EBC053
Group 81 · splitter box M8, 3-pole, LED · Wiring diagram no. 24									
	5 m black PUR cable	8 x 0.34 mm ² + 2 x 0.75 mm ² , Ø 7.4 mm	PBT-GF 20	10...30 DC	-25...80	IP 65 / IP 67 / IP 68	green / 8 x yellow	6	EBC054
	10 m black PUR cable	8 x 0.34 mm ² + 2 x 0.75 mm ² , Ø 9.1 mm	PBT-GF 20	10...30 DC	-25...80	IP 65 / IP 67 / IP 68	green / 8 x yellow	6	EBC055
Group 82 · splitter box M8, 4-pole, LED · Wiring diagram no. 25									
	5 m black PUR cable	16 x 0.34 mm ² + 2 x 0.75 mm ² , Ø 8.5 mm	PBT-GF 20	10...30 DC	-25...80	IP 65 / IP 67 / IP 68	green / 16 x yellow	7	EBC056
	10 m black PUR cable	16 x 0.34 mm ² + 2 x 0.75 mm ² , Ø 8.5 mm	PBT-GF 20	10...30 DC	-25...80	IP 65 / IP 67 / IP 68	green / 16 x yellow	7	EBC057
Group 83 · splitter box M8, 3-pole, LED · Wiring diagram no. 26									
	5 m black PUR cable	4 x 0.34 mm ² + 2 x 0.75 mm ² , Ø 6.4 mm	PBT-GF 20	10...30 DC	-25...80	IP 65 / IP 67 / IP 68	green / 4 x yellow	2	EBC058
	10 m black PUR cable	4 x 0.34 mm ² + 2 x 0.75 mm ² , Ø 6.4 mm	PBT-GF 20	10...30 DC	-25...80	IP 65 / IP 67 / IP 68	green / 4 x yellow	2	EBC059
Group 84 · splitter box M8, 3-pole, LED · Wiring diagram no. 27									
	M12 connector	–	PBT-GF 20	10...30 DC	-25...80	IP 65 / IP 67 / IP 68	green / 4 x yellow	3	EBC060
Group 85 · splitter box M8, 4-pole, LED · Wiring diagram no. 28									
	5 m black PUR cable	8 x 0.34 mm ² + 2 x 0.75 mm ² , Ø 7.4 mm	PBT-GF 20	10...30 DC	-20...80	IP 65 / IP 67 / IP 68	green / 8 x yellow	4	EBC061
	10 m black PUR cable	8 x 0.34 mm ² + 2 x 0.75 mm ² , Ø 7.4 mm	PBT-GF 20	10...30 DC	-20...80	IP 65 / IP 67 / IP 68	green / 8 x yellow	4	EBC062
Group 86 · splitter box M8, 4-pole, LED · Wiring diagram no. 29									
	M16 connector	–	PBT-GF 20	10...30 DC	-25...80	IP 67 / IP 68	green / 8 x yellow	5	EBC063

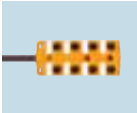
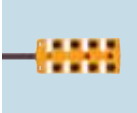

Connection technology

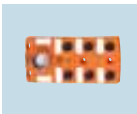







Type	Cable	Wire specification	Material housing / nut	U [V]	T _a [°C]	Protection	LEDs	Drawing no.	Order no.
Group 87 · splitter box M8, 3-pole, LED · Wiring diagram no. 30									
	5 m black PUR cable	8 x 0.34 mm ² + 2 x 0.75 mm ² , Ø 9.1 mm	PBT-GF 20	10...30 DC	-25...80	IP 65 / IP 67 / IP 68	green / 8 x yellow	6	EBC064
	10 m black PUR cable	8 x 0.34 mm ² + 2 x 0.75 mm ² , Ø 9.1 mm	PBT-GF 20	10...30 DC	-25...80	IP 65 / IP 67 / IP 68	green / 8 x yellow	6	EBC065
Group 88 · splitter box M8, 4-pole, LED · Wiring diagram no. 31									
	5 m black PUR cable	16 x 0.34 mm ² + 2 x 0.75 mm ² , Ø 8.5 mm	PBT-GF 20	10...30 DC	-20...80	IP 65 / IP 67 / IP 68	green / 16 x yellow	7	EBC066
	10 m black PUR cable	16 x 0.34 mm ² + 2 x 0.75 mm ² , Ø 8.5 mm	PBT-GF 20	10...30 DC	-20...80	IP 65 / IP 67 / IP 68	green / 16 x yellow	7	EBC067
Group 89 · M12 splitter box for 1 signal · Wiring diagram no. 2									
	5 m black PUR cable	4 x 0.34 mm ² + 3 x 1 mm ² , Ø 7.5 mm	PA	30 AC/DC	-25...80	IP 67 / IP 68	–	8	EBC013
	10 m black PUR cable	4 x 0.34 mm ² + 3 x 1 mm ² , Ø 7.5 mm	PA	30 AC/DC	-25...80	IP 67 / IP 68	–	8	EBC025
Group 90 · M12 splitter box for 1 signal, LED · Wiring diagram no. 32									
	5 m black PUR cable	4 x 0.34 mm ² + 3 x 1 mm ² , Ø 7.5 mm	PA	10...30 DC	-25...80	IP 67 / IP 68	green / 4 x yellow	9	EBC015
	10 m black PUR cable	4 x 0.34 mm ² + 3 x 1 mm ² , Ø 7.5 mm	PA	10...30 DC	-25...80	IP 67 / IP 68	green / 4 x yellow	9	EBC027
Group 91 · M12 splitter box for 1 signal · Wiring diagram no. 3									
	5 m black PUR cable	6 x 0.34 mm ² + 3 x 1 mm ² , Ø 7.8 mm	PA	30 AC/DC	-25...80	IP 67 / IP 68	–	10	EBC017
	10 m black PUR cable	6 x 0.34 mm ² + 3 x 1 mm ² , Ø 7.8 mm	PA	30 AC/DC	-25...80	IP 67 / IP 68	–	10	EBC029
Group 92 · M12 splitter box for 1 signal, LED · Wiring diagram no. 33									
	5 m black PUR cable	6 x 0.34 mm ² + 3 x 1 mm ² , Ø 7.8 mm	PA	10...30 DC	-25...80	IP 67 / IP 68	green / 6 x yellow	11	EBC019
	10 m black PUR cable	6 x 0.34 mm ² + 3 x 1 mm ² , Ø 7.8 mm	PA	10...30 DC	-25...80	IP 67 / IP 68	green / 6 x yellow	11	EBC031

Type	Cable	Wire specification	Material housing / nut	U [V]	T _a [°C]	Protection	LEDs	Drawing no.	Order no.
Group 93 · M12 splitter box for 1 signal · Wiring diagram no. 4									
	5 m black PUR cable	8 x 0.34 mm ² + 3 x 0.75 mm ² , Ø 8.2 mm	PA	30 AC/DC	-25...80	IP 67 / IP 68	–	12	EBC021
	10 m black PUR cable	8 x 0.34 mm ² + 3 x 0.75 mm ² , Ø 8.2 mm	PA	30 AC/DC	-25...80	IP 67 / IP 68	–	12	EBC033
Group 94 · M12 splitter box for 1 signal, LED · Wiring diagram no. 34									
	5 m black PUR cable	8 x 0.34 mm ² + 3 x 0.75 mm ² , Ø 8.2 mm	PA	10...30 DC	-25...80	IP 67 / IP 68	green / 8 x yellow	13	EBC023
	10 m black PUR cable	8 x 0.34 mm ² + 3 x 0.75 mm ² , Ø 8.2 mm	PA	10...30 DC	-25...80	IP 67 / IP 68	green / 8 x yellow	13	EBC035
Group 95 · M12 splitter box for 1 signal · Wiring diagram no. 5									
	M23 connector	–	PA	30 AC/DC	-25...80	IP 67	–	14	EBC001
Group 96 · M12 splitter box for 1 signal, LED · Wiring diagram no. 35									
	M23 connector	–	PA	10...30 DC	-25...80	IP 67	green / 4 x yellow	15	EBC002
Group 97 · M12 splitter box for 1 signal · Wiring diagram no. 6									
	M23 connector	–	PA	30 AC/DC	-25...80	IP 67	–	16	EBC005
Group 98 · M12 splitter box for 1 signal, LED · Wiring diagram no. 36									
	M23 connector	–	PA	10...30 DC	-25...80	IP 67	green / 6 x yellow	17	EBC006
Group 99 · M12 splitter box for 1 signal · Wiring diagram no. 7									
	M23 connector	–	PA	30 AC/DC	-25...80	IP 67	–	18	EBC009
Group 100 · M12 splitter box for 1 signal, LED · Wiring diagram no. 37									
	M23 connector	–	PA	10...30 DC	-25...80	IP 67	green / 8 x yellow	19	EBC010



Connection technology

Type	Cable	Wire specification	Material housing / nut	U [V]	T _a [°C]	Protection	LEDs	Drawing no.	Order no.
Group 101 · M12 splitter box for 2 signals · Wiring diagram no. 8									
	5 m black PUR cable	8 x 0.34 mm ² + 3 x 1.0 mm ² , Ø 8.2 mm	PA	30 AC/DC	-25...80	IP 67 / IP 68	–	8	EBC014
	10 m black PUR cable	8 x 0.34 mm ² + 3 x 1.0 mm ² , Ø 8.2 mm	PA	30 AC/DC	-25...80	IP 67 / IP 68	–	8	EBC026
Group 102 · M12 splitter box for 2 signals, LED · Wiring diagram no. 38									
	5 m black PUR cable	8 x 0.34 mm ² + 3 x 1.0 mm ² , Ø 8.2 mm	PA	10...30 DC	-25...80	IP 67 / IP 68	green / 8 x yellow	20	EBC016
	10 m black PUR cable	8 x 0.34 mm ² + 3 x 1.0 mm ² , Ø 8.2 mm	PA	10...30 DC	-25...80	IP 67 / IP 68	green / 8 x yellow	20	EBC028
Group 103 · M12 splitter box for 2 signals · Wiring diagram no. 39									
	5 m black PUR cable	12 x 0.34 mm ² + 3 x 1.0 mm ² , Ø 8.8 mm	PA	30 AC/DC	-25...80	IP 67 / IP 68	–	10	EBC018
	10 m black PUR cable	12 x 0.34 mm ² + 3 x 1.0 mm ² , Ø 8.8 mm	PA	30 AC/DC	-25...80	IP 67 / IP 68	–	10	EBC030
Group 104 · M12 splitter box for 2 signals, LED · Wiring diagram no. 40									
	5 m black PUR cable	12 x 0.34 mm ² + 3 x 1.0 mm ² , Ø 8.8 mm	PA	10...30 DC	-25...80	IP 67 / IP 68	green / 12 x yellow	21	EBC020
	10 m black PUR cable	12 x 0.34 mm ² + 3 x 1.0 mm ² , Ø 8.8 mm	PA	10...30 DC	-25...80	IP 67 / IP 68	green / 12 x yellow	21	EBC032
Group 105 · M12 splitter box for 2 signals · Wiring diagram no. 41									
	5 m black PUR cable	16 x 0.34 mm ² + 3 x 0.75 mm ² , Ø 9.7 mm	PA	30 AC/DC	-25...80	IP 67 / IP 68	–	12	EBC022
	10 m black PUR cable	16 x 0.34 mm ² + 3 x 0.75 mm ² , Ø 9.7 mm	PA	30 AC/DC	-25...80	IP 67 / IP 68	–	12	EBC034
Group 106 · M12 splitter box for 2 signals, LED · Wiring diagram no. 42									
	5 m black PUR cable	16 x 0.34 mm ² + 3 x 1.0 mm ² , Ø 9.7 mm	PA	10...30 DC	-25...80	IP 67 / IP 68	green / 16 x yellow	22	EBC024
	10 m black PUR cable	16 x 0.34 mm ² + 3 x 1.0 mm ² , Ø 9.7 mm	PA	10...30 DC	-25...80	IP 67 / IP 68	green / 16 x yellow	22	EBC036

Type	Cable	Wire specification	Material housing / nut	U [V]	T _a [°C]	Protection	LEDs	Drawing no.	Order no.
Group 107 · M12 splitter box for 2 signals · Wiring diagram no. 9									
	M23 connector	–	PA	30 AC/DC	-25...80	IP 67	–	23	EBC003
Group 108 · M12 splitter box for 2 signals, LED · Wiring diagram no. 43									
	M23 connector	–	PA	10...30 DC	-25...80	IP 67	green / 8 x yellow	24	EBC004
Group 109 · M12 splitter box for 2 signals · Wiring diagram no. 10									
	M23 connector	–	PA	30 AC/DC	-25...80	IP 67	–	25	EBC007
Group 110 · M12 splitter box for 2 signals, LED · Wiring diagram no. 44									
	M23 connector	–	PA	10...30 DC	-25...80	IP 67	green / 12 x yellow	26	EBC008
Group 111 · M12 splitter box for 2 signals · Wiring diagram no. 11									
	M23 connector	–	PA	30 AC/DC	-25...80	IP 67	–	27	EBC011
Group 112 · M12 splitter box for 2 signals, LED · Wiring diagram no. 45									
	M23 connector	–	PA	10...30 DC	-25...80	IP 67	green / 16 x yellow	28	EBC012
Group 113 · Y splitter , 5-pole · Wiring diagram no. 12									
	M12 connector	–	PUR / diecast zinc	60 DC	-25...85	IP 67	–	29	E12481
Group 114 · Y splitter M12-plug / 2x M8-socket, 4/3-pole · Wiring diagram no. 13									
		–	PA / Brass	50 AC 60 DC	-25...90	IP 65 / IP 67 / IP 68 / IP 69K	–	30	EBC112
Group 115 · Y splitter M12-plug / 2 x M12-socket, 5-pole · Wiring diagram no. 13									
		–	PA / Brass	250 AC 300 DC	-25...90	IP 65 / IP 67 / IP 68 / IP 69K	–	31	EBC113
Group 116 · Y splitter M12-plug / 2 x M12-socket, 5-pole · Wiring diagram no. 16									
		–	PA / Brass	60 AC 60 DC	-25...90	IP 65 / IP 67 / IP 68 / IP 69K	–	31	EBC114

You can find wiring diagrams and scale drawings from page 844



Connection technology

Type	Cable	Wire specification	Material housing / nut	U [V]	T _a [°C]	Protection	LEDs	Drawing no.	Order no.
Group 117 · Y splitter M12-plug / 2 x M12-socket, 5-pole · Wiring diagram no. 14									
		–	PA / Brass	60 AC 60 DC	-25...90	IP 65 / IP 67 / IP 68 / IP 69K	–	31	EBC115
Group 118 · Y splitter M12-plug / 2 x M12-socket, 5-pole · Wiring diagram no. 15									
		–	PA / Brass	60 AC 60 DC	-25...90	IP 65 / IP 67 / IP 68 / IP 69K	–	31	EBC116
Group 119 · Y splitter M12-plug / 2 x M12-socket, 5-pole · Wiring diagram no. 17									
		–	PA / Brass	60 AC 60 DC	-25...90	IP 65 / IP 67 / IP 68 / IP 69K	–	31	EBC117
Group 120 · Y splitter M12-plug / 2 x M12-socket, 5-pole · Wiring diagram no. 18									
		–	PA / Brass	60 AC 60 DC	-25...90	IP 65 / IP 67 / IP 68 / IP 69K	–	31	EBC118
Group 121 · splitter box M8, 3-pole, LED · Wiring diagram no. 48									
	5 m black PUR cable	10 x 0.34 mm ² + 2 x 0.75 mm ² , Ø 9.1 mm	PBT-GF 20	10...30 DC	-25...80	IP 65 / IP 67 / IP 68	green / 10 x yellow	35	EBC136
	10 m black PUR cable	10 x 0.34 mm ² + 2 x 0.75 mm ² , Ø 9.1 mm	PBT-GF 20	10...30 DC	-25...80	IP 65 / IP 67 / IP 68	green / 10 x yellow	35	EBC137
Group 122 · splitter box M8, 4-pole, LED · Wiring diagram no. 46									
	M12 connector	–	PBT-GF 20	15...30 DC	-25...80	IP 67 / IP 68	green / 8 x yellow	34	EBC138
Group 123 · splitter box M8, 4-pole, LED · Wiring diagram no. 47									
	M12 connector	–	PBT-GF 20	15...30 DC	-25...80	IP 67 / IP 68	green / 10 x yellow	36	EBC139
Group 124 · Y splitter M12-plug / 2 x M12-socket, 4/5-pole · Wiring diagram no. 13									
		–	PA / stainless steel 316L / 1.4404	250 AC 300 DC	-25...100	IP 65 / IP 67 / IP 68 / IP 69K	–	32	EBT006
Group 125 · Y splitter M12-plug / 2 x M12-socket, 5-pole · Wiring diagram no. 16									
		–	PA / stainless steel 316L / 1.4404	60 AC 60 DC	-25...100	IP 65 / IP 67 / IP 68 / IP 69K	–	33	EBT007

Type	Cable	Wire specification	Material housing / nut	U [V]	T _a [°C]	Protection	LEDs	Drawing no.	Order no.
------	-------	--------------------	------------------------	-------	---------------------	------------	------	-------------	-----------

Group 126 · Y splitter M12-plug / 2 x M12-socket, 5-pole · Wiring diagram no. 14

		–	PA / stainless steel 316L / 1.4404	60 AC 60 DC	-25...100	IP 65 / IP 67 / IP 68 / IP 69K	–	33	EBT008
---	--	---	------------------------------------	----------------	-----------	-----------------------------------	---	----	--------

Group 127 · Y splitter M12-plug / 2 x M12-socket, 5-pole · Wiring diagram no. 15

		–	PA / stainless steel 316L / 1.4404	60 AC 60 DC	-25...100	IP 65 / IP 67 / IP 68 / IP 69K	–	33	EBT009
---	--	---	------------------------------------	----------------	-----------	-----------------------------------	---	----	--------

Group 128 · Y splitter M12-plug / 2 x M12-socket, 5-pole · Wiring diagram no. 19

		–	PA / stainless steel 316L / 1.4404	60 AC 60 DC	-25...100	IP 65 / IP 67 / IP 68 / IP 69K	–	33	EBT010
---	--	---	------------------------------------	----------------	-----------	-----------------------------------	---	----	--------

Group 129 · Y splitter M12-plug / 2 x M12-socket, 5-pole · Wiring diagram no. 18

		–	PA / stainless steel 316L / 1.4404	60 AC 60 DC	-25...100	IP 65 / IP 67 / IP 68 / IP 69K	–	33	EBT011
--	--	---	------------------------------------	----------------	-----------	-----------------------------------	---	----	--------

Splitter boxes for hygienic and wet areas

Type	Cable	Wire specification	Material housing / nut	U [V]	T _a [°C]	Protection	LEDs	Drawing no.	Order no.
------	-------	--------------------	------------------------	-------	---------------------	------------	------	-------------	-----------

Group 130 · splitter box M12, LED · Wiring diagram no. 42

	10 m black PUR / PVC cable	3 x 0.75 mm ² + 16 x 0.34 mm ² , Ø 11 mm	high-grade stainless steel	10...36 DC	-5...70	IP 69K	green / 16 x yellow	37	E11775
---	----------------------------	--	----------------------------	------------	---------	--------	---------------------	----	--------

Group 131 · Y splitter M12-plug / 2 x M12-socket, 4/5-pole · halogen-free · Wiring diagram no. 13

		–	PP / stainless steel 316L / 1.4404	250 AC 300 DC	-25...100	IP 65 / IP 67 / IP 68 / IP 69K	–	32	EBF006
---	--	---	------------------------------------	------------------	-----------	-----------------------------------	---	----	--------

Group 132 · Y splitter M12-plug / 2 x M12-socket, 5-pole · halogen-free · Wiring diagram no. 16

		–	PP / stainless steel 316L / 1.4404	60 AC 60 DC	-25...100	IP 65 / IP 67 / IP 68 / IP 69K	–	33	EBF007
---	--	---	------------------------------------	----------------	-----------	-----------------------------------	---	----	--------

Group 133 · Y splitter M12-plug / 2 x M12-socket, 5-pole · halogen-free · Wiring diagram no. 14

		–	PP / stainless steel 316L / 1.4404	60 AC 60 DC	-25...100	IP 65 / IP 67 / IP 68 / IP 69K	–	33	EBF008
---	--	---	------------------------------------	----------------	-----------	-----------------------------------	---	----	--------

Group 134 · Y splitter M12-plug / 2 x M12-socket, 5-pole · halogen-free · Wiring diagram no. 15

		–	PP / stainless steel 316L / 1.4404	60 AC 60 DC	-25...100	IP 65 / IP 67 / IP 68 / IP 69K	–	33	EBF009
---	--	---	------------------------------------	----------------	-----------	-----------------------------------	---	----	--------

You can find wiring diagrams and scale drawings from page 844



Connection technology

Type	Cable	Wire specification	Material housing / nut	U [V]	T _a [°C]	Protection	LEDs	Drawing no.	Order no.
------	-------	--------------------	------------------------	-------	---------------------	------------	------	-------------	-----------

Group 135 · Y splitter M12-plug / 2 x M12-socket, 5-pole · halogen-free · Wiring diagram no. 19



–			PP / stainless steel 316L / 1.4404	60 AC 60 DC	-25...100	IP 65 / IP 67 / IP 68 / IP 69K	–	33	EBF010
---	--	--	------------------------------------	----------------	-----------	-----------------------------------	---	----	---------------

Group 136 · Y splitter M12-plug / 2 x M12-socket, 5-pole · halogen-free · Wiring diagram no. 18



–			PP / stainless steel 316L / 1.4404	60 AC 60 DC	-25...100	IP 65 / IP 67 / IP 68 / IP 69K	–	33	EBF011
---	--	--	------------------------------------	----------------	-----------	-----------------------------------	---	----	---------------

Wiring diagrams

Core colours

BK	black
BN	brown
BU	blue
WH	white
GN	green
GY	grey
YE	yellow
PK	pink
RD	red
VT	purple
GN/YE	green/yellow

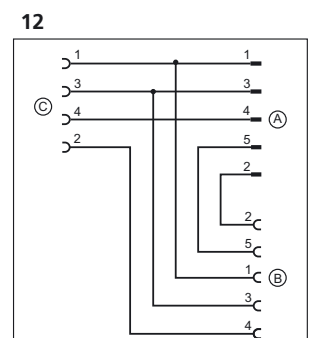
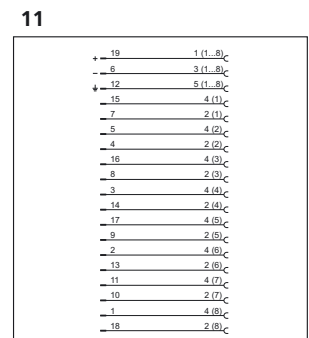
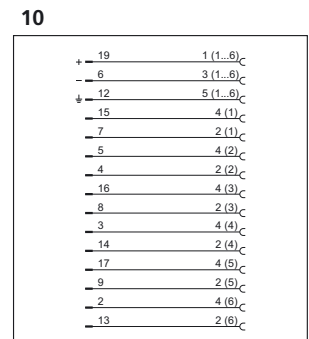
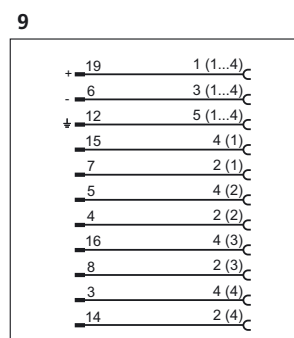
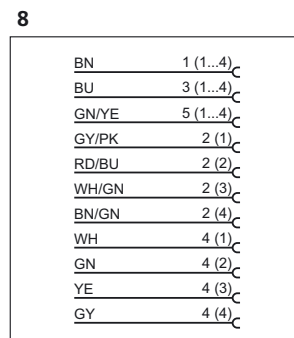
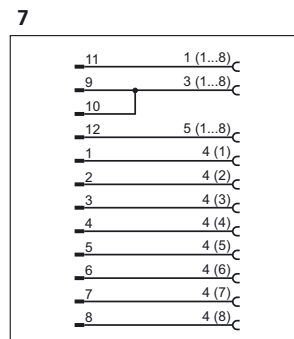
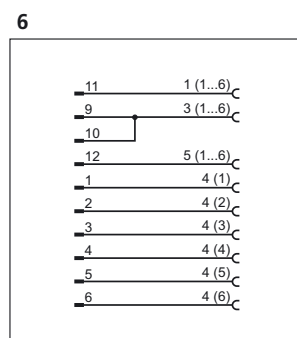
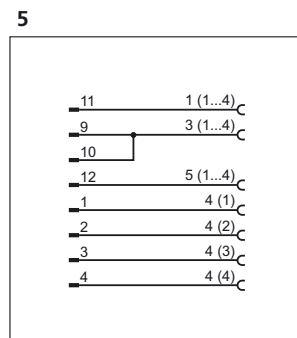
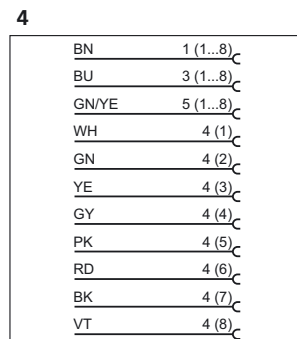
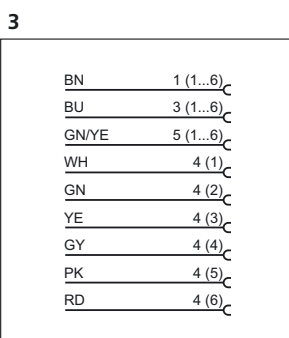
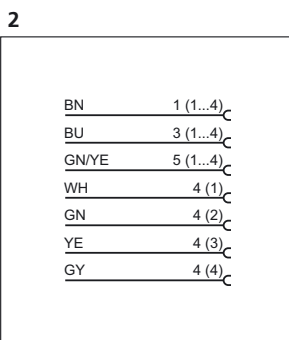
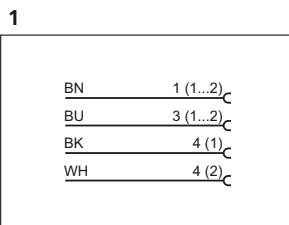

Wiring diagrams

13

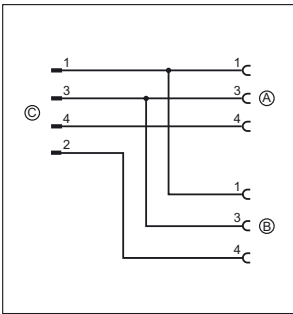

15

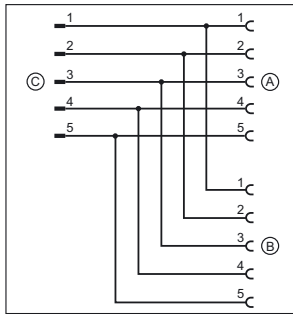

17

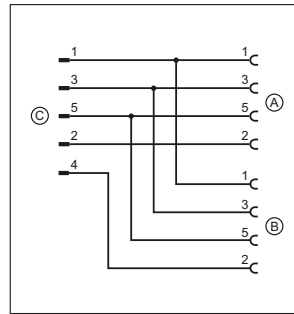

19

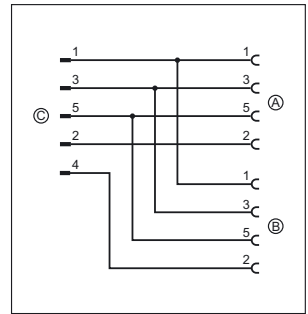

14

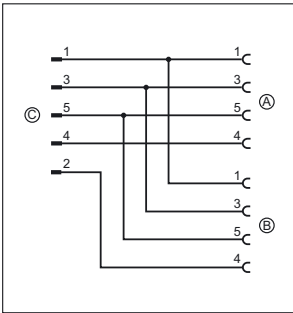

16

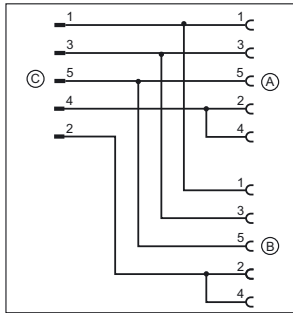

18

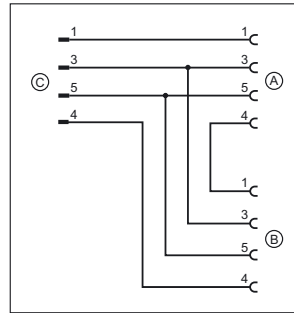

20

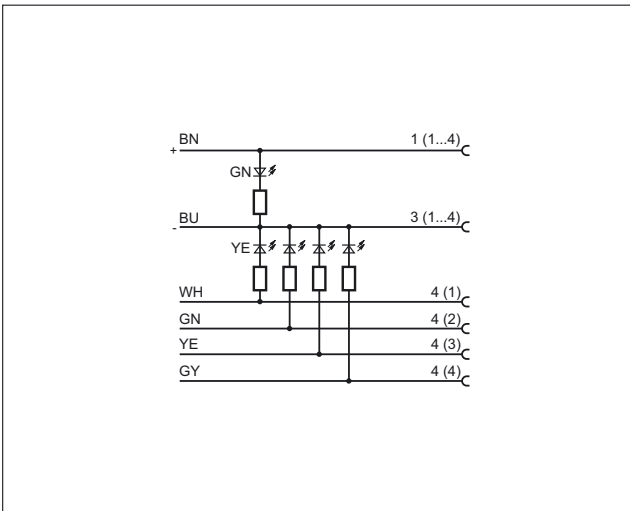

22

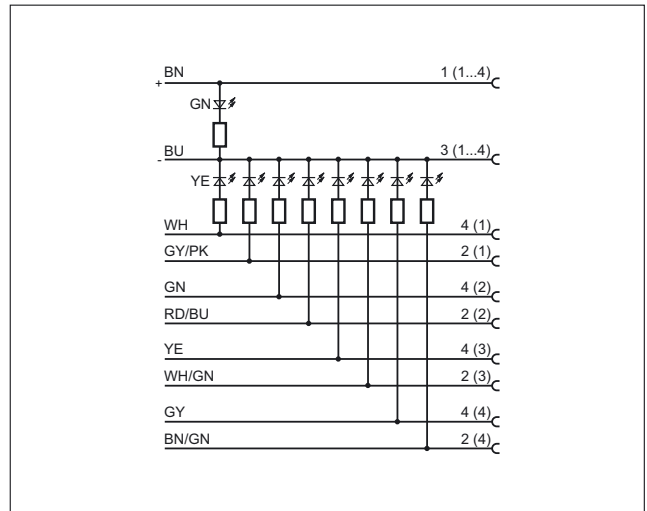

21

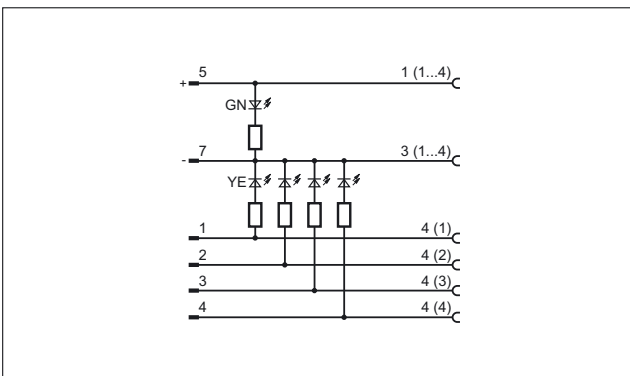

23

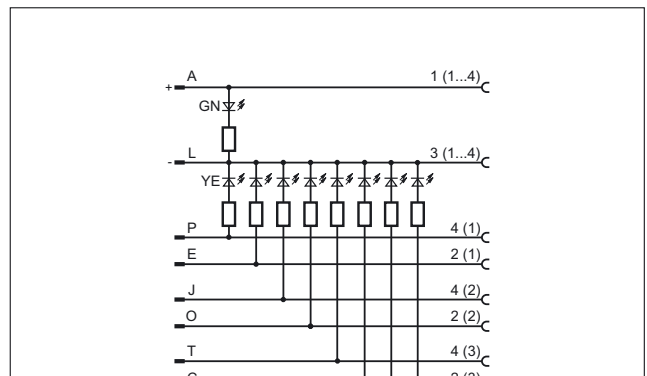



Wiring diagrams

24

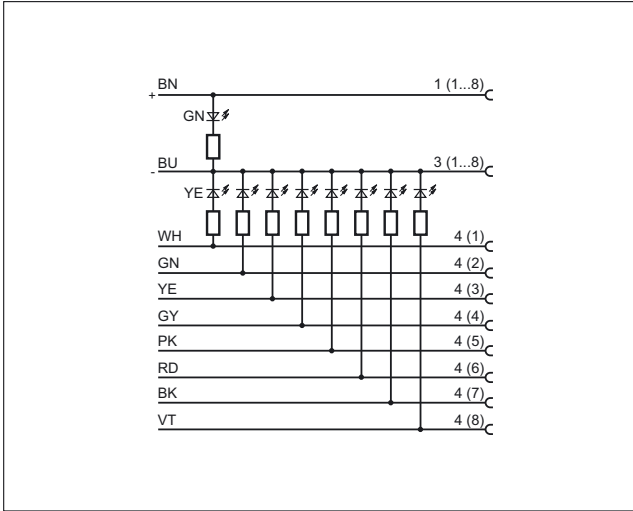

27

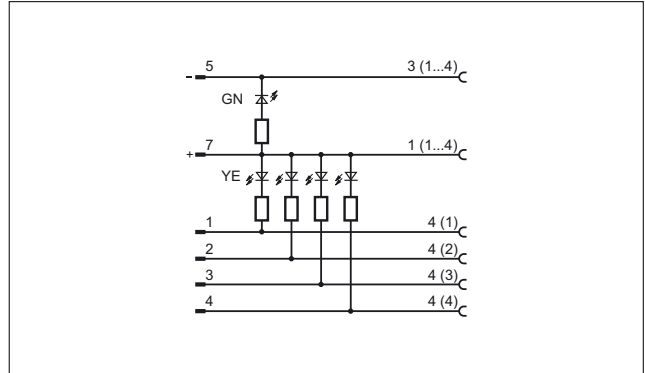

25

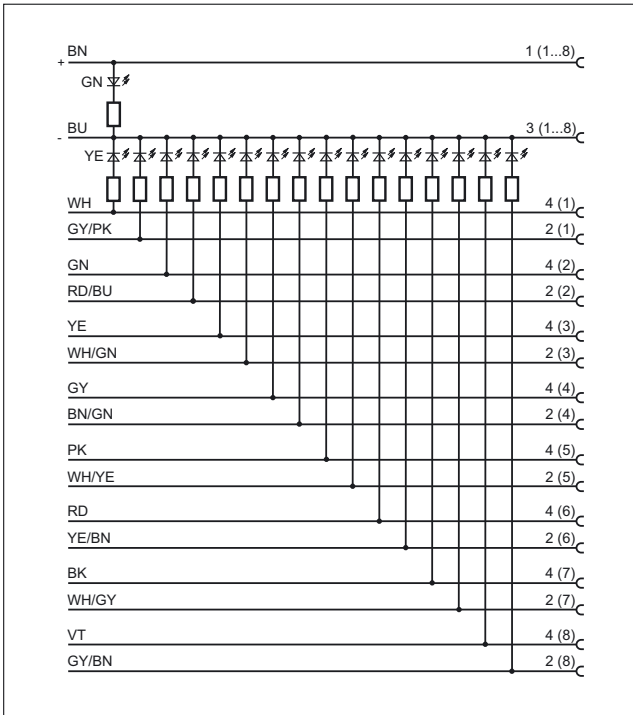

28

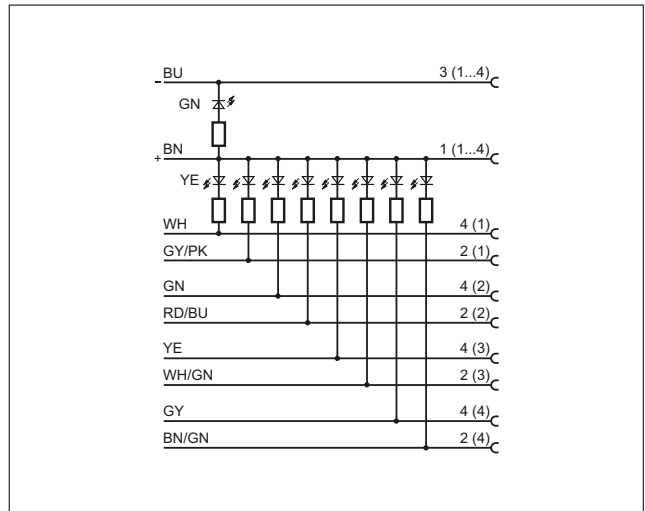

26

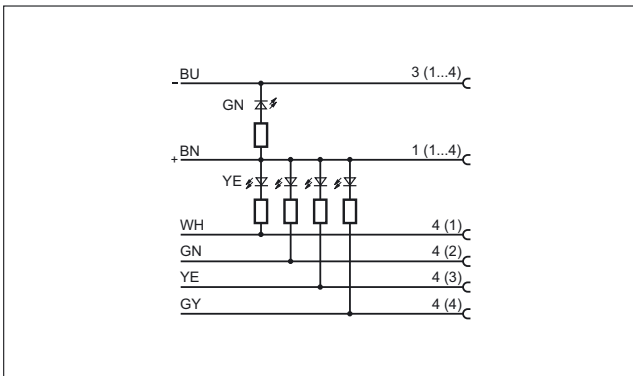

29

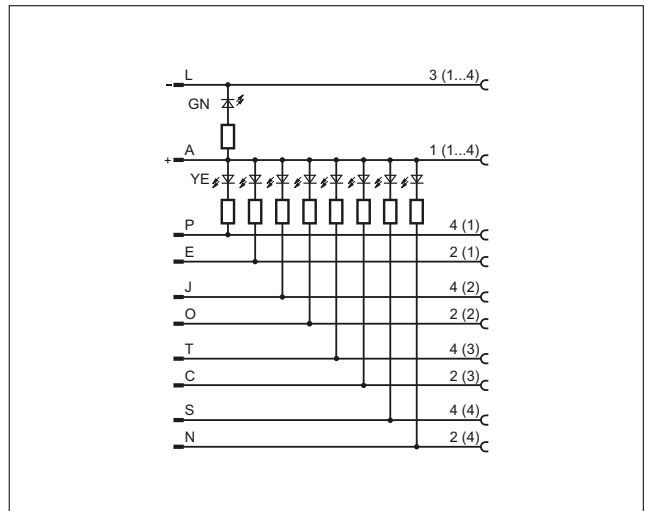

Wiring diagrams

30

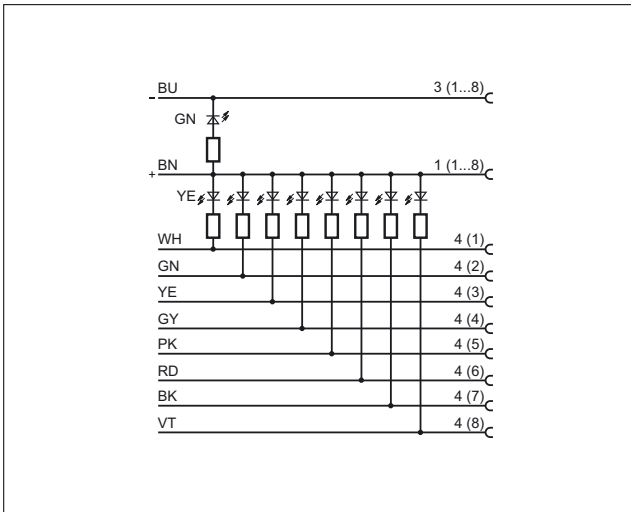

31

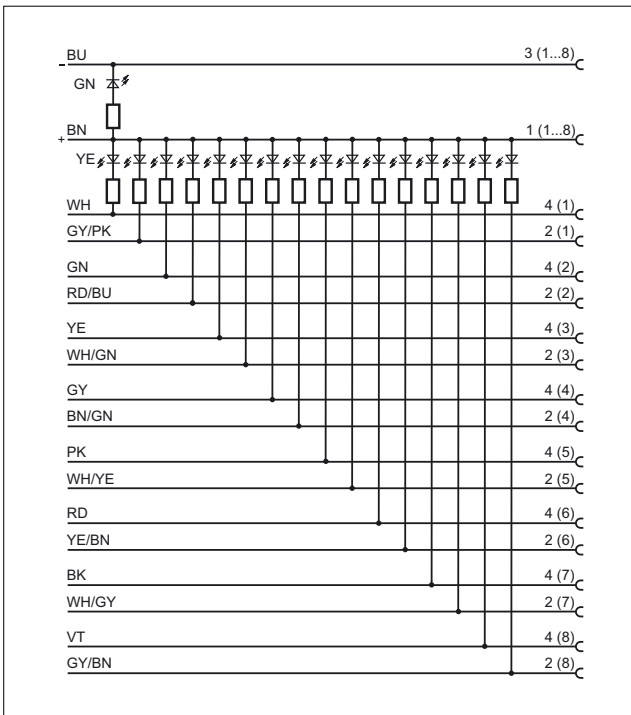

32

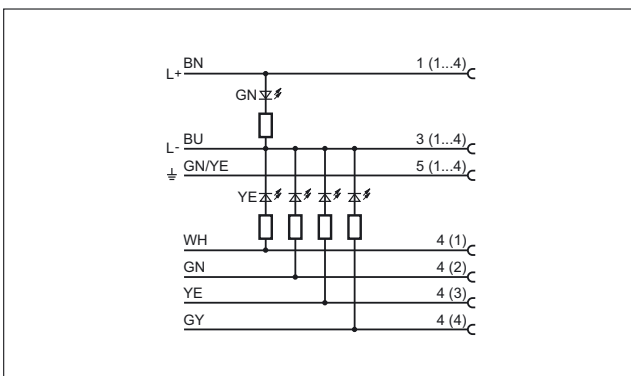

33

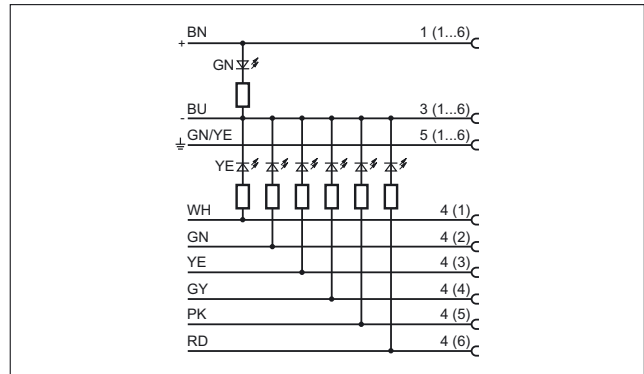

34

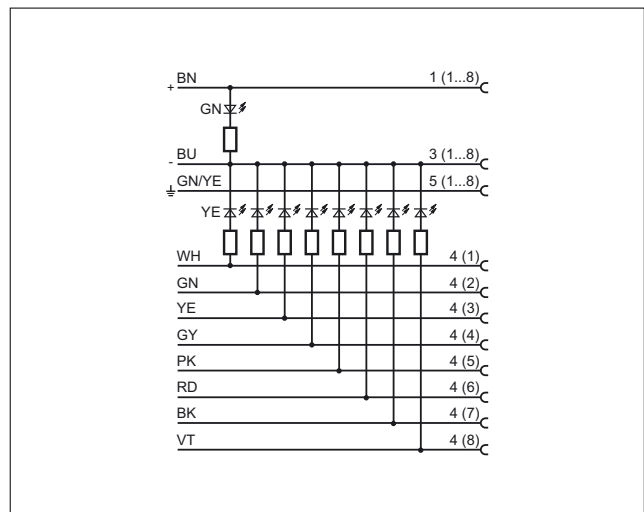

35

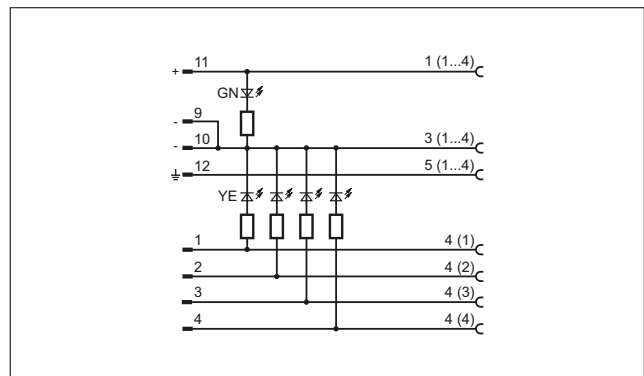

36

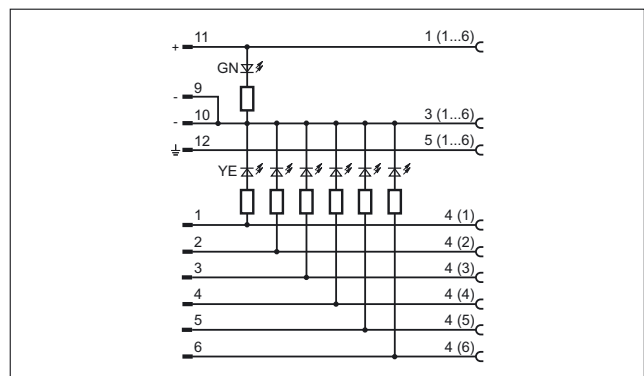



Connection technology

Wiring diagrams

37

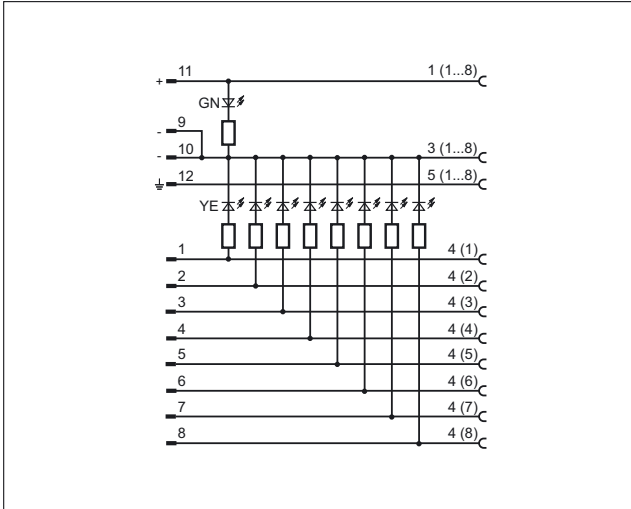

38

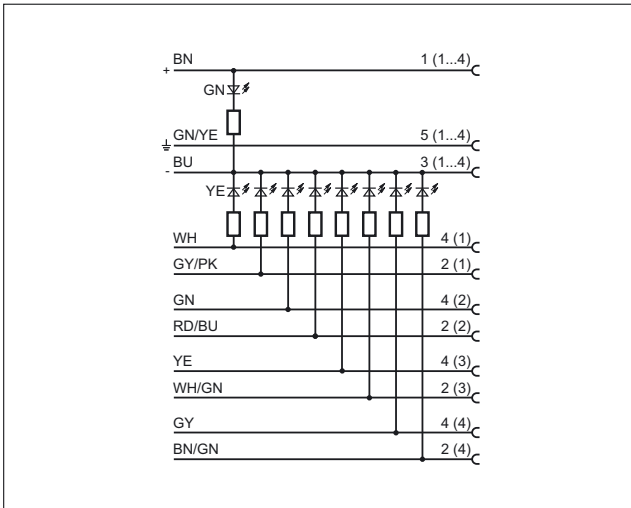

39

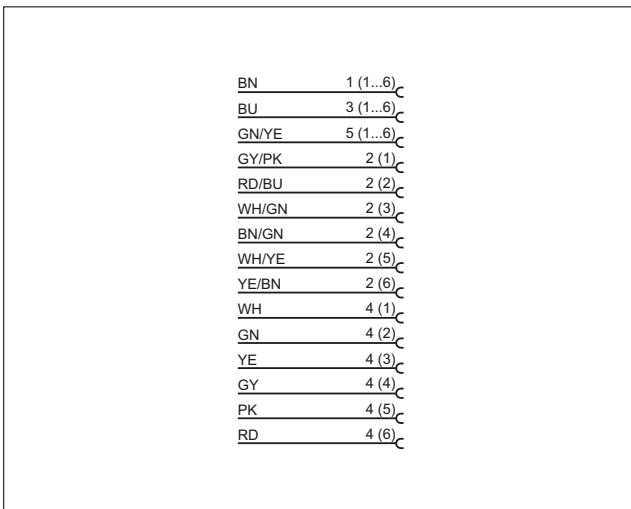

40

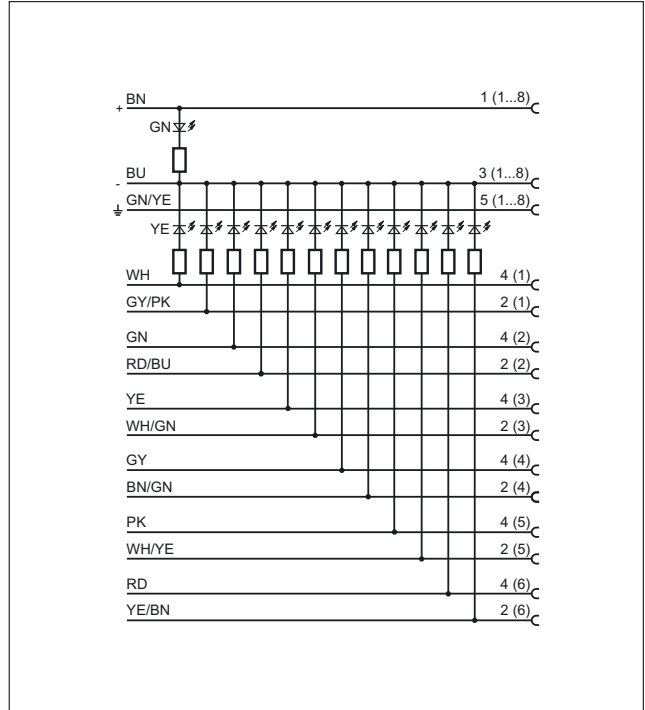

41

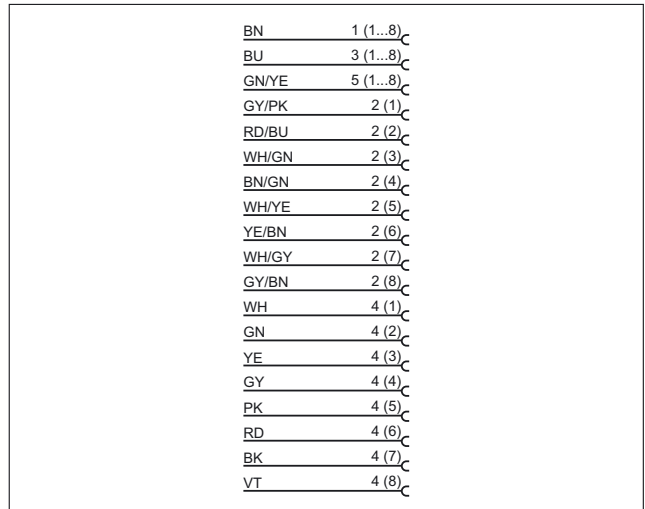

Wiring diagrams

42

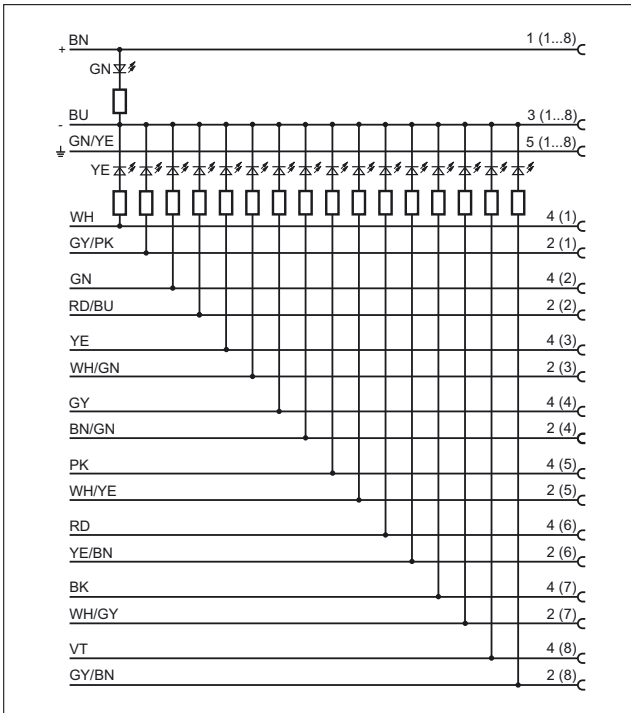

44

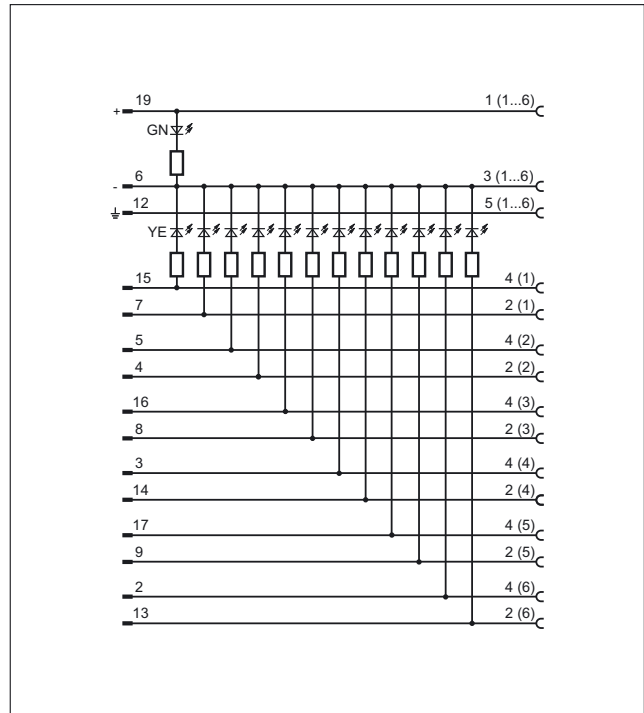

43

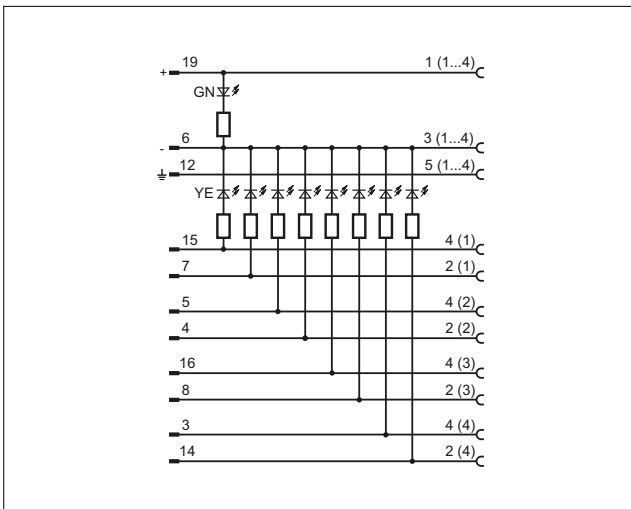

45

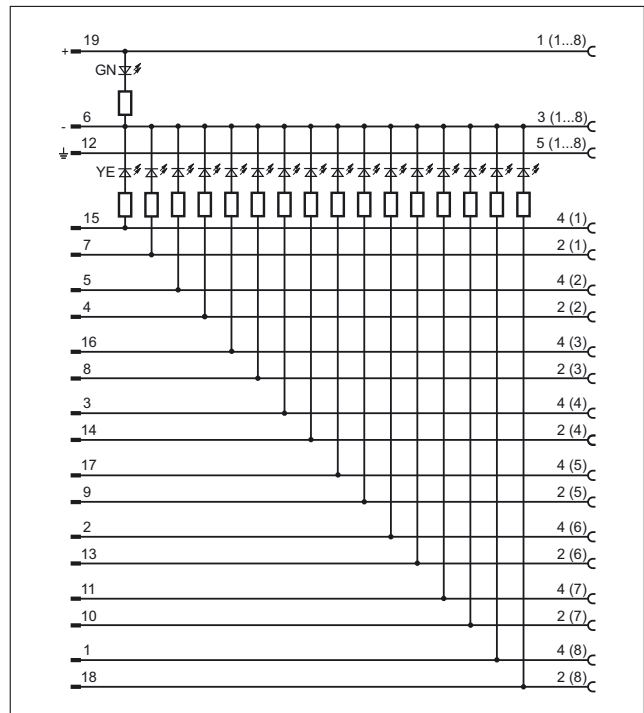



Connection technology

Wiring diagrams

46

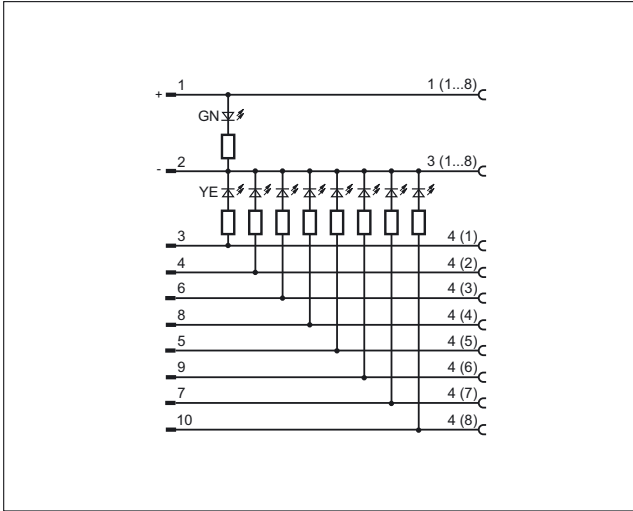

47

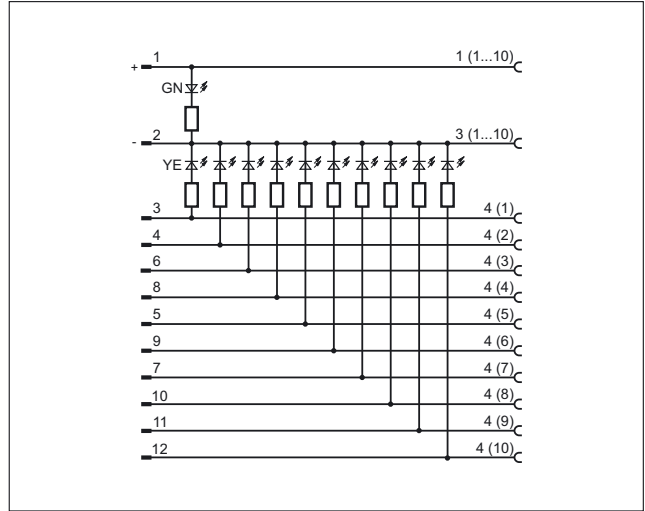

48

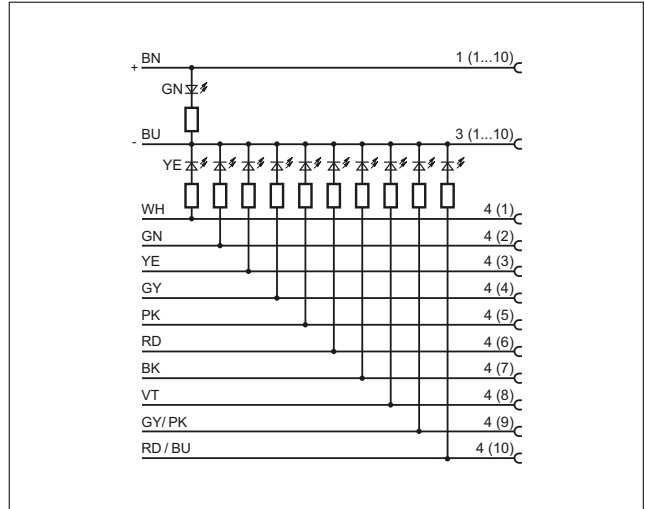

Scale drawings / drawing no. – CAD download: www.ifm.com

1

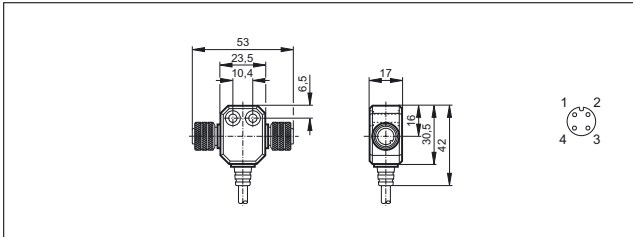

3

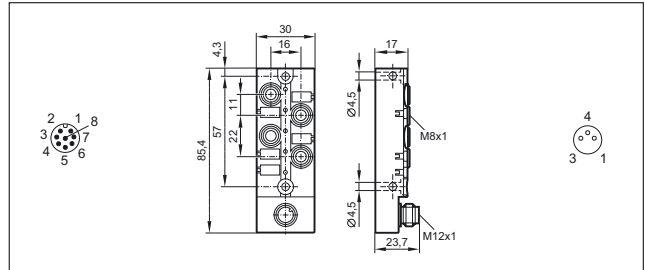

2

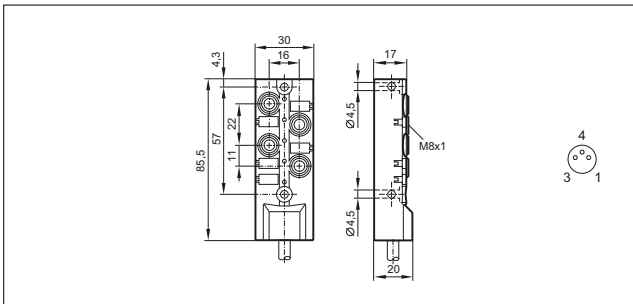

4

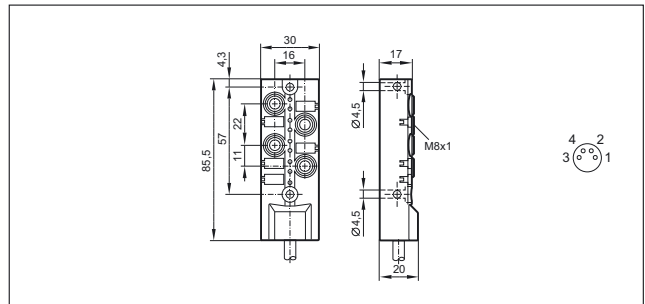

Scale drawings / drawing no. – CAD download: www.ifm.com

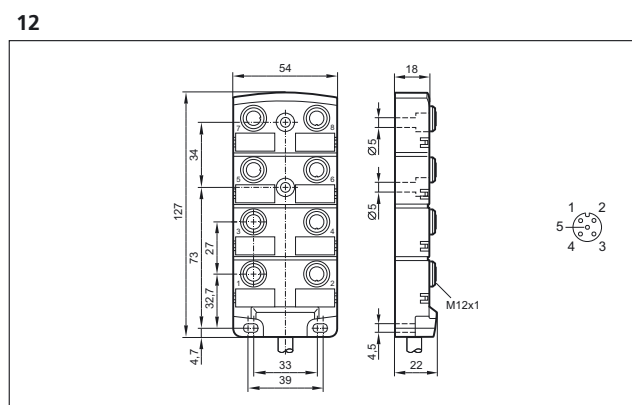
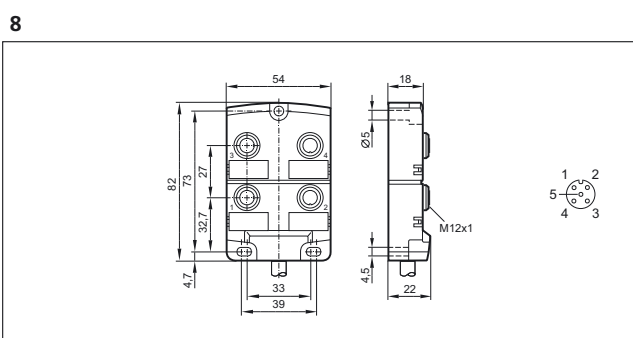
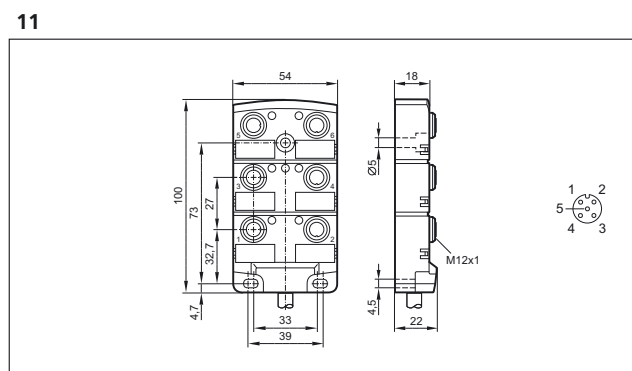
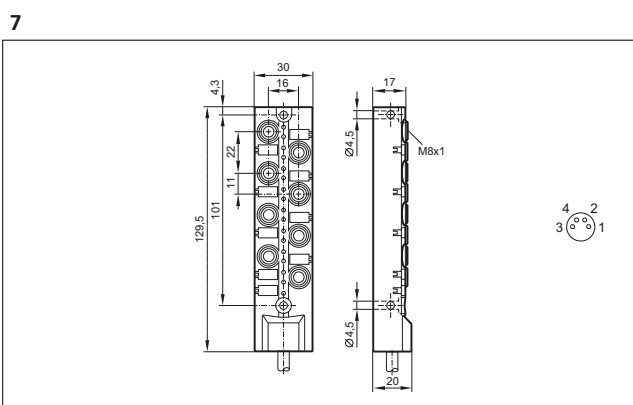
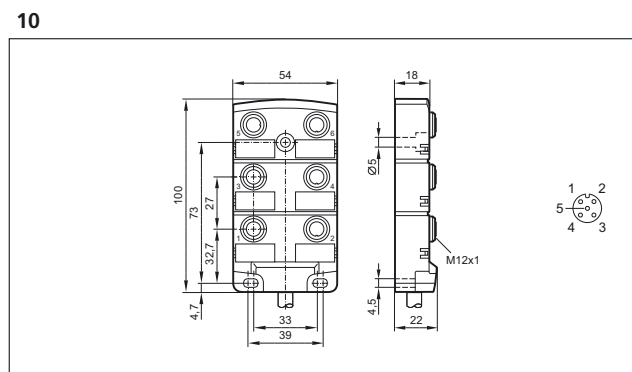
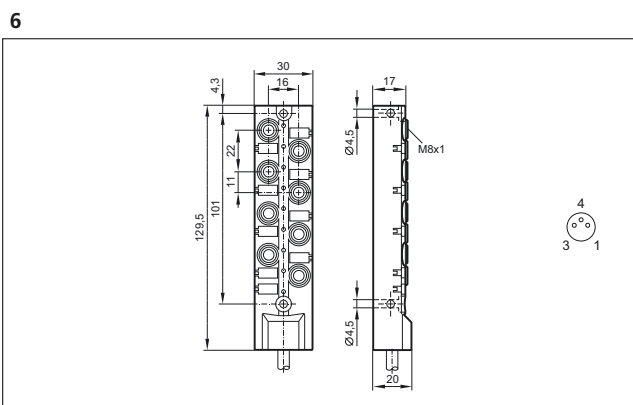
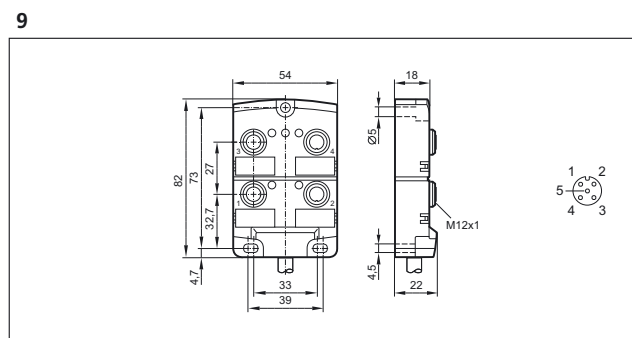
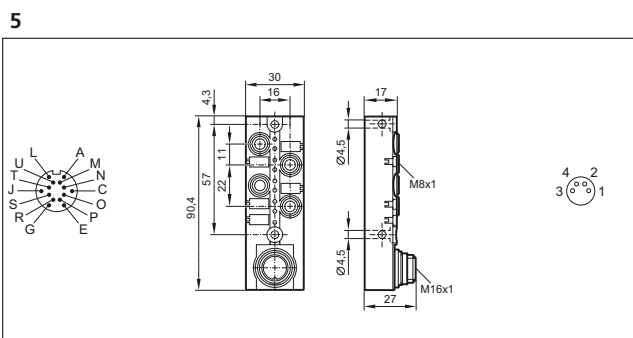



Connection technology

Scale drawings / drawing no. – CAD download: www.ifm.com

13

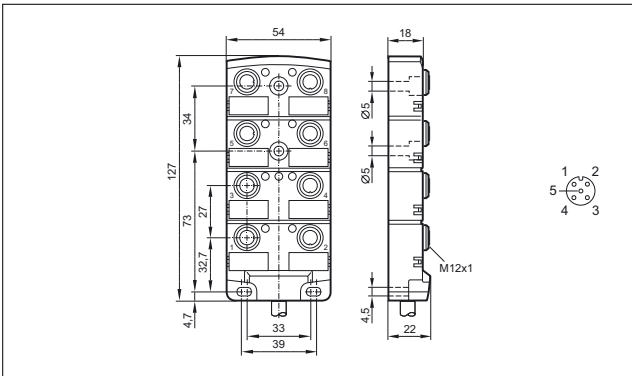

16

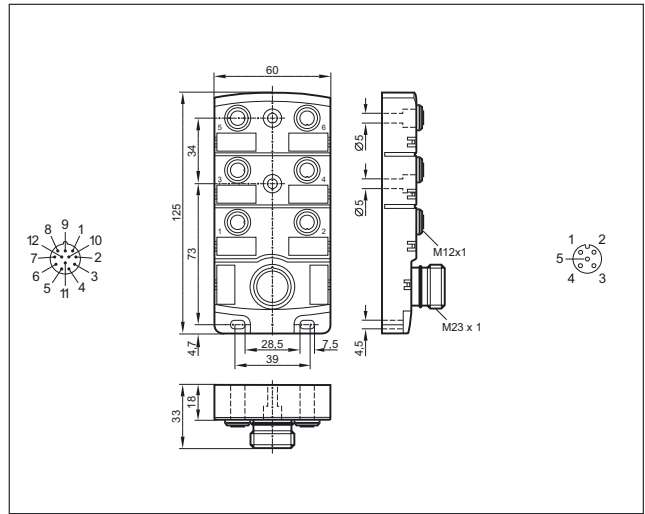

14

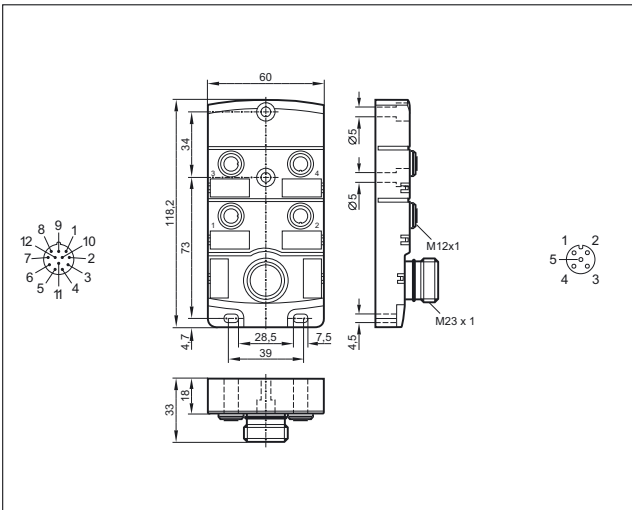

17

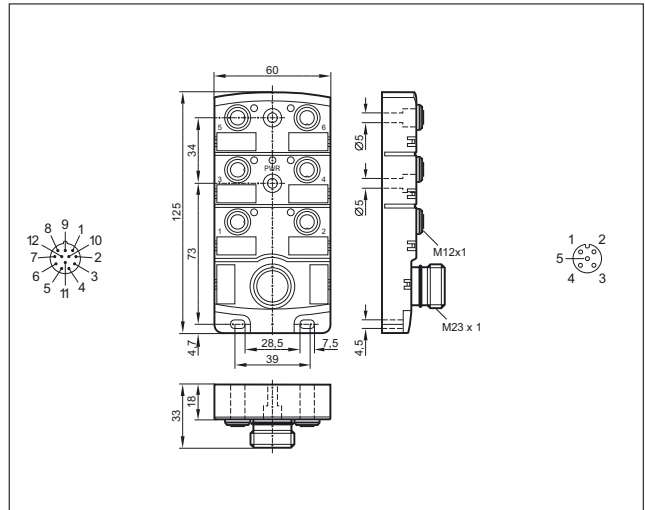

15

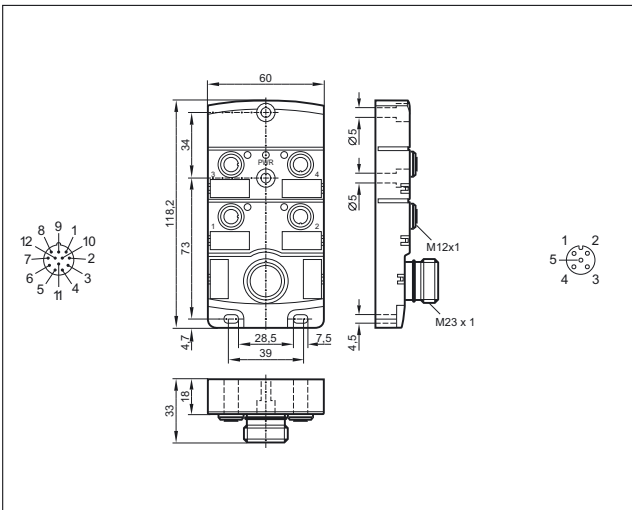

18

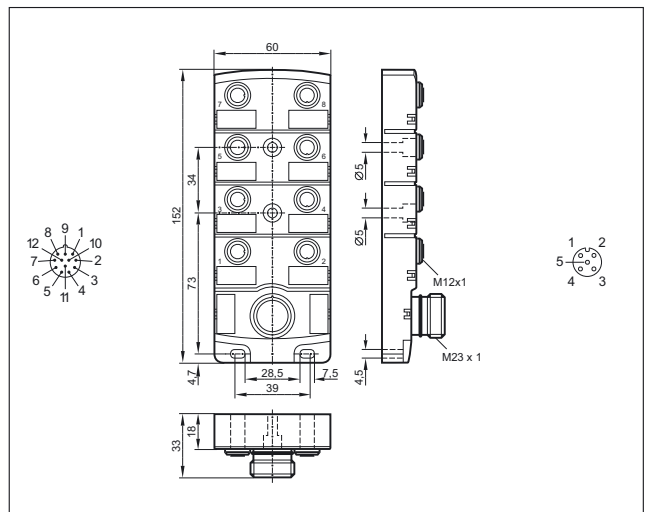

Scale drawings / drawing no. – CAD download: www.ifm.com

19

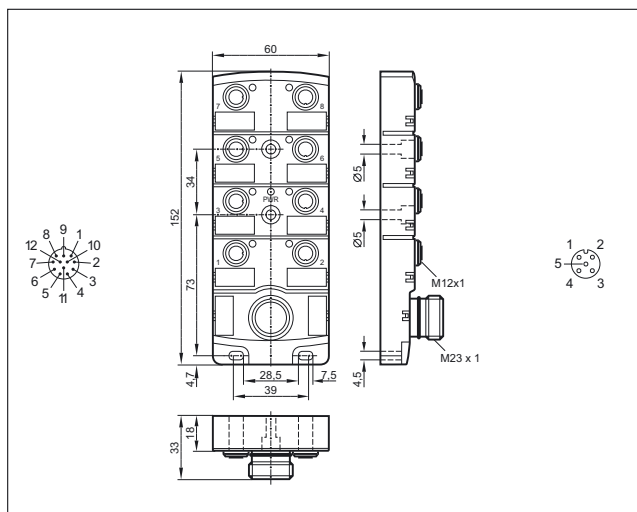

23

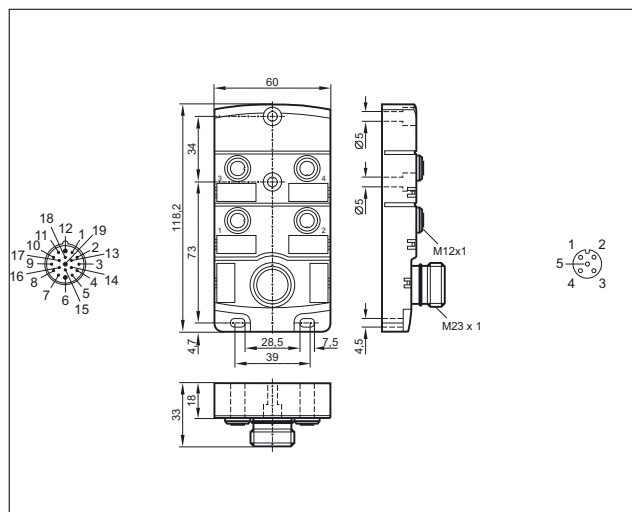

20

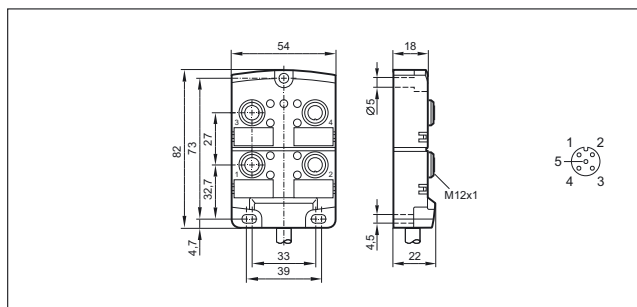

24

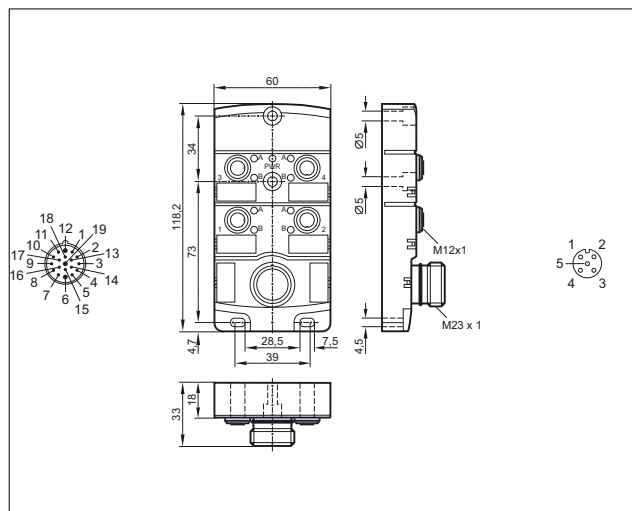

21

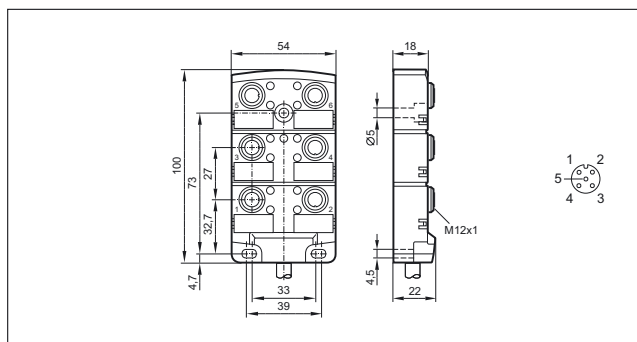

25

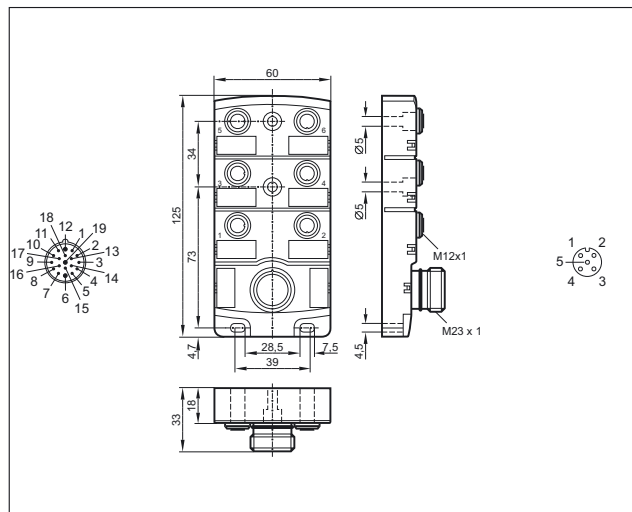

22

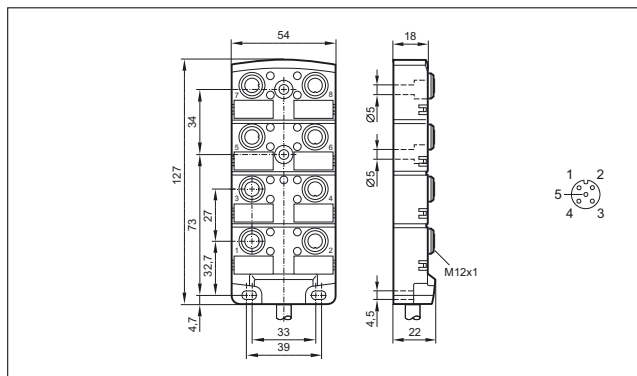



Scale drawings / drawing no. – CAD download: www.ifm.com

26

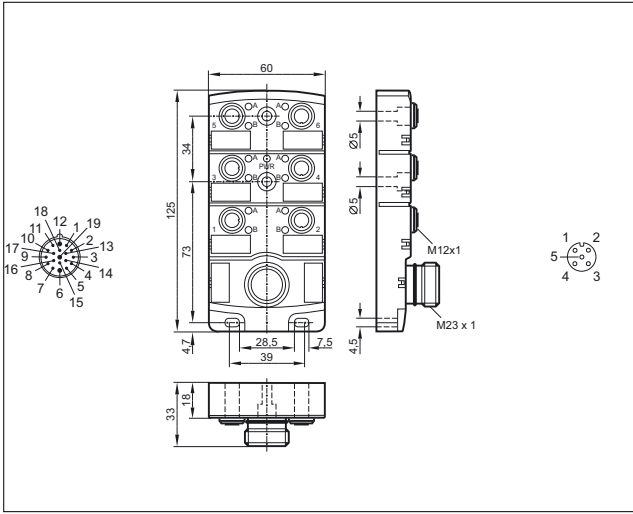

29

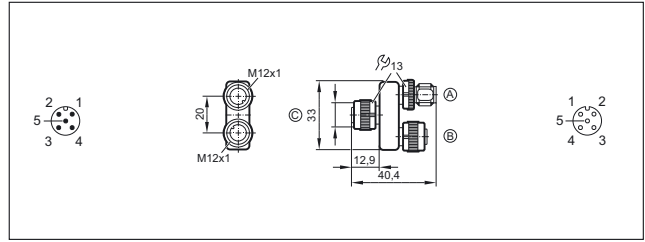

30

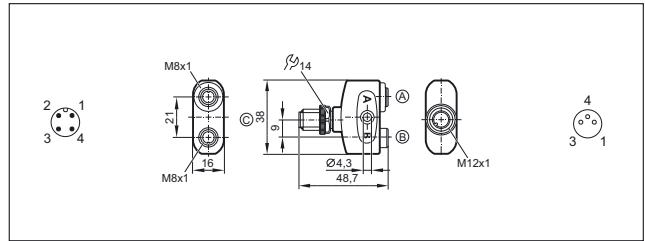

27

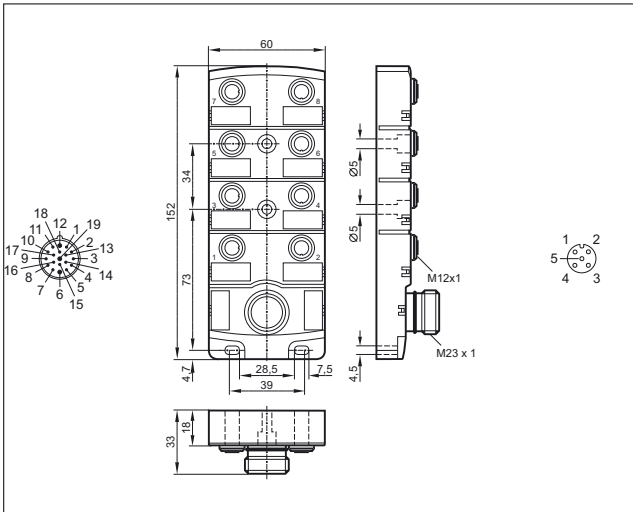

31

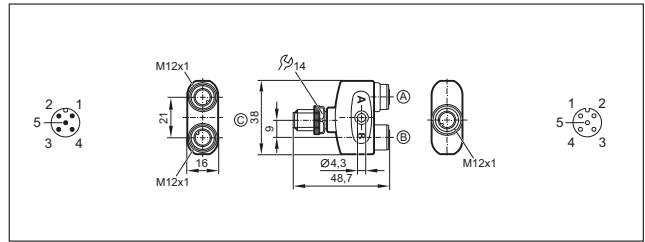

32

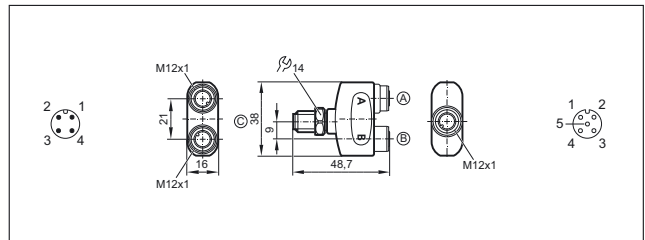

28

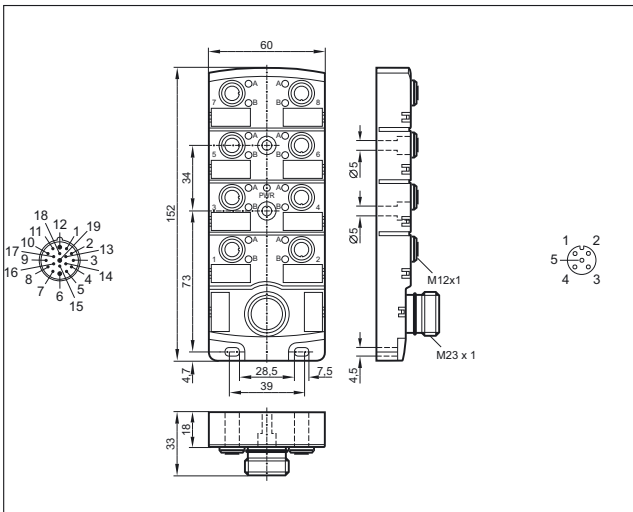

33

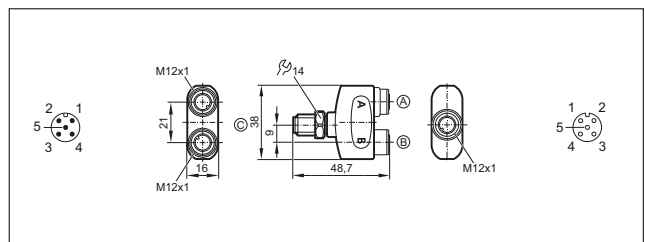

34

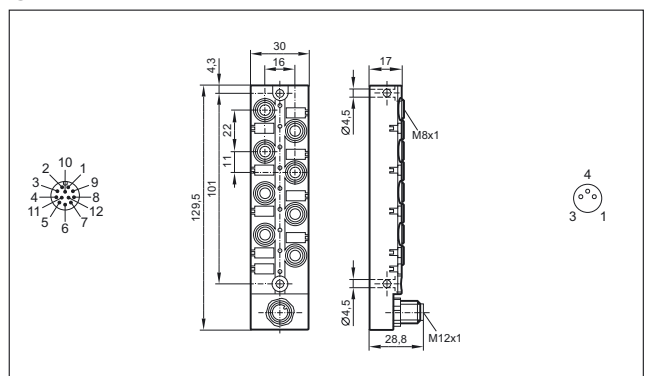

Scale drawings / drawing no. – CAD download: www.ifm.com

35

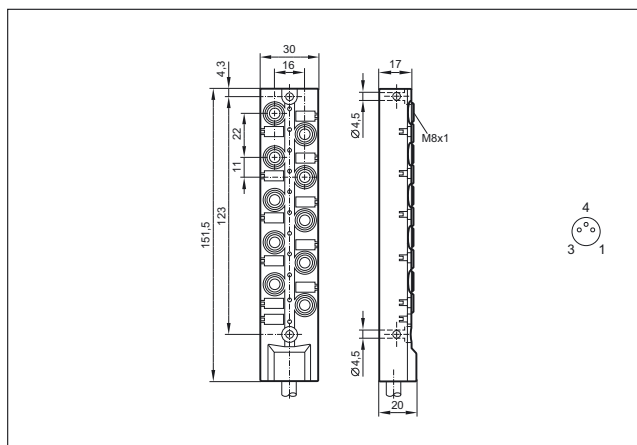

36

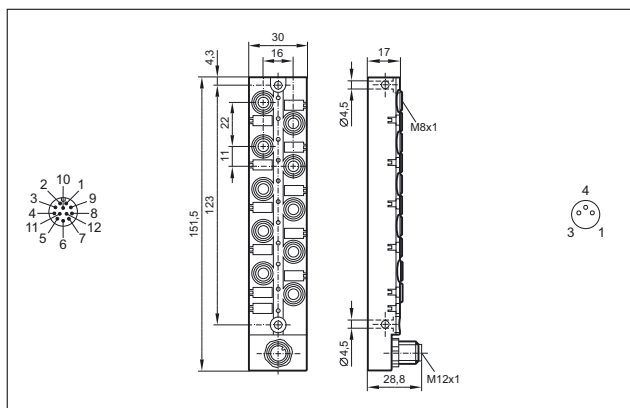

37

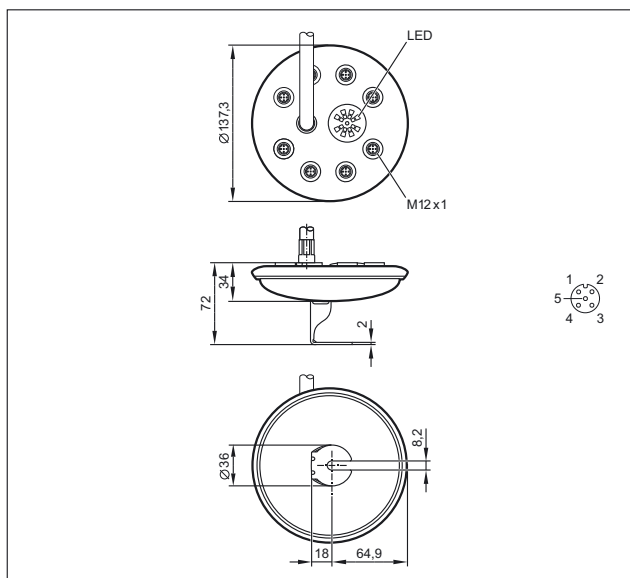



Connection technology







Y-splitters

Y connection cables are used for the distribution of signals and the connection of two units to a connector.

System overview	Page
M12 – M12 jumpers for industrial applications	856 - 857
Jumpers for hygienic and wet areas	857 - 858
Connection cables for industrial applications	858 - 859
Wiring diagrams	859
Scale drawings / drawing no. – CAD download: www.ifm.com	860

M12 – M12 jumpers for industrial applications

Type	Cable	Wire specification	Material housing / nut	U [V]	T _a [°C]	Protection	LEDs	Drawing no.	Order no.
Group 60 · Y connection cable , plug: M12, 5-pole, socket: M12, 5-pole, 5-wire · Wiring diagram no. 1									
	1 m black PUR cable	4 x 0.34 mm ² , Ø 4.9 mm	TPU / Brass	60 AC 60 DC	-25...90	IP 65 / IP 67 / IP 68 / IP 69K	–	1	EVC431
	2 m black PUR cable	4 x 0.34 mm ² , Ø 4.9 mm	TPU / Brass	60 AC 60 DC	-25...90	IP 65 / IP 67 / IP 68 / IP 69K	–	1	EVC432
	5 m black PUR cable	4 x 0.34 mm ² , Ø 4.9 mm	TPU / Brass	60 AC 60 DC	-25...90	IP 65 / IP 67 / IP 68 / IP 69K	–	1	EVC433
	1 m black PUR cable	4 x 0.34 mm ² , Ø 4.9 mm	TPU / Brass	60 AC 60 DC	-25...90	IP 65 / IP 67 / IP 68 / IP 69K	–	2	EVC434
	2 m black PUR cable	4 x 0.34 mm ² , Ø 4.9 mm	TPU / Brass	60 AC 60 DC	-25...90	IP 65 / IP 67 / IP 68 / IP 69K	–	2	EVC435
	5 m black PUR cable	4 x 0.34 mm ² , Ø 4.9 mm	TPU / Brass	60 AC 60 DC	-25...90	IP 65 / IP 67 / IP 68 / IP 69K	–	2	EVC436
Group 62 · Y connection cable , plug: M12, 4-pole, socket: M12, 5-pole, 5-wire, LED, PNP · Wiring diagram no. 6									
	1 m black PUR cable	3 x 0.34 mm ² , Ø 4.9 mm	TPU / Brass	10...36 DC	-25...90	IP 65 / IP 67 / IP 68 / IP 69K	green / yellow	3	EVC437





Product selectors and further information can be found at: www.ifm.com

Type	Cable	Wire specification	Material housing / nut	U [V]	T _a [°C]	Protection	LEDs	Drawing no.	Order no.
------	-------	--------------------	------------------------	-------	---------------------	------------	------	-------------	-----------

Group 62 · Y connection cable , plug: M12, 4-pole, socket: M12, 5-pole, 5-wire, LED, PNP · Wiring diagram no. 6

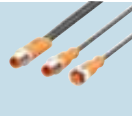
	2 m black PUR cable	3 x 0.34 mm ² , Ø 4.9 mm	TPU / Brass	10...36 DC	-25...90	IP 65 / IP 67 / IP 68 / IP 69K	green / yellow	3	EVC438
	5 m black PUR cable	3 x 0.34 mm ² , Ø 4.9 mm	TPU / Brass	10...36 DC	-25...90	IP 65 / IP 67 / IP 68 / IP 69K	green / yellow	3	EVC439





Group 64 · Y connection cable , 5-wire · B-port generator · Wiring diagram no. 7

	1 m black PUR cable	2 x 0.34 mm ² + 5 x 0.34 mm ² , Ø 4.9 mm	TPU / Brass	24 DC	-25...90	IP 65 / IP 67 / IP 68 / IP 69K	–	4	EVC693
	2 m black PUR cable	2 x 0.34 mm ² + 5 x 0.34 mm ² , Ø 4.9 mm	TPU / Brass	24 DC	-25...90	IP 65 / IP 67 / IP 68 / IP 69K	–	4	EVC694
	5 m black PUR cable	2 x 0.34 mm ² + 5 x 0.34 mm ² , Ø 4.9 mm	TPU / Brass	24 DC	-25...90	IP 65 / IP 67 / IP 68 / IP 69K	–	4	EVC695
	10 m black PUR cable	2 x 0.34 mm ² + 5 x 0.34 mm ² , Ø 4.9 mm	TPU / Brass	24 DC	-25...90	IP 65 / IP 67 / IP 68 / IP 69K	–	4	EVC696

Jumpers for hygienic and wet areas

Type	Cable	Wire specification	Material housing / nut	U [V]	T _a [°C]	Protection	LEDs	Drawing no.	Order no.
------	-------	--------------------	------------------------	-------	---------------------	------------	------	-------------	-----------

Group 161 · Y connection cable , plug: M12, 5-pole, socket: M12, 5-pole, 5-wire · Wiring diagram no. 1

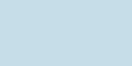
	1 m orange PVC cable	4 x 0.34 mm ² , Ø 4.9 mm	PVC / stainless steel 316L / 1.4404	60 AC 60 DC	-25...100	IP 65 / IP 67 / IP 68 / IP 69K	–	5	EVT329
	2 m orange PVC cable	4 x 0.34 mm ² , Ø 4.9 mm	PVC / stainless steel 316L / 1.4404	60 AC 60 DC	-25...100	IP 65 / IP 67 / IP 68 / IP 69K	–	5	EVT330
	5 m orange PVC cable	4 x 0.34 mm ² , Ø 4.9 mm	PVC / stainless steel 316L / 1.4404	60 AC 60 DC	-25...100	IP 65 / IP 67 / IP 68 / IP 69K	–	5	EVT331
	1 m orange PVC cable	4 x 0.34 mm ² , Ø 4.9 mm	PVC / stainless steel 316L / 1.4404	60 AC 60 DC	-25...100	IP 65 / IP 67 / IP 68 / IP 69K	–	6	EVT332
	2 m orange PVC cable	4 x 0.34 mm ² , Ø 4.9 mm	PVC / stainless steel 316L / 1.4404	60 AC 60 DC	-25...100	IP 65 / IP 67 / IP 68 / IP 69K	–	6	EVT333
	5 m orange PVC cable	4 x 0.34 mm ² , Ø 4.9 mm	PVC / stainless steel 316L / 1.4404	60 AC 60 DC	-25...100	IP 65 / IP 67 / IP 68 / IP 69K	–	6	EVT334



Connection technology

Type	Cable	Wire specification	Material housing / nut	U [V]	T _a [°C]	Protection	LEDs	Drawing no.	Order no.
Group 163 · Y connection cable , plug: M12, 4-pole, socket: M12, 5-pole, 5-wire, LED, PNP · Wiring diagram no. 6									
	1 m orange PVC cable	3 x 0.34 mm ² , Ø 4.9 mm	PVC / stainless steel 316L / 1.4404	10...36 DC	-25...100	IP 65 / IP 67 / IP 68 / IP 69K	green / yellow	7	EVT335
	2 m orange PVC cable	3 x 0.34 mm ² , Ø 4.9 mm	PVC / stainless steel 316L / 1.4404	10...36 DC	-25...100	IP 65 / IP 67 / IP 68 / IP 69K	green / yellow	7	EVT336
	5 m orange PVC cable	3 x 0.34 mm ² , Ø 4.9 mm	PVC / stainless steel 316L / 1.4404	10...36 DC	-25...100	IP 65 / IP 67 / IP 68 / IP 69K	green / yellow	7	EVT337

Connection cables for industrial applications



Type	Cable	Wire specification	Material housing / nut	U [V]	T _a [°C]	Protection	LEDs	Drawing no.	Order no.
Group 184 · Y connection cable , socket: Y, 6-pole, 6-wire · Wiring diagram no. 2									
	1 m black PUR cable	3 x 0.50 mm ² , Ø 5.4 mm	PA	12...24 DC	-40...80	IP 67	–	8	E12546
	2 m black PUR cable	3 x 0.50 mm ² , Ø 5.4 mm	PA	12...24 DC	-40...80	IP 67	–	8	E12547
	5 m black PUR cable	3 x 0.50 mm ² , Ø 5.4 mm	PA	12...24 DC	-40...80	IP 67	–	8	E12548
Group 186 · Y connection cable , socket: Y, 6-pole, 4-wire · Wiring diagram no. 3									
	1 m black PUR cable	2 x 2 x 0.50 mm ² , Ø 5.4 mm	PA	12...24 DC	-40...80	IP 67	–	8	E12552
	2 m black PUR cable	2 x 2 x 0.50 mm ² , Ø 5.4 mm	PA	12...24 DC	-40...80	IP 67	–	8	E12553
	5 m black PUR cable	2 x 2 x 0.50 mm ² , Ø 5.4 mm	PA	12...24 DC	-40...80	IP 67	–	8	E12554
Group 188 · Jumper , socket: Y/M12, 6/3-pole, 3-wire · Wiring diagram no. 4									
	1 m black PUR cable	3 x 0.50 mm ² , Ø 5.4 mm	PA / Brass	12...24 DC	-40...80	IP 67	–	9	E12558
	2 m black PUR cable	3 x 0.50 mm ² , Ø 5.4 mm	PA / Brass	12...24 DC	-40...80	IP 67	–	9	E12559

Type	Cable	Wire specification	Material housing / nut	U [V]	T _a [°C]	Protection	LEDs	Drawing no.	Order no.
------	-------	--------------------	------------------------	-------	---------------------	------------	------	-------------	-----------

Group 188 · Jumper , socket: Y/M12, 6/3-pole, 3-wire · Wiring diagram no. 4

	5 m black PUR cable	3 x 0.50 mm ² , Ø 5.4 mm	PA / Brass	12...24 DC	-40...80	IP 67	-	9	E12560
---	---------------------	-------------------------------------	------------	------------	----------	-------	---	---	---------------

Group 190 · Y connection cable , socket: Y/M12, 6/3-pole, 6-wire · Wiring diagram no. 5

	1 m black PUR cable	3 x 0.50 mm ² , Ø 5.4 mm	PA / Brass	12...24 DC	-40...80	IP 67	-	10	E12561
	2 m black PUR cable	3 x 0.50 mm ² , Ø 5.4 mm	PA / Brass	12...24 DC	-40...80	IP 67	-	10	E12562
	5 m black PUR cable	3 x 0.50 mm ² , Ø 5.4 mm	PA / Brass	12...24 DC	-40...80	IP 67	-	10	E12563

Wiring diagrams

Core colours

BK black
 BN brown
 RD red

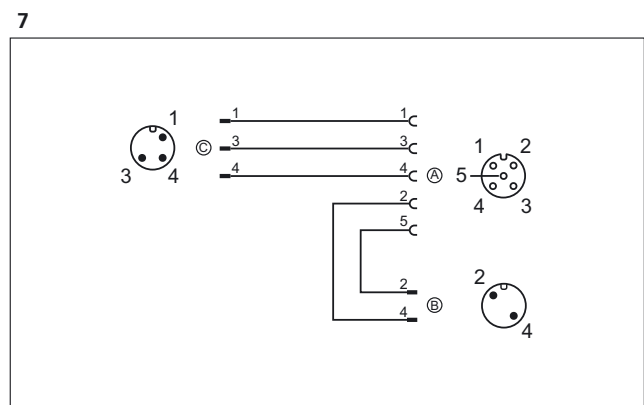
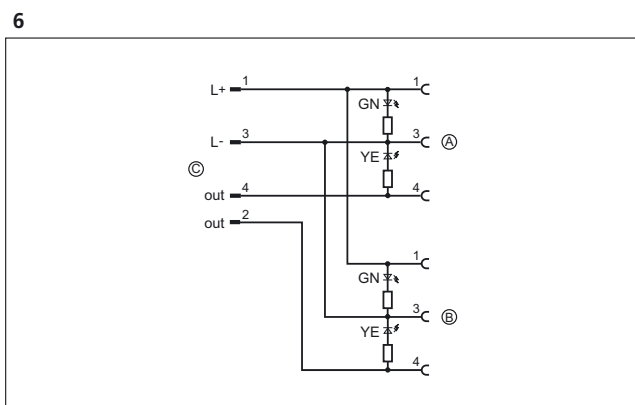
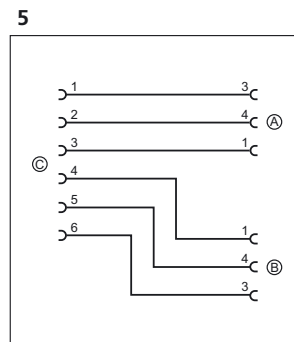
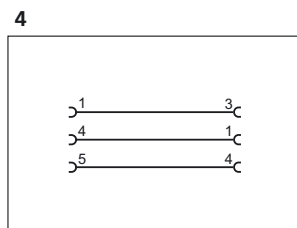
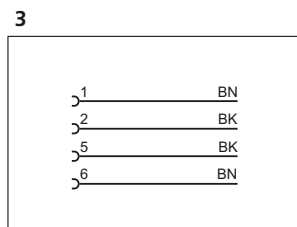
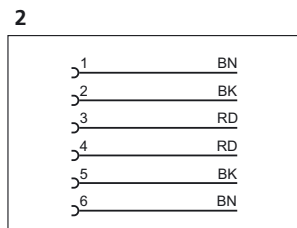
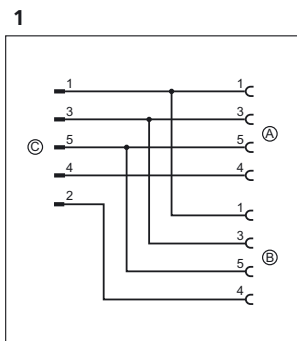



Scale drawings / drawing no. – CAD download: www.ifm.com

1

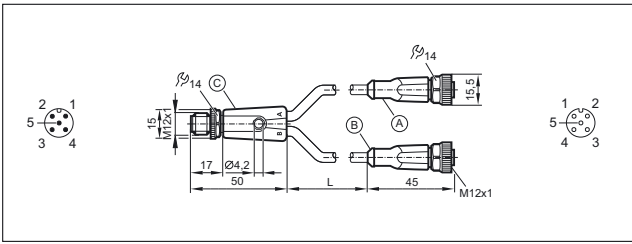

6

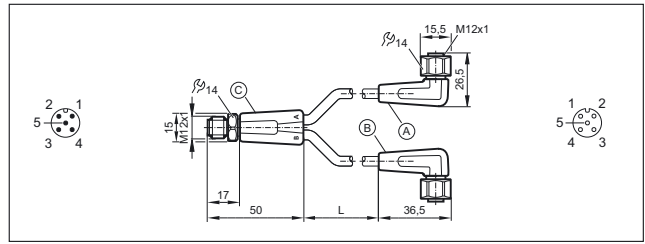

2

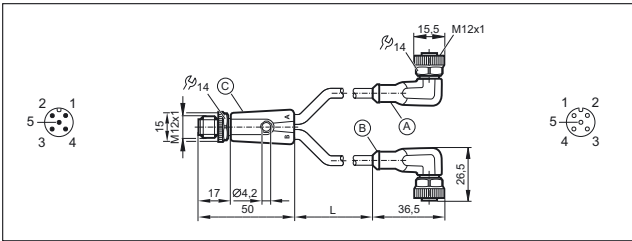

7

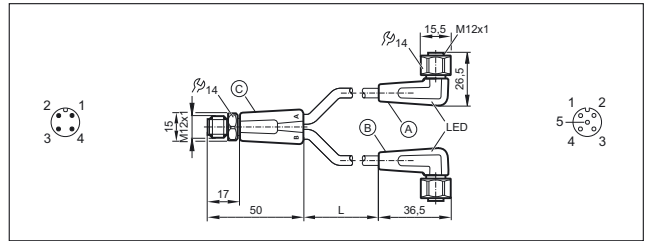

3

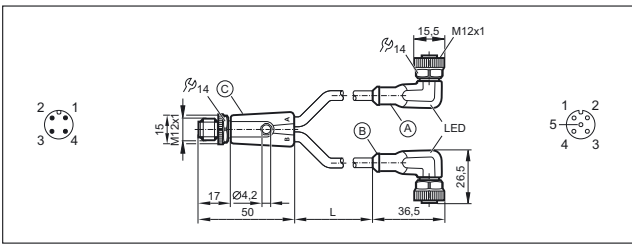

8

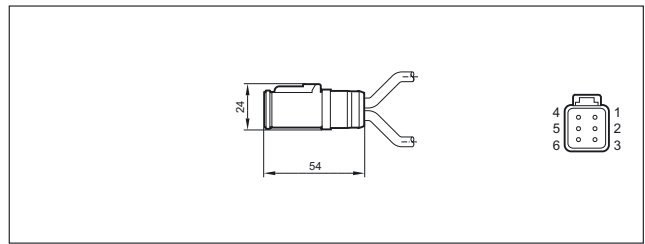

4

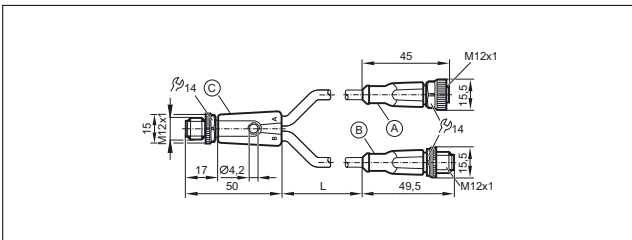

9

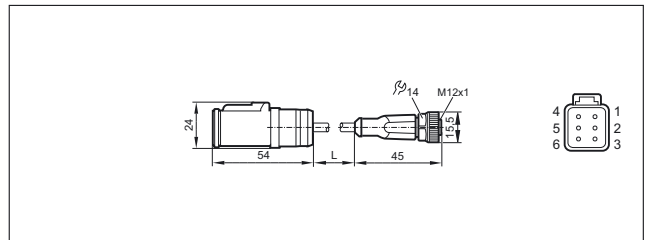

5

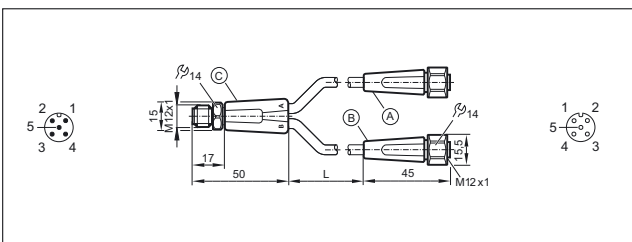

10

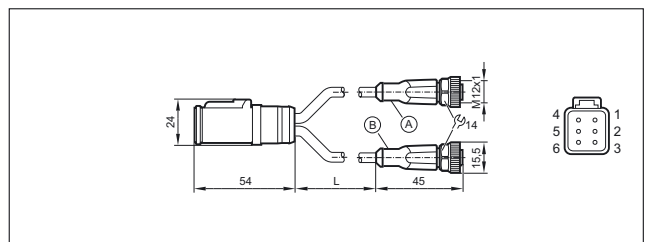





Switched-mode power supplies



Switched-mode power supplies

Primary switched-mode power supplies are a compact and economical solution to supply sensors and actuators. As opposed to conventional transformer power supplies with regulated output voltage, primary switched-mode power supplies need no heavy transformers so that there are fewer iron and copper losses. They are therefore distinguished by a very high degree of efficiency of up to 95 %. Due to the operating principle using high frequency transformers, switched-mode power supplies are much smaller and lighter than transformer power supplies that provide the same power. Nevertheless they ensure electrical separation. Moreover, they offer a wide standard input voltage range, e.g. 100...240 or 323...576 V AC. This makes them fit for worldwide use.

ifm switched-mode power supplies have a regulated output voltage of typ. 24 V DC with a tolerance of $\pm 2\%$. Apart from few exceptions, the output voltage can be set between 24 V and 28 V to compensate, for example, for a voltage drop on long cables. Between no load and full load they ensure a stable supply voltage and thus operational reliability in case of supply voltage fluctuations.

Power reserves

Switched-mode power supplies from ifm are rated for permanent operation in the specified performance limits. This allows the power supplies to be used at full load over almost the complete temperature range. Moreover they feature an excess gain of 20 % while reaching 100 % switch-on time.

Mains fluctuations and interference are compensated for. Even mains voltage dips of a few milliseconds are bridged while the output voltage is completely maintained.

An inrush current limitation actively reduces the peak inrush current and thus enables the use of common automatic circuit breakers.

The outputs are protected against short circuits and overload.



24 V DC power supplies

864 - 869



AS-i power supplies

870 - 872





Power supplies



24 V DC power supplies

These high-quality 24V switched-mode power supplies excel by their wide range of performance. Flexible one-phase or three-phase primary voltages with wide-range inputs can be used worldwide. Degrees of efficiency of up to 94 percent ensure that the control cabinet only heats up slightly. The units are protected against over-voltage and permanent short circuit.

System overview	Page
Power supplies / switching amplifiers with one output	864
Power supplies / switching amplifiers with 2 inputs and 2 outputs	864
Switched-mode power supplies, single phase, in compact plastic housing	865
Standard switched-mode power supplies, single phase, in robust metal housing	865
Standard switched-mode power supplies, two-phase, in robust metal housing	865
Standard switched-mode power supplies, three-phase, in robust metal housing	866
Accessories	866 - 867
Scale drawings / drawing no. – CAD download: www.ifm.com	867 - 869



Power supplies / switching amplifiers with one output

Type	Current [mA]	Output voltage [V]	Nominal voltage [V]	Output	Draw- ing no.	Order no.
	–	24 DC SELV, ± 10 %, 300 mA	110...240 AC	relay (1 changeover contact)	1	DN0210





Power supplies / switching amplifiers with 2 inputs and 2 outputs

Type	Current [mA]	Output voltage [V]	Nominal voltage [V]	Output	Draw- ing no.	Order no.
	–	24 DC SELV, ± 10 %, 2 x ≤ 150 mA	110...240 AC	2 relays (1 changeover contact per channel)	2	DN0220

Switched-mode power supplies, single phase, in compact plastic housing

Type	Current [A]	Output voltage [V]	Nominal voltage [V]	Mains buffering time [ms]	Efficiency typ. [%]	Drawing no.	Order no.
	1.25	24...28	115 / 230 AC	120 (230 V AC; 24 V DC; 1.25 A)	84	3	DN1030
	2.5	24...28	115 / 230 AC	90 (230 V AC; 24 V DC; 2.5 A)	88	3	DN1031
	4.1	24...28 DC (±2%)	115 / 230 AC	> 40 (230 V AC; 24 V DC / 4.1 A)	90	4	DN1022

Standard switched-mode power supplies, single phase, in robust metal housing

Type	Current [A]	Output voltage [V]	Nominal voltage [V]	Mains buffering time [ms]	Efficiency typ. [%]	Drawing no.	Order no.
	3.3	24...28 DC	115 / 230 AC	30 (120 V AC; 60 Hz) / 128 (230 V AC; 50 Hz)	88	5	DN4011
	5	24...28 DC	115 / 230 AC	80 (120 V AC; 60 Hz) / 78 (230 V AC; 50 Hz)	89.4	5	DN4012
	10	24...28 DC	115 / 230 AC	46 (120 V AC; 60 Hz) / 47 (230 V AC; 50 Hz)	91	6	DN4013
	20	24...28 DC	115 / 230 AC	26 (120 V AC; 60 Hz) / 26 (230 V AC; 50 Hz)	92.7	7	DN4014
	40	24...28 DC	115 / 230 AC	27 (120 V AC; 60 Hz) / 27 (230 V AC; 50 Hz)	93.6	8	E84016





Standard switched-mode power supplies, two-phase, in robust metal housing

Type	Current [A]	Output voltage [V]	Nominal voltage [V]	Mains buffering time [ms]	Efficiency typ. [%]	Drawing no.	Order no.
	5	24...28 DC	2 x 400 AC	27 (400 V AC; 50 Hz) / 48 (480 V AC; 60 Hz)	90.4	9	DN4032















Power supplies

Standard switched-mode power supplies, three-phase, in robust metal housing

Type	Current [A]	Output voltage [V]	Nominal voltage [V]	Mains buffering time [ms]	Efficiency typ. [%]	Drawing no.	Order no.
	10	24...28 DC	3 x 400 AC	34 (400 V AC; 50 Hz) / 54 (480 V AC; 60 Hz)	92.8	10	DN4033
	20	24...28 DC	3 x 400 AC	22 (400 V AC; 50 Hz) / 22 (480 V AC; 60 Hz)	95	11	DN4034
	30	24...28 DC (±2%)	3 x 400...500 AC	> 10	93	12	DN2036
	40	24...28 DC	3 x 400 AC	25 (400 V AC; 50 Hz) / 25 (480 V AC; 60 Hz)	95.3	13	E84036

Accessories

Type	Description	Order no.
	Supply module, standard · rail TH35 (to EN 60715) · Input current (max. total current) 40 A · for circuit protection modules DF12xx · Ambient temperature -25...60 °C · push-in terminals · contact lever/strip · Operating voltage 19.2...30 V DC · IP 20	DF1100
	Supply module, IO-Link · rail TH35 (to EN 60715) · Input current (max. total current) 40 A · for circuit protection modules DF22xx · Ambient temperature -25...60 °C · push-in terminals · contact lever/strip · Operating voltage 19.2...30 V DC · IP 20	DF2100
	Circuit protection module, standard · rail TH35 (to EN 60715) · Nominal current (Fail-safe element) 2 x 2 A · for supply module DF1100 · Ambient temperature -25...60 °C · push-in terminals · contact lever/strip · Operating voltage 19.2...30 V DC · IP 20	DF1212
	Circuit protection module, standard · rail TH35 (to EN 60715) · Nominal current (Fail-safe element) 2 x 4 A · for supply module DF1100 · Ambient temperature -25...60 °C · push-in terminals · contact lever/strip · Operating voltage 19.2...30 V DC · IP 20	DF1214
	Circuit protection module, standard · rail TH35 (to EN 60715) · Nominal current (Fail-safe element) 2 x 6 A · for supply module DF1100 · Ambient temperature -25...60 °C · push-in terminals · contact lever/strip · Operating voltage 19.2...30 V DC · IP 20	DF1216
	Circuit protection module, standard · rail TH35 (to EN 60715) · Nominal current (Fail-safe element) 1 x 8 A · for supply module DF1100 · Ambient temperature -25...60 °C · push-in terminals · contact lever/strip · Operating voltage 18...30 V DC · IP 20	DF1208
	Circuit protection module, standard · rail TH35 (to EN 60715) · Nominal current (Fail-safe element) 1 x 10 A · for supply module DF1100 · Ambient temperature -25...60 °C · push-in terminals · contact lever/strip · Operating voltage 18...30 V DC · IP 20	DF1210
	Circuit protection module, IO-Link · rail TH35 (to EN 60715) · Nominal current (Fail-safe element) 2 x 2 A · for supply module DF2100 · Ambient temperature -25...60 °C · push-in terminals · contact lever/strip · Operating voltage 19.2...30 V DC · IP 20	DF2212
	Circuit protection module, IO-Link · rail TH35 (to EN 60715) · Nominal current (Fail-safe element) 2 x 4 A · for supply module DF2100 · Ambient temperature -25...60 °C · push-in terminals · contact lever/strip · Operating voltage 19.2...30 V DC · IP 20	DF2214

Type	Description	Order no.
	Circuit protection module, IO-Link · rail TH35 (to EN 60715) · Nominal current (Fail-safe element) 2 x 6 A · for supply module DF2100 · Ambient temperature -25...60 °C · push-in terminals · contact lever/strip · Operating voltage 19.2...30 V DC · IP 20	DF2216
	Circuit protection module, IO-Link · rail TH35 (to EN 60715) · Nominal current (Fail-safe element) 1 x 8 A · for supply module DF2100 · Ambient temperature -25...60 °C · push-in terminals · contact lever/strip · Operating voltage 18...30 V DC · IP 20	DF2208
	Circuit protection module, IO-Link · rail TH35 (to EN 60715) · Nominal current (Fail-safe element) 1 x 10 A · for supply module DF2100 · Ambient temperature -25...60 °C · push-in terminals · contact lever/strip · Operating voltage 18...30 V DC · IP 20	DF2210

Scale drawings / drawing no. – CAD download: www.ifm.com

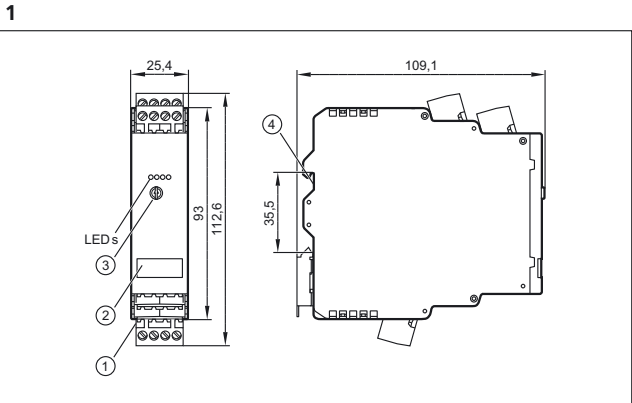

1: plug-in screw terminals, 2: label, 3: potentiometer, 4: Mounting on DIN rail

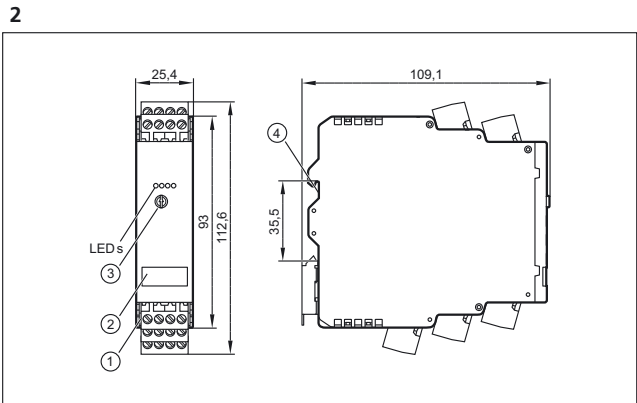

1: plug-in screw terminals, 2: label, 3: potentiometer, 4: Mounting on DIN rail

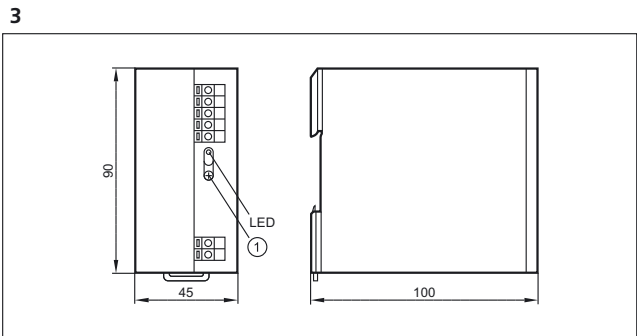

1: potentiometer

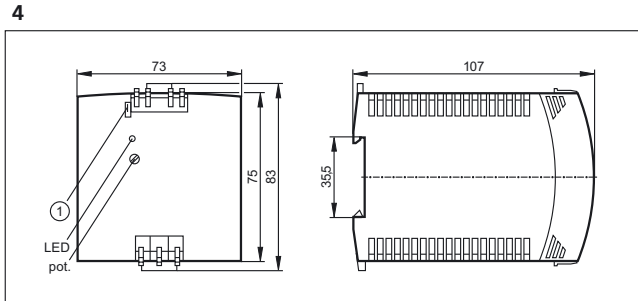

1: Jumper "single/parallel operation"

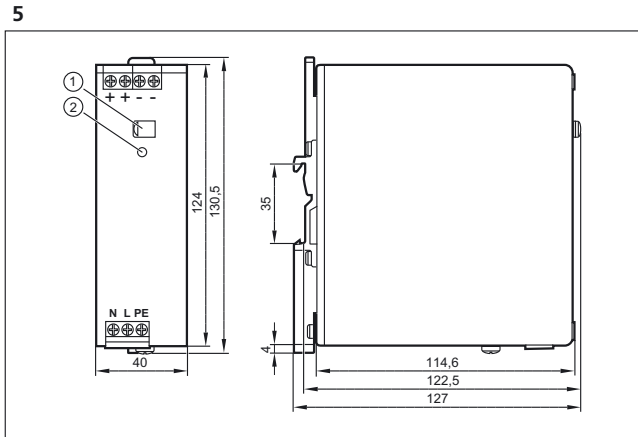

1: Potentiometer 24...28 V DC, 2: LED DC ok

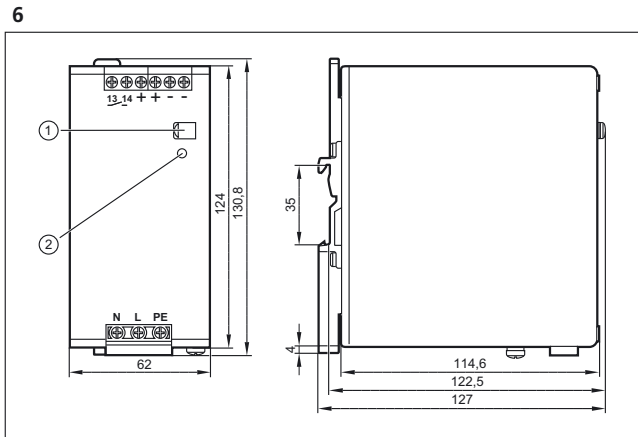

1: Potentiometer 24...28 V DC, 2: LED DC ok



Power supplies

Scale drawings / drawing no. – CAD download: www.ifm.com

7

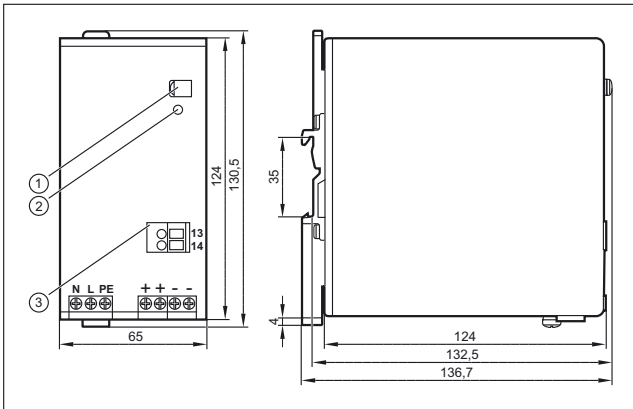

1: Potentiometer 24...28 V DC, 2: LED DC ok, 3: Terminals DC OK signal

10

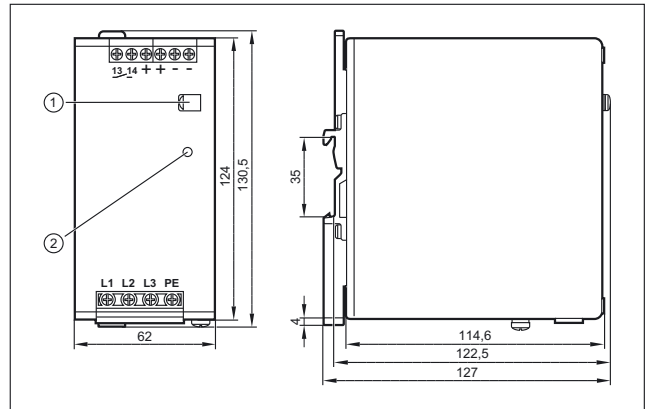

1: Potentiometer 24...28 V DC, 2: LED DC ok

8

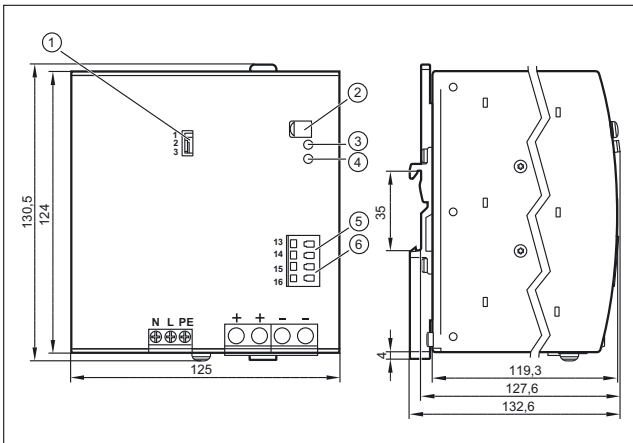

1: Jumper "single/parallel operation", 2: Potentiometer 24...28 V DC, 3: LED DC ok, 4: LED Overload, 5: Terminals DC OK signal, 6: Terminals shut down input

11

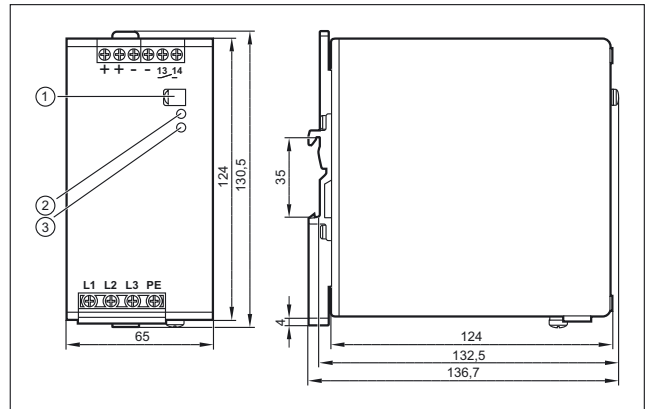

1: Potentiometer 24...28 V DC, 2: LED DC ok, 3: LED Overload

9

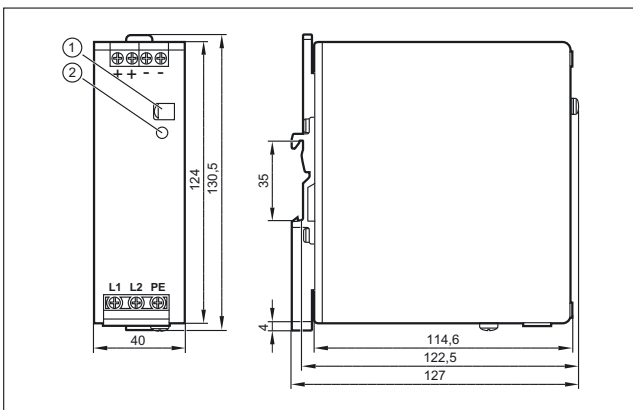

1: Potentiometer 24...28 V DC, 2: LED DC ok

12

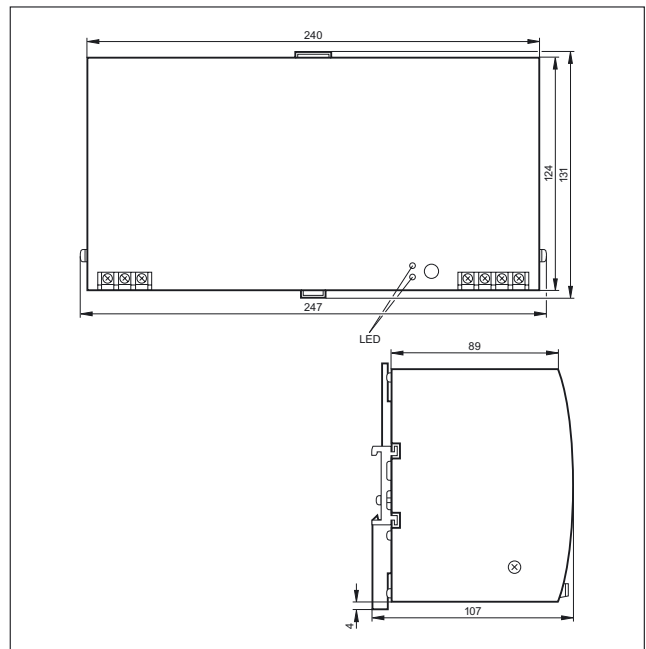

Scale drawings / drawing no. – CAD download: www.ifm.com

13

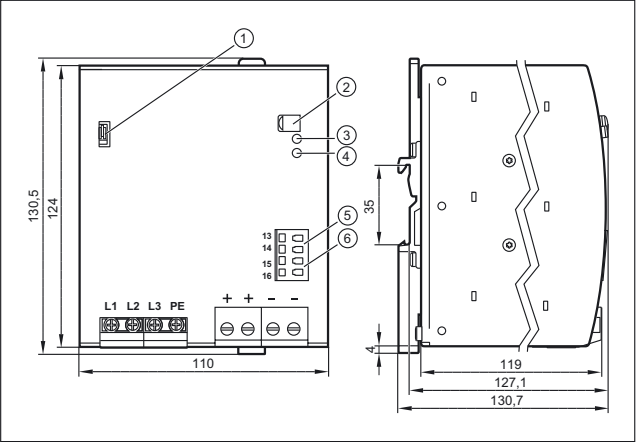

1: Jumper "single/parallel operation", 2: Potentiometer 24...28 V DC, 3: LED DC ok, 4: LED Overload, 5: Terminals DC OK signal, 6: Terminals shut down input





Power supplies





AS-i power supplies

All AS-i power supplies are primary switched-mode power supplies with a high degree of efficiency. The robust DIN rail housing can be easily integrated in large control cabinets as well as in local boxes. The primary voltage range stretches from 24 V DC via 230 V AC up to 400 V AC three-phase and can consequently be adapted to the local conditions.

System overview	Page
AS-i switched-mode power supplies, single phase, in robust metal housing	870
AS-i switched-mode power supplies, single phase, in compact plastic housing	870
AS-i switched-mode power supplies, three -phase, in robust metal housing	871
DC / DC converter (24 V / AS-i), in robust metal housing	871
Scale drawings / drawing no. – CAD download: www.ifm.com	871 - 872

AS-i switched-mode power supplies, single phase, in robust metal housing

Type	Current [A]	Output voltage [V]	Nominal voltage [V]	Mains buffering time [ms]	Efficiency typ. [%]	Draw- ing no.	Order no.
	2.8	30.5 DC	115 / 230 AC	98 (120 V AC; 60 Hz) / 96 (230 V AC; 50 Hz)	86.9	1	AC1256
	4	30.5 DC	115 / 230 AC	70 (120 V AC; 60 Hz) / 70 (230 V AC; 50 Hz)	88	1	AC1254
	8	30.5 DC	115 / 230 AC	44 (120 V AC; 60 Hz) / 42 (230 V AC; 50 Hz)	89.4	2	AC1258

AS-i switched-mode power supplies, single phase, in compact plastic housing

Type	Current [A]	Output voltage [V]	Nominal voltage [V]	Mains buffering time [ms]	Efficiency typ. [%]	Draw- ing no.	Order no.
	1.9	29.5...31.6 DC	100...240 AC	90 (230 V AC)	88	3	AC1221

AS-i switched-mode power supplies, three -phase, in robust metal housing

Type	Current [A]	Output voltage [V]	Nominal voltage [V]	Mains buffering time [ms]	Efficiency typ. [%]	Drawing no.	Order no.
	8	30.5 DC	3 x 400 AC	34 (400 V AC; 50 Hz) / 53 (480 V AC; 60 Hz)	92	4	AC1253

DC / DC converter (24 V / AS-i), in robust metal housing

Type	Current [A]	Output voltage [V]	Nominal voltage [V]	Mains buffering time [ms]	Efficiency typ. [%]	Drawing no.	Order no.
	4	30.5 DC	24 DC	6 (24 V DC)	90.5	5	AC1257

Scale drawings / drawing no. – CAD download: www.ifm.com

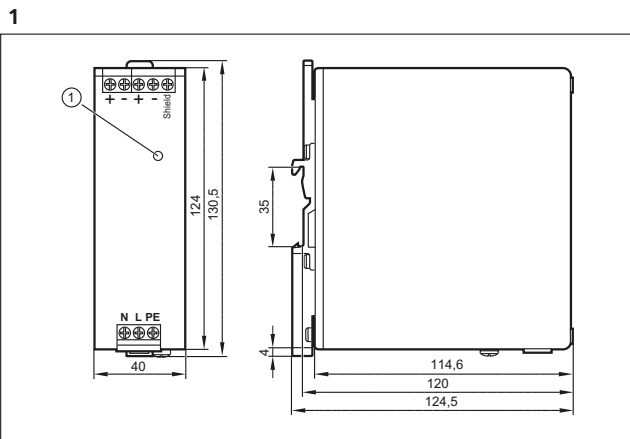

1: LED AS-i ok

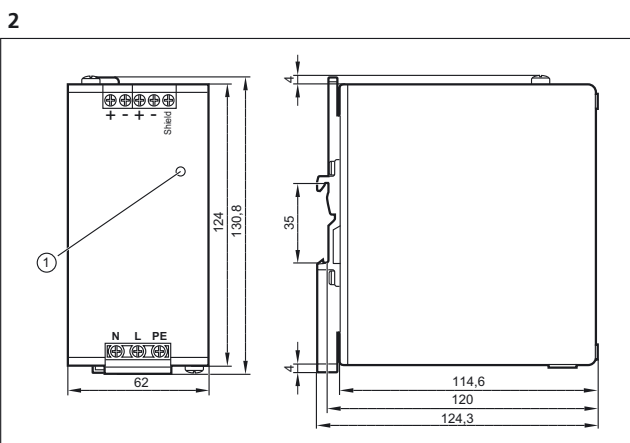

1: LED AS-i ok

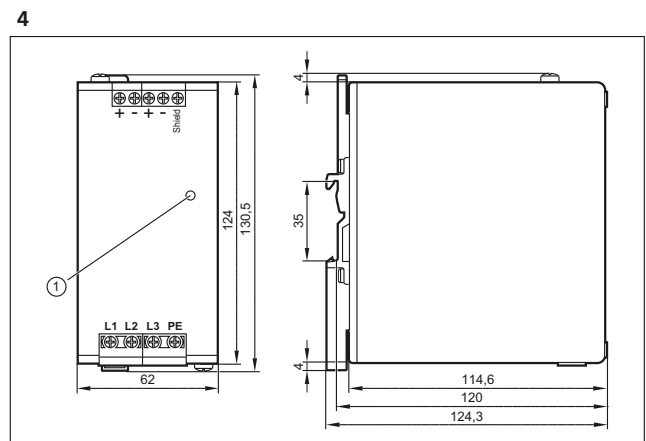
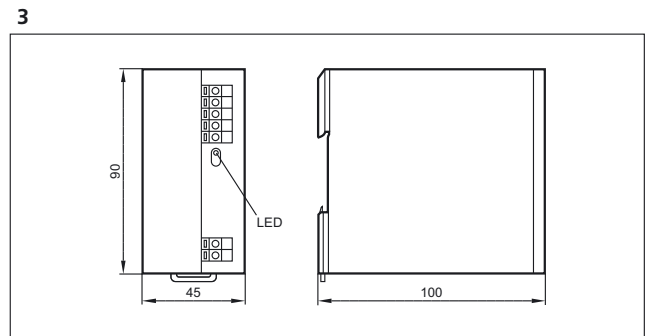

1: LED AS-i ok



Power supplies

Scale drawings / drawing no. – CAD download: www.ifm.com

5

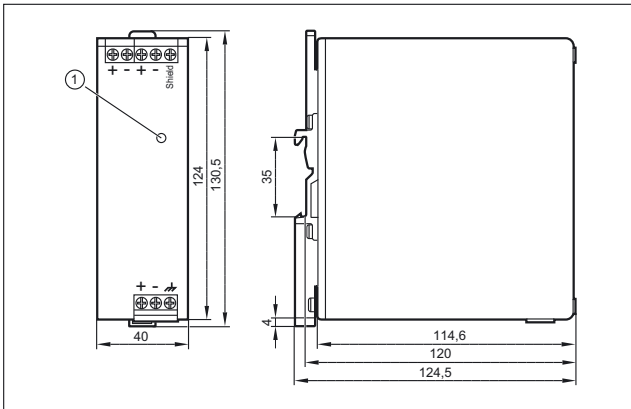

1: LED AS-i ok



Algeria

**Sarl AMS Algérie – Automatismes
Motorisation & Services**
Lotissement C, lot n°190 B
16000 Draria
Tel. +213 5 59 43 45 22
Tel. +213 23 26 41 45
Fax +213 21 35 44 21
contact@amsalgerie.com
www.amsalgerie.com

Argentina

ifm electronic s.r.l.
Lola Mora 421
10° piso, oficina 3
1107 - Puerto Madero
Ciudad Aut. Buenos Aires
Tel./Fax +54 (011) 5353-3436
Interior del país: 0810-345-3436
info.ar@ifm.com
www.ifm.com/ar

Armenia

Industrial Components LLC
28/15, Artsakh Street
0041 Yerevan
Tel. +374 10 450035
Fax +374 10 450035
icomponents@bk.ru

Australia

ifm efector pty ltd.
PO Box 479
Suite 3, 745 Springvale Road
Mulgrave VIC 3170
Tel. 1300 365 088
Fax 1300 365 070
sales.au@ifm.com
www.ifm.com/au

Austria

ifm electronic gmbh
Wienerbergstraße 41
Gebäude E
1120 Vienna
Tel. +43 / 1 / 617 45 00
Fax +43 / 1 / 617 45 00 10
info.at@ifm.com
www.ifm.com/at

Bangladesh

Sensotec Automation and Control
5, New Eskaton Road
Ghausnagar, Ramna
1000 Dhaka
Tel. +880 171 154 689 0
Fax +880 293 300 93
sensotec@agni.com

Belgium and Luxembourg

ifm electronic n.v./s.a.
Zuiderlaan 91 - B6
1731 Zellik
Tel. +32 2 481 0220
Fax +32 2 463 1795
info.be@ifm.com
www.ifm.com/be

Bolivia

BAVARIA SRL
C. Mario Diaz de medina (26-A), n° 32
Zona Calacoto Alto, Urb. Morocollo –
Santos Pariamo
La Paz
Tel. +591 2 279 269 1
Mobile +591 720 47 442
alvarobaptista@bavaria.bo
www.bavaria.bo

Brazil

ifm electronic Ltda.
Rua Eleonora Cintra, 140
Jardim Analia Franco
03337-000 São Paulo
Tel. +55-11-2672-1730
Fax +55-11-2673-3501
info.br@ifm.com
www.ifm.com/br

Bulgaria

ifm electronic eood
1202 Sofia
ul. Klokochnica No 2A
Business Centre IVEL
fl.4, office 17
Tel. +359 2 807 59 69
Fax +359 2 807 59 60
info.bg@ifm.com

Cameroon

TSI
Rue Njoh
BP 3301
Face Clé des Chateaux
Douala
Tel. +237 9691 1865

SOFIPAC

Bonapriso suite à la Rue des Palmiers
3724 Douala
Tel. +237 96911865
info@sofipacsarl.com
www.sofipacsarl.com

Canada

ifm efector Canada Inc.
2233 Argenta Road, Suite 104
Mississauga, ON L5N 2X7
Tel. 855-436-2262
Fax 855-399-5099
info.ca@ifm.com
www.ifm.com/ca

Chile

ifm electronic SpA
Presidente Eduardo Frei Montalva
6199,
Oficina 5041
Comuna de Conchalí
Región Metropolitana
Tel.: +56-2-32239282
info.cl@ifm.com

China

ifm electronic (Shanghai) Co., Ltd
Building 15,
No. 1000, Zhangheng Road,
Pu Dong District.
201203 Shanghai, P.R.China
Tel. +86 21 3813 4800
Fax +86 21 5027 8669
400 National Service Hotline:
400 880 6651
info.cn@ifm.com
www.ifm.com/cn

ifm electronic (HK) Ltd

Unit 2106, 21/F,
Tower 2, Metroplaza
No. 223 Hing Fong Road,
Kwai Chung,
N.T., Hong Kong.
info.hk@ifm.com
www.ifm.com/hk

ifm electronic (Taiwan) Limited

9F.-6, No.12, Fuxing 4th Rd., Cianjhen
District, Kaohsiung City,
Postal Code 806, Taiwan, R.O.C.
Tel. +886-7-335-7778
Fax +886-7-335-6878
info.tw@ifm.com
www.ifm.com/tw

Colombia

SENSOMATIC SAS
Calle 1 F 25a – 50
Bogotá D.C.
Tel. +57 124 741 74
Fax +57 121 367 53
info@sensomatic-ltda.com
www.sensomatic-ltda.com

Costa Rica

Genbus SA
Santa Rosa, Sto. Domingo, Heredia.
Bodegas Del Sol, Bodega n° 22
Tel. +506 25 60 39 58
Tel. +506 22 62 39 27
info@genbuscr.com
www.genbuscr.com

Croatia

ifm electronic gmbh
Wienerbergstr. 41
Gebäude E
1120 Wien
Tel. +43 / 1 / 617 45 00
Fax +43 / 1 / 617 45 00 10
info.hr@ifm.com
www.ifm.com/hr

Czech Republic

ifm electronic, spol. s r.o.
GreenLine Kačerov
Jihlavská 1558/21
140 00 Praha 4 – Michle
Tel. +420 267 990 211
Fax +420 267 750 180
info.cz@ifm.com
www.ifm.com/cz

Denmark

ifm electronic a/s
Ringager 4A
2605 Brøndby
Tel. +45 70 20 11 08
info.dk@ifm.com
www.ifm.com/dk

Dominican Republic

Ilumeyco Soluciones
Av Sabana Larga No. 160
Reparto Oquet
Santiago
Tel. +1809 5834255
info@ilumeyco.com
www.ilumeyco.com

Ecuador

ECUAINSETEC
Yugoslavia N34-110 Y Azuay
Quito
Tel. +593 2 2450475
infoouio@ecuainsetec.com.ec
www.ecuainsetec.com.ec

Egypt

**Egyptian Establishment for
Electromechanical Supplies Co.**
27 Elsalam Street
Haram Street, Near to Three Pyramids
Hotel Giza
Tel. +20 2 27298238
Fax +20 2 27298239
Mobile +20 1001061791
info@3ESsupplies.com
www.3ESsupplies.com

El Salvador

Provinter
Prolongación Boulevard Constitución,
Residencial La Gloria, Block C-3 pje. 2-C
N°1 Mejicanos
San Salvador
Tel. +503 25643005
www.provintersv.com

Estonia

Pesmel Estonia Ltd.
Segu 4
76505 Saue
Tel. +372 674 73 30
Fax +372 674 73 31
pesmel@pesmel.ee
www.pesmel.ee

Finland

ifm electronic oy
Vaakatie 5
00440 Helsinki
Tel. +358 (0)75 329 5000
Fax +358 (0)75 329 5010
info.fi@ifm.com
www.ifm.com/fin

France

ifm electronic
Siège :
Savoie Technolac BP226
73374 Le Bourget du Lac
Agence commerciale :
Immeuble Uranus
1-3 rue Jean Richepin
93192 NOISY LE GRAND CEDEX
Tel. 0820 22 30 01
Fax 0820 22 22 04
info.fr@ifm.com
www.ifm.com/fr

Germany

ifm electronic gmbh
Friedrichstr. 1
45128 Essen
Tel. +49 201 24 22 0
Fax +49 201 24 22 12 00
info@ifm.com
www.ifm.com/de

Greece

ifm electronic monoprosofi E.P.E.
27, Andrea Papandreou Street
15125 Amaroussi
Tel. +30 210 61 800 90
Fax +30 210 61 994 00
info.gr@ifm.com
www.ifm.com/gr

Guatemala

**IASA Ingenieros Civiles
Electromecánicos Asociados, SA**
20 Calle 25-55 Zona 12
Empresarial El Cortijo 3 of 907
99999 Guatemala City
Tel. +502-23061300
info@iasa.com.gt
www.iasa.com.gt

Honduras

RyD INDUSTRIAL
Bo. Paz Barahona
14 Y 15 Calle 11 Ave.
San Pedro Sula #142
Tel. +504 5503703
Fax +504 5501108
ventas@rydindustrial.com
www.rydindustrial.com

Hungary

ifm electronic kft.
Szent Imre út 59. I.em.
H-9028 Győr
Tel. +36-96 / 518-397
Fax +36-96 / 518-398
info.hu@ifm.com
www.ifm.com/hu

India

ifm electronic India Private Limited
Plot No. P-39/1
MIDC Gokul Shirgaon
Kolhapur – 416234
Maharashtra State
Tel. +91 / 231 / 267 27 70
Fax +91 / 231 / 267 23 88
info.india@ifm.com
www.ifm.com/in

Indonesia

PT. Indoserako Sejahtera
Jl. P. Jayakarta 121 No. 59
10730 Jakarta Pusat
Tel. +62 21 6 24 8923
Fax +62 21 6 24 8922
iso297@dnet.net.id
www.indoserako.com

Ireland

ifm electronic (Ireland) Ltd.
No. 7, The Courtyard
Kilcarbery Business Park
New Nangor Road
Clondalkin
Dublin 22
Tel. +353 / 1 / 461 32 00
Fax +353 / 1 / 457 38 28
sales_ie@ifm.com
www.ifm.com/ie

Israel

Astragal Ltd.
14 Atir Yeda St.
PO Box 6004
4464323 Kfar Saba
Tel. +972 3 5 59 16 60
Fax +972 3 5 59 23 40
astragal@astragal.co.il
www.astragal.co.il

Italy

ifm electronic
Centro Direzionale Colleoni
Palazzo Andromeda 2
Via Paracelso n. 18
20864 Agrate Brianza (MB)
Tel. +39 (0)39-6899982
Fax +39 (0)39-6899995
info.it@ifm.com
www.ifm.com/it

Ivory Coast

DM Company
Marcory Hibiscus
Rue Boulevard du Gabon, Villa 270
1381 Abidjan 13
Tel. +225 21 28 04 72
Fax +225 21 28 04 18
info@dmc-ci.com
www.dmc-ci.com

Japan

ifm efector co. ltd.
18F WBG Marive-west
2-6-1 Nakase, Mihama-ku
Chiba-shi, Chiba 261-7118
info.jp@ifm.com
www.ifm.com/jp

Jordan

**Technical Center For
Industrial Services.**
Broadcasting Street
Building # 48
PO Box: 110130 Amman 11110
Jordan
Mohannad Sha'ban
Training & Technical Support Engineer
Email m.shaban@tec-jo.com
Tel. +962 6 4739112
Mobile +962 79 9490149
Fax +962 6 4789611

Al Mashreqan Trading Supplies Co.

Otbah ben gazwan.
Modern Business Building 1st floor
Amman
Tel. +962 65540844
Fax +962 65540846
info@mashreqan.com
www.mashreqan.com

Kenia

Thames Electricals Ltd.
Sasio Road, off Lunga Road
PO Box 10403-00400
Nairobi
Tel. +254 20533276
Fax +254 20533883
Inl@africaonline.co.ke

Korea

ifm electronic Ltd.
Hyundai Liberty House 201
Dokseodang-ro Yongsan-Gu
04420 Seoul
Tel. +82 2-790-5610
Fax +82 2-790-5613
info.kr@ifm.com
www.ifm.com/kr

Kuwait

**Kana Controls General Trading &
Contracting Co.**
Avenues Mall, 5th block
Al-Rai, 5th Ring Road
Between Ghazali Street & Mohammed
Bin Alqasem Street
13052 Kuwait City
Tel. +965 24741373
info@kanacontrols.com
www.kanacontrols.com

Latvia

EC Systems
Katlakalna 4a
1073 Riga
Tel. +371 672 41231
Fax +371 672 48478
www.ecsystems.lv

Lebanon

**MEDEVCO Middle East
Development Co. SAL**
PO Box 67
9999999 Jounieh
Tel. +961 9 233550
Fax +961 9 233553
info@medevco-lebanon.com

Lithuania

Elinta UAB
Terminalo Str. 3, Biruliskes
54469 Kaunas district
Tel. +370 37 351 987
Fax +370 37 452 780
info@elinta.lt
www.elinta.lt

Malaysia & Singapore

ifm electronic Pte Ltd
25 International Business Park
#03-26/29 German Centre
609916 Singapore
Tel. +6565628661
Fax +6565628660
sales.sg@ifm.com
www.ifm.com/sg

Malaysian Branch Office

No. 9F – 2A, 9th Floor,
Tower 4 @ PFCC, Jalan Puteri 1/2,
Bandar Puteri Puchong,
47100 Puchong, Selangor
Tel. + 603 8066 9853
Fax + 603 8066 9854
sales.my@ifm.com
www.ifm.com/my

Martinique

EMPH
Immeuble Seen
Zone industrielle La Lezarde
97232 Le Lamentin
Tel. +33 596 513154
Fax +33 596 570845
contact@emph-mq.com
www.emph-martinique.com

Mexico

ifm efector S. de R.L. de C.V.
Ave. Arq. Pedro Ramirez Vázquez 200-4
Planta Baja, Col. Valle Oriente,
San Pedro Garza García, N.L. 66269
Tel. +52-81-8040-3535
Fax +52-81-8040-2343
clientes.mx@ifm.com
www.ifm.com/mx

Morocco

SOFIMED
137 Boulevard Moulay Ismail, Roches
Noires
20290 Casablanca
Tel. +212 522 240 101
www.sofimedmaroc.com

Namibia

ifm electronic (pty) Ltd
1 Basement Office,
Decor House
25 Dr. W. Kulz Street
Windhoek
Namibia
Tel. +264 61 300984 / 300998
Fax +264 61 300910
Fax to email +264 88 651 9943
info.na@ifm.com
www.ifm.com/na

Netherlands

ifm electronic b.v.
Deventerweg 1 E
3843 GA Harderwijk
Tel. +31 / 341 438 438
Fax +31 / 341 438 430
info.nl@ifm.com
www.ifm.com/nl

New Zealand

ifm efector pty ltd.
Unit 13, 930 Great South Road
Penrose, Auckland
Tel. +64 / 95 79 69 91
Fax +64 / 95 79 92 82
sales.nz@ifm.com
www.ifm.com/nz

Nigeria

Automated Process Ltd.
3rd Floor, 32 Lagos Abeokuta
Expressway
Near Cement Bus Stop
Dopemu, Agege
Lagos
Tel. +234 1 4729 967
Fax +234 1 4925 865
sales@automated-process.com
www.automated-process.com

Norway

JFKnudtzen AS
Billingstadsletta 97
1396 Billingstad
Postboks 160
1378 Nesbru
Tel. +47 66 98 33 50
Fax +47 66 98 09 55
firmapost@jfknudtzen.no
www.jfknudtzen.no

Oman

**TEC Technical Engineering
Comp. LLC**
PO Box 59
Madinat Al Sultan Qaboos
115 Muscat
Tel. +968 24591670
Fax +968 2451700
tecoman@omantel.net.om

Panama

JyD
Golden Point Tower Office: 15-07
Via Ricardo J. Alfaro, Ciudad de
Panamá
Tel. +507 3030216
Tel. +507 3030217
Mobile +507 62004205
jaguilar@jdaingenieria.com
www.jdaingenieria.com

Peru

ACME
Av. Andres Tinoco 133
Lima, Surco
Tel. +51 990556005
acmecia@acmecia.com
www.acmecia.com

Philippines

iProcess Controls Trading INC.
Unit 303 Tower B Almanza Metropolis
Condominium Manila Doctors Village,
Almanza Las Pinas City
Tel. +63 27722309
Fax +63 25875990

Gram Industrial Inc.
Bldg. 9 Don Mariano Lim
Industrial Complex
Alabang Zapote Road
Corner Concha Cruz Drive, Barangay
Almanza 1
1740 La Pinas City,
Tel. +63 2 850 2218
Fax +63 2 807 7173
efector@gram.com.ph
www.gram.com.ph

Poland

ifm electronic Sp.z o.o.
ul. Węglowa 7
PL 40-105 Katowice
Tel. +48 32 70 56 454
Tel. +48 32 70 56 480
Fax +48 32 70 56 455
info.pl@ifm.com
www.ifm.com/pl

Portugal

ifm electronic s.a.
Parque Tecnológico S. Félix da Marinha
Avenida Manuel Violas, 476
4410-137 São Félix da Marinha
Tel. +351 22 37 17 108
Fax +351 22 37 17 110
info.pt@ifm.com
www.ifm.com/pt

Qatar

Advanced Fluid Power
PO Box 201382
Building No. 01
Shop No. 36 & 37
Barwa Village Al Wakra
Doha
Tel. +974 40164273
Tel. +974 40164275
Fax +974 40164274
sales@afp-qatar.com
www.afp-qatar.com

Réunion

Diffusion Instrumentations
21 rue de la Martinique
ZA Foucherolles-Sainte-Clotilde
Tel. +262 216870
diffusion.instrum@laposte.net

Romania

ifm electronic s.r.l.
Mihai Viteazu Str. Nr. 1
Selimbar, Sibiu
557260
Tel. 0040 269 224550
Fax 0040 269 224766
info.ro@ifm.com

Russia

ifm electronic
Ibragimova, 31, k.50
office 808
105318 Moscow
Tel. +7 (495) 921-44-14
Fax +7 (495) 651-82-97
info.ru@ifm.com
www.ifm.com/ru

Saudi Arabia

**Noor Al-Shomoe for Electric &
Maintenance**
King Khalid Street, Cross 5
PO Box 2571
31952 Al-Khobar
Tel. +966 38939418
Fax +966 38946341
h.o.info@nooralshomoe.com

Bariq Trading Establishment

PO Box 27001
11417 Riyadh
Tel. +966 14728782
Fax +966 14725576
info@bariqarabia.com
www.bariqarabia.com

Slovakia

ifm electronic spol. s.r.o.
Rybnicna 40
831 06 Bratislava
Tel. +421 / 2 / 44 87 23 29
Fax +421 / 2 / 44 64 60 42
info.sk@ifm.com
www.ifm.com/sk

South Africa

ifm electronic (pty) Ltd
112 Sovereign Drive,
Route 21 Corporate Park
Centurion
0157
Postnet Suite 279
Postnet Bag X8
Elardus Park
0047
National 0861 IFM RSA (436 772)
International +72 12 450 0400
Fax +27 12 450 0412
info.za@ifm.com
www.ifm.com/za

Spain

ifm electronic s.l.
Parc Mas Blau
Edificio Inbisa
c/ Garrotxa 6-8
08820 El Prat de Llobregat
Tel. 0034 93 479 30 80
Fax 0034 93 479 30 86
info.es@ifm.com
www.ifm.com/es

Sweden

ifm electronic ab
Drakegatan 6
41250 Gothenburg
Tel. växel 031-750 23 00
Fax 031-750 23 29
info.se@ifm.com
www.ifm.com/se

Switzerland

ifm electronic ag
Altgraben 27
4624 Härkingen
Tel. 0800 88 80 33
Fax 0800 88 80 39
info.ch@ifm.com
www.ifm.com/ch

Thailand

SCM Alliances Co. Ltd.
700/19-24
Phaholyothin Road
Samsennai Phayatai
10400 Bangkok
Tel. +66 2 615 4888
Fax +66 2 615 4644
contact@scma.co.th
www.scma.co.th
www.ifm-thailand.com

Tunesia

TECHNOPREST
90, Avenue de Carthage Appt. A33
1000 Tunis
Tel. +216 71 385 355
Tel. +216 71 389 203
Fax +216 71 389 215
www.technoprest.com.tn

Turkey

**ifm electronic Elektrikli
ve Elektronik Aletler
İth.İhr.Paz.Tic.Ltd.Şti.**
Merkez Mah. Nadide Sok.
Anıttepe Sitesi No:28
34381 Şişli / İstanbul
Tel. +90 / 212 / 210 5080
Fax +90 / 212 / 221 7159
info.tr@ifm.com
www.ifm.com/tr

Ukraine

ifm electronic
Mariny Raskovoj 11
02002 Kiev
Tel. +380 44 501 8543
Fax +380 44 501 8543
info.ua@ifm.com
www.ifm.com/ua

United Arab Emirates

**Al Itqan Factory Equipment
Trading LLC**
PO Box 92924
Dubai
Tel. +971 42673838
Fax +971 42672300
aifeqtrd@eim.ae
www.itqanuae.com

Al Injazat Technical Services (ATS)

PO Box 42895
Al Hamed Tower Building
3rd floor Flat #105
Al Falah Street
Abu Dhabi
Tel. +971 26226030
Fax +971 26223050
www.injazat.ae

United Kingdom

ifm electronic Ltd.
efector House
Kingsway Business Park
Oldfield Road
Hampton
Middlesex TW12 2HD
Tel. +44 / 20 / 8213 0000
Fax +44 / 20 / 8213 0001
enquiry_gb@ifm.com
www.ifm.com/uk

Uruguay

Temac SA
Isabela 3264
Montevideo
Tel. +598 22188017
ventas@temac.com.uy
www.temac.com.uy

USA

ifm efector, inc.
1100 Atwater Dr.
Malvern, PA 19355
Tel. +1-800-441-8246
Fax +1-800-329-0436
info.us@ifm.com
www.ifm.com/us

Venezuela

Petrobornas CA
CC Plaza Aeropuerto
Calle Neveri
Piso 1 Local 3 Unare
25300 Puerto Ordaz
Tel. +58 286 9513382
info@petrobornas.net
petrobornas.net

Vietnam

ifm electronic Vietnam Co., Ltd.
Room 401, 4th Floor,
HD Tower,
25 Bis Nguyen Thi Minh Khai Street,
Ben Nghe Ward, District 1
700000 Ho Chi Minh City
Vietnam
Tel. +84-28-2253.6715
Fax +84-28-2253.6716
sales.vn@ifm.com

ifm – close to you!

visit our website:

www.ifm.com

Over 70 locations worldwide – at a glance at www.ifm.com



ifm electronic gmbh
Friedrichstraße 1
45128 Essen
Tel. +49 / 201 / 24 22-0
Fax +49 / 201 / 24 22-1200
E-Mail: info@ifm.com





ifm – close to you!