



ifm
ifm
ifm
ifm
ifm
ifm

NEWSBOOK 2018

innovation
innovation
innovation
innovation
innovation
innovation
innovation
innovation
innovation
innovation

Product innovations automation technology



Position sensors

Inductive sensors		
<i>Robust full-metal sensors for use in harsh environments</i>	(04.2017)	6 - 7
<i>Kplus sensors: one sensing range for all metals</i>	(04.2018)	8 - 11
<i>Electromagnetic field immune Kplus sensors for welding applications</i>	(04.2017)	12 - 13
Capacitive sensors		
<i>Ingeniously simple: display guide for the perfect setting</i>	(04.2018)	14 - 15
Magnetic sensors		
<i>Safety that attracts! Magnetically-coded sensors</i>	(04.2018)	16 - 17
<i>Highest protection against tampering with coded RFID sensors</i>	(04.2018)	18 - 19
Cylinder sensors		
<i>Cylinder sensors for robust fixing in C-slots</i>	(04.2018)	20 - 21
Ultrasonic sensors		
<i>Precise object detection under extreme conditions</i>	(11.2017)	22 - 23
<i>Object detection for long ranges and difficult surfaces</i>	(11.2017)	24 - 25
Laser sensors / distance sensors		
<i>Spot on! – the new O6 laser</i>	(04.2018)	26 - 27
<i>Millimetre perfect. The new OGD Precision from the PMDLine</i>	(04.2018)	28 - 29
<i>Farsighted – the OGD Long Range – new compact PMDLine sensor</i>	(04.2018)	30 - 31
<i>O1D with PMD technology – ready for Industry 4.0</i>	(04.2017)	32 - 33
Feedback systems for valves and valve actuators		
<i>Continuous position feedback and diagnostics</i>	(04.2018)	34 - 35
<i>Feedback for hand valves</i>	(04.2018)	36 - 37

TOP
TOP

TOP

Sensors for motion control

Encoders		
<i>Stainless steel, encoders for wet areas</i>	(04.2018)	38 - 39
<i>Programmable incremental hollow shaft encoder with IO-Link</i>	(11.2017)	40 - 41
Speed sensors		
<i>Compact speed sensors with ATEX approval and IO-Link</i>	(11.2017)	42 - 43
<i>Compact speed sensors with IO-Link</i>	(11.2017)	44 - 45
Systems for evaluation of standard signals		
<i>Multifunctional analogue display with IO-Link</i>	(04.2018)	46 - 47
Pulse evaluation systems		
<i>Multifunctional display: speed, time, counter</i>	(04.2017)	48 - 49



Industrial imaging

Camera systems for mobile machines		
<i>Augmented reality: mobile 3D smart camera with overlay function</i>	(04.2017)	50 - 51
<i>Robust 7.0" TFT LCD monitor for mobile machines</i>	(11.2017)	52 - 53
3D sensors		
<i>3D sensors for flexible automation of robot grippers</i>	(04.2018)	54 - 55
<i>Depalletising of uniform packages made easy</i>	(04.2018)	56 - 57



Process sensors

Pressure sensors		
<i>All at sea? Pressure, temperature, level and flow sensors with DNV-GL</i>	(04.2018)	58 - 59
<i>Process values from IO-Link sensors at a glance</i>	(04.2018)	60 - 61
<i>Pressure transmitter for hygienic applications with IO-Link and 4...20 mA</i>	(04.2018)	62 - 63
<i>Pressure sensors for water-based media</i>	(04.2018)	64 - 65
<i>Pressure transmitters with DEUTSCH, AMP or M12 connector for mobile applications</i>	(11.2017)	66 - 67
Flow sensors / flow meters		
<i>Calorimetric flow meter for liquids and gases</i>	(04.2017)	68 - 69
<i>New MID flow meter – now also for smallest quantities</i>	(11.2017)	70 - 71
Level sensors		
<i>Maintenance-free level detection where other systems fail</i>	(11.2017)	72 - 73
<i>Level and temperature values via one cable –thanks to IO-Link</i>	(11.2017)	74 - 75
<i>LK – Level measurement without float in machine tools</i>	(11.2017)	76 - 77
Temperature sensors		
<i>Infrared temperature sensor with IO-Link and LED pilot light</i>	(11.2017)	78 - 79
<i>Precise temperature sensors with internal drift monitoring</i>	(11.2017)	80 - 81
<i>Fast hygienic temperature transmitter up to 200 °C</i>	(11.2017)	82 - 83
<i>Sensors for the food industry with free factory certificate</i>	(11.2017)	84 - 85



Industrial communication

AS-Interface I/O modules		
<i>AS-i illuminated pushbutton module with M12 connector</i>	(04.2018)	86 - 87
AS-Interface Safety at Work		
<i>SafeLine SmartPLC: fail-safe automation system</i>	(11.2017)	88 - 89
AS-Interface wiring technology		
<i>Worldwide innovation: AS-i signal transmission via fibre optic</i>	(04.2018)	90 - 91

IO-Link

IO-Link master		
<i>IO-Link master for intelligent sensors in the control cabinet</i>	(11.2017)	92 - 93
<i>IO-Link master: connection of sensors to the PLC and to the IT world</i>	(11.2017)	94 - 95
<i>IO-Link master: connection for intelligent sensors</i>	(04.2017)	96 - 97
<i>IO-Link master for intelligent sensors in hygienic areas</i>	(04.2017)	98 - 99
<i>IO-Link master with extra power</i>	(04.2017)	100 - 101
<i>Starter kit IO-Link master</i>	(11.2017)	102 - 103





IO-Link

IO-Link modules		
<i>M8 input module converts digital signals to IO-Link signals</i>	(11.2017)	104 - 105
IO-Link devices		
<i>IO-Link modules collect and convert digital signals</i>	(04.2018)	106 - 107

Identification systems

RFID 13.56 MHz		
<i>RFID antenna with a 200 mm range and diagnostic LED</i>	(11.2017)	108 - 109
<i>All in one unit: RFID antenna, evaluation and CANopen interface</i>	(11.2017)	110 - 111
<i>Large selection of RFID antennas with IO-Link</i>	(04.2018)	112 - 113

TOP

Condition monitoring systems

Systems for vibration monitoring and diagnostics		
<i>Online condition monitoring with fieldbus interface</i>	(11.2017)	114 - 115
<i>Intelligent vibration monitoring – online or handheld</i>	(11.2017)	116 - 117
<i>New accelerometers for your machine health</i>	(11.2017)	118 - 119
Systems for signalling and indication		
<i>Configurable signal lamps</i>	(11.2017)	120 - 121

TOP

TOP

Systems for mobile machines

Controllers		
<i>ecomatController V3 – standard and safety controller in one unit</i>	(04.2018)	122 - 123
I/O modules		
<i>ioControl – rugged I/O module with integrated controller</i>	(11.2017)	124 - 125

Connection technology

Use in wet areas and in the food and beverage industry		
<i>ecolink M12, A coded – now wirable for hygienic and wet areas</i>	(04.2018)	126 - 127
<i>ecolink M12 cable with 1 mm² for reduced voltage drop</i>	(04.2017)	128 - 129
<i>ecolink M12 Ethernet D-Code for hygienic and wet areas</i>	(04.2017)	130 - 131
<i>ecolink M12 – new Y splitters for special applications</i>	(11.2017)	132 - 133

TOP



Position sensors

Robust full-metal sensors for use in harsh environments



Inductive sensors



Short:
ideal for tight spaces

Flexible: temperature range
from -40...85 °C

Sealed: protection ratings
IP 65 to IP 69K

Quality: high-grade stainless for
food processes

Solid:
shock and vibration resistant

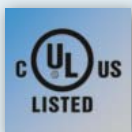

High reliability even under extreme conditions

Full-metal sensors are used wherever an application presents particular challenges to the mechanical design. In the food industry, for example, not only rapid changes of temperature but also aggressive media used for daily cleaning stress the housing material. The same applies to applications in machine tools and plants where the sensors are permanently exposed to coolants and lubricants. In the steel industry or in automotive industry, however, weld spatter is not only a strain on the sensing face but also on the threaded sleeve. In this context the full-metal design with non-stick coating and the robust sensing face are the ideal solution to ensure a safe operation.

Moreover, the robust stainless steel design offers optimum protection against abrasive parts in metal-cutting machining. Additionally, the compact and short design permits use even in the smallest of spaces.



Type	Total length [mm]	Sensing range [mm]	f [Hz]	Protection rating	Ambient temperature [°C]	Order no.
------	----------------------	-----------------------	-----------	-------------------	-----------------------------	-----------

M12 connector · output function NO · 3-wire DC PNP · coolant and oil lubricant

M12	45	4	100	IP 65, IP 66, IP 67, IP 68, IP 69K	-40...85	IFC275
M18	45	8	100	IP 65, IP 66, IP 67, IP 68, IP 69K	-40...85	IGC258
M30	50	15	50	IP 65, IP 66, IP 67, IP 68, IP 69K	-40...85	IIC233

M12 connector · output function NO · 3-wire DC PNP · welding area · anti-spatter

M12	45	4	2	IP 65, IP 66, IP 67, IP 68, IP 69K	-40...85	IFR207
M18	45	8	2	IP 65, IP 66, IP 67, IP 68, IP 69K	-40...85	IGR207
M30	50	15	2	IP 65, IP 66, IP 67, IP 68, IP 69K	-40...85	IIR207

M12 connector · output function NO · 3-wire DC PNP · hygienic and wet areas

M12	45	4	100	IP 65, IP 66, IP 67, IP 68, IP 69K	0...100	IFT257
M18	45	8	100	IP 65, IP 66, IP 67, IP 68, IP 69K	0...100	IGT258
M30	50	15	50	IP 65, IP 66, IP 67, IP 68, IP 69K	0...100	IIT243

Dimensions

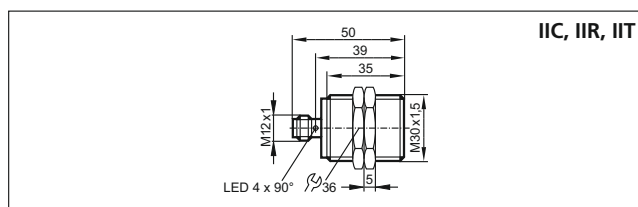
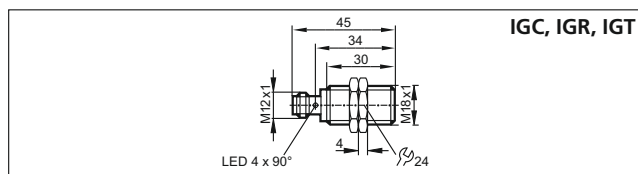
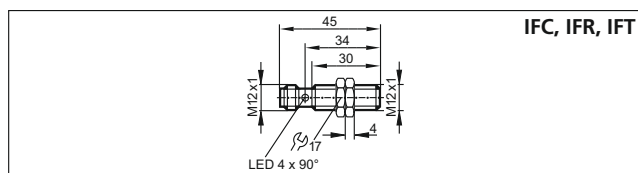

Connection technology

Type	Description	Order no.
	Socket, M12, 2 m black, PUR cable	EVC001
	Socket, M12, 5 m black, PUR cable	EVC002
	Socket, M12, 2 m grey, PUR cable	EVW001
	Socket, M12, 5 m grey, PUR cable	EVW002
	Socket, M12, 4-pole 2 m grey, PVC cable	EVF064
	Socket, M12, 4-pole 5 m grey, PVC cable	EVF001

Further technical data

Operating voltage	[V DC]	10...30
Current consumption	[mA]	< 10
Installation		flush
Reverse polarity protection		•
Short-circuit protection		•
Overload protection		•
Protection class		III
Housing materials		High-grade stainless steel (316L)
Switching status indication	[LED]	yellow (4 x 90°)

Wiring diagram

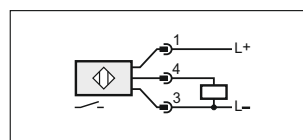

Accessories

Type	Description	Order no.
	Angle bracket for type M12, stainless steel	E10735
	Angle bracket for type M18, stainless steel	E10736
	Angle bracket for type M30, stainless steel	E10737



Position sensors

Kplus sensors: One sensing range for all metals



Inductive sensors



Uniform sensing range for the reliable detection of all metals

Compact size for use in the smallest of spaces

Electromagnetic field immune sensor technology to prevent incorrect switching

High-quality stainless steel housing

IP 65 / IP 69K for greater reliability

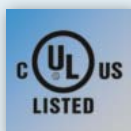
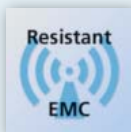
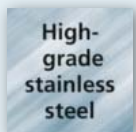
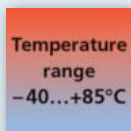
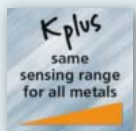

Constant correction factor

Inductive Kplus sensors have the same sensing range for all types of metal. So they are perfectly suited for the detection of aluminium, e.g., where conventional sensors show a considerably reduced sensing range. Moreover, high switching frequencies allow the monitoring of fast-moving targets.

Versatile use

The resistant stainless steel sleeve is also perfectly suited for applications with continuous contact with oils and coolants. The large temperature range as well as the high protection ratings allow universal use of the new sensors. The M8 Kplus sensors are now also available in all common cable versions.



Design	Total length [mm]	Sensing range [mm]	Installation	Output	Output function	Order no.
--------	----------------------	-----------------------	--------------	--------	-----------------	-----------

M8 connector- 3-wire DC

M8	40	3	flush	PNP	normally open	IES200
M8	40	6	non flush	PNP	normally open	IES201

Connection cable 2 m PUR · 3-wire DC

M8	37.5	3	flush	PNP	normally open	IES202
M8	37.5	6	non flush	PNP	normally open	IES203
M8	37.5	3	flush	PNP	normally closed	IES204
M8	37.5	6	non flush	PNP	normally closed	IES205
M8	37.5	3	flush	NPN	normally closed	IES206
M8	37.5	6	non flush	NPN	normally closed	IES207
M8	37.5	3	flush	NPN	normally open	IES208
M8	37.5	6	non flush	NPN	normally open	IES209

Accessories

Design	Description	Order no.
	Angle bracket for type M8, stainless steel	E10734

Connection technology

Design	Description	Order no.
	Socket, M8, 3-pole 2 m black, PUR cable	EVC141
	Socket, M8, 3-pole 5 m black, PUR cable	EVC142

Further technical data

Operating voltage	[V DC]	10...30
Reverse polarity protection		•
Short-circuit protection		•
Overload protection		•
Protection rating		IP 65 / IP 66 / IP 67 / IP 68 / IP 69K
Switching frequency	[Hz]	2000
Protection class		III
Ambient temperature	[°C]	-40...85
Housing materials		high-grade stainless steel (316L), sensing face LCP
Output status indication	[LED]	yellow (4 x 90°)

Wiring diagram

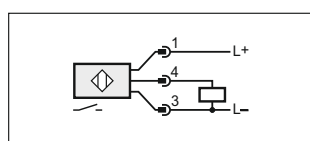

IES200 / IES201

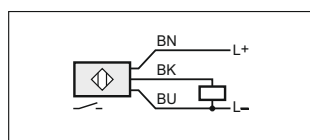
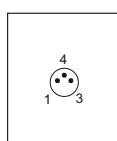

IES202 / IES203

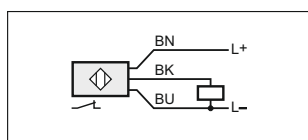

IES204 / IES205

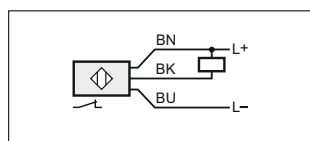

IES206 / IES207

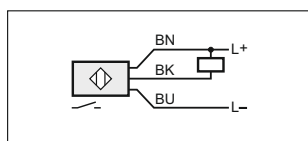

IES208 / IES209

Dimensions

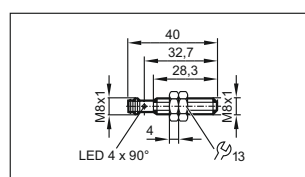

IES200

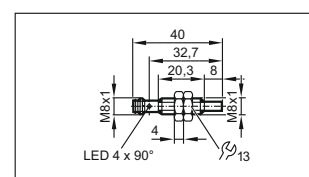

IES201

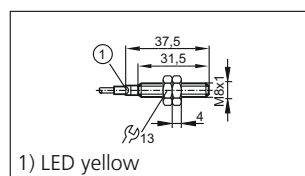

IES202 / IES204 / IES206 / IES208

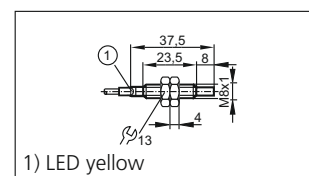

IES203 / IES205 / IES207 / IES209



Position sensors

Kplus sensors: one sensing range for all metals



Inductive sensors



Uniform sensing range for the reliable detection of all metals

Compact dimensions for use in the smallest of space

Electromagnetic field immune sensor technology to prevent incorrect switching

High-quality stainless steel housing

High reliability thanks to protection rating from IP 65 / IP 69K

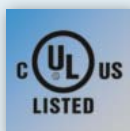
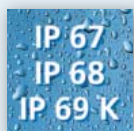
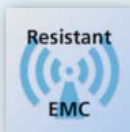
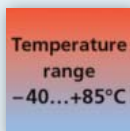
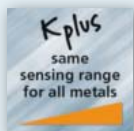

Constant correction factor





Kplus sensors have the same sensing range for all types of metals. They are for example perfectly suited for the detection of aluminium, where conventional sensors show a considerably reduced sensing range. The high switching frequencies enable the monitoring of fast changing switching states.

The resistant stainless steel sleeve allows reliable use in oil and coolant applications. The wide temperature range as well as the high protection ratings enable universal use of the new Kplus sensors.



Type	Total length [mm]	Sensing range [mm]	Installation	Switching frequency [Hz]	Current rating [mA]	Order no.
M12 connector · 3 wire DC PNP · Output function normally open						
M12	45	4	flush	2000	100	IFS297
M12	45	8	non-flush	2000	100	IFS298
M12	45	10	non-flush	2000	100	IFS299
M12	60	4	flush	2000	100	IFS304
M12	60	8	non-flush	2000	100	IFS305
M12	60	10	non-flush	2000	100	IFS306
M18	45	8	flush	2000	100	IGS287
M18	45	12	non-flush	2000	100	IGS288
M18	45	15	non-flush	2000	100	IGS289
M18	60	8	flush	2000	100	IGS290
M18	60	12	non-flush	2000	100	IGS291
M18	60	15	non-flush	2000	100	IGS292
M30	45	15	flush	2000	100	IIS281
M30	60	15	flush	2000	100	IIS282
M30	60	22	non-flush	2000	100	IIS283
M30	60	30	non-flush	2000	100	IIS284

Connection technology

Type	Description	Order no.
	Socket, M12, 2 m black, PUR cable	EVC001
	Socket, M12, 5 m black, PUR cable	EVC002
	Socket, M12, 2 m black, PUR cable	EVC004
	Socket, M12, 5 m black, PUR cable	EVC005

Further technical data

Operating voltage	[V DC]	10...30
Reverse polarity protection		•
Short-circuit protection		•
Overload protection		•
Protection rating		IP 65 / IP 66 / IP 67 / IP 68 / IP 69K
Protection class		III
Ambient temperature	[°C]	-40...85
Housing materials		High-grade stainless steel (316L) sensing face LCP
Output status indication	[LED]	yellow (4 x 90°)

Dimensions

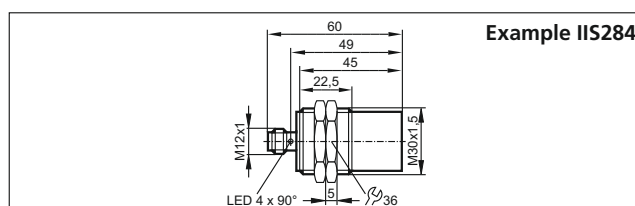
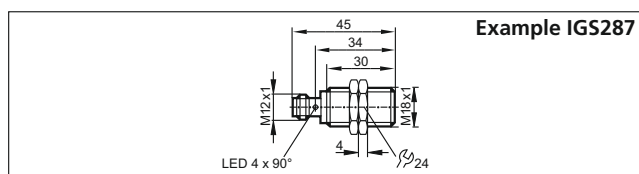
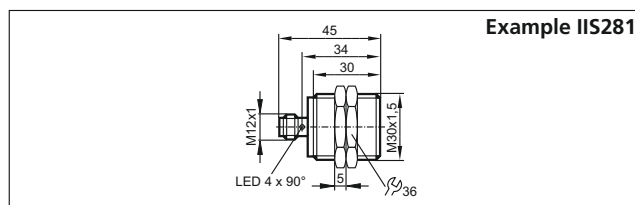
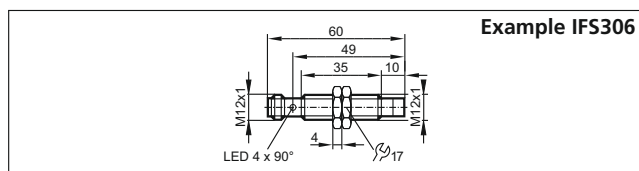
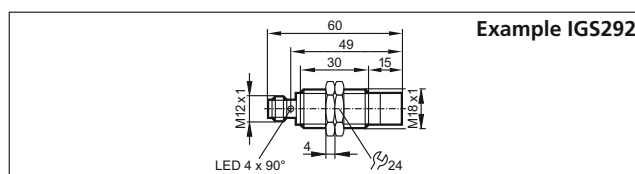
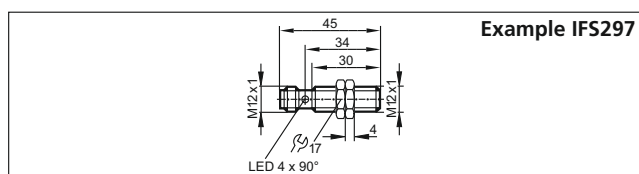



Positions sensors

Electromagnetic field immune Kplus sensors for welding applications



Inductive Sensors



Uniform sensing range for the reliable detection of all metals

Robust design with non-stick coating

Electromagnetic field immune sensor technology to prevent incorrect switching

Wide temperature range for universal use

High protection ratings up to IP 68 / IP 69K

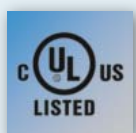
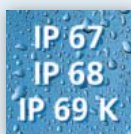
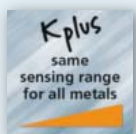
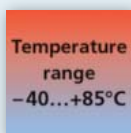

Use in harsh welding applications

The inductive Kplus sensors withstand harsh operating conditions and reliably detect metal objects even in case of soiling.

The sensor housing and the fixing nuts have a non-stick coating to prevent sticking of weld slag. Strong magnetic fields occur in welding processes. The new sensor technology prevents incorrect switching.

The quick connection with the connector and matching cable from the ecolink range is the ideal basis for permanent use.



Type	Total length [mm]	Sensing range [mm]	Installation	Switching frequency [Hz]	Current load [mA]	Order no.
M8 connector · 3 wire DC PNP · Output function normally open · stainless steel (316L) anti-spatter						
M8	40	3	flush	2000	100	IEW200
M8	40	6	non flush	2000	100	IEW201
M12 connector · 3 wire DC PNP · Output function normally open · brass anti-spatter						
M12	65	4	flush	2000	100	IFW204
M18	65	8	flush	2000	100	IGW202
M30	65	15	flush	2000	100	IIW202



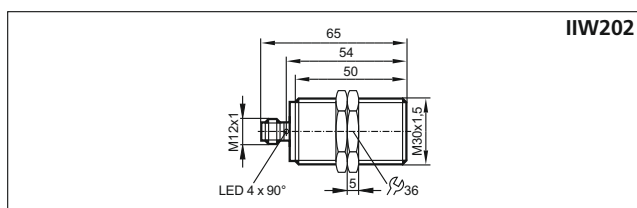
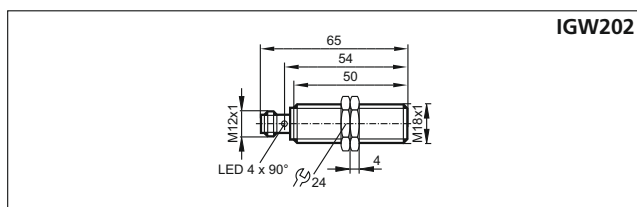
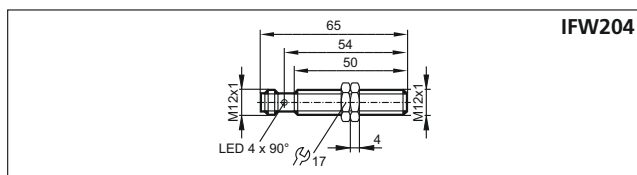
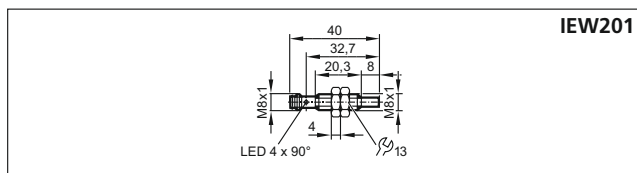
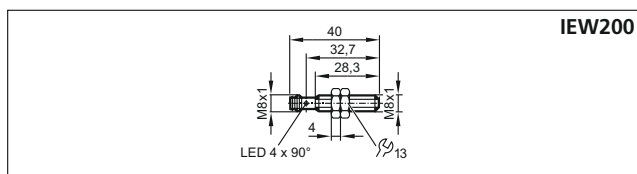



Dimensions





Further technical data

Operating voltage	[V DC]	10...30
Current consumption	[mA]	< 20
Reverse polarity protection		•
Short-circuit protection		•
Overload protection		•
Protection		IP 65 / IP 66 / IP 67 / IP 68 / IP 69K
Protection class		II
Ambient temperature	[°C]	-40...85
Housing materials sensing face		LCP
Switching status indication	[LED]	yellow (4 x 90°)

Accessories

Type	Description	Order no.
	M12 mounting sleeve with end stop, anti-spatter	E12452
	M18 mounting sleeve with end stop, anti-spatter	E12453
	M30 mounting sleeve with end stop, anti-spatter	E12454
	M12 washers, anti-spatter	E12412
	M18 washers, anti-spatter	E12413
	M30 washers, anti-spatter	E12414

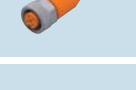
Connection technology

Type	Description	Order no.
	Socket, M12, 2 m grey, PUR cable	EVW001
	Socket, M12, 5 m grey, PUR cable	EVW002
	Socket, M12, 2 m grey, PUR cable	EVW004
	Socket, M12, 5 m grey, PUR cable	EVW005



Position sensors

Ingeniously simple: display guide for the perfect setting



Capacitive sensors



Unique visualisation and handling concept via LED display

See and compensate switch point movement

IP 69K gives high ingress resistance

PNP/NPN, NO/NC, timer function

For medium temperatures up to 110 °C



Visualised switch point

The new capacitive sensors stand out not only because of their excellent technical data but most of all with their new and unique visualisation concept. Using a 12-LED bar display of the PerformanceLine the user can always adapt the switch point to suit the application conditions – it is always in the centre of the display. The green LEDs either side of the switch point indicate the reliability of the switch point. Deposits, material changes etc. are displayed directly on the sensor and the user can readjust the switch point precisely as needed. An imminent error can be detected in good time and avoided thus minimising the risk of failures or deactivation.

If help is needed with the effects of process changes this is much easier to explain and rectify with the LED display. Over the phone the user can describe the LED behaviour and a support engineer can easily advise corrective measures.



Type	Output stage	Setting range [mm]	Communication interface	Sensing range [mm]	Protection rating/ protection class	Order no.
------	--------------	-----------------------	----------------------------	-----------------------	--	--------------

PerformanceLine · connection cable 2 m PUR· 3 wires

M30	PNP, NO/NC	0.5...40	IO-Link COM 2	25 nf	IP 65, IP 67, IP 69K / III	KI6001
M18	PNP, NO/NC	0.5...30	IO-Link COM 2	15 nf	IP 65, IP 67, IP 69K / III	KG6001

PerformanceLine · M12 connector ·3 wires

M30	PNP, NO/NC	0.5...40	IO-Link COM 2	25 nf	IP 65, IP 67, IP 69K / III	KI6000
M18	PNP, NO/NC	0.5...30	IO-Link COM 2	15 nf	IP 65, IP 67, IP 69K / III	KG6000

StandardLine · connection cable 2 m PUR· 3 wires

M30	NPN, NO	0.5...40	IO-Link COM 2	25 nf	IP 65, IP 67, IP 69K / III	KI5300
M30	PNP, NC	0.5...40	IO-Link COM 2	25 nf	IP 65, IP 67, IP 69K / III	KI5301
M30	NPN, NC	0.5...40	IO-Link COM 2	25 nf	IP 65, IP 67, IP 69K / III	KI5302
M30	PNP, NO	0.5...40	IO-Link COM 2	25 nf	IP 65, IP 67, IP 69K / III	KI5303
M30	PNP, NC	0.5...24	IO-Link COM 2	15 qf	IP 65, IP 67, IP 69K / III	KI5304
M30	PNP, NO	0.5...24	IO-Link COM 2	15 qf	IP 65, IP 67, IP 69K / III	KI5305

StandardLine · M12 connector ·3 wires

M30	NPN, NO	0.5...40	IO-Link COM 2	25 nf	IP 65, IP 67, IP 69K / III	KI5306
M30	PNP, NC	0.5...40	IO-Link COM 2	25 nf	IP 65, IP 67, IP 69K / III	KI5307
M30	NPN, NO	0.5...40	IO-Link COM 2	25 nf	IP 65, IP 67, IP 69K / III	KI5308
M30	PNP, NO	0.5...40	IO-Link COM 2	25 nf	IP 65, IP 67, IP 69K / III	KI5309
M30	PNP, NC	0.5...24	IO-Link COM 2	15 qf	IP 65, IP 67, IP 69K / III	KI5310
M30	PNP, NO	0.5...24	IO-Link COM 2	15 qf	IP 65, IP 67, IP 69K / III	KI5311
M18	NPN, NO	0.5...30	IO-Link COM 2	15 nf	IP 65, IP 67, IP 69K / III	KG5306
M18	PNP, NC	0.5...30	IO-Link COM 2	15 nf	IP 65, IP 67, IP 69K / III	KG5307
M18	NPN, NO	0.5...30	IO-Link COM 2	15 nf	IP 65, IP 67, IP 69K / III	KG5308
M18	PNP, NO	0.5...30	IO-Link COM 2	15 nf	IP 65, IP 67, IP 69K / III	KG5309
M18	PNP, NC	0.5...9	IO-Link COM 2	8 qf	IP 65, IP 67, IP 69K / III	KG5310
M18	PNP, NO	0.5...9	IO-Link COM 2	8 qf	IP 65, IP 67, IP 69K / III	KG5311



Mounting accessories

Type	Description	Order no.
	Fixing clamp with reducing bush for M18 types	E10076
	Fixing clamp with reducing bush for M30 types	E10077
	Mounting clamp with end stop for M18 types	E11048
	Mounting clamp with end stop for M30 types	E11049
	Mounting adapter for M30 types, G 1 1/4", POM	E11033
	Mounting adapter for M30 types, G 1 1/4", PVDF	E11036
	Mounting adapter for M18 types, G 3/4", POM	E43900
	Mounting adapter for M18 types, G 1", PVDF	E43904

Further technical data

Operating voltage	[V DC]	10...30
Switching frequency	[HZ]	40
Short-circuit protection		•
Reverse polarity / overload protection		• / •
Ambient temperature	[°C]	-25...80
Medium temperature	[°C]	-25...110
Housing material		PBT

IO-Link accessories

Type	Description	Order no.
	Memory plug, parameter memory for IO-Link sensors	E30398
	LR DEVICE (supplied on USB flash drive) Software for online and offline parameter setting of IO-Link sensors	QA0011
	USB IO-Link master for parameter setting and analysis of units Supported communication protocols: IO-Link (4.8, 38.4 and 230 kBits/s)	E30390



Position sensors

Safety that attracts! Magnetically-coded sensors



Magnetic sensors



Activation from different directions aids installation

Conceal behind stainless steel for enhanced tamper prevention

Connect in series and still identify which door is open

Meets the new interface description CB24I from ZVEI

Meets highest safety level to ISO 13849-1 and SILCL 3 to IEC 62061

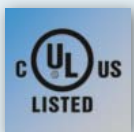
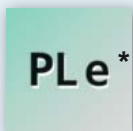

Non-contact door monitoring

Magnetic sensors allow monitoring of the door status without contact.
* Can reach PL e to ISO 13849-1 and SILCL 3 to IEC 62061 when used with suitable evaluation units.

Easy connection

Various connection versions with cable, M8 connector (4-pin) and M12 connector (4-pin) provide a standardised connection. With the UL and EAC approvals your machine can be operated worldwide without any concerns.

Easy installation

The standard designs in a small and large version ensure various applications even if there is only little space.



Type	Dimensions [mm]	Sensing range [mm]	Connection	Contacts	Order no.
------	-----------------	--------------------	------------	----------	-----------

Function principle: magnetically coded · actuator is supplied

	36 x 26 x 13	5	2 m, PVC	2 x NC	MN200S
	36 x 26 x 13	5	6 m, PVC	2 x NC	MN201S
	36 x 26 x 13	5	M8, 4-pin, integrated	2 x NC	MN202S
	36 x 26 x 13	5	0.1 m, PVC, M12 connector	2 x NC	MN203S
	36 x 26 x 13	5	2 m, PVC	2 x NC / 1 x NO	MN204S
	36 x 26 x 13	5	6 m, PVC	2 x NC / 1 x NO	MN205S
	88 x 25 x 13	8	2 m, PVC	2 x NC	MN500S
	88 x 25 x 13	8	6 m, PVC	2 x NC	MN501S
	88 x 25 x 13	8	M8, 4-pin, integrated	2 x NC	MN502S
	88 x 25 x 13	8	0.1 m, PVC, M12 connector	2 x NC	MN503S
	88 x 25 x 13	8	2 m, PVC	2 x NC / 1 x NO	MN504S
	88 x 25 x 13	8	6 m, PVC	2 x NC / 1 x NO	MN505S

Safe connection

In combination with for example the G1501S relay or the AC041S monitor the sensors have a TÜV approval up to SILCL 3 and PL e.

This safety level can also be attained with the ifm SmartPLC such as AC422S.

Which door is open?

The sensors with 3 contacts (signal contact) provide the possibility of a series connection with the information which door was opened. There are 2 contacts for the safety circuit and an additional signal for the non-safe controller.

Better protection against tampering

Since the sensors can look through stainless steel or aluminium, hidden installation is possible thus improving protection against tampering.

Robust installation

Thanks to the metal reinforcement on the mounting holes of the MN5xxS safe and robust installation of the sensor is possible.

High performance

Stable switching characteristics thanks to broad switch-on/switch-off graph. The sensor can be approached with the coded actuator from different directions.

Connection technology

Type	Description	Order no.
	Socket, M12, 4-pole 2 m black, PUR cable	EVC001
	Socket, M8, 4-pole 2 m black, PUR cable	EVC150

Common technical data

Ambient temperature	[°C]	-25...80
Output characteristics to CB24I Ed. 2.0		Interface type A
Potential-free		•
Coding level to EN14119		Low

Accessories

Type	Description	Order no.
	Safety relay, Combicon connector with screw terminals	G1501S
	Safety relay, Combicon connector with screw terminals	G1502S
	AS-i safety monitor, Combicon connector with screw terminals	AC041S
	SafeLine SmartPLC, 2 x AS-i, EtherNet/IP device	AC422S
	Small actuator	E1101S
	Spacer for MN2 magnetic sensors	E1258S
	Large actuator	E1104S
	Spacer for MN5 magnetic sensors	E12586



Position sensors

Highest protection against tampering with coded RFID sensors



RFID sensors



Unique actuator coding prevents tampering

Connect up to 32 sensors in series with the safety integrity remaining at the same level

Flashing LEDs monitor sensing area

Programme the sensor as often as desired ensuring easy set-up

Meets the new interface description CB24I from ZVEI

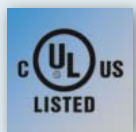
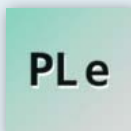

Preventive maintenance

The sensors can display switch-off operation of the sensors directly using the LED display if the actuator slowly leaves the sensing range. This means that for example the door and the actuator can be ideally paired to each other and higher machine uptime is achieved. They meet the requirements ISO 13849-1 and IEC 62061. Even if 32 sensors are connected in series, the highest safety level is maintained.

Non-contact door monitoring

The non-contact RFID sensors allow reliable monitoring of the door status without any wear.



Type	Dimensions [mm]	Sensing range [mm]	Connection	Coding	Series connection possible	Order no.
Function principle: RFID-coded · actuator is supplied						
	72 x 25 x 18	12	M12 connector, 5-pole	coded	–	MN700S
	72 x 25 x 18	12	M12 connector, 8-pole	uniquely coded	•	MN701S
	72 x 25 x 18	12	M12 connector, 8-pole	codable	•	MN702S
	72 x 25 x 18	12	2 m, PVC cable, 5-pole	coded	–	MN703S
	72 x 25 x 18	12	2 m, PVC cable, 8-pole	uniquely coded	•	MN704S
	72 x 25 x 18	12	2 m, PVC cable, 8-pole	codable	•	MN705S

Safe connection

With the sensors as sub-systems it is possible to implement safety functions up to PL e to ISO 13849-1 or SILCL 3 to IEC 62061.

The safety classification of the sensors is available on the ifm website for download in a library according to VDMA standard sheet 66413 such as SISTEMA.

Preventive maintenance

The sensors allow display of an uncertain sensor state directly on site using the LED display if the actuator is no longer close enough to the sensor.

Common technical data		
Operating voltage	[V DC]	24 (± 10 %)
Sensing range	[mm]	12
Safe switch-off distance	[mm]	16
Contacts		2 x OSSD, 1 x PNP
Ambient temperature	[°C]	-25...80
Output characteristics		Interface type C, class 2
Coding level to EN14119 for MN701S, MN704S		High
Accessories		Actuator, 4 washers, 8 cover caps

Connection technology

Type	Description	Order no.
	Socket, M12, 5-pole 2 m black, PUR cable	EVC544
	Socket, M12, 2 m black, PUR cable, 8-pole	E11950

Accessories

Type	Description	Order no.
	Safety relay, Combicon connector with screw terminals	G1501S
	Safety relay, Combicon connector with screw terminals	G1502S
	AS-i safety monitor, Combicon connector with screw terminals	AC041S
	SafeLine SmartPLC, 2 x AS-i, EtherNet/IP device	AC422S
	Actuator coded	E1102S
	Actuator codable	E1103S
	One way screw M4 x 20, pack quantity 10 pieces	E12584

Wiring

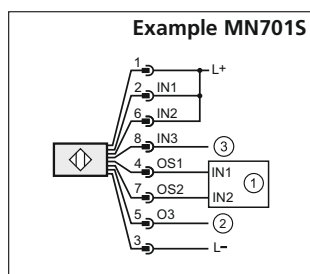

- 1) Safety-related logic unit
- 2) Programmable logic controller (PLC)
- 3) not used



Cylinder sensors for robust fixing in C-slots



Cylinder sensors



Sensor for easy mounting in C-slots

Robust fixing at the housing end for strong strain relief

Connection and switching output variants for any application

Electronic GMR measuring cell for a long sensor life

Now also available as 2-wire version for PNP or NPN PLC's

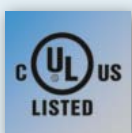

Flush in the C-slot

The cylinder sensor can be used for the common C-slot such as for SMC. Its height of only 5 mm allows flush mounting. Especially this cylinder manufacturer requires slot-mounting and, often, 2-wire connection.

Long life

The sensors function without contact and almost without wear. Their life is much longer than that of the common reed contacts.

With the GMR cell (giant magneto resistive), the sensor detects the magnet on the piston through the aluminium wall of the cylinder. This saves expensive repair and downtimes.



Design	Electrical description	Connection	Material	Ambient temperature [°C]	Order no.
--------	------------------------	------------	----------	--------------------------	-----------

Cylinder sensor C-slot

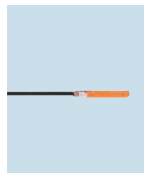
	2-wire, PNP/NPN	Pigtail 0.3 m, M8 connector	plastic PA (polyamide)	-25...80	MK5362
	2-wire, PNP/NPN	Pigtail 0.3 m, M12 connector	plastic PA (polyamide)	-25...80	MK5363
	2-wire, PNP/NPN	2 m PUR cable, open end	plastic PA (polyamide)	-25...80	MK5365

Dimensions

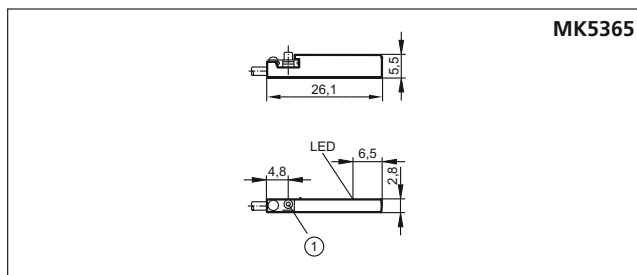
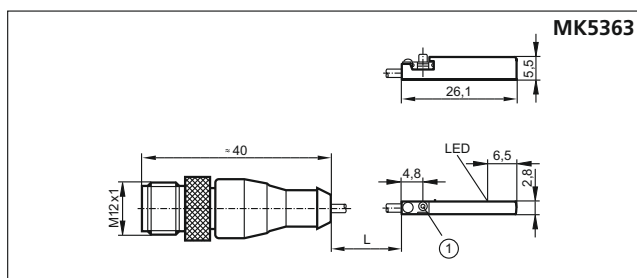
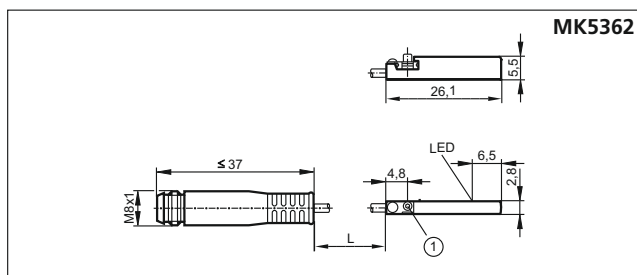

1) Clamping screw

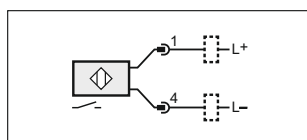

Wiring diagram







Further technical data

Operating voltage	[V DC]	10...30
Protection		IP 65 / IP 67
Short-circuit protection		•
Switching frequency	[Hz]	4000
Switching status indication	LED	yellow
UL approval		•

Accessories

Design	Description	Order no.
	C-slot cylinder memorisation block	E12004
	Switched-mode power supply 24 V DC, 2.5 A	DN1031

Connection technology

Design	Description	Order no.
	Socket, M12, 4 poles 2 m black, PUR cable	EVC001
	Socket, M8, 4 poles 2 m black, PUR cable	EVC150
	Y splitter, 1 x M12 connector, 5 poles, 2 x M12 socket	EBC117
	Y splitter, 1 x M12 connector, 4 poles, 2 x M12 socket	EBC118



Position sensors

Precise object detection under extreme conditions



Ultrasonic sensors



Robust high-grade stainless steel housing for demanding applications

Sensing range up to 1.2 m in M18 cube design and 2.2 m in M18 design

The vibrating sound transducer reduces the deposit of dirt

Retro-reflective operation for orientation-independent object detection

Easy setting via teach button, wire teach or IO-Link



The alternative for difficult surfaces

Ultrasonic sensors transmit and receive sound waves in the ultrasonic range. The object to be detected reflects the sound waves and the distance information is determined via time of flight measurement. As opposed to photoelectric sensors, colour, transparency or the object's surface shine do not play a role. Blister packages in packaging technology or transparent plastic bowls in the food industry, for example, can be reliably detected.

High performance

The ifm ultrasonic sensors in M18 design provide a particularly small blind zone and long sensing ranges which are usually only achieved by sensors of a considerably larger design.









The sensors operate reliably with heavy soiling so that they can be used in applications in which photoelectric sensors meet their limits.



Type	Housing length/ dimensions [mm]	Setting	Output	Order no.	Order no.	Order no.	Order no.	Order no.
Ultrasonic diffuse-reflection sensor · 3-wire DC, 4-pole				300 mm*	800 mm*	1200 mm*	1600 mm*	2200 mm*
M18	60	Wire	PNP	UGT500	UGT503	UGT506	–	–
M18	60	Wire	NPN	UGT521	UGT522	UGT523	–	–
M18	60	Wire	4...20 mA	UGT501	UGT504	UGT507	–	–
M18	60	Wire	0...10 V	UGT502	UGT505	UGT508	–	–
M18	60	IO-Link	PNP	UGT524	UGT525	UGT526	–	–
Ultrasonic diffuse-reflection sensor · 3-wire DC, 4-pole				300 mm*	800 mm*	1200 mm*	1600 mm*	2200 mm*
M18 Cube	53 x 20 x 38	Pushbutton	PNP + 4...20 mA	UGT580	UGT582	UGT584	–	–
M18 Cube	53 x 20 x 38	Pushbutton	PNP + 0...10 V	UGT581	UGT583	UGT585	–	–
M18 Cube	53 x 20 x 38	Pushbutton	NPN + 4...20 mA	UGT586	UGT588	UGT590	–	–
M18 Cube	53 x 20 x 38	Pushbutton	NPN + 0...10 V	UGT587	UGT589	UGT591	–	–
M18 Cube	53 x 20 x 38	Pushbutton, IO-Link	PNP	UGT592	UGT593	UGT594	–	–
Ultrasonic diffuse-reflection sensor · 3-wire DC, 4-pole				300 mm*	800 mm*	1200 mm*	1600 mm*	2200 mm*
M18	98	Pushbutton, IO-Link	2 x PNP	–	–	–	UGT509	UGT512
M18	98	Pushbutton, IO-Link	PNP + 4...20 mA	–	–	–	UGT510	UGT513
M18	98	Pushbutton, IO-Link	PNP + 0...10 V	–	–	–	UGT511	UGT514
M18	98	Pushbutton	2x NPN	–	–	–	UGT515	UGT518
M18	98	Pushbutton	NPN + 4...20 mA	–	–	–	UGT516	UGT519
M18	98	Pushbutton	NPN + 0...10 V	–	–	–	UGT517	UGT520
Ultrasonic retro-reflective sensor · 3-wire DC, 3-pole				300 mm*	800 mm*	1200 mm*	1600 mm*	2200 mm*
M18	98	Pushbutton, IO-Link	PNP	–	–	–	UGR500	UGR501
M18	98	Pushbutton	NPN	–	–	–	UGR502	UGR503

* Max. range



Accessories

Type	Description	Order no.
	Sound tube, M18, POM	E23000
	Sound deflection angle for sensors with a range of ≤ 1,2 m, stainless steel	E23001
	Sound deflection angle for sensors with a range of ≤ 2,2 m, stainless steel	E23002
	Mounting set for clamp mounting, diecast zinc, Ø 12 mm	E20720
	Mounting set for clamp mounting, stainless steel, Ø 12 mm	E21206
	Mounting set for clamp mounting, diecast zinc, Ø 12 mm	E20721
	Mounting set for clamp mounting, stainless steel, Ø 12 mm	E21207
	Rod, 100 mm, Ø 12 mm, M10 thread, stainless steel	E20938
	Cube for mounting on an aluminium profile, M10 thread, diecast zinc	E20951

Common technical data

Operating voltage	[V DC]	10...30
Current rating	[mA]	100
Switching output		
Operating temperature range	[°C]	-20...70
Temperature compensation		•
Protection		IP 67
Connection		M12 connector
Status indications	LED	yellow
Echo	LED	green

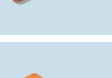
Connection technology

Type	Description	Order no.
	Socket, M12, 4-pole 2 m black, PUR cable	EVC001
	Socket, M12, 4-pole 5 m black, PUR cable	EVC002
	Socket, M12, 4-pole 2 m black, PUR cable	EVC004
	Socket, M12, 4-pole 5 m black, PUR cable	EVC005

ifm – close to you!

For further technical details please visit: www.ifm.com
(11.2017)



Position sensors

Object detection for long ranges and difficult surfaces

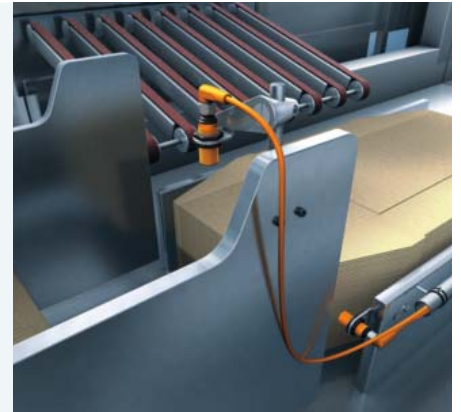

Ultrasonic sensors



M18 plastic housing available in the two lengths 60 mm and 98 mm

Long ranges from 300 mm to 2200 mm available

The vibrating sound transducer reduces the deposit of dirt

Digital and analogue output for point level measurement and distance detection

Easy setting via teach button, wire teach or IO-Link



Ultrasound



TEACH-IN



IO-Link

The alternative for difficult surfaces

Ultrasonic sensors transmit and receive sound waves in the ultrasonic range. The object to be detected reflects the sound waves and the distance information is determined via time of flight measurement. As opposed to photoelectric sensors colour, transparency or the object's surface shine do not play a role. Blister packages in packaging technology or transparent plastic bowls in the food industry, for example, can be reliably detected.

High performance

The ifm ultrasonic sensors in M18 design provide a particularly small blind zone and long sensing ranges which are usually only achieved by sensors of a considerably larger design.

The sensors operate reliably with heavy soiling so that they can be used in applications in which photoelectric sensors meet their limits.



Type	Housing length/ dimensions [mm]	Setting	Output	Order no.	Order no.	Order no.	Order no.	Order no.
Ultrasonic diffuse-reflection sensor · 3-wire DC, 4-pole				300 mm*	800 mm*	1200 mm*	1600 mm*	2200 mm*
M18	60	Wire	PNP	UGT200	UGT201	UGT202	–	–
M18	60	Wire	NPN	UGT209	UGT210	UGT211	–	–
M18	60	IO-Link	PNP	UGT212	UGT213	UGT214	–	–
Ultrasonic diffuse-reflection sensor · 3-wire DC, 4-pole				300 mm*	800 mm*	1200 mm*	1600 mm*	2200 mm*
M18	98	Pushbutton, IO-Link	2 x PNP	–	–	–	UGT203	UGT206
M18	98	Pushbutton, IO-Link	PNP + 4...20 mA	–	–	–	UGT204	UGT207
M18	98	Pushbutton, IO-Link	PNP + 0...10 V	–	–	–	UGT205	UGT208

* Max. range

Accessories

Type	Description	Order no.
	Sound tube, M18, POM	E23000
	Sound deflection angle for sensors with a range of ≤ 1,2 m, stainless steel	E23001
	Sound deflection angle for sensors with a range of ≤ 2,2 m, stainless steel	E23002
	Mounting set for clamp mounting, diecast zinc, Ø 12 mm	E20720
	Mounting set for clamp mounting, stainless steel, Ø 12 mm	E21206
	Mounting set for clamp mounting, diecast zinc, Ø 12 mm	E20721
	Mounting set for clamp mounting, stainless steel, Ø 12 mm	E21207
	Rod, 100 mm, Ø 12 mm, M10 thread, stainless steel	E20938
	Rod, 200 mm, Ø 10 mm, M10 thread, stainless steel	E20940
	Cube for mounting on an aluminium profile, M10 thread, diecast zinc	E20951

Common technical data		
Operating voltage	[V DC]	10...30
Current rating	[mA]	100
Switching output		
Operating temperature range	[°C]	-20...70
Temperature compensation		•
Protection		IP 67
Connection		M12 connector
Status indications	LED	yellow
Echo	LED	green

Connection technology

Type	Description	Order no.
	Socket, M12, 4-pole 2 m black, PUR cable	EVC001
	Socket, M12, 4-pole 5 m black, PUR cable	EVC002
	Socket, M12, 4-pole 2 m black, PUR cable	EVC004
	Socket, M12, 4-pole 5 m black, PUR cable	EVC005

Wiring

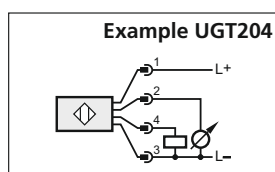



Position sensors

Spot on! – the new O6 laser



Laser sensors



Whole family of laser sensors in a market standard housing with 1" centres

The distance value to the object can be provided via IO-Link

Precise setting via tactile teach buttons or IO-Link

Uniform light spot for reliable, precise detection

Consistent laser alignment in all units

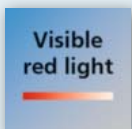

Precise laser for the detection of tiny objects

The new O6 with laser protection class 1 enables reliable detection of tiny objects where conventional red light sensors reach their limits. One of its highlights is that it features IO-Link as a standard feature.

IO-Link opens up completely new perspectives

Similar to analogue sensors, the distance value in mm to the object can be provided via IO-Link. This turns a binary diffuse reflection laser sensor into a precise distance measurement system. New application possibilities include length and height monitoring.

Besides, inspection tasks such as the detection of the presence of parts or their correct installation are possible via the precise distance detection. The sensor features a reliable range of 100 mm, even for objects with different colours. With IO-Link, the user is now well prepared for Industry 4.0.



Design [H, W, D]	Range [mm]	Spot Ø at max. range* [mm]	Connection	Order no.	Order no.
Diffuse reflection sensor with background suppression, 3-wire DC				PNP IO-Link 1.1	NPN
Rectangular 35 x 13 x 21 mm	100	2	2 m, PUR cable	O6H700	O6H703
	100	2	0.3 m PUR cable / M12 connector, 4-pole	O6H701	O6H704
	100	2	M8 connector, 4-pole	O6H702	O6H705
Retro-reflective sensor with polarisation filter, 3-wire DC				PNP IO-Link 1.1	NPN
Rectangular 35 x 13 x 21 mm	300...8000**	< 17	2 m, PUR cable	O6P700	O6P703
	300...8000**	< 17	0.3 m PUR cable / M12 connector, 4-pole	O6P701	O6P704
	300...8000**	< 17	M8 connector, 4-pole	O6P702	O6P705
Through-beam sensor transmitter, DC					
Rectangular 35 x 13 x 21 mm	15000	< 35	2 m, PUR cable	O6S700	
	15000	< 35	0.3 m PUR cable / M12 connector, 4-pole	O6S701	
	15000	< 35	M8 connector, 4-pole	O6S702	
Through-beam sensor receiver, 3-wire DC				PNP IO-Link 1.1	NPN
Rectangular 35 x 13 x 21 mm	15000	–	2 m, PUR cable	O6E700	O6E703
	15000	–	0.3 m PUR cable / M12 connector, 4-pole	O6E701	O6E704
	15000	–	M8 connector, 4-pole	O6E702	O6E705

* at max. range / ** referred to prismatic reflector E20722

Accessories

Design	Description	Order no.
	Mounting set for clamp mounting, stainless steel, Ø 10 mm	E21272
	Rod, 120 mm, Ø 10 mm, M8 thread, stainless steel	E21081
	USB IO-Link master for parameter setting and analysis of units Supported communication protocols: IO-Link (4.8, 38.4 and 230 kBit/s)	E30390
	LR DEVICE (supplied on USB flash drive) Software for online and offline parameter setting of IO-Link sensors and actuators	QA0011
	Socket, M12, 2 m black, PUR cable	EVC001
	Socket, M12, 5 m black, PUR cable	EVC002
	Socket, M8, 4-pole 2 m black, PUR cable	EVC150
	Socket, M8, 4-pole 5 m black, PUR cable	EVC151

Common technical data

Operating voltage	[V DC]	10...30
Type of light / wave length		laser light 650 nm
Laser protection class		1
Output		H / D
H = light-on / D = dark-on mode		selectable
Protection rating, protection class		IP 65 / IP 67 III
Switching frequency	[Hz]	1000
Switching status indication	LED	yellow
Operation	LED	green
Current rating	[mA]	100
Voltage drop	[V]	< 2.5
Short-circuit protection, pulsed		•
Reverse polarity protection / overload protection		• / •
Ambient temperature	[°C]	-10...60
Materials	Housing Lens	ABS; PPSU PMMA



Position sensors



Millimetre perfect. The new OGD Precision from the PMDLine



Laser sensors / distance sensors



Small compact design with standard M18 thread and time of flight technology

Precise distance measurement to the nearest millimetre

Distance value shown on 2-colour display and sent via IO-Link

Easy setting with 3-buttons or IO-Link

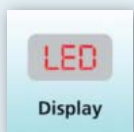

Precise ToF distance sensor for demanding applications

Thanks to the innovative on-chip time-of-flight principle with PMD technology (photonic mixer device), this sensor offers all the capability of a very precise measurement system. The distance information can determine the presence of parts or their correct installation, e.g. if an O-ring has or has not been mounted. The excellent reflection resistance and background suppression, together with a high excess gain, enable reliable operation.

The PMD technology of the OGD is vastly superior to conventional diffuse reflection laser sensors. The OGD Precision is available with an extremely small light spot at a 300 mm range to detect very small parts.

Easy handling

The switch point is easily set to the nearest millimetre via the three operating keys or alternatively via IO-Link, which also allows read-out of the current distance value.



Measuring range [mm]	Background suppression [m]	Output	Laser protection class	Spot Ø at max. range [mm]	Unit of measurement	Order no.
----------------------	----------------------------	--------	------------------------	---------------------------	---------------------	-----------

Photoelectric distance sensor · M12 connector, complementary

25...300	...18	PNP	1	3*	mm, inch (selectable)	OGD592
----------	-------	-----	---	----	-----------------------	---------------

* spot Ø focussed (at 150 mm): 1 mm

Accessories

Type	Description	Order no.
Installation		
	Mounting set for clamp mounting, M10 thread, diecast zinc	E20718
	Mounting set for clamp mounting, M10 thread, stainless steel	E20870
	Mounting set for clamp mounting, Ø 12 mm, diecast zinc	E20836
	Mounting set for clamp mounting, Ø 12 mm, stainless steel	E21207
	Rod, 100 mm, Ø 12 mm, M10 thread, stainless steel	E20938
	Cube for mounting on an aluminium profile, M10 thread, diecast zinc	E20951

IO-Link

	USB IO-Link master for parameter setting and analysis of units Supported communication protocols: IO-Link (4.8, 38.4 and 230 kBit/s)	E30390
	Memory plug, parameter memory for IO-Link sensors	E30398
	IO-Link master with Profinet interface	AL1100
	LR DEVICE (supplied on USB flash drive) Software for online and offline parameter setting of IO-Link sensors and actuators	QA0011

Connection technology

	Socket, M12, 2 m black, PUR cable	EVC001
	Socket, M12, 5 m black, PUR cable	EVC002
	Socket, M12, 2 m black, PUR cable	EVC004
	Socket, M12, 5 m black, PUR cable	EVC005

Further technical data

Operating voltage	[V DC]	10...30
Type of light / wave length		laser light 650 nm
Laser protection class		1
Output	H = light-on mode / D = dark-on mode	light-on / dark-on selectable
Protection rating, protection class		IP 65 / IP 67 III
Extraneous light immunity	[klx]	10
Switching status indication	LED	2 x yellow
Switching frequency	[Hz]	11
Current rating	[mA]	2 x 100
Current consumption	[mA]	75
Short-circuit protection, pulsed		•
Reverse polarity protection / overload protection		• / •
Ambient temperature	[°C]	-25...50
Materials	Housing	stainless steel (1.4404/316L); ABS; PPSU; PMMA
	Lens	glass

Dimensions

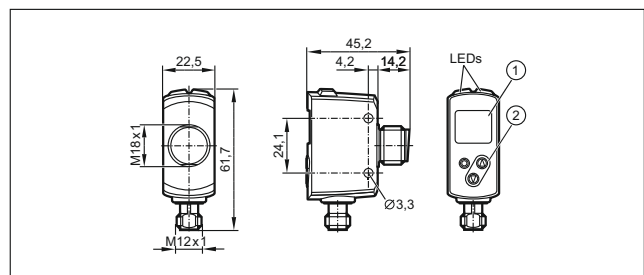

Wiring diagram

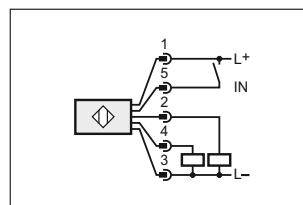



Position sensors



Farsighted – the OGD Long Range – new compact PMDLine sensor



Laser sensors / distance sensors



Small compact design with standard M18 thread and time of flight technology

Excellent range of 1.5 m – independent of the colour

Visualisation and setting of the distance value via IO-Link and 2-colour display on the unit

Sensors with laser protection class 1 – perfectly suited for the automotive industry

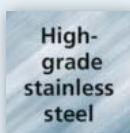
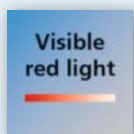

Long-range time of flight sensor for demanding applications

The new PMDLine sensor with a compact stainless steel housing is distinguished by a very long range. It uses the innovative on-chip time-of-flight measurement system with PMD (photonic mixer device) technology. The class 1 laser sensor performs better than conventional red light sensors even in very demanding circumstances e.g. in detecting shiny metallic surfaces. The excellent reflection resistance and background suppression, together with a high excess gain, enable reliable operation. Typical applications are found in the automotive industry, conveying and materials handling.

Easy handling

The switch point is easily set using the three buttons on the unit or alternatively via IO-Link, which also allows read-out of the current distance value.



Measuring range [mm]	Background suppression [m]	Output	Laser protection class	Spot Ø at max. range [mm]	Unit of measurement	Order no.
----------------------	----------------------------	--------	------------------------	---------------------------	---------------------	-----------

Photoelectric distance sensor · M12 connector, complementary

25...150020	PNP	1	5	mm, inch (selectable)	OGD580
-----------	--------	-----	---	---	-----------------------	---------------

Accessories

Design	Description	Order no.
--------	-------------	-----------

Installation

	Mounting set for clamp mounting, M10 thread, diecast zinc	E20718
	Mounting set for clamp mounting, M10 thread, stainless steel	E20870
	Mounting set for clamp mounting, Ø 12 mm, diecast zinc	E20836
	Mounting set for clamp mounting, Ø 12 mm, stainless steel	E21207
	Rod, 100 mm, Ø 12 mm, M10 thread, stainless steel	E20938
	Cube for mounting on an aluminium profile, M10 thread, diecast zinc	E20951

IO-Link

	USB IO-Link master for parameter setting and analysis of units Supported communication protocols: IO-Link (4.8, 38.4 and 230 kBit/s)	E30390
	Memory plug, parameter memory for IO-Link sensors	E30398
	IO-Link-master with PROFINET interface	AL1100
	LR DEVICE (supplied on USB flash drive) Software for online and offline parameter setting of IO-Link sensors and actuators	QA0011

Connection technology

	Socket, M12, 2 m black, PUR cable	EVC001
	Socket, M12, 5 m black, PUR cable	EVC002
	Socket, M12, 2 m black, PUR cable	EVC004
	Socket, M12, 5 m black, PUR cable	EVC005

Further technical data

Operating voltage	[V DC]	10...30
Type of light / wave length		laser light 650 nm
Laser protection class		1
Output		H / D selectable
H = light-on / D = dark-on mode		
Protection rating, protection class		IP 65 / IP 67 III
Extraneous light immunity	[klx]	10
Switching status indication	LED	2 x yellow
Switching frequency	[Hz]	11
Current rating	[mA]	2 x 100
Current consumption	[mA]	75
Short-circuit protection, pulsed		•
Reverse polarity protection / overload protection		• / •
Ambient temperature	[°C]	-25...60
Materials	Housing	stainless steel (1.4404/316L)
	Lens	ABS; PPSU; PMMA glass

Dimensions

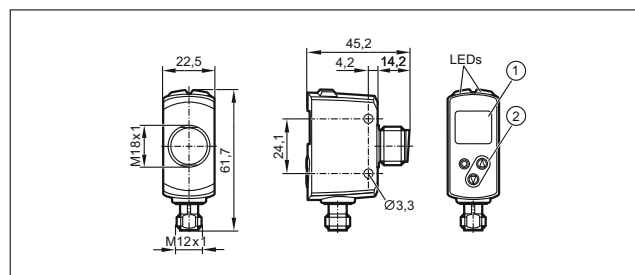

Wiring diagram

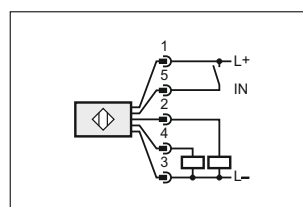



Position sensors

O1D with PMD technology – ready for Industry 4.0

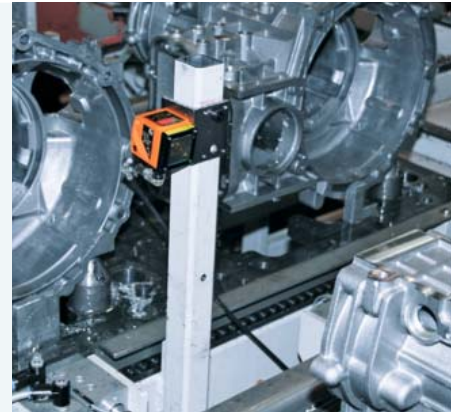

Laser sensors / distance sensors



Optical distance detection with a range of up to 10 m

2 switching outputs; one output can be configured as analogue output

Resistant to extraneous light up to 100,000 lux

Can be used in applications needing background suppression

IO-Link for easy setting and replacement of sensors



PMD distance sensors with IO-Link

Thanks to the innovative on-chip time-of-flight principle with PMD technology, this sensor offers all the capability of a measurement system. It now comes with IO-Link functionality for simpler parameter setting and distance value transmission. The signal strength can now be sent via IO-Link. This makes it possible to distinguish many different components within the same application by their object contrasts.

O1D is insensitive to extraneous light up to 100,000 lux and remains unaffected even if direct sunlight hits the sensor or target, thus operating reliably and accurately at all times.



Electrical design	Background suppression [m]	Switching outputs	Laser class	Sampling rate [Hz]	Spot diameter [mm]	Operating range [m]	Order no.
-------------------	----------------------------	-------------------	-------------	--------------------	--------------------	---------------------	-----------

Distance detection

DC PNP	0...19	2*	2	max. 50, adjustable	15 x 15 (at 10 m)	0.2...10	O1D120
--------	--------	----	---	---------------------	-------------------	----------	---------------

* one switching output can be configured as analogue output (0...10 V or 4...20 mA)

Dimensions

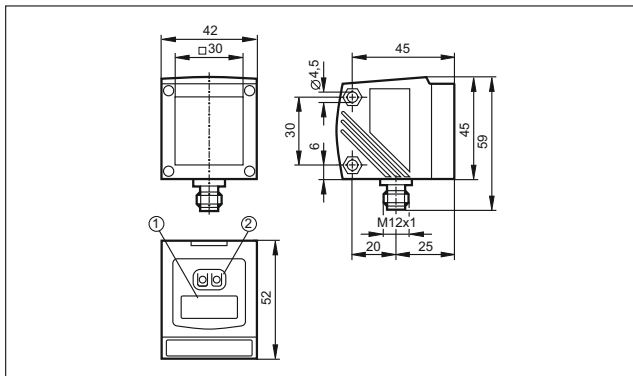

- 1) 4-digit alphanumeric display
2) Programming buttons

Accessories

Type	Description	Order no.
	Mounting set for clamp mounting, Ø 12 mm, stainless steel	E2D101
	Cube for mounting on an aluminium profile, M10 thread, diecast zinc	E20951
	Protective cover, plastic, PMMA	E21133
	Protective cover, glass	E21171
	Cooling and protection box, aluminium	E21248
	Memory plug, parameter memory for IO-Link sensors	E30398
	USB IO-Link master for parameter setting and analysis of units Supported communication protocols: IO-Link (4.8, 38.4 and 230 Kbits/s)	E30390
	LR DEVICE (supplied on USB flash drive) Software for online and offline parameter setting of IO-Link sensors and actuators	QA0011

Further technical data

Type O1D		
Operating voltage [V]		18...30 DC
Connection		M12 connector
Protection		IP 67 / III
Short-circuit protection, pulsed		•
Reverse polarity / overload protection		• / •
EMC		EN 60947-5-2
Material	Housing Front lens LED window	diecast zinc glass polycarbonate
Function display		
Switching status	LED	yellow
Operation	LED	green
Distance value, programming		4-digit alphanumeric display

Connection technology

Type	Description	Order no.
	Socket, M12, 2 m black, PUR cable	EVC001
	Socket, M12, 5 m black, PUR cable	EVC002
	Socket, M12, 2 m black, PUR cable	EVC004
	Socket, M12, 5 m black, PUR cable	EVC005
	Socket, M12, 2 m orange, PVC cable	EVT064
	Socket, M12, 5 m orange, PVC cable	EVT001
	Socket, M12, 2 m orange, PVC cable	EVT067
	Socket, M12, 5 m orange, PVC cable	EVT004



Position sensors



Continuous position feedback and diagnostics



Valve feedback systems



Great all-round position visibility from a distance

Continuous position feedback

Easy setting via teach button or IO-Link

Diagnostic functions: cycle time and count, seal monitoring



Flexible configuration

The smart valve sensor matches settings to the application software (LR Device) or inductive teach button. Any end position of the valve and the size of the sensing range can be set. A third switch point can be selected, for example for three-way valves or for switching off the pump to avoid pressure peaks.

Diagnostic functions

The IO-Link communication interface allows the identification of different wear conditions. On the one hand, the sensor features seal monitoring indicating a change of the closed position, which can point to deposits or wear of the seal, for example. On the other hand, the different positions can be counted and the time taken can be measured.





U _b [V DC]	Ambient temperature [°C]	VDI/VDE 3845	Housing materials	Output function	Protection	Order no.
--------------------------	-----------------------------	--------------	-------------------	-----------------	------------	-----------





Smart valve sensor · M12 connector

10...30	-25...70	80 x 20	PA; stainless steel plug	3 x NO / NC (selectable)	IP 65 / IP 67	MVQ101
---------	----------	---------	-----------------------------	-----------------------------	---------------	---------------



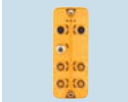

Accessories

Design	Description	Order no.
	Adapter 80 x 30 x 10 mm	E12569
	Adapter 130 x 30 x 10 mm	E12573

Accessories IO-Link

Design	Description	Order no.
	USB IO-Link master for parameter setting and analysis of units Supported communication protocols: IO-Link (4.8, 38.4 and 230 kBit/s)	E30390
	Memory plug, parameter memory for IO-Link sensors	E30398
	IO-Link master with PROFINET interface	AL1100
	LR DEVICE (supplied on USB flash drive) Software for online and offline parameter setting of IO-Link sensors and actuators	QA0011

Connection technology

Design	Description	Order no.
	Socket, M12, 2 m black, PUR cable	EVC001
	Socket, M12, 5 m black, PUR cable	EVC002
	Socket, M12, 2 m black, PUR cable	EVC004
	Socket, M12, 5 m black, PUR cable	EVC005

Further technical data

Detection range	[°]	360
Reverse polarity protection		•
Short-circuit protection		•
Resolution	[°]	0.1
Tolerance	[°]	± 0.1...15
Repeatability	[°]	0.1
Type of transmission		COM2 (38.4 kbaud)
IO-Link revision		1.1
Min. process cycle time	[ms]	4
Required master port class		A
SIO mode		•
Profiles		Smart sensor: Device Identification; Device Diagnosis; Device Teach Channel; Binary Data Channel; Process Data Variable; Measurement Data Channel

Dimensions

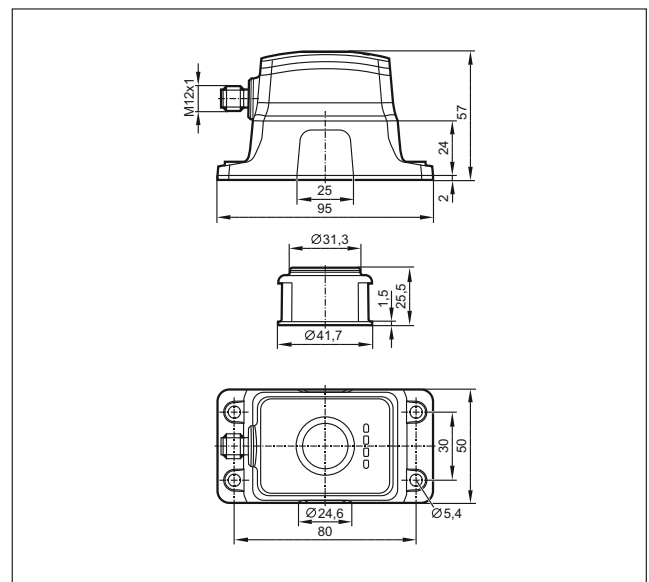

Wiring diagram

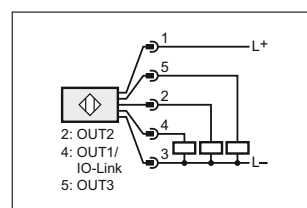



Position sensors

Feedback for hand valves



Valve sensors, accessories



Suitable for ISO top flange valves from F03 to F16

Easy installation on manual valves and ball valves

Height-adjustable for flexibility

Stainless steel components for long life

Ideal for hazardous areas



End position feedback for manual valves and ball valves

With this mounting kit, you can very easily equip your manual valves with sensors and target pucks. A large number of sensors and pucks can be used on the 80 x 30 mm actuator interface to VDI/VDE 3845. The entire system can be used at ambient temperatures from -30 to +80 °C.

Versatile and flexible

The upper part is made out of Vestamid and allows operation in hazardous areas. The lower part fits on many ISO flange valves (DIN EN ISO 5211) and is connected to the valve shaft by a shaft extension.



Stainless steel components guarantee increased service life.



Accessories

Type	Description	Order no.
	Inductive sensor, PBT, M12 connector	IN5327
	Puck, basic	E12517
	Spacer for ifm puck, PA (required)	E12526
	Plug for covering the oblong holes, EPDM	E12212
	NAMUR sensor (1D, 1G, 2G), M12 connector	NN5008
	Switching amplifiers for Namur sensors, 2 channels	N0532A
	AS-i sensor, M12 connector	AC2315

Connection technology

Type	Description	Order no.
	Socket, M12, 5 m orange, PVC cable	EVT001
	Socket, M12, ATEX approval 5 m, blue, PUR cable	ENC02A

Dimensions

Top flange Ø [mm]	ISO top flange type	Shaft extension	Order no.
36	F03	M4	E12588
42	F04	M5	E12519
50	F05	M4	E12589
50	F05	M5	E12520
50	F05	M6	E12521
70	F07	M6	E12522
70	F07	M8	E12523
102	F10	M8	E12524
125	F12	M10	E12590
140	F14	M10	E12591
165	F16	M10	E12592

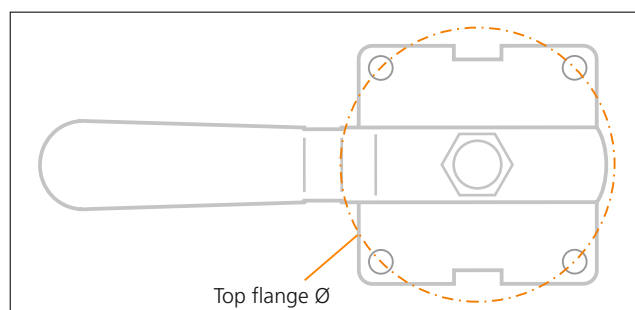

Mounting

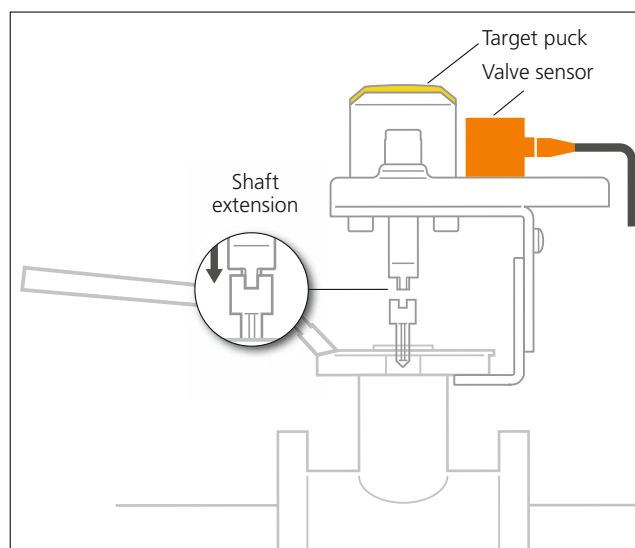



Sensors for motion control

Stainless steel encoders for wet areas



Encoders



Longevity: Stainless-steel housing for corrosion resistance

Cost reduction: IO-Link allows the use of three-core cables

Permanent: Clearly legible laser type label

No loss of values: Can also be configured as singleturn encoder via IO-Link

Programmable parameters mean fewer types needed

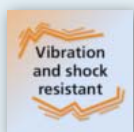
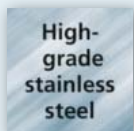

For demanding environmental conditions

ifm's stainless steel incremental encoders, for applications such as conveyor belt synchronisation, ensure longer maintenance intervals in harsh environments. The increased protection rating IP 67 qualifies them for use in wet areas in the food industry.

Versatile thanks to IO-Link

All incremental encoders from ifm operate like absolute singleturn encoders when used on IO-Link. They detect and save their position value even if power fails.

IO-Link communication

Process values, parameter setting and diagnostic data can be transmitted via IO-Link. Preventive maintenance is now as easy as child's play.





Housing Ø [mm]	Shaft Ø [mm]	Flange	Resolution [pulses / revolution]	Connection	IO-Link	Order no.
Solid shaft						
58	10	clamp	max. 10,000 (adjustable)	M12, 5-pole	•	RV3110
58	6	synchro	max. 10,000 (adjustable)	M12, 5-pole	•	RU3110
Hollow shaft with 2 integrated stator couplings						
58	15	direct	max. 10,000 (adjustable)	M12, 5-pole	•	RO3110

Accessories

Type	Description	Order no.
	Reducing bush for RO3, ROP designs 15...14 mm	E60210
	Reducing bush for RO3, ROP designs 15...10 mm	E60211
	Reducing bush for RO3, ROP designs 15...8 mm	E60212
	Reducing bush for RO3, ROP designs 15...6 mm	E60213
	Reducing bush for RO3, ROP designs 15...12 mm	E60214
	Stator coupling for RO design stainless steel (301 / 1.4310)	E60205
	Fastening clamp	E60041
	Target wheel, circumference / shaft diameter 500 mm / 10 mm	E60217
	Bellows coupling with adjusting screws, Ø 6 mm / 10 mm	E60215
	Bellows coupling with adjusting screws, Ø 10 mm / 10 mm	E60216





Connection technology

Type	Description	Order no.
	Socket, M12, shielded, 2 m, orange, PVC cable, 5-pole	EVT405
	Socket, M12, shielded, 5 m, orange, PVC cable, 5-pole	EVT406
	Socket, M12, wet areas, 2 m, grey, MPPE cable, 5-pole	EVF480
	Socket, M12, wet areas, 5 m, grey, MPPE cable, 5-pole	EVF481
	IO-Link master Profinet, 4-port	AL1101
	IO-Link master EtherNet/IP, 4-port	AL1121

Further technical data

Operating voltage	[V DC]	4.75...30
Switching frequency	[kHz]	1000
Protection		IP 67 / IP 67 (on the housing); IP 67 (on the shaft)
Materials	Flange	high-grade stainless steel (316Ti / 1.4571)
	Housing	stainless steel (443 / 1.4521)
	Shaft	high-grade stainless steel (316Ti / 1.4571)
	Plug	stainless steel (316 / 1.4401)

Accessories IO-Link

Type	Description	Order no.
	USB IO-Link master for parameter setting and analysis of units. Supported communication protocols: IO-Link (4.8, 38.4 and 230 kBit/s)	E30390
	Adapter cable for the connection between E30390 USB IO-Link master and 3-pole / 8-pole encoder	E12432
	LR DEVICE (supplied on USB flash drive) Software for online and offline parameter setting of IO-Link sensors and actuators	QA0011
	Memory plug, parameter memory for IO-Link sensors	E30398
	IO-Link display, connection to master	E30391
	IO-Link display, connection between master and sensor (incl. Y splitter)	E30430



Sensors for motion control

Programmable incremental hollow shaft encoder with IO-Link



Encoders



Flexible: Resolution of 1...10,000 freely programmable

Simple: Signal level can be set in TTL or HTL logic

Universal: M12 connector can be used radially or axially

Adaptable: Hollow shaft diameter can be reduced via reducing bushes

Communicative: Transfer of process, parameter and diagnostic data via IO-Link

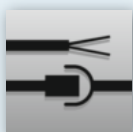

No compromises

The magnetic sensing principle provides the accuracy of photoelectric encoders and the robustness of magnetic systems.

The days of confusing type variety and encoders with complicated programming are finally over! The new incremental encoders from ifm electronic can be used universally due to the intelligent product and function design, and stand out thanks to a superb price/performance ratio:

- Set the resolution individually
- Choose between TTL or HTL logic
- Use the rotatable M12 connector radially or axially

IO-Link communication

Process values, parameter setting and diagnostic data can be transmitted via IO-Link. This makes preventive service as easy as child's play.



Ø housing [mm]	Ø shaft [mm]	Flange	Resolution [pulse/revolution]	Connection	IO-Link	Order no.
-------------------	-----------------	--------	----------------------------------	------------	---------	-----------



Hollow shaft with integrated stator coupling

36.5	6	direct	max. 10,000 (adjustable)	M12	•	RA3100
36.5	6	direct	max. 10,000 (adjustable)	cable, 2 m	•	RA3500
58	12	direct	max. 10,000 (adjustable)	M12	•	RO3100
58	15	direct	max. 10,000 (adjustable)	M12	•	RO3102
58	9.525	direct	max. 10,000 (adjustable)	M12	•	RO3103
58	15.875	direct	max. 10,000 (adjustable)	M12	•	RO3104
58	12	direct	max. 10,000 (adjustable)	cable, 2 m	•	RO3500



Hollow shaft with 2 integrated stator couplings

36.5	6	direct	max. 10,000 (adjustable)	M12	•	RA3101
36.5	6	direct	max. 10,000 (adjustable)	cable, 2 m	•	RA3501
58	12	direct	max. 10,000 (adjustable)	M12	•	RO3101
58	12	direct	max. 10,000 (adjustable)	cable, 2 m	•	RO3501
58	15	direct	max. 10,000 (adjustable)	M12	•	ROP522
58	9.525	direct	max. 10,000 (adjustable)	M12	•	ROP523
58	15.875	direct	max. 10,000 (adjustable)	M12	•	ROP524

Accessories

Type	Description	Order no.
	Reducing bush for designs RO3, ROP 15...14 mm	E60210
	Reducing bush for designs RO3, ROP 15...10 mm	E60211
	Reducing bush for designs RO3, ROP 15...8 mm	E60212
	Reducing bush for designs RO3, ROP 15...6 mm	E60213
	Reducing bush for designs RO3, ROP 15...12 mm	E60214
	Stator coupling for RO design stainless steel (1.4310 / 301)	E60205
	Stator coupling for RA design stainless steel (1.4310 / 301)	E60204





Connection technology

Type	Description	Order no.
	M12 socket, shielded, 2 m black, PUR cable, 5 poles	EVC544
	M12 socket, shielded, 5 m black, PUR cable, 5 poles	EVC545
	M12 socket, shielded, 2 m black, PUR cable, 8 poles	E12402
	M12 socket, shielded, 5 m black, PUR cable, 8 poles	E12403
	Jumper cable, 5 poles M23 connector / M12 socket	E12459
	Jumper cable, 8 poles M23 connector / M12 socket	E12460

Further technical data

Operating voltage	[V DC]	4.75...30
Switching frequency	[kHz]	1000
Protection		IP 65, IP 67

Accessories

Type	Description	Order no.
	USB IO-Link master for parameter setting and analysis of units Supported communication protocols: IO-Link (4.8, 38.4 and 230 kBit/s)	E30390
	Adapter cable for connection between USB IO-Link master E30390 and 3-pole / 8-pole encoder	E12432
	LR DEVICE (supplied on USB flash drive) Software for online and offline parameter setting of IO-Link sensors and actuators	QA0011
	Memory plug, parameter memory for IO-Link sensors	E30398
	IO-Link display, connection to master	E30391
	IO-Link display, connection between master and sensor (incl. Y splitter)	E30430



Compact speed sensors with ATEX approval and IO-Link



Speed sensors



Many functions available via IO-Link, but also in SIO mode

Robust M30 metal housing:
No additional impact protection required

ATEX approval
group II, category 3D

Flush installation

Connector unit with 24 V DC
supply voltage



Compact speed monitoring with IO-Link

The evaluation electronics are integrated in the sensor housing. This allows for low-cost and easy monitoring of rotating as well as linear movements regarding overspeed and underspeed.

The limit of the speed at which the output switches is set via a potentiometer or IO-Link.

New: Sensor with M12 connector and ATEX approval

As compared to its predecessors, these new sensors feature a robust metal housing for flush mounting.

A special version with ATEX approval is available for which no additional impact protection is required.



Type	Setting range [pulses/min.]	Start-up delay [s]	Hysteresis [%]	Communication interface	ATEX approval	Order no.
------	--------------------------------	-----------------------	-------------------	----------------------------	---------------	--------------

Inductive sensor M30 x 1.5 · M12 connector · IO-Link

	5...3600	15	10	–	–	DI5023
	5...3600	15	10	–	Group II, category 3D	DI521A
	5...3600	5	10	–	Group II, category 3D	DI522A
	5...3600	15 adjustable	10	IO-Link	–	DI5024
	5...3600	15 adjustable	10	IO-Link	Group II, category 3D	DI524A

Applications

Especially in the field of conveying technology the compact speed sensors can be used for various applications, for example for monitoring belt conveyors or bucket elevators. Here they are typically used to monitor underspeed, blockage or standstill.

Functions via IO-Link

The speed sensors incorporate complete speed monitoring. The switch point is set using a multi-turn potentiometer or IO-Link. Additional values are provided via IO-Link, for example the current speed or the set switch point. Parameters such as the start-up delay can be set remotely using IO-Link. Besides, the "window mode" can be activated via IO-Link. Two switch points that can be set independently of each other provide added value. Teaching can also be done remotely via IO-Link. To increase plant transparency, a connection to the ifm SMARTOBSERVER is possible. Of course it is also possible to operate the IO-Link enabled sensor in SIO mode.

Operating principle

The integrated inductive sensor is damped by passing cams or other metallic targets. The evaluation unit determines the period duration or the frequency (actual rotational speed value) on the basis of the time interval between damping and compares it to the set switch point (preset value). The output is switched during the start-up delay and when the rotational speed exceeds the set switching value.

An LED signals underspeed and switch-off of the output.

Dimensions

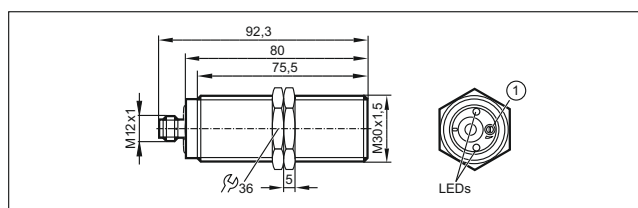

1) Potentiometer

Further technical data

Operating voltage	[V DC]	10...36
Current consumption	[mA]	< 22
Switch point adjustment		Multiturn potentiometer or IO-Link
Sensing range	[mm]	10, flush
Short-circuit protection		•
Reverse polarity / overload protection		• / •
Protection		IP 65, IP 67
Protection class		III
Switching status indication	LED	green
Housing materials		CuZn; plastic; Stainless steel (1.4308)

Accessories

Type	Description	Order no.
	Target wheel	E89010
	Clamp with damping cams	E89013
	Angle bracket for M30 designs	E10737
	Lock nuts, nickel-plated brass	E10030
	Lock nuts, high-grade stainless steel (1.4571/316Ti)	E10031
	Mounting set, free-standing M12 clamp mounting, Ø 30.2 mm	E20874
	Mounting set, aluminium profile clamp mounting, Ø 30.2 mm	E20875
	USB IO-Link master for parameter setting and analysis of units Supported communication protocols: IO-Link (4.8, 38.4 and 230 kBit/s)	E30390
	LR DEVICE (supplied on USB flash drive) Software for online and offline parameter setting of IO-Link sensors and actuators	QA0011



Sensors for motion control

Compact speed sensors with IO-Link



Speed sensors



Various designs for different applications

Adjustable modes, e.g. single, two point or window mode

Many additional functions via IO-Link

Flush and non flush

Connector unit with 24 V DC supply voltage



Compact speed monitoring

The evaluation electronics are integrated in the sensor housing. This allows for low-cost and easy monitoring of rotating as well as linear movements regarding overspeed and underspeed. The limit of the speed at which the output switches is set via IO-Link.

Applications

Especially in the field of conveying technology the compact speed sensors can be used for various applications, for example for monitoring belt conveyors or bucket elevators. Here they are typically used to monitor underspeed, blockage or standstill. The different designs and the large speed range allow for an integration into almost any application.



Type	Installation	Setting range [pulses/min.]	Start-up delay [s]	Operating voltage [V DC]	Hysteresis [%]	Order no.
Inductive sensor · M12 connection · IO-Link						
M12	flush	5...24,000	0...30	10...30	10	DI5027
M12	non flush	5...24,000	0...30	10...30	10	DI5028
M18	flush	5...24,000	0...30	10...30	10	DI5029
M18	non flush	5...24,000	0...30	10...30	10	DI5030
M30	flush	5...14,400	0...30	10...30	10	DI5031
M30	non flush	5...14,400	0...30	10...30	10	DI5032
Rectangular	flush	5...9,600	0...30	10...30	10	DI5033
Rectangular	non flush	5...9,600	0...30	10...30	10	DI5034

Functions via IO-Link

The speed sensors incorporate complete speed monitoring. Additional values are provided via IO-Link, for example the current speed or the set switch point. Parameters such as the start-up delay can be set remotely using IO-Link. Besides, the "window mode" can be activated via IO-Link. Two switch points that can be set independently of each other provide added value. Teaching can also be done remotely via IO-Link.

Due to the optional background compensation it is possible to adjust the sensing range through "teaching" in order to suppress interfering elements in the background.

To increase plant transparency, a connection to the ifm SMARTOBSERVER is possible.

Of course it is also possible to operate the IO-Link enabled sensor in SIO mode.

Operating principle

The integrated inductive sensor is damped by passing cams or other metallic targets.

The evaluation unit determines the period duration or the frequency (actual rotational speed value) on the basis of the time interval between damping and compares it to the set switch point (preset value).

The output is switched during the start-up delay and when the rotational speed exceeds the set switching value. An LED signals underspeed and switch-off of the output.

Accessories

Type	Description	Order no.
	Target wheel	E89010
	Clamp with damping cams	E89013
	Angle bracket for M12 design, stainless steel	E10735
	Angle bracket for M18 design, stainless steel	E10736
	Angle bracket for M30 design, stainless steel	E10737
	Lock nuts M12 x 1, high-grade stainless steel (1.4571/316Ti)	E10025
	Lock nuts M18 x 1, high-grade stainless steel (1.4571/316Ti)	E10028
	Lock nuts M30 x 1.5, high-grade stainless steel (1.4571/316Ti)	E10031
	Mounting set, free-standing M8 Clamp mounting, Ø 12.2 mm, high-grade stainless steel	E20861
	Mounting set, free-standing M10 Clamp mounting, Ø 18.5 mm, high-grade stainless steel	E20870
	Mounting set, free-standing M12 Clamp mounting, Ø 30.2 mm, high-grade stainless steel	E20874
	USB IO-Link master for parameter setting and analysis of units Supported communication protocols: IO-Link (4.8, 38.4 and 230 kBit/s)	E30390
	LR DEVICE (supplied on USB flash drive) Software for online and offline parameter setting of IO-Link sensors and actuators	QA0011
	IO-Link master with PROFINET interface	AL1100



Sensors for motion control

Multifunctional analogue display with IO-Link



Systems for evaluation of standard signals



Clearly legible display

Different modes configurable via IO-Link or setting menu

Change of display to red/yellow/green when set limit is exceeded or not reached

16-bit resolution

Additional functions such as tare, filter, averaging, signal combination

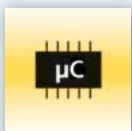

Analogue display 4.0

The new multifunctional display is more than just a display: It pre-processes digital signals in a decentralised manner and, if necessary, passes this information on to a higher-level controller. This intelligent feature makes it ideally suited for Industry 4.0 applications.

Versatile analogue value display

The intelligent display visualises different process parameters of sensors with an analogue output or of transmitters with a standard signal output. The freely adjustable scaling factors make it possible to convert and indicate the input signals as physical values (e.g. pressure, temperature or volumetric flow quantity).

If you use a pressure transmitter, for example, the volume of a tank can be displayed. It is also possible to offset input signals against each other, e.g. for differential pressure measurement.

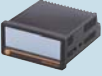
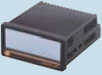

Type	Operating voltage [V]	Inputs analogue	Inputs programmable	Outputs analogue	Outputs transistor	Order no.
Multifunction display · touch display and clear text						
	115 / 230 AC; 24 DC	2	3	–	–	DX2041
	115 / 230 AC; 24 DC	2	3	–	4	DX2042
	115 / 230 AC; 24 DC	2	3	1	4	DX2043
	24 DC	2	3	–	–	DX2051
	24 DC	2	3	–	4	DX2052
	24 DC	2	3	1	4	DX2053
Multifunction display with IO-Link · touch display and clear text						
	115 / 230 AC; 24 DC	2	3	–	4	DX2045
	24 DC	2	3	–	4	DX2055

User-friendly handling

All settings can be made via a modern, resistive touch-screen interface. The display automatically changes from display mode to parameter setting mode. Alternatively, all settings can also be made via IO-Link. All parameters are displayed in clear text on the screen, enabling an easy and intuitive use. A password mechanism provides protection against manipulation.

Monitoring of limit values

The user can define up to four limit values. Up to four transistor outputs switch if a set limit is not reached or exceeded. In addition the IO-Link version sends the pre-processed information directly to the PLC.

Clear display

The states of the outputs are displayed and the colour of the display can be shown in red, yellow or green depending on the process value. With free text entry, units can be assigned to those values that are not already listed.

The basic functions:

- Single mode: one-channel operation (only input A)
- Dual mode: two-channel operation (input A and B separately)
- A a B: summation mode (input A + input B)
- A – B: differential mode (input A - input B)
- A d B: dividing mode (relation A : B)
- A m B: multiplication mode (product A x B)

Common technical data		
Operating voltage	[V DC] [V AC]	18...30 115 / 230
Current consumption (DC)		approx. 100 mA (without load)
Sensor supply (DC)	[V DC] Output current	U _B -1 V max. 250 mA
Current consumption (AC)		approx. 3 VA (without load)
Sensor supply (AC)	[V DC] Output current	approx. 24 V DC (± 15 %) 150 mA to 45 °C, 80 mA from 45 °C
Analogue inputs		-10...+10 V, 0...20 mA / 4...20 mA
Control inputs	Format Frequency	HTL, PNP (10...30 V) max. 10 kHz
Analogue outputs (DX2043, DX2053)	Voltage output Current output Resolution Accuracy	-10...+10 V, 0...20 mA / 4...20 mA 16 Bit ± 0.1 %
Control outputs	Format / level Output current	5...30 V (depending on the voltage on Com+), PNP max. 200 mA (max. 150 mA at Com+ <10 V)
Display	Type Colour Handling	LCD (backlight) red/yellow/green (selectable) Touch screen (resistive)
Ambient temperature	[°C]	-20...45/60
Dimensions (W x H x D)	[mm]	112 x 48 x 116

Dimensions

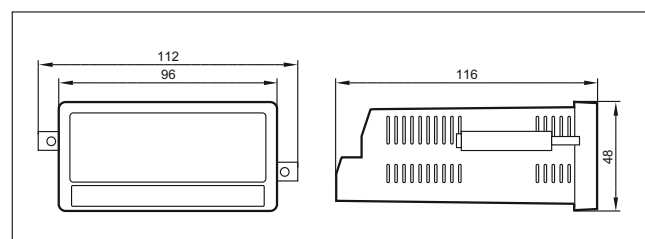



Sensors for motion control

Multifunctional display: speed, time, counter



Systems for pulse evaluation



Clearly legible display

Touch display and clear text for intuitive handling

Change of display to red/yellow/green when set limit is exceeded or not reached

4 optional switching outputs and/or analogue outputs (V or mA)

PNP, NPN or NAMUR inputs

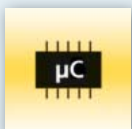

Digital display 4.0

The new multifunctional display is more than a simple display: It pre-processes digital signals in a decentralised manner and passes the information on to a higher-level controller if necessary. This intelligent feature makes it ideally suited for Industry 4.0 applications.

Versatile pulse evaluation

The multifunction display shows various measured values in industrial automation. It uses the principle of interval measurement to process input pulses. The scaling factor allows (rotational) speed and processing time, etc., to be calculated, displayed and converted into an analogue signal. Moreover, the unit is suitable for counting and timer tasks.



Type	Operating voltage [V]	Inputs pulse	Inputs programmable	Output analogue	Outputs transistor	Order no.
Multifunction display · touch display and clear text						
	115 / 230 AC 24 DC	2	3	–	–	DX2021
	115 / 230 AC 24 DC	2	3	V or mA	4	DX2022
	115 / 230 AC 24 DC	2	3	–	4	DX2023
	24 DC	2	3	–	–	DX2031
	24 DC	2	3	V or mA	4	DX2032
	24 DC	2	3	–	4	DX2033

User-friendly handling

All settings can be made via a modern, resistive touch-screen interface. The display automatically changes from display mode to parameter setting mode.

All parameters are displayed in clear text on the screen, enabling an easy and intuitive use.

With free text entry, units can be assigned to those values that are not already listed. A password mechanism provides protection against manipulation.

Monitoring of limit values

The user can define up to four limit values. Up to four transistor outputs switch if a set limit is not reached or exceeded.

The states of the outputs are displayed and the colour of the display can be shown in red, yellow or green depending on the process value.

Useful additional function:

In addition to the digital inputs for signal pre-processing the display has another 3 configurable digital inputs to initiate different actions.

There are functions such as freezing the current value or resetting the min. / max. values.

The basic functions:

Speed: Indication of rotational speed (RPM), operation as tachometer or for frequency measurement.

Process time: Operation as baking time or processing time display (reciprocal rotational speed).

Timer: Operation as stop watch.

Start and stop functions are freely configurable.

Counter: Operation as position display, pulse, totalisator, differential, up or down counter.

Velocity: Speed indication from operating time measurement. Input A serves as start input and input B as stop input.

Common technical data

Operating voltage	[V DC] [V AC]	18...30 115 / 230
Current consumption (DC)		approx. 100 mA (without load)
Sensor supply (DC)	[V DC] Output current	U _B -1 V max. 250 mA
Current consumption (AC)		approx. 3 VA (without load)
Sensor supply (AC)	[V DC] Output current	approx. 24 V DC (± 15 %) 150 mA to 45 °C, 80 mA from 45 °C
Incremental inputs	Usage Format Frequency	PNP, NPN, Namur encoders and sensors HTL (10...30 V) max. 250 kHz
Control inputs	Format Frequency	HTL, PNP (10...30 V) max. 10 kHz
Analogue output (only DX2032, DX2022)	Voltage output Current output Resolution Accuracy	-10...10 V 0...20 mA / 4...20 mA 16 bits ± 0.1 %
Control outputs (DX2032, DX2033, DX2022, DX2023)	Format / level Output current	5...30 V (depending on the voltage on Com+), PNP max. 200 mA (max. 150 mA at Com+ <10 V)
Display	Type Colour Handling	LCD (backlight) red/yellow/green (selectable) touch screen (resistive)
Ambient temperature	[°C]	-20...45/60
Dimensions (W x H x D)	[mm]	112 x 48 x 116

Dimensions

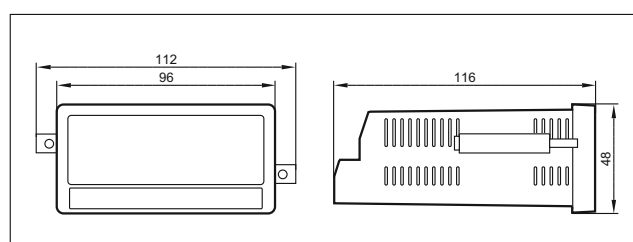



Augmented reality: mobile 3D smart camera with overlay function



Camera systems for
mobile machines



3D sensor system with integrated 2D camera and overlay function

Indication of warnings and obstacles in the live view

Signal processing in the sensor, no external process unit required

Easy adjustment via ifm Vision Assistant

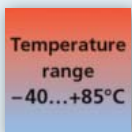
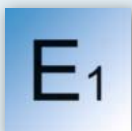

Augmented reality

The 3D smart camera is the first 3D sensor system with integrated 2D camera. The video image is displayed with real-time graphics, symbols or texts. They are either triggered by the integrated driver assistance system or by the machine controller via CAN. Thus, the user can always see all relevant warnings or other relevant details in the camera image.

Integrated assistance system

In addition to the 3D and 2D image sensor a complete evaluation system is integrated in the sensor system. This system provides an independent assistance system for collision avoidance for the user. Set-up only requires just a few steps using the ifm Vision Assistant PC software. In addition to the analogue video output the smart camera also features a CAN and Ethernet UDP interface. The system can use this interface to supply warnings in critical situations autonomously.



Resolution [pixels]	Angle of aperture horizontal x vertical [°]	Angle of aperture 2D [°]	Illumination	Max. sampling rate [Hz]	Order no.
PMD 3D sensor · Type O3M · M12 connector					
64 x 16	70 x 23	90	Ext. illumination required (O3M950)	25/33/50	O3M251
64 x 16	95 x 23	120	Ext. illumination required (O3M960)	25/33/50	O3M261

Connection technology

Type	Description	Order no.
	MCI cable, connection sensor / system illumination unit, 0,25 m	E3M120
	MCI cable, connection sensor / system illumination unit, 1 m	E3M121
	MCI cable, connection sensor / system illumination unit, 2 m	E3M122
	MCI cable, connection sensor / system illumination unit, 3 m	E3M123
	M12 video connection cable, connection sensor / display PDM360, 5 m	E3M151
	M12 video connection cable, connection sensor / display PDM360, 11 m	E3M152
	M12 video connection cable, connection sensor / display PDM360, 16 m	E3M153
	M12 video connection cable, connection sensor / display PDM360, 21 m	E3M154
	M12 video extension cable, 5 m	E3M159
	M12 video adapter cable / Cinch plug, for connection of a video grabber, 1 m	E3M160
	M12 socket, voltage supply system illumination unit, 2 m, PUR cable, 4 poles	E3M131
	M12 socket, voltage supply system illumination unit, 5 m, PUR cable, 4 poles	E3M132
	M12 socket, voltage supply system illumination unit, 10 m, PUR cable, 4 poles	E3M133
	Ethernet, cross-over patch cable, 2 m, PVC cable, M12 / RJ45	E11898
	Ethernet, cross-over patch cable, 10 m, PVC cable, M12 / RJ45	E12204
	Ethernet, cross-over patch cable, 20 m, PVC cable, M12 / RJ45	E12205
	CAN jumper, screened, 2 m, PUR cable, M12 plug / M12 socket	E11593
	CAN jumper, screened, 5 m, PUR cable, M12 plug / M12 socket	E11594
	CAN jumper, screened, 10 m, PUR cable, M12 plug / M12 socket	E11595

Further technical data O3M251

Type of sensor	1/4" 4:3 VGA CMOS image sensor Color
PAL resolution [pixels]	640 x 480
Housing material	diecast aluminium
Connection	M12 connector
Protection rating, protection class	IP 67 / IP 69K, III
Operating voltage [V DC]	9...32
Current consumption sensor [mA]	< 500
Current consumption system illumination unit [A]	< 5
Ambient temperature [°C]	-40...85
Storage temperature [°C]	-40...105
Interfaces	1x CAN, 1 x fast Ethernet, 1x PAL
Supported CAN protocols	CANopen, SAE J 1939
Standards and tests (extract)	CE, E1 (UN-ECE R10)

Accessories

Type	Description	Order no.
	IR system illumination unit (850 nm) for mobile 3D sensors, angle of aperture 70 x 23	O3M950
	IR system illumination unit (850 nm) for mobile 3D sensors, angle of aperture 95 x 32	O3M960
	CAN/RS232 USB interface CANfox	EC2112
	Adapter cable set for CANfox	EC2114
	Operating software for vision sensors	E3D300
	U-shaped bracket, suitable for sensor or illumination unit	E3M102
	Weather protective cover (the article E3M100 or E3M102 is required for installation)	E3M101



Industrial imaging

Robust 7.0" TFT LCD monitor for mobile machines



Monitor for camera systems



Universal display of analogue video signals

Water/weather-proof housing with protection rating IP 66 / IP 67

PAL/NTSC video system

Direct connection of up to 2 or 4 cameras via video switch

Supply voltage of 18...30 V DC

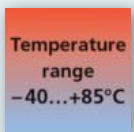

Plug and play monitor for a better overview

For most mobile machines, a 360° view or at least the surveillance of blind spots would be impossible without camera monitor systems. Besides the robust O2M2 and O3M2 cameras, ifm now offers suitable plug and play monitors.

Optimised for mobile machines

The water-proof monitor series automatically adapts to different ambient light situations. The WVGA display features automatic brightness control with adjustable day/night switching. All settings can be made via the comprehensive service menu, e.g. automatic camera switching when the driver indicates or goes to reverse.

In combination with the smart O3M2 3D camera, the monitor can also be used to indicate obstacles in the path or show vehicle information (supplied by the CAN bus).











Features and benefits

Easy-to-use

The preconfigured system only requires supply voltage to be ready for use. The cameras are connected via M16 connectors, they are automatically recognised and immediately provide an image to the monitor. No configuration is required for standard operation.

Accessories

Type	Description	Order no.
Mounting accessories		
	Anti-glare frame large, elastic.	E2M233
	Anti-glare frame small (supplied with each monitor)	E2M234
	Video switch for connection of 3 further cameras	E2M235
	RAM mount mounting bracket 90 mm	E2M236
	RAM mount mounting bracket 144 mm	E2M237
	RAM mount mounting plate	E2M238
	Monitor bracket – complete set	E2M239
Analogue camera, PAL video output, lens heating 0.5 m connection cable with M16 connector		
	Angle of aperture 78°	O2M200
	Angle of aperture 78°, integrated mirror function	O2M201
	Angle of aperture 115°	O2M202
	Angle of aperture 115°, integrated mirror function	O2M203
3D smart camera with PAL video output M12 connector		
	Angle of aperture 2D: 90° / 3D: 70° x 23°	O3M251*
	Angle of aperture 2D: 120° / 3D: 95° x 32°	O3M261*
Jumper cables		
	5 m black, PVC cable, M16 connector / M16 socket	E2M203
	11 m black, PVC cable, M16 connector / M16 socket	E2M204
	16 m black, PVC cable, M16 connector / M16 socket	E2M205
	21 m black, PVC cable, M16 connector / M16 socket	E2M206
	Adapter cable for the connection of O3M2 3D cameras	E3M161



Robust design

The monitor series is made of aluminium and impact and weather resistant plastic. They are suitable for use in the cabins of trucks, cranes and fork-lift trucks as well as in the open cabins of construction machines. All systems feature an undervoltage, overvoltage and reverse polarity protection.

Vast setting options

The service menu offers many setting options for an ideal integration in mobile machines. Via the digital inputs, the cameras can for example be activated automatically. The background illumination can be adjusted freely and automatically to the ambient light via a photoelectric sensor. Brightness and contrast values can be set manually. Optimum visibility in dark environments via a red or blue night mode. Additionally, it is possible to display horizontal and vertical reference lines or a grid, e.g. as a positioning or parking assistance.

The products

Type	Description	Order no.
7.0" TFT LCD monitor with LED backlight, resolution: WVGA 800 x RGB x 480		
	Direct connection of an O2M2 or O3M2 smart camera. 1 video input	E2M231
	Direct connection of O2M2 cameras and / or O3M2 smart cameras. 2 video inputs	E2M232

Further technical data

Housing	Aluminium, impact resistant plastic, black
Device connection	M16 connector, open cable end
Protection	IP 66, IP 67
Operating voltage	[V DC] 18...30
Power consumption	[W] Max. 12
Temperature range operation/storage	[°C] -40...85 / -40...125
Lifetime LED	30,000 hrs
Background illumination	600 cd/m ²
Video input	PAL 50 Hz / NTSC 60 Hz
Number of video inputs with E2M235 video switch	3 (E2M231) 4 (E2M232)
Digital inputs for camera switching via connection cable	5
Standards and tests	CE

* Further accessories required. See www.o3m.ifm



Industrial imaging



3D sensors for flexible automation of robot grippers

3D sensors



Position indication of stationary or moving objects

Various shapes can be detected

Several object positions can be read simultaneously

For industrial robots and lightweight collaborative robots

Suitable for hydraulic, pneumatic and electrical grippers



Gripper navigation

The 3D sensor detects the object position, even when objects are moving, and transmits it to the robot control, which controls the gripper. The system can detect rectangular, round and irregular shapes and transmit not only the position of their centre of gravity, but also their number and dimensions to the controller.

Typical objects are boxes, cardboard packages, buckets, kegs, cans, bags, wheels or luggage. Automated gripper systems increase the productivity of many applications, as they carry out monotonous manufacturing steps more quickly and evenly than a human.

In addition, monotonous movements with heavy objects are bad for workers' health and lead to frequent absences.

When robots take over heavy physical work, this increases machine uptime and releases human workers for tasks for which they are better suited.



Type of sensor	Material housing	Material front pane / LED window	Protection rating, protection class	Angle of aperture [°]	Max. field of view size [m]	Order no.
PMD 3D sensors · Type O3D · M12 connector						
PMD 3D ToF chip	aluminium	gorilla glass / polyamide	IP 65, IP67 / III	40 x 30	2.61 x 3.47	O3D300
PMD 3D ToF chip	aluminium	gorilla glass / polyamide	IP 65, IP67 / III	60 x 45	3.75 x 5.00	O3D302
PMD 3D ToF chip	stainless steel	PMMA / polyamide	IP 65, IP 67, IP 69K / III	40 x 30	2.61 x 3.47	O3D310
PMD 3D ToF chip	stainless steel	PMMA / polyamide	IP 65, IP 67, IP 69K / III	60 x 45	3.75 x 5.00	O3D312

Technical data gripper systems	
Operating distance [m]	0.2...6
Object types	any
Min. object size [mm]	20 x 20 x 20 (depending on the operating distance and the object reflectivity)
Typical accuracy object position [mm]	± 10 (rectangular objects)
Typical accuracy for angle of rotation [°]	± 1 (rectangular objects)
Object speed [m/s]	< 0.2
Sampling rate / switching frequency [Hz]	2 (for one object to be measured)
Maximum number of objects	20

Further technical data	
Operating voltage [V DC]	20.4...28.8
Current consumption [mA]	< 2400 peak current pulsed; typ. mean value 420
Current rating (per switching output) [mA]	100
Short-circuit protection, pulsed	•
Overload protection	•
Ambient temperature [°C]	-10...50
Real chip resolution	25,000 / 100,000
Resulting resolution	176 x 132 pixels
Function display	LED 2 x yellow, 2 x green
Illumination	850 nm, infrared
Immunity to extraneous light [klx]	8 (up to 100 klx possible with reduced measuring accuracy and repeatability)
Trigger	external; 24 V PNP/NPN according to IEC 61131-2 type 3
Switching inputs	2 (configurable), 24 V PNP/NPN according to IEC 61131-2 type 3
Switching outputs digital	3 (configurable), 24 V PNP/NPN, according to IEC 61131-2
Switching outputs analogue	1 (can be configured as current output 4...20 mA or voltage output 0...10 V)
Parameter setting interface Ethernet	10 Base-T / 100 Base-TX
Parameter setting options	via PC / notebook
Dimensions (H, W, D) [mm]	72 x 67.1 x 95

Accessories

Design	Description	Order no.
--------	-------------	-----------

Mounting accessories

	Mounting set for O3D	E3D301
	Cooling element	E3D302
	Double cooling element	E3D304
	Heat conductor	E3D303

Connection technology

	Ethernet, cross-over patch cable, 2 m, PVC cable, M12 / RJ45	E11898
	Ethernet, jumper cable, 2 m, PVC cable, M12 / M12	E21138
	Socket, M12, 2 m black, PUR cable, 8-pole	E11950

ifm – close to you!

For further technical details please visit: www.ifm.com
(04.2018)



Industrial imaging

Depalletising of uniform packages made easy

TOP PRODUCT



3D sensors



Depalletising of a complete layer or individual packages

Slip sheet detection

Calculation of the remaining items

Integrated collision avoidance

Automatic calibration of robot camera coordinates

Economic and ergonomic

IP 65
IP 67

High-grade stainless steel

Ethernet

EtherNet/IP

IP 69 K

PROFINET

Optimisation of logistic processes

The automatic depalletising of packages of the same size, e.g. cardboard boxes, crates, outer packaging or containers, optimises logistic processes by dynamic feeding.

The 3D sensor detects displaced loads and compensates for incorrect positioning with the depalletising system. Position indication allows fully automated depalletising of complete layers or individual packages, independent of the palletising pattern. Besides the data for robot control, the Ethernet process interface provides information for the material and warehouse management software.

Automated depalletising systems provide a clear increase in performance by means of economic tools and reduce the employees' load due to ergonomically optimised working environments.



Type of sensor	Material housing	Material front pane / LED window	Protection rating, protection class	Angle of aperture [°]	Max. field of view size [m]	Order no.
PMD 3D sensors · Type O3D · M12 connector						
PMD 3D ToF chip	Aluminium	Gorilla glass / polyamide	IP 65, IP67 / III	40 x 30	2.61 x 3.47	O3D300
PMD 3D ToF chip	Aluminium	Gorilla glass / polyamide	IP 65, IP67 / III	60 x 45	3.75 x 5.00	O3D302
PMD 3D ToF chip	Stainless steel	PMMA / polyamide	IP 65, IP 67, IP 69K / III	40 x 30	2.61 x 3.47	O3D310
PMD 3D ToF chip	Stainless steel	PMMA / polyamide	IP 65, IP 67, IP 69K / III	60 x 45	3.75 x 5.00	O3D312

Technical data depalletising systems		
Operating distance	[m]	0.5...6
Object types		Closed rectangular objects
Min. object size	[mm]	50 x 50 x 50 (at minimum operating distance)
Typical accuracy Object position	[mm]	± 15
Typical accuracy for angle of rotation	[°]	± 3
Sampling rate / switching frequency [Hz]		1

Further technical data		
Operating voltage	[V DC]	20.4...28.8
Current consumption	[mA]	< 2400 peak current pulsed; typ. mean value 420
Current rating (per switching output)	[mA]	100
Short-circuit protection, pulsed		•
Overload protection		•
Ambient temperature	[°C]	-10...50
Real chip resolution		25,000 / 100,000
Resulting resolution		176 x 132 pixels
Function display	LED	2 x yellow, 2 x green
Illumination		850 nm, infrared
Immunity to extraneous light	[klx]	8 (up to 100 klx possible with reduced measuring accuracy and repeatability)
Trigger		external; 24 V PNP/NPN according to IEC 61131-2 type 3
Switching inputs		2 (configurable), 24 V PNP/NPN according to IEC 61131-2 type 3
Switching outputs digital		3 (configurable), 24 V PNP/NPN, according to IEC 61131-2
Switching outputs analogue		1 (can be configured as current output 4...20 mA or voltage output 0...10 V)
Parameter setting interface Ethernet		10 Base-T / 100 Base-TX
Possible parameter settings		via PC / notebook
Dimensions (H, W, D)	[mm]	72 x 67.1 x 95

Accessories

Design	Description	Order no.
--------	-------------	-----------

Mounting accessories

	Mounting set for O3D	E3D301
	Dissipators	E3D302
	Double cooling element	E3D304
	Heat conductor	E3D303

Connection technology

	Ethernet, cross-over patch cable, 2 m, PVC cable, M12 / RJ45	E11898
	Ethernet, jumper cable, 2 m, PVC cable, M12 / M12	E21138
	Socket, M12, 2 m black, PUR cable, 8-pole	E11950



Process sensors

All at sea? Pressure, temperature, level and flow sensors with DNV-GL



Pressure, temperature, level and flow sensors



DNV-GL approval for applications on ships

Pressure transmitters, submersible pressure transmitters and sensors with display

Temperature transmitters

Flow sensor with programmable switching output

Sensors for point level detection

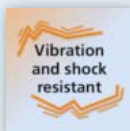

Reliable also under extreme conditions

New DNV-GL approval means ifm's tried-and-tested fluid sensors can now also be used in maritime applications. The approved components help the user to overcome obstacles in ship and plant approval.

The sensors are distinguished by their compact and robust design and are therefore ideal for demanding applications, for example in hydraulics. Besides, ifm offers a 5-year warranty.



Pressure transmitters

Measuring range relative pressure [bar]	P _{overload} max. [bar]	P _{burst} min. [bar]	Order no.	Order no.
Output function 4...20 mA, G 1/4			Out pin2	Out pin3
0...6 to 0...600	15...1200	200...2400	PT54xx	PT53xx
Output function 4...20 mA, 1/4 NPT			Out pin2	Out pin3
0...6 to 0...600	15...1200	200...2400	PT24xx	-

Pressure sensors with display

Measuring range relative pressure [bar]	P _{overload} max. [bar]	P _{burst} min. [bar]	Order no.	Order no.
2 x NO/NC or 1x NO/NC + analogue, IO-Link, FKM seal			G 1/4	G 1/4 A
0...0.25 to 0...600	6...800	30...2500	PN207x PN209x PN216x	PN25xx
2 x NO/NC or 1x NO/NC + analogue, IO-Link, FKM seal			1/4 NPT	1/4 NPT A
0...6 to 0...600	15...1200	200...2400	PN227x PN229x	PN26xx
2 x NO/NC or 1x NO/NC + analogue, IO-Link, EPDM seal, ceramic measuring cell			G 1/4	G 1/4 A
0...1 to 0...250	20...500	50...1200	PE20xx	PE25xx

Submersible pressure transmitters

Measuring range relative pressure [bar]	P _{overload} max. [bar]	P _{burst} min. [bar]	Order no.
Output function 4...20 mA, ATEX approval			
0...0.25 to 0...1	2	2.4	PS3xxA

Dimensions

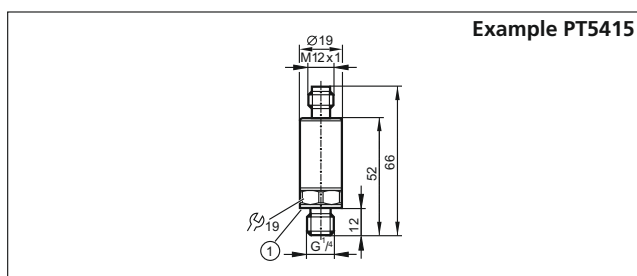

1) Seal

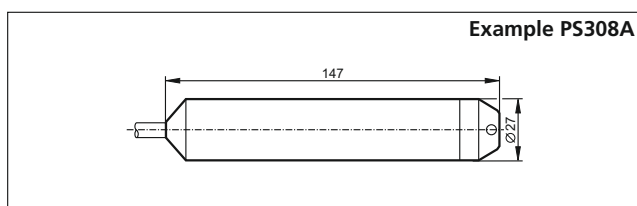

Flow sensors

Setting range [cm/s]	Nominal length [mm]	Pressure rating [bar]	Order no.
Output function 2 x NO / NC PNP, M18 x 1.5			
3...300	45	300	SI0521

Temperature transmitters

Nominal length [mm]	Process connection	Order no. Factory setting	
Output function 4...20 mA, scalable, IO-Link		-50...150 °C	0...100 °C
30...150	G 1/2	TA24x5	TA24x7
25...150	G 1/4	TA21x5	-
Output function 4...20 mA, scalable, IO-Link		0...300 °F	
30...150	1/2 NPT	TA23x3	-
25...150	1/4 NPT	TA26x3	-

Level sensors

Process connection	Probe length [mm]	Order no.	
2 x NO/NC, IO-Link		Water	Oil
G 1/2	12	LMC100	LMC110
G 1/2	21	LMC400	LMC410
1/2 NPT	34	LMC500	LMC510

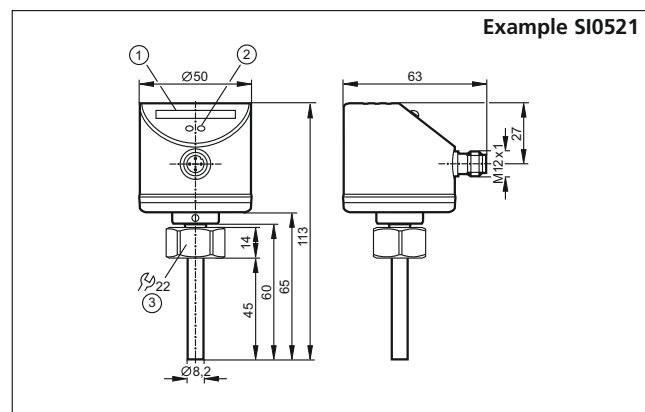

- 1) LED bar display
- 2) Set button
- 3) Tightening torque 25 Nm

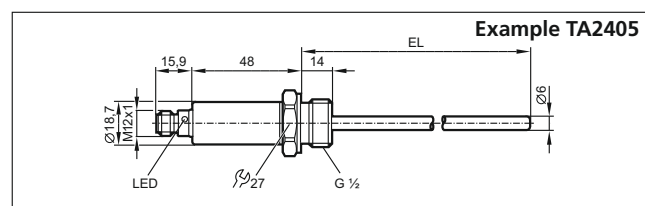



Process sensors

Process values from IO-Link sensors at a glance



IO-Link master display



Visualisation of all process values from the sensors connected to the master

Automatic search of the process values – plug & play

Your favourite view for four process values can be set

Setting of the IP address of the IO-Link master

Supports IO-Link masters from ifm with 4 and 8 ports

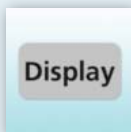
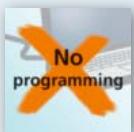

Process values at a glance

The display is an excellent choice for displaying process values for sensors which do not have a display, which are difficult to access or are not visible after installation caused by the application. This means that ideal measuring points can be used irrespective of the visualisation.

Plug & play

The E30443 IO-Link master display is simply connected to one port of an ifm IO-Link master with 4 or 8 ports. The display detects sensors which are connected to the same master and automatically indicates the main process value of the first four ports.

Each sensor and its process values can also be visualised individually by pushing a button. Furthermore a favourite view with the requested process values can be created. In addition the user can easily and reliably configure the display and the IP address of the master.



Dimensions

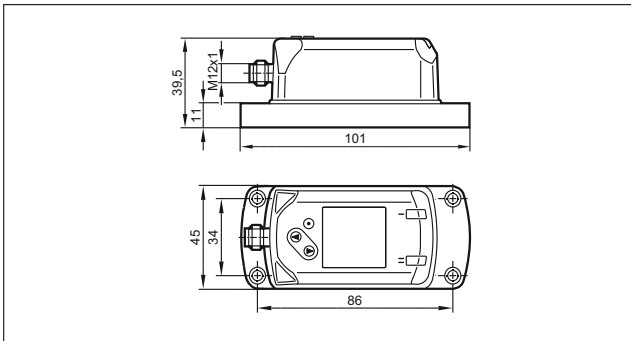

Wiring diagram

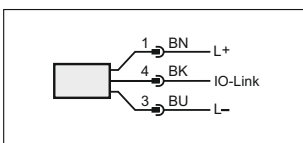

E30443

Accessories

Type	Description	Order no.
	DIN rail clip, PA; stainless steel (304 / 1.4567)	E30429

Connection technology

Type	Description	Order no.
	Jumper, M12, 1 m, black, PUR cable	EVC042
	Jumper, M12, 2 m, black, PUR cable	EVC043
	Jumper, M12, 3 m, black, PUR cable	EVC102
	Jumper, M12, 5 m, black, PUR cable	EVC044
	Jumper, M12, 10 m, black, PUR cable	EVC493

Resolution pixels	Display type	Display illumination	Order no.
-------------------	--------------	----------------------	-----------

IO-Link master display · Connection to master
Display shows all process values from the sensors connected to the master

128 x 128	1.44" TFT	LED	E30443
-----------	-----------	-----	---------------

Other available IO-Link displays

Resolution pixels	Display type	Display illumination	Order no.
-------------------	--------------	----------------------	-----------

IO-Link display · Connection to master
Assignment of the values displayed by the controller

128 x 128	1.44" TFT	LED	E30391
-----------	-----------	-----	---------------

IO-Link inline display · Connection between master and sensor
Visualisation of the values of the connected sensor

128 x 128	1.44" TFT	LED	E30430
-----------	-----------	-----	---------------

Technical data

IO-Link displays		
Operating voltage	[V DC]	18...30
Current consumption	[mA]	< 47
Protection rating/ protection class		IP 65, IP67 / III
Reverse polarity protection		•
Communication interface		
IO-Link device		
Type of transmission		COM2 (38.4 kbaud)
IO-Link revision		1.1
SDCI standard		IEC 61131-9
Ambient temperature	[°C]	0...60
EMC		EN 61000-6-2 EN 61000-6-4
Shock resistance	[g]	20 (11 ms)
Vibration resistance	[g]	20 (10...50 Hz)
Housing materials		stainless steel (303 / 1.4305); PC; PBT-GF 30; PPS; PA 6.6; FKM
Connection		M12 connection



Process sensors



Pressure transmitter for hygienic applications with IO-Link and 4...20 mA



Pressure sensors



0.2 % accuracy

Overload-resistant ceramic-capacitive measuring cell with good long-term stability

Factory certificate for download free of charge

Rear hexagonal nut for easy installation in tanks with double walls and blind fittings.

Zero point calibration via teach button or IO-Link



High accuracy

The new PM type pressure transmitter has a total accuracy of 0.2 %. Furthermore, temperature compensation with fast temperature changes (e.g. in CIP/SIP processes) has been improved considerably. The sensor is therefore suitable for all common food applications.

Free factory certificate

For every PM pressure sensor a factory certificate can be downloaded free at www.factory-certificate.ifm. This allows easy access even after the sensor has been bought.

Flexible fitting

ifm offers all common process connections (e.g. welding adapter, Tri Clamp, Varivent, etc.) as accessories for the adapter threads G1 sealing cone and G1 Aseptoflex Vario of the PM pressure sensor.



Factory setting Measuring range [bar]	Measuring range Relative pressure [bar]	Poverload max. [bar]	Order no.
G1 sealing cone, 4...20 mA, IO-Link			
0...100	-1...100	200	PM1602
0...25	-1...25	100	PM1603
0...16	-1...16	75	PM1614
0...10	-1...10	50	PM1604
0...6	-1...6	30	PM1615
0...4	-1...4	30	PM1605
0...2.5	-0.125...2.5	20	PM1606
0...1.6	-0.1...1.6	15	PM1617
0...1	-0.05...1	10	PM1607
-1...1	-1...1	10	PM1609
0...0.25	-0.0125...0.25	10	PM1608
0...0.1	-0.005...0.1	4	PM1689
Aseptoflex Vario, 4...20 mA, IO-Link			
0...25	-1...25	100	PM1703
0...16	-1...16	75	PM1714
0...10	-1...10	50	PM1704
0...6	-1...6	30	PM1715
0...4	-1...4	30	PM1705
0...2.5	-0.125...2.5	20	PM1706
0...1.6	-0.1...1.6	15	PM1717
0...1	-0.05...1	10	PM1707
-1...1	-1...1	10	PM1709
0...0.25	-0.0125...0.25	10	PM1708
0...0.1	-0.005...0.1	4	PM1789

Connection technology

Type	Description	Order no.
	Socket, M12, 4-pole 5 m, grey, MPPE cable	EVF001
	Socket, M12, 4-pole 10 m, grey, MPPE cable	EVF002
	Socket, M12, 4-pole 5 m, grey, MPPE cable	EVF004
	Socket, M12, 4-pole 10 m, grey, MPPE cable	EVF005

Dimensions

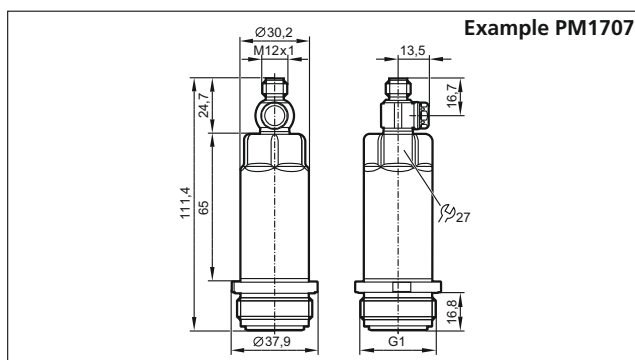

Common technical data			
Operating voltage	[V DC]	18...30	
Reverse polarity protection		•	
Step response time	[ms]	30 (2L) / 7 (3L)	
Analogue output			
Accuracy / deviation (in % of the span)		PM1x89	PM1602
Deviation of the characteristics (to DIN EN 61298-2) incl. non-linearity for limit value setting (LS), hysteresis, non-repeatability	< ± 0.2	< ± 0.5	< ± 0.5
Repeatability	< ± 0.1	< ± 0.1	< ± 0.1
Long-term stability	< ± 0.1	< ± 0.1	< ± 0.1
Temperature coefficient (TEMPCO) in the temperature range 0...70 °C (in % of the span per 10 K)			
TEMPCO of zero	< ± 0.05	< ± 0.1	< ± 0.2
TEMPCO of the span	< ± 0.15	< ± 0.2	< ± 0.2
Medium temperature	[°C]	-25...125 (150 max. 1h)	
Protection		IP 67 / IP 68 / IP 69K	
Materials in contact with the medium		Ceramics 99.9 %, PTFE, stainless steel (1.4435 / 316L)	
Communication interface		IO-Link 1.1 COM2 slave; 38.4 kbaud	

Accessories

Type	Description	Order no.
	Teach button, stainless steel (1.4404 / 316L); PA; FFKM; PBT	E30425
	Aseptoflex Vario adapter Clamp 1-1.5" with O-ring, ISO 2852, stainless steel (1.4435 / 316L)	E33201
	Welding adapter Ø 60 mm with O-ring, stainless steel (1.4435 / 316L)	E30150
	LR DEVICE (supplied on USB flash drive) Software for online and offline parameter setting of IO-Link sensors and actuators	QA0011
	USB IO-Link master for parameter setting and analysis of units Supported communication protocols: IO-Link (4.8, 38.4 and 230 kBit/s)	E30390



Process sensors

Pressure sensors for water-based media



Pressure sensors



Wetted parts: ceramics, EPDM and high-grade stainless steel

DNV-GL approval for maritime applications

Robust ceramic measuring cell

Rotatable process connection

Programmable red/green display

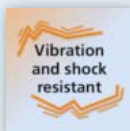

Applications

Based on the tried-and-tested pressure sensors, ifm presents a version for special applications. The new PE2 family of pressure sensors are ideally suited for water-based media due to the materials used for their wetted parts (ceramics, EPDM, stainless steel).

Further applications are ammonia circuits in refrigerating technology and monitoring of cleaning agents and other secondary processes in the food industry. The PE2 family is not suitable for oils and oil-based media due to its EPDM cell sealing.

Robust measuring cell

The ceramic measuring cell ensures excellent overload protection even in case of cavitation, and a high resistance to media.

Dimensions

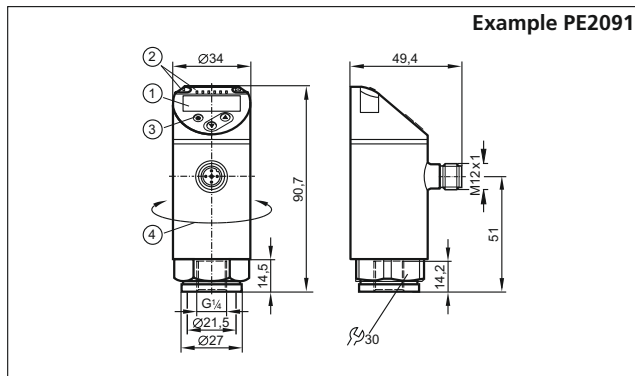

- 1) 4-digit alphanumeric display / alternating indication (red and green)
- 2) LEDs (display unit / switching status)
- 3) programming button
- 4) upper part of the housing can be rotated by 345°

Wiring diagram

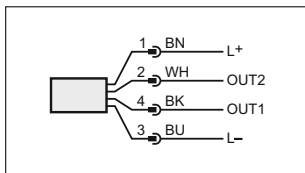

OUT1: switching output or IO-Link
 OUT2: switching output
 Colours to DIN EN 60947-5-6

Accessories

Design	Description	Order no.
	EPDM seal for external thread	E30442
	Angle bracket	E30421
	Protective cover	E30420
	Ventilation cover	E30432
	USB IO-Link master for parameter setting and analysis of units Supported communication protocols: IO-Link (4.8, 38.4 and 230 Kbits/s)	E30390
	LR DEVICE (supplied on USB flash drive) Software for online and offline parameter setting of IO-Link sensors and actuators	QA0011

Measuring range Relative pressure [bar]	Poverload max. [bar]	Pburst min. [bar]	Order no.	Order no.
Output function 2 x NO/NC or 1x NO/NC + analogue, IO-Link			G 1/4	G 1/4 male
0...250	500	1200	PE2091	PE2591
0...100	300	650	PE2092	PE2592
0...25	150	350	PE2093	PE2593
0...10	75	150	PE2094	PE2594
0...2.5	20	50	PE2096	PE2596
-1...1	20	50	PE2099	PE2599

Common technical data

Operating voltage	[V DC]	18...30
Current rating	[mA]	250
Accuracy / deviation (in % of the span) turn down 1:1		
Switch point accuracy		< ± 0.4
Linearity error		< ± 0.25 (BFSL) < ± 0.5 (LS)
Repeatability		< ± 0.1
Long-term stability		< ± 0.05
Temperature coefficient (TEMPCO) in the temperature range -25...80 °C (in % of the span per 10 K)		
Greatest TEMPCO of zero		< ± 0.2
Greatest TEMPCO of the span		< ± 0.2
Switching frequency	[Hz]	≤ 500
Medium temperature	[°C]	-25...80
Shock resistance	[g]	50
Vibration resistance	[g]	20
Materials in contact with the medium		high-grade stainless steel (1.4404 / 316L) Al ₂ O ₃ (ceramics), EPDM
Communication interface		IO-Link 1.1 COM2 slave; 38.4 kbaud

Connection technology

Design	Description	Order no.
	Socket, M12, 2 m black, PUR cable	EVC001
	Socket, M12, 5 m black, PUR cable	EVC002
	Socket, M12, 2 m black, PUR cable	EVC004
	Socket, M12, 5 m black, PUR cable	EVC005



Process sensors

Pressure transmitters with DEUTSCH, AMP or M12 connector for mobile applications



Pressure sensors



Compact design (AF19) with process connection G 1/4 male

**Fast reaction:
2 milliseconds response time**

**Measuring accuracy $< \pm 0.8 \%$,
repeatability $< \pm 0.05 \%$**

**Easy connection via DEUTSCH,
AMP or M12 connector**

**Available output functions:
4...20 mA, 0...10 V and 0.5...4.5 V**



Vibration
and shock
resistant



IP 67
IP 69 K

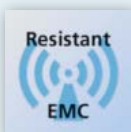

Resistant
EMC



Miniaturisation for mobile applications

The connectors of the new PT/PU pressure sensors allow fast and easy installation in mobile machines.

The sensors also feature a thin-film measuring cell directly welded with the process connection.

This technology guarantees high accuracy in a very compact housing with only 19 mm across flats at a cost-optimised price/performance ratio.

Applications

The PT/PU type sensors are suited for mobile applications and especially for hydraulic and pneumatic applications with high operating pressure.

The high vibration and shock resistance, the high protection rating, the excellent EMC resistance and the E1 conformity make the PT/PU sensors particularly suitable for use in mobile machines.



Measuring range relative pressure [bar]	P _{overload} max. [bar]	P _{burst} min. [bar]	Order no.	Order no.	Order no.
Output function 4...20 mA,			M12 connector	AMP connector	DEUTSCH connector
0...10	25	300	PT5504	PT5604	PT5704
0...25	65	600	PT5503	PT5603	PT5703
0...100	250	1000	PT5502	PT5602	PT5702
0...250	625	1200	PT5501	PT5601	PT5701
0...400	1000	1700	PT5500	PT5600	PT5700
0...600	1500	2400	PT5560	PT5660	PT5760
Output function 0...10 V			M12 connector	AMP connector	DEUTSCH connector
0...10	25	300	–	PU5604	PU5704
0...25	65	600	–	PU5603	PU5703
0...100	250	1000	–	PU5602	PU5702
0...250	625	1200	–	PU5601	PU5701
0...400	1000	1700	–	PU5600	PU5700
0...600	1500	2400	–	PU5660	PU5760
Output function 0.5...4.5 V fixed			M12 connector	AMP connector	DEUTSCH connector
0...10	25	300	PU8504	–	PU8704
0...25	65	600	PU8503	–	PU8703
0...40	100	800	–	–	PU8743
0...60	150	900	PU8523	–	–
0...100	250	1000	PU8502	–	PU8702
0...160	400	1100	–	–	PU8712
0...250	625	1200	PU8501	–	PU8701
0...400	1000	1700	PU8500	–	PU8700
0...600	1500	2400	PU8560	–	PU8760

Dimensions

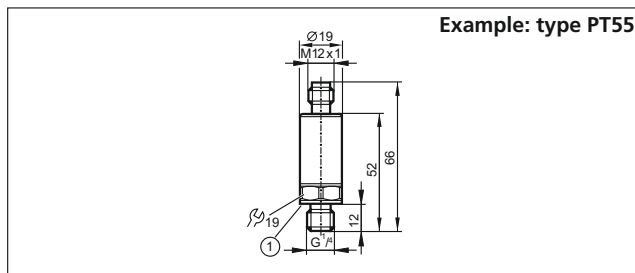

1) HNBR seal / DIN 3869

Accessories

Type	Description	Order no.
	Adapters; G 1/4 - G 1/2, high-grade stainless steel (316Ti/1.4571)	E30135

Common technical data

Operating voltage	PT [V DC] PU [V DC]	8...32 16...32
Reverse polarity protection		•
Accuracy / deviation (in % of the span)		< ± 0.8
Linearity error		< ± 0.25 BFS / < ± 0.5 LS
Linearity		< ± 0.25 BFS / < ± 0.5 LS
Medium temperature	[°C]	-40...125
Protection		IP 67 / IP 69K
Materials wetted parts		1.4542 (17-4 PH / 630), characteristics similar to stainless steel (e.g. 304/1.4301) but higher strength
Step response time	[ms]	2
Restrictor		•
EMC		Compliant with UN-ECE10 Rev. 4 ISO 11452: 100 V/m EN61326



Process sensors



Calorimetric flow meter for liquids and gases



Flow sensors / flow meters



Optimised for water, oils, glycol and air

Fast response time and integrated temperature measurement

Red/green colour change for process values

Internal pipe diameter selectable from 15...400 mm

The process connection can be rotated for optimum alignment



Measurement technique

The SA volumetric flow sensor operates using the calorimetric measuring principle. Measuring elements as well as a heat source are located on the measuring tip. The physical effect that a flowing medium absorbs heat energy and conducts it away is used. The resulting temperature change is an indication of flow.

Device function

The new SA-type sensor has been designed to detect and measure flow and temperature even in large internal pipe diameters up to 400 mm.

A serial number on the device enables unambiguous traceability.

Therefore it serves different applications. Switching outputs, analogue signals and IO-Link provide various options to further process the signals. That means that the user is best-equipped for Industry 4.0.



Type	Measuring range liquid / gaseous [cm/s]	Medium temperature [°C]	Pressure resistance [bar]	Response time [s]	Probe length [mm]	Order no.
------	---	-------------------------	---------------------------	-------------------	-------------------	-----------

Output signal: switching signal; analogue signal; frequency signal; IO-Link; (configurable)

M18	5...300 / 200...10000	-20...90	100	0.5	45	SA5000
Progressive ring	5...300 / 200...10000	-20...100	50	0.5	100	SA4100
Progressive ring	5...300 / 200...10000	-20...100	50	0.5	200	SA4300
G 1/2	5...300 / 200...10000	-20...90	100	0,5	19.2	SA2000

Output function 2 x analogue output 4...20 mA; (scalable)

G 1/2	5...300 / 200...10000	-20...90	100	0.5	19.2	SA2004
M18	5...300 / 200...10000	-20...90	100	0.5	45	SA5004
Progressive ring	5...300 / 200...10000	-20...100	50	0.5	100	SA4104
Progressive ring	5...300 / 200...10000	-20...100	50	0.5	200	SA4304

Accessories

Type	Description	Order no.
	USB IO-Link master for parameter setting and analysis of units Supported communication protocols: IO-Link (4.8, 38.4 and 230 Kbits/s)	E30390
	Progressive ring fitting G 1/2, flat seal	E40258
	Progressive ring fitting G 1/4, flat seal	E40259
	Progressive ring fitting G 3/4, flat seal	E40260
	Progressive ring fitting 1/2 NPT	E40261
	Progressive ring fitting 1/4 NPT	E40262
	Progressive ring fitting R 1/2	E40263
	Progressive ring fitting R 1/4	E40264
	Progressive ring fitting for SL mounting adapter	E40269
	Progressive ring fitting G 1/2, metal to metal seal	E40267
	Progressive ring fitting G 3/4, metal to metal seal	E40268
	Welding adapter for cutting ring	E40265
	Mounting clamp for progressive ring fitting E40269	E40048
	Protective cover for fluid sensors with M12 connector, polypropylene homopolymer	E30420
	Flow adapter	E40434

Common technical data

Type	SA
Operating voltage	[V] 18...30 DC
Current consumption	[mA] < 100
Current rating	[mA] 250
Accuracy temperature measurement	± 0.3 K
Accuracy flow measurement	± 7 % MW + 2 % VMR at reference conditions
Protection rating, protection class	IP 65 / IP 67, III
Housing materials	High grade stainless steel (1.4404/316L); PBT-GF 20; PBT-GF 30
Connection	M12 connector

Wiring

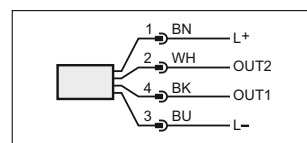

Connection technology

Type	Description	Order no.
	M12 socket, 2 m black, PUR cable	EVC001
	M12 socket, 5 m black, PUR cable	EVC002
	M12 socket, 2 m black, PUR cable	EVC004
	M12 socket, 5 m black, PUR cable	EVC005
	M12 socket, 2 m orange, PVC cable	EVT064
	M12 socket, 5 m orange, PVC cable	EVT001



Process sensors

New MID flow meter – now also for smallest quantities



Flow sensors / flow meters



Efficient flow meter for exact measurement of quantities of 0.005...3 l/min

High accuracy, repeatability and measurement dynamics

Suitable for conductive media from 20 μ S/cm

With totaliser function

4-digit alphanumeric LED display

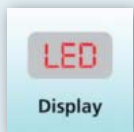

Magnetic-inductive flow meter

The new SM4 type flow meter operates according to Faraday's law of induction. The conductive medium flowing through a pipe in a magnetic field generates a voltage which is proportional to the flow velocity or volumetric flow quantity.

This voltage is tapped via electrodes and converted in the evaluation electronics. Its resistant materials mean the sensor is suitable for a multitude of media. A high protecting rating and a robust, compact housing distinguish the sensor in the field.



Design	Process connection	Measuring range [l/min]	Measuring accuracy [% of the final value]	Materials Seal	Pressure rating [bar]	Order no.
--------	--------------------	----------------------------	--	----------------	--------------------------	-----------

M12 connector · electrical design DC PNP / NPN · IO-Link

	G 1/4	0.005...3	± (2 % MV + 0.5 % VMR)	FKM	10	SM4000
	G 1/4	0.005...3	± (2 % MV + 0.5 % VMR)	EPDM	10	SM4100

Dimensions

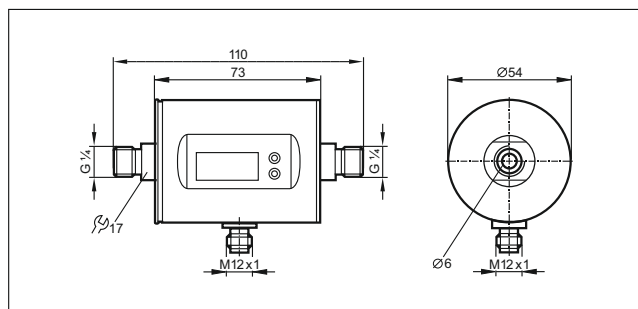

Wiring diagram

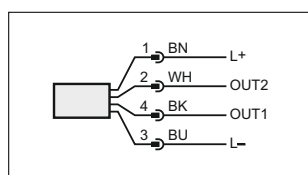

OUT1: 4 selection options

- switching output flow rate monitoring
- pulse output quantity meter
- signal output preset counter
- IO-Link

OUT2: 5 selection options

- switching output flow rate monitoring
- switching output temperature monitoring
- analogue output flow rate
- analogue output temperature
- input for counter reset

Colours to DIN EN 60947-5-6

Common technical data

Design SM		
Operating voltage	[V]	18...30 DC
Current consumption	[mA]	< 80
Current rating	[mA]	200
Protection rating, protection class		IP 67, III
Medium temperature	[°C]	0...60
Ambient temperature	[°C]	-10...60
Materials in contact with the medium		high-grade stainless steel (316L/1.4404); PEEK

Accessories

Type	Description	Order no.
	Adapter G 1/4 for G 1/2, high-grade stainless steel (316L/1.4404)	E40266
	Grounding clamp for units with M12 connector high-grade stainless steel (316L/1.4404)	E40234
	USB IO-Link master for parameter setting and analysis of units Supported communication protocols: IO-Link (4.8, 38.4 and 230 kBit/s)	E30390
	Memory plug, parameter memory for IO-Link sensors	E30398

Connection technology

Type	Description	Order no.
	Socket, M12, 2 m black, PUR cable	EVC001
	Socket, M12, 5 m black, PUR cable	EVC002
	Socket, M12, 2 m black, PUR cable	EVC004
	Socket, M12, 5 m black, PUR cable	EVC005
	Socket, M12, 2 m orange, PVC cable	EVT064
	Socket, M12, 5 m orange, PVC cable	EVT001



Process sensors



Maintenance-free level detection where other systems fail



Level sensors



Most reliable deposit suppression on the market

Flexible installation independent of the orientation

Shock and vibration resistant in a robust stainless steel housing

Factory set for simple plug & play

Differentiation of media by switch point setting

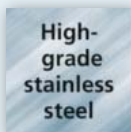
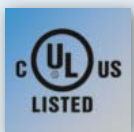

Level under control

The LMC family reliably monitors levels, e.g. in machine tools or wastewater management, or protects pumps from running dry. The option of a thread at the back permits variable installation depths and application-specific installation.

Versatile sensor for all media

The LMC sensor can be set to almost any liquid or viscous medium as well as to bulk materials. Permanent medium temperatures up to 100 °C or a heavy build-up are no problem.

The differentiation between two media is possible due to the two switching outputs which can be set independently. The parameters can be set with IO-Link and USB interface accessory E30390.



Process connection	Probe length [mm]	Feature	Medium temperature [°C]	Order no.	Order no.
Applications: water, hydrous media/oils, oil-based media M12 connector · output function NO/NC complementary				Water	Oil
G 1/2	12	–	-25...100	LMC100	LMC110
G 1/2	21	Thread at the back	-25...100	LMC400	LMC410
1/2 NPT	34	–	-25...100	LMC500	LMC510
1/2 NPT	40	–	-20...100	LMC502	–





Accessories

Type	Description	Order no.
	Welding adapter, G 1/2, Ø 26.4 mm	E43375
	Flat seal, 26.5 x 21.3 x 1.5 mm	E43376
	Welding mandrel for G 1/2 adapter, process connection G 1/2A	E43382
	Adapter, process connection G 1A	E43383
	Clamp adapter for LMC4x0 design, Ø 26.9 mm	E43384
	Cover, Ø 28 mm x 50 mm, pack quantity 5 pieces	E43385

Further technical data

Operating voltage	[V]	18...30 DC
Current rating	[mA]	100
Housing materials		Stainless steel (1.4404 / 316L), PEEK; PEI, FKM
Materials in contact with the medium		Stainless steel (1.4404 / 316L), PEEK (FPM only LMC502)
Protection		IP 68, IP 69K / III
Shock resistance	[g]	50
Vibration resistance	[g]	20
Ambient temperature	[°C]	-25...85
EMC closed tanks:		EN 6100-6-2:2005
open tanks:		EN 6100-6-3:2006 EN 6100-6-4:2006

Accessories IO-Link

Type	Description	Order no.
	USB IO-Link master for parameter setting and analysis of units Supported communication protocols: IO-Link (4.8, 38.4 and 230 Kbits/s)	E30390
	Memory plug, parameter memory for IO-Link sensors	E30398
	Jumper cable M12 plug / M12 socket, 0.3 m black, PUR cable	E12432
	LR DEVICE (supplied on USB flash drive) Software for online and offline parameter setting of IO-Link sensors and actuators	QA0011

Installation example LMC400:

Rear installation of the LMC400 sensor in the pipe permits variable installation depths.





Process sensors

Level and temperature values via one cable – thanks to IO-Link



Level sensors



Level and temperature measurement for water- and oil-based media

Integrated overflow prevention

Select level or temperature output

4 x switching outputs or 1 x analogue and 1 x switching output

Available in 3 lengths (264 mm, 472 mm and 728 mm)

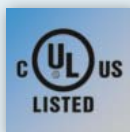

One sensor, two measured values

Typical applications are hydraulic power packs and machine tools. The advantage of this sensor: the combined level and temperature monitoring with only one unit reduces the number of sensors, mounting locations, stock-keeping and the installation complexity.

Advantage IO-Link

IO-Link transmits both parameters (level, temperature) as digital process values via one single cable. This means that only one input port is required on the controller. Simple and time-saving parameter setting via IO-Link.

Easy installation

Variable installation length for flexible installation.

Dimensions

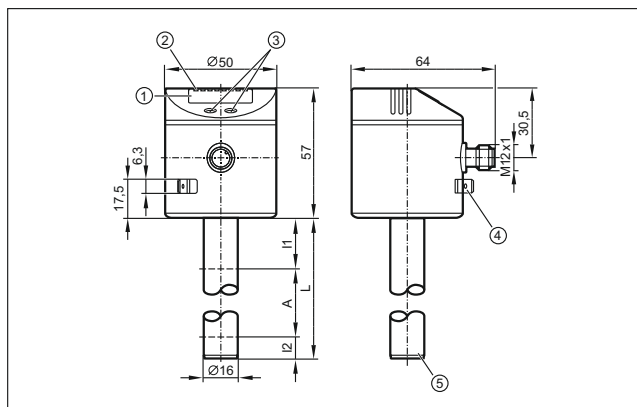

- 1) 4-digit alphanumeric display
- 2) Status LEDs
- 3) Programming buttons
- 4) Housing connection (flat-pin connector 6.3 mm to DIN 46244)
- 5) Position of the temperature measuring element

Accessories

Type	Description	Order no.
	Welding adapter, process connection \varnothing 50 mm	E43002
	Mounting adapter G 3/4, stainless steel	E43003
	Mounting adapter G 1, stainless steel	E43004
	Mounting adapter, 3/4" NPT, stainless steel	E43012
	Mounting adapter, 1" NPT, stainless steel	E43013
	Flange plate, 54-52 x 52 mm	E43007
	Flange plate, 73-90 mm	E43001
	Flange plate, 100-125 mm	E43005
	Flange plate, 65-80 mm	E43006
	Protective cover, PP (polypropylene)	E43910
	Climatic tube 264 mm, PPH; NBR	E43100*
	Climatic tube 472 mm, PPH; NBR	E43101*
	Climatic tube 728 mm, PPH; NBR	E43102*

* In case of installation in a climatic tube, the response time for the temperature increases.

Probe length L [mm]	Active zone A [mm]	Order no.
Output function 1 x NO / NC programmable, 1 x analogue output 4...20 mA or 0...10 V · IO-Link, 4-pole		
264	195	LT3022
472	390	LT3023
728	585	LT3024
Output function 4 x NO / NC programmable · IO-Link, 8-pole		
264	195	LT8022
472	390	LT8023
728	585	LT8024

Further technical data		
Operating voltage	[V DC]	18...30
Ambient temperature	[°C]	0...60
Process connection	[mm]	\varnothing 16
Protection rating, protection class		IP 67, III
Tank pressure	[bar]	0.5
Medium temperature	[°C]	0...70
(For medium temperatures > 35 °C the unit has to be installed in a climatic tube)	oil water	0...65 (depending on the installation length)

IO-Link accessories

Type	Description	Order no.
	USB IO-Link master for parameter setting and analysis of units Supported communication protocols: IO-Link (4.8, 38.4 and 230 Kbits/s)	E30390
	Memory plug, parameter memory for IO-Link sensors	E30398
	Jumper cable M12 plug / M12 socket, 0.3 m black, PUR cable	E12432
	LR DEVICE (supplied on USB flash drive) Software for online and offline parameter setting of IO-Link sensors and actuators	QA0011

Connection technology

Type	Description	Order no.
	Socket, M12, 8-pole, 2 m black, PUR cable	E11231
	Socket M12, 8-pole, 5 m black, PUR cable	E11232
	Socket, M12, 4-pole, 2 m black, PUR cable	EVC004
	Socket, M12, 4-pole, 5 m black, PUR cable	EVC005



Process sensors

LK – Level measurement without float in machine tools



Level sensors



No sticking of moving parts, e.g. floats

Level measurement for water/oil-based media

Integrated overflow prevention

4 x switching outputs, 2 x switching outputs or 1 x analogue and 1 x switching output

Available in 3 lengths (264 mm, 472 mm and 728 mm)

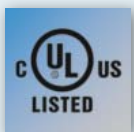

Capacitive level sensor

The LK capacitive level sensor evaluates the capacitance of the medium. This measuring principle requires no moving parts and is therefore not affected by foam and soiling in the medium.

The ideal sensor for industrial applications

The LK is suitable for water/oil-based media and can therefore be used in hydraulic and coolant tanks. Thanks to the integrated overflow prevention the workshop remains dry and the tanks to be monitored remain filled.





Besides conventional set-up via pushbuttons and display, the LK family can also be configured quickly and easily via IO-Link (e.g. USB interface). IO-Link continuously transmits the level, independently of the output function of the sensor.



Accessories

Type	Description	Order no.
	Welding adapter, process connection \varnothing 50 mm	E43002
	Mounting adapter, G 3/4, stainless steel	E43003
	Mounting adapter, G 1, stainless steel	E43004
	Mounting adapter, 3/4" NPT, stainless steel	E43012
	Mounting adapter, 1" NPT, stainless steel	E43013
	Flange plate, 54-52 x 52 mm	E43007
	Flange plate, 73-90 mm	E43001
	Flange plate, 100-125 mm	E43005
	Flange plate, 65-80 mm	E43006
	Protective cover, PP (polypropylene)	E43910
	Climatic tube 264 mm, PPH; NBR	E43100
	Climatic tube 472 mm, PPH; NBR	E43101
	Climatic tube 728 mm, PPH; NBR	E43102

Connection technology

Type	Description	Order no.
	Socket, M12, 8-pole, 2 m black, PUR cable	E11231
	Socket, M12, 8-pole, 5 m black, PUR cable	E11232
	Socket, M12, 4-pole, 2 m black, PUR cable	EVC004
	Socket, M12, 4-pole, 5 m black, PUR cable	EVC005





Probe length L [mm]	Special feature	Active zone A [mm]	Order no.
2 x switching outputs · IO-Link			
264	–	195	LK1022
472	–	390	LK1023
728	–	585	LK1024
264	Automatic medium detection	195	LK7022*
472		390	LK7023*
728		585	LK7024*
1 x switching output, 1 x analogue output 4...20 mA or 0...10 V · IO-Link			
264	–	195	LK3122
472	–	390	LK3123
728	–	585	LK3124
4 x switching outputs · IO-Link			
264	–	195	LK8122
472	–	390	LK8123
728	–	585	LK8124

* in preparation

Further technical data

Operating voltage	[V DC]	18...30
Ambient temperature	[°C]	0...60
Process connection	[mm]	\varnothing 16
Protection rating, protection class		IP 67, III
Tank pressure	[bar]	0.5
Medium temperature (for medium temperatures > 35 °C the unit has to be installed in water a climatic tube)	[°C]	0...70 0...65 (depending on the installation length)

IO-Link accessories

Type	Description	Order no.
	USB IO-Link master for parameter setting and analysis of units Supported communication protocols: IO-Link (4.8, 38.4 and 230 kBit/s)	E30390
	Memory plug, parameter memory for IO-Link sensors	E30398
	Jumper cable, M12 plug / M12 socket, 0.3 m black, PUR cable	E12432
	LR DEVICE (supplied on USB flash drive) Software for online and offline parameter setting of IO-Link sensors and actuators	QA0011



Process sensors



Infrared temperature sensor with IO-Link and LED pilot light



Temperature sensors



IO-Link, analogue output 4...20 mA and switching output, freely programmable

Adjustable for different target materials

Scratch-resistant precision lenses for minimum sensitivity to ambient light

LED pilot light for alignment and control

Simulation function: activated on the sensor or by external control signal



Non-contact temperature measurement

For the precise temperature measurement of particularly hot objects or objects which are difficult to access, e.g. in the steel, plastics or glass industries. The measured value is provided via the analogue output. In addition, a switching output and an IO-Link interface are provided.

Integrated LED pilot light

The pilot light shows the user the exact position and size of the measuring segment. The green light is visible very well even on glowing surfaces. Besides a low current consumption, the LED is distinguished by a virtually unlimited lifetime.

Batch-related programming

Thanks to the integrated IO-Link communication interface, the parameters can be dynamically adjusted to the application from the control room. Local parameter setting on the unit is not necessary, but can optionally be done via the buttons and the display.

Type	Measuring range [°C]	Wave length range [µm]	Measurement uncer- tainty (for e = 1, Tu = 23 °C)	LED pilot light	Response time [ms]	Order no.
M30, 1 x analogue, 1 x switching output, NO / NC programmable						
IR temperature sensor	0...1000	8...14	1 % of the measured value at least 2K	–	< 100	TW2000
IR temperature sensor	250...1600	1.0...1.7	0.5 % of measured value, min. 4 K	–	< 2	TW2001
IR temperature sensor	500...2500	0.78...1.06	0.3 % of measured value, min. 4 K	–	< 2	TW2002
IR temperature sensor with fibre optic and measuring head	300...1600	1.0...1.7	0.5 % of measured value, min. 4 K	–	< 2	TW2011
IR temperature sensor	0...1000	8...14	1 % of the measured value at least 2K	•	< 100	TW2100
IR temperature sensor	250...1600	1.0...1.7	0.5 % of measured value, min. 4 K	•	< 2	TW2101

Accessories

Type	Description	Order no.
	Air purge	E35063
	Cooling jacket	E35068
	Mounting bracket	E35065
	Protective tube	E35066
	Heat insulation	E35067
	USB IO-Link master for parameter setting and analysis of units Supported communication protocols: IO-Link (4.8, 38.4 and 230 kBit/s)	E30390
	LR DEVICE (supplied on USB flash drive) Software for online and offline parameter setting of IO-Link sensors and actuators	QA0011
	M12 socket, shielded, 2 m black, PUR cable	EVC547
	M12 socket, shielded, 5 m black, PUR cable	EVC548
	M12 socket, shielded, 2 m black, PUR cable	EVC544
	M12 socket, shielded, 5 m black, PUR cable	EVC545

Common technical data

Operating voltage	[V DC]	18...32
Current consumption	[mA]	≤ 50
Ambient temperature	[°C]	0...65
Protection		IP 65
Reverse polarity protection		•
Short-circuit protection		•
IO-Link revision		1.1

Measuring range / distance

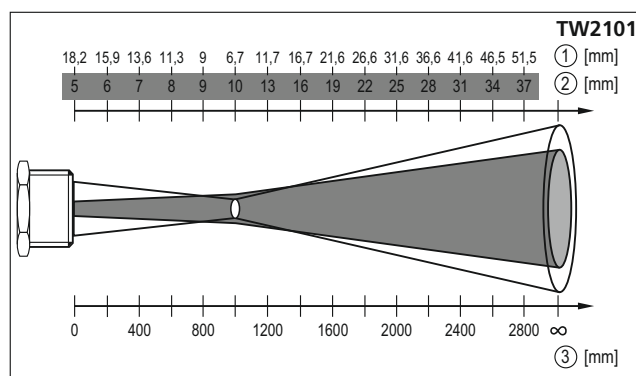
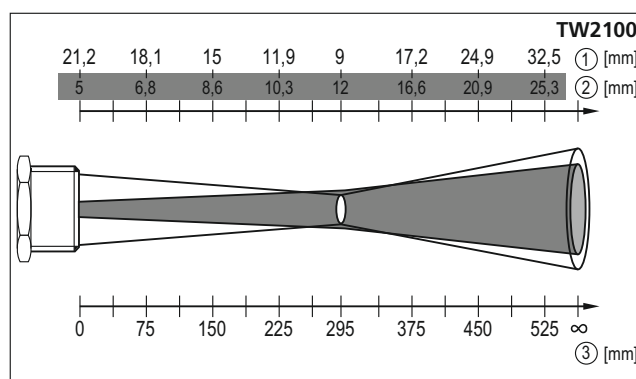

- 1) measuring segment diameter
- 2) diameter LED pilot light
- 3) measuring distance



Process sensors

Precise temperature sensors with internal drift monitoring



Temperature sensors



Integrated drift detection via PT and NTC element

Permanent drift monitoring increases process reliability between the calibrations

Calibration intervals can be adapted or be dispensed with

Free 5-point calibration certificate supplied with the sensor

High precision of ± 0.2 K in the range of $-10...130$ °C



EC 1935 / 2004



Increased process reliability via permanent drift monitoring

The sensors of the TAD series have two resistance elements with different characteristics (PT and NTC) that monitor each other permanently in the process. Occurring drift is immediately detected and signalled. This increases the process reliability. All three process values (mean value, PT element, NTC element) can be documented via IO-Link. This ensures permanent transparency for quality management. Calibration intervals can be adapted or be dispensed with.

Precise 5-point calibration from the factory

Due to a 5-point temperature adjustment during the production process, the TAD temperature sensor features an accuracy of ± 0.2 K in the range of $-10...130$ °C.





Electrical design	Process connection	Probe length [mm]	Response dynamics T05 / T09 [s]	Operating voltage [V DC]	Programming interface	Order no.
TAD transmitter 4...20 mA · 2-wire or 3-wire operation						
4...20 mA (scalable)	G 1/2 male	33	3 / 6	18...32	IO-Link 1.1	TAD991
4...20 mA (scalable)	G 1/2 male	50	3 / 6	18...32	IO-Link 1.1	TAD091
4...20 mA (scalable)	G 1/2 male	87.5	3 / 6	18...32	IO-Link 1.1	TAD191
4...20 mA (scalable)	Aseptoflex Vario	33	3 / 6	18...32	IO-Link 1.1	TAD981
4...20 mA (scalable)	Aseptoflex Vario	50	3 / 6	18...32	IO-Link 1.1	TAD081
4...20 mA (scalable)	Aseptoflex Vario	87.5	3 / 6	18...32	IO-Link 1.1	TAD181

Programming options: threshold for drift warning / alarm; fail-safe; scaling analogue output; redundancy switching; performance diagnostic output; output logic; NO/NC

Accessories

Type	Description	Order no.
Installation		
	Aseptoflex Vario welding adapter* Ø 50 mm	E30122
	Sealing by O-ring	
	Aseptoflex Vario adapter* Clamp 2", ISO 2852	E33702
	Metal-to-metal seal	
	Aseptoflex Vario adapter* Varivent type N, DN40 (1.5"), Ø 68 mm	E33722
	Metal-to-metal seal	
	Aseptoflex Vario adapter* pipe fitting, DN40 (1.5"), DIN 11851	E33712
	Metal-to-metal seal	
	Adapter G 1/2 female – Clamp 1"–1.5"	E33401
	Adapter G 1/2 female – Clamp 2"	E33402
	Welding adapter ball, G 1/2	E30055
	Welding adapter collar, G 1/2	E30056

IO-Link

	USB IO-Link master for parameter setting and analysis of units Supported communication protocols: IO-Link (4.8, 38.4 and 230 kBit/s)	E30390
	Memory plug, parameter memory for IO-Link sensors	E30398
	LR DEVICE (supplied on USB flash drive) Software for online and offline parameter setting of IO-Link sensors and actuators	QA0011

* further Aseptoflex Vario adapters available



Further technical data

Self-monitoring temperature sensor Liquids and gases		
Measuring range	[°C]	-25...150 / 160 max. 1h
Perm. overload pressure	[bar]	50
Accuracy / deviations		± 0.2 (-10...130 °C); ± 0.3 (130...140 °C); ± 0.3 ± 0.1% MS (-25...-10/140...160 °C)
Resolution	[°C]	< 0.05
Protection		IP 68 / IP 69K
Measuring element		Pt1000 / NTC, thermally coupled
Materials in contact with the medium		high-grade stainless steel (1.4404 / 316L)
Surface characteristics		Ra: < 0.6
Connection		M12 connector, gold-plated contacts

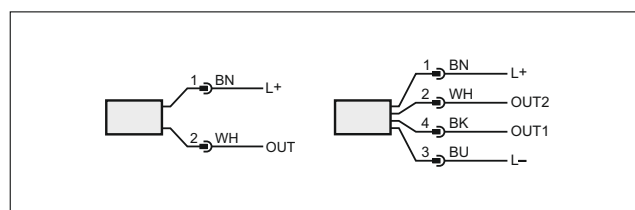
Wiring diagram

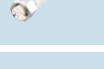

Connection technology

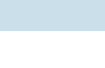
Type	Description	Order no.
	Socket, M12, 4-pole 5 m, grey, MPPE cable	EVF001
	Socket, M12, 4-pole 10 m, grey, MPPE cable	EVF002
	Socket, M12, 4-pole 5 m, grey, MPPE cable	EVF004
	Socket, M12, 4-pole 10 m, grey, MPPE cable	EVF005



Process sensors

Fast hygienic temperature transmitter up to 200 °C



Temperature sensors



Also suitable for small nominal pipe diameters and confined spaces

Very fast response time
< 0,25 / < 1 s

Free 3-point factory certificate available online

Different hygienic process connections and probe diameters selectable

Different installation lengths up to 350 mm



Analogue and IO-Link

The temperature transmitter has an analogue output with 4...20 mA. The parameters are set via the integrated IO-Link interface which can also be used as a communication interface.

Precise and quick

The TA temperature sensors achieve a high accuracy. The user can download the 3-point factory certificate for his sensor for free at www.factory-certificate.ifm. The innovation besides the maximum temperature range is the excellent response time.

Therefore the sensor is suitable for all highly-precise and fast processes in hygienic environments.

Transparent and flexible

An LED clearly signals the readiness for operation. Compact design, integrated process connections, different probe lengths and diameters (Ø 3 mm, Ø 6 mm) enable easy and flexible installation.



Type	Installation length [mm]	Factory setting [°C]	Order no.
Probe diameter 3 mm			
Process connection M12 x 1,5 with sealing cone			
	17	0...200	TA1102
	17	0...100	TA1107
	17	-10...150	TA1101
Process connection G 3/8 with coupling nut Ø 3 mm			
	83	0...200	TA1322
	83	0...100	TA1327
	83	-10...150	TA1321

Accessories

Type	Description	Order no.
	USB IO-Link master for parameter setting and analysis of units Supported communication protocols: IO-Link (4.8, 38.4 and 230 kBit/s)	E30390
	Memory plug, parameter memory for IO-Link sensors	E30398
	LR DEVICE (supplied on USB flash drive) Software for online and offline parameter setting of IO-Link sensors and actuators	QA0011

Connection technology

Type	Description	Order no.
	Socket, M12, 4-pole 5 m, grey, MPPE cable	EVF001
	Socket, M12, 4-pole 10 m, grey, MPPE cable	EVF002
	Socket, M12, 4-pole 5 m, grey, MPPE cable	EVF004
	Socket, M12, 4-pole 10 m, grey, MPPE cable	EVF005

Type	Installation length [mm]	Factory setting [°C]	Order no.
Probe diameter 6 mm			
Process connection Clamp 3/4"			
	25	0...200	TA2002
	60	0...200	TA2012
Process connection Clamp 1.5"			
	30	0...200	TA2802
	50	0...200	TA2812
	100	0...200	TA2832
	150	0...200	TA2842
Process connection G 1/2 with sealing cone			
	30	0...200	TA2502
	50	0...200	TA2512
	50	0...100	TA2517
	50	-10...150	TA2511
	100	0...200	TA2532
	100	0...100	TA2537
	100	-10...150	TA2531
	150	0...200	TA2542
Process connection Ø 6 mm			
	50	0...200	TA2212
	100	0...200	TA2232
	150	0...200	TA2242
	150	0...100	TA2247
	150	-10...150	TA2241
	250	0...200	TA2262
	350	0...200	TA2292

Further technical data

Operating voltage	[V DC]	18...32
Reverse polarity / overload protection		• / •
Output function	[mA]	4...20
Protection		IP 67, IP 68, IP 69K / III
Measuring range	[°C]	-50...200
Accuracy	[K]	± 0.3 + (± 0.1 % MS)
Ambient temperature	[°C]	-25...80
IO-Link revision		1.1
Materials in contact with the medium		high-grade stainless steel (1.4404 / 316L)



Process sensors

Sensors for the food industry with free factory certificate



Pressure sensors / temperature sensors



Factory certificate as documentary evidence of the accuracy

For selected pressure and temperature sensors in the food industry

**Download at:
www.factory-certificate.ifm**

Saves costs and simplifies ordering

Further detailed and individual calibration certificates can be ordered separately



EC 1935 / 2004



Simply download the calibration certificate

The accuracy of measuring devices in production processes is decisive for the quality of the end product. This is why ifm offers a free 3-point factory certificate for selected pressure and temperature sensors for the food industry. This certificate remains available for download for five years. Simply log in to „my ifm“ at www.factory-certificate.ifm, enter the serial number and download the certificate.

This procedure saves costs and time, as a separate order is no longer required. Thanks to the factory certificate no initial calibration at the customer's is required any more.

Further certificates

Further certificates, e.g. declarations of compliance or material inspection certificates to EN 10204 2as well as calibration certificates to ISO or DAkkS can still be ordered separately.



The free 3-point factory certificate is available for the following pressure and temperature sensors:

Temperature sensors of type: TD, TA20, TA22, TA25, TA28 and TA13

Pressure sensors of type: PI27, PI28 and PI2602

All certificates are issued in two languages (German/English).

Moreover, the following certificates are available:

Declaration of compliance EN10204-2.1 (order no. ZC0001) (according to DIN50049-2.1)

- Certifies that the listed articles / article groups conform to the indications in the corresponding data sheet and have been subjected to a final test.
- Attachment: data sheet

Test report EN10204-2.2 (order no. ZC0002) (according to DIN 50049-2.2)

- Certifies that the listed articles conform to the indications in the corresponding data sheet and have been subjected to a 100 % final test.
- Attachments: description of the 100 % tests, data sheet and, where applicable, test specification

The following documents are moreover available for selected fluid sensor products: All certificates are issued in two languages (German/English)

Inspection certificate material EN10204-3.1 (order no. ZC0003) (according to DIN 50049-3.1)

- Results of batch-related tests to prove that the requirements regarding the material characteristics and quality are met.
- Applies to the specified article(s) and must be requested when ordering the article.
- Only issued for selected fluid sensor products: www.ifm.com

ISO calibration pressure/flow (order no. ZC0004 (pressure/flow)), ZC0020 (flow SD)

- Issued by the manufacturer
- Applies to the specified article(s) and must be requested when ordering the sensor. Subsequent orders are only possible if the device is returned.
- Only issued for selected fluid sensor products: www.ifm.com

Created to the requirements of the DAkkS (German accreditation body)

Only issued for selected pressure sensors:
www.ifm.com

DAkkS calibration pressure sensors (order no. ZC0005)

- Applies to the specified article(s) and must be requested when ordering the sensor. Subsequent orders are only possible if the device is returned.

Created to the requirements of the DAkkS (German accreditation body)

Only issued for selected temperature sensors:
www.ifm.com

3-point DAkkS calibration temperature sensors (order no. ZC0013)

- Calibration at three defined temperatures: 65-85-123 °C
- Applies to the specified article(s) and must be requested when ordering the sensor. Subsequent orders are only possible if the device is returned.

5-point DAkkS calibration temperature sensors (order no. ZC0014)

- Calibration at five defined temperatures: 20-65-85-100-123 °C
- Applies to the specified article(s) and must be requested when ordering the sensor. Subsequent orders are only possible if the device is returned.

n-point DAkkS calibration temperature sensors (order no. ZC0015)

- Number (max. 4) and positions of the calibration points as requested by the customer (-20...150 °C)
- Applies to the specified article(s) and must be requested when ordering the sensor. Subsequent orders are only possible if the device is returned.

Created according to the requirements to DIN EN ISO 9001:2008

Only issued for selected temperature sensors:
www.ifm.com

3-point ISO calibration temperature sensors (order no. ZC0016)

- Calibration at three defined temperatures: 65-85-123 °C
- Applies to the specified article(s) and must be requested when ordering the sensor. Subsequent orders are only possible if the device is returned.

5-point ISO calibration temperature sensors (order no. ZC0017)

- Calibration at five defined temperatures: 20-65-85-100-123 °C
- Applies to the specified article(s) and must be requested when ordering the sensor. Subsequent orders are only possible if the device is returned.

n-point ISO calibration temperature sensors (order no. ZC0018)

- Number (max. 4) and positions of the calibration points as requested by the customer (-20...150 °C)
- Applies to the specified article(s) and must be requested when ordering the sensor. Subsequent orders are only possible if the device is returned.

You can find more certificates at: www.ifm.com



AS-i illuminated pushbutton module with M12 connector



AS-Interface I/O modules



2 pushbuttons and 2 LED outputs

Pushbuttons with tactile pressure point as protection against accidental contact

Colour inserts changeable

Quick and easy to mount

The module is directly supplied from AS-Interface



Illuminated pushbutton module

On the basis of a new innovative housing, ifm provides two new illuminated pushbutton modules. They feature two pushbuttons and 2 types of LED output. The high protection rating means the modules can be used in the field, i.e. close to the process.

There are no long distances between sensors/actuators and the control cabinet.

Performance in the field

The M12 connection technology provides a high degree of installation reliability and flexibility. Both modules are exclusively supplied via AS-i; an additional 24 V voltage source is not required. The modules are simply mounted on a 35 mm DIN rail or using the supplied mounting adapter.



Addressing

The AS-i modules are addressed via the front M12 plug. The modules can be connected to the addressing unit using the standard connection cable.

Diagnostic LED

The FAULT LED on the module ensures easy localisation of a fault, such as a communication error.

Dimensions

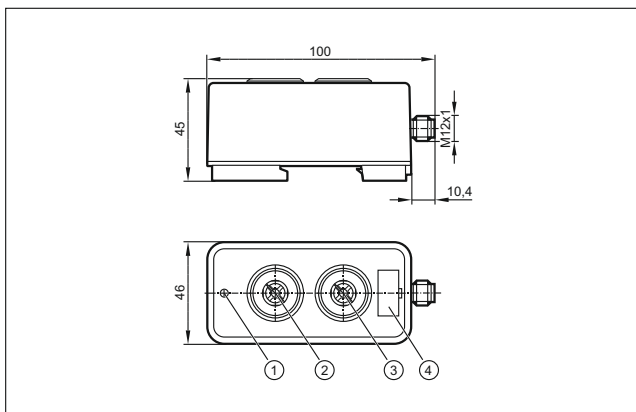



- 1) LED PWR / FAULT
- 2) button 1 / LED 1
- 3) button 2 / LED 2
- 4) panel for labelling

The products

Design	Description	Order no.
--------	-------------	-----------

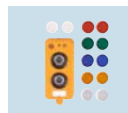
AS-i illuminated pushbutton module

	2 buttons / 2 LEDs, colour inserts changeable, 2 white LEDs, 2 NO	AC2386
---	--	---------------

	2 buttons / 2 LEDs, Colour inserts red / green, red / green LED, normally closed / normally open	AC2388
---	---	---------------

Common technical data

Operating voltage	[V DC]	26.5...31.6
Total current consumption	[mA]	< 55
Sensor supply Inputs / outputs	[V DC]	via AS-i
Extended addressing mode		•
AS-i specification		2.11 + 3.0
Ambient temperature	[°C]	-25...60
Protection		IP 67

Accessories

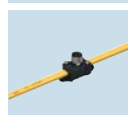

Design	Description	Order no.
--------	-------------	-----------

	FC insulation displacement connector, round cable 0.6 m to M12 socket	E70483
---	--	---------------

	FC insulation displacement connector, M12	AC5005
---	--	---------------

Connection technology

Design	Description	Order no.
--------	-------------	-----------

	Connection cable, M12, 1 m black, PUR cable	EVC042
	Connection cable, M12, 2 m black, PUR cable	EVC043



SafeLine SmartPLC: fail-safe automation system



AS-Interface Safety at Work



Quick and easy set-up

**Flexible and future-proof
thanks to connective hardware
and CODESYS V3**

**High machine uptime due
to sophisticated diagnostics**

Safe up to SIL 3, PL e

**Unbeatable
price / performance ratio**

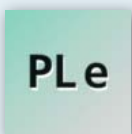

All-in-one: more than just a PLC

Just as a smartphone is more than just a phone, the new SmartPLC is more than just a simple PLC. It has the flexibility for different tasks, even in safety-related applications up to SIL 3, PL e.

For example as:

- fail-safe PLC
- standard PLC
- AS-i gateway
- visualisation system
- protocol converter
- data logger
- intelligent evaluation unit (ifm system solutions)

Two integrated PLCs (1 x fail-safe, 1 x standard), powerful processors, a large memory and a multitude of supported protocols allow the control of sophisticated systems – and this at an unbeatable price!



All-in-one

The new SmartPLC combines two separate PLCs in one compact housing. While the one PLC solves safety-related applications, the second PLC either works as a standard PLC or as platform for other tasks.

Both PLCs communicate with each other, so that entire plant controls can be implemented including safety functions and visualisations with only one SmartPLC.

Products

Type	Description	Order no.
SmartSPS SafeLine		
	SmartSPS SafeLine, 2 x AS-i, Profinet-Device	AC402S
	SmartSPS SafeLine, 2 x AS-i, Profibus-Slave	AC412S
	SmartSPS SafeLine, 2 x AS-i, EtherNet/IP-Device	AC422S
	SmartSPS SafeLine, 2 x AS-i, EtherCAT-Slave	AC432S

Dimensions

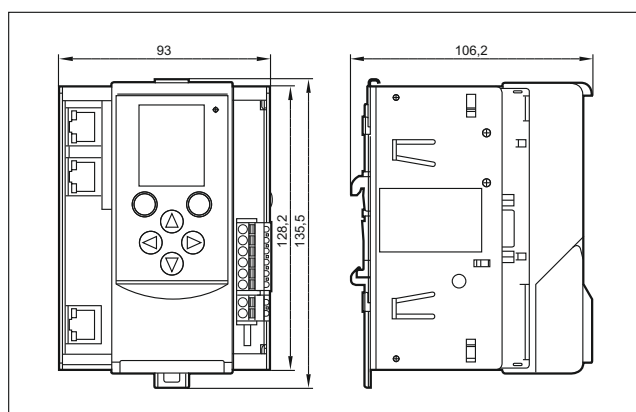

Accessories

Type	Description	Order no.
	AS-i data decoupling module	AC1250

Safe PLC

Certified up to SIL3, PL e. Eight safe local inputs and four safe local outputs. In addition to the AS-i and the local inputs and outputs I/O (standard and safe) can be expanded via EtherCAT + FSoE. Furthermore several SmartPLC SafeLine devices can be linked via the fail-safe cross communication.

Convenient diagnostic functions, include status indication for safe I/Os and error memory with time stamp for up to 2,000 messages.

Programming is done via CODESYS V3. The auto-teach function simplifies the replacement of slaves.

Standard PLC

The PLC can be freely programmed using CODESYS V3. Its software and hardware operates independently of the fail-safe PLC, but it can of course communicate with it and exchange data. The PLC has access to all interfaces of the system.

AS-i gateway

Without programming, the SmartPLC can be used directly as a gateway for AS-i on the one side, and Profinet, Profibus, EtherNet/IP or EtherCAT on the other side. The integrated display and the convenient web interface display all the available status information for the user and support diagnostics in case of a fault.

Data logger

Operational system data can be recorded via AS-i, Modbus TCP, Profinet, EtherNet/IP, EtherCAT, TCP/IP, UDP/IP and stored on the SD card or in the internal flash memory.

If needed, the integrated real-time clock provides a time stamp for each recorded data block. This simplifies the documentation and diagnostics of processes.

Visualisation system

A freely programmable web visualisation based on HTML5 provides maximum transparency. An internet browser with HTML5 capability is sufficient on the final unit (PC, tablet, smartphone). No further software is required. Even the full graphic display of the SmartPLC is freely programmable for visualisation tasks.

Protocol converter

Connect your sensors and Ethernet based devices to your fieldbus: The SmartPLC can be used as protocol converter between Profinet, Profibus, EtherNet/IP, EtherCAT on the one side and AS-i, EtherNet/IP, EtherCAT, Modbus TCP, TCP/IP, UDP/IP on the other side.



Worldwide innovation: AS-i signal transmission via fibre optic



AS-Interface wiring technology



AS-Interface signal transmission over a distance of up to 3.2 km

Possibility of mixed operation (AS-i flat cable and fibre optic)

Lightning protection, radiated EM interference immunity

High operational reliability

Electrical separation

Plug-in connection terminals



IP 20



LED diagnostics

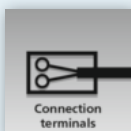

AS-i fibre optic repeater

ifm's new AS-i fibre optic repeater enables AS-Interface signal transmission via an optical medium and vice versa. This allows for considerable cable length extension in the AS-i network.

Every AS-i fibre optic repeater has two independent channels that consist of a transmitting and a receiving element which are supplied via the AS-Interface system. Various LEDs indicate the current operating status. This innovation is integrated into the new SmartLine housing.



Performance in the field

Optical transmission means there is no interfering radiation, nor are there any ground problems. Fibre optic transmission systems exclude any EMC risk, as a matter of principle.

As to distance related losses due to inductances, capacities and resistances (as is the case with copper cables for example), they do not occur either. Consequently, the new AS-i fibre optic repeater contributes decisively to life time extension and cost reduction.

Using the new AS-i fibre optic repeater allows for additional fibre optic network topologies (line topology, star topology).

Dimensions

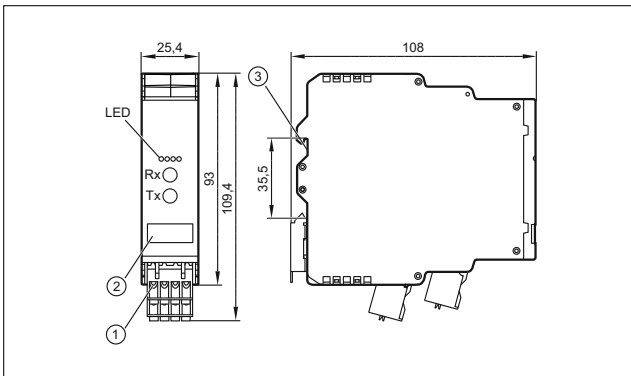

- 1) plug with cage clamp connection
- 2) panel for labelling
- 3) Din rail adapter

Products

Type	Description	Order no.
------	-------------	-----------

Smartline AS-i fibre optic repeater



Cable length in the AS-i network of up to 3.2 km, integrated passive bus termination, protection rating IP20, COMBICON connectors

AC3227

Technical data

Smartline AS-i fibre optic repeater AC3227

Operating voltage	[V DC]	26.5...31.6
Total current consumption	[mA]	< 80
AS-i specification		2.11 + 3.0
Fibre optic connector		ST
Compatible fibre types		Multimode: 50/125 µm, 62.5/125 µm
Ambient temperature	[°C]	-25...70
Protection		IP 20

Accessories

Type	Description	Order no.
------	-------------	-----------



AS-i power supply 115/230 V AC, output current (AS-i) 4 A

AC1257



AS-i power supply 115/230 V AC, output current (AS-i) 8 A

AC1258



Fibre optic cable, ST / ST, IP 20, 50 µm, 20 m, PUR

E74800

Fibre optic cable, ST / ST, IP 20, 50 µm, 50 m, PUR

E74801

Fibre optic cable, ST / ST, IP 20, 50 µm, 100 m, PUR

E74802



IO-Link



IO-Link master for intelligent sensors in the control cabinet



IO-Link masters CabinetLine



Separation between automation and IT network

Industry 4.0 ready via new IoT core

8 IO-Link ports with full V1.1 functionality

PROFINET, EtherNet/IP, EtherCat, Modbus TCP or TCP/IP JSON

Master and device configurable via the LR DEVICE software

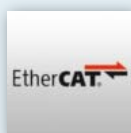

IO-Link master for the automation and IT world

The IO-Link master modules for the control cabinet serve as a gateway between intelligent IO-Link sensors and the field bus. Besides, important information of the intelligent sensors can simultaneously be sent into the IT world.

With a separate IoT Ethernet socket the IT network can be set up completely separated from the automation network. Sensor information is transferred into the IT world via the established TCP/IP JSON interface.



Advantages and customer benefits

• Separation between automation and IT network

Machine uptime is of highest priority. The automation network must by no means be interrupted by external factors. Therefore the unit features a separate IoT Ethernet socket separating IT and automation network. This means that important sensor information can be safely sent to the IT and ERP systems.

• Sensor configuration with LR DEVICE

The intuitive software finds all IO-Link masters in the network and creates an overview of the whole plant. In addition, all connected sensors are displayed with the respective parameters. This makes it possible to set the parameters of all sensors in the system from one central point.

• Easy sensor connection

The sensors and actuators are connected via standard M12 connection cables without screening. The connection cables are fixed via removable COMBICON connectors on the IO-Link master. Up to 8 IO-Link sensors can be connected and be supplied with up to 3.6 A. The cable can be up to 20 m long.

• Reliable digital data

The sensor data is transferred digitally. Unlike analogue signals, contact resistance and EMC interference cannot corrupt the signals.

Dimensions

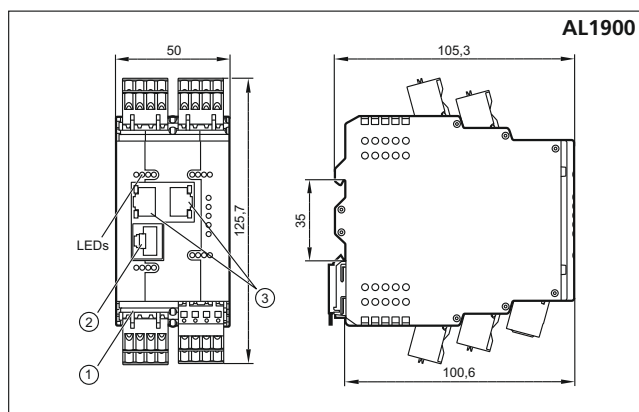

- 1) Combicon connector
- 2) IoT-Port
- 3) Profinet IO data interface



The products

Type	Description	Order no.
IO-Link master CabinetLine		
	PROFINET 8-port	AL1900
	EtherNet/IP 8-port	AL1920
	EtherCat 8-port	AL1930
	Modbus TCP 8-port	AL1940

Technical data

IO-Link master CabinetLine AL1900, AL1920, AL1930, AL1940		
Operating voltage	[V DC]	20...30
Total current consumption	[A]	≤ 3.9
IO-Link version		1.1
Number of IO-Link ports		8 A ports
Number of binary inputs		8 + 8
Number of binary outputs		8
Parameter memory		•
Current for all ports (device supply)	[A]	≤ 3.6
Protection		IP 20
Electrical connections		COMBICON connector
Installation		DIN rail
Ambient temperature	[°C]	-25...65
Dimensions	[mm]	114.2 x 50 x 105.3

Accessories

Type	Description	Order no.
	LR DEVICE (supplied on USB flash drive) Software for online and offline parameter setting of IO-Link sensors and actuators	QA0011
	Ethernet adapter M12 / RJ45	E21140

Connection technology

Type	Description	Order no.
M12 socket		
	1 m black, PUR cable	EVC471
	2 m black, PUR cable	EVC001
	5 m black, PUR cable	EVC002
	10 m black, PUR cable	EVC003
	20 m black, PUR cable	EVC083



IO-Link



IO-Link master: Connection of sensors to the PLC and to the IT world



IO-Link master
DataLine Coolant / Food



Industry 4.0 ready via new IoT core

Separation between automation and IT network

4 or 8 IO-Link ports with full V1.1 functionality

PROFINET, EtherNet/IP, EtherCat, Modbus TCP or TCP/IP JSON

Master and device configurable via the LR DEVICE software



IO-Link master for the automation and IT world

The decentralised IO-Link master modules serve as a gateway between intelligent IO-Link sensors and the field bus. Besides, important information of the intelligent sensors can simultaneously be sent into the IT world. With a separate IoT Ethernet socket the IT network can be set up completely separated from the automation network. Sensor information is transferred into the IT world via the established TCP/IP JSON interface.

Robust field bus modules for demanding applications

Thanks to their special housing materials and high ingress resistance (IP 67 or IP 69K), they can be used in coolant applications or directly in wet areas in the food industry. The ecolink technology guarantees reliable, permanently ingress-resistant M12 connections of the connection cables.



Advantages and customer benefits

• Separation between automation and IT network

Machine uptime is of highest priority. The automation network must by no means be interrupted by external factors. Therefore the unit features a separate IoT Ethernet socket separating IT and automation network. This means that important sensor information can be safely sent to the IT and ERP system.

• Sensor configuration with LR DEVICE

The intuitive software finds all IO-Link masters in the network and creates an overview of the whole plant. In addition, all connected sensors are displayed with the respective parameters. This makes it possible to set the parameters of all sensors in the system from one central point.

• Easy sensor connection

The sensors and actuators are connected via standard M12 connection cables without screening. Depending on the device type, up to 4 or 8 IO-Link sensors can be connected and supplied with up to 3.6 A. With the EVC693 or EVF693 accessories, additional auxiliary power for the connection of IO-Link actuators can be supplied. The cable can be up to 20 m long.

Connection technology

Type	Description	Order no.	
		Coolant	Food
Ethernet cable (fieldbus)			
	0.5 m	E12490	EVF530
	2 m	E12090	EVF531
	5 m	E12491	EVF532
	10 m	E12492	EVF533
M12 socket 1 mm² (power)			
	2 m	EVC706	EVF480
	5 m	EVC707	EVF481
	10 m	EVC708	EVF482
	20 m	EVC709	EVF483
M12 jumper cable 0.34 mm² (sensor)			
	1 m	EVC042	EVF042
	2 m	EVC043	EVF043
	5 m	EVC044	EVF044
	10 m	EVC493	EVF045
Y splitter (adapter A port / B port)			
	1 m	EVC693	EVF693
	2 m	EVC694	EVF694
	5 m	EVC695	EVF695
	10 m	EVC696	EVF696

The products

Type	Description	Order no.	
		Coolant	Food
IO-Link master DataLine			
	Profinet 4-port	AL1300	AL1301
	EtherNet/IP 4-port	AL1320	AL1321
	EtherCat 4-port	AL1330	AL1331
	Modbus TCP 4-port	AL1340	AL1341
	Profinet 8-port	AL1302	AL1303
	EtherNet/IP 8-port	AL1322	AL1323
	EtherCat 8-port	AL1332	AL1333
	Modbus TCP 8-port	AL1342	AL1343

Technical data

IO-Link master DataLine Coolant / Food	Order no.			
	AL1300 AL1320 AL1330 AL1340	AL1302 AL1322 AL1332 AL1342	AL1301 AL1321 AL1331 AL1341	AL1303 AL1323 AL1333 AL1343
Operating voltage	20...30 V DC			
Total current consumption	≤ 3.9 A			
IO-Link version	1.1			
Number of IO-Link ports	4 A ports	8 A ports	4 A ports	8 A ports
Number of binary inputs	4 + 4	8 + 8	4 + 4	8 + 8
Number of binary outputs	4	8	4	8
Parameter memory	•			
Current for all A ports	≤ 3.6 A (device supply)			
Protection	IP 65, IP 67		IP 65, IP 67, IP 69K	
Ambient temperature	-25...60 °C			
Housing materials / socket	Polyamide / brass nickel-plated		Polyamide / stainless steel	

Accessories

Type	Description	Order no.
	LR DEVICE (supplied on USB flash drive) Software for online and offline parameter setting of IO-Link sensors and actuators	QA0011
	Coolant, protective caps M12 (10 pcs)	E73004
	Food, protective caps M12 4 pcs, high-grade stainless steel	E12542

ifm – close to you!

For further technical details please visit: www.ifm.com
(11.2017)



IO-Link



IO-Link master: connection for intelligent sensors



IO-Link masters
StandardLine Coolant



4 or 8 IO-Link ports with full V1.1 functionality

Profinet or EtherNet/IP

Master and devices configurable via the LR DEVICE software

Industry 4.0 ready via LR AGENT EMBEDDED

Voltage supply via standard M12 sensor cable, A-coded



Robust field bus modules with safe connection

The decentralised IO-Link master modules are used as gateways between intelligent IO-Link sensors and the fieldbus. They are the perfect choice, even in the most difficult environments: The materials and production methods are identical to the ifm jumper cables of the tried-and-tested EVC product series. The ecolink technology guarantees reliable, permanently ingress-resistant M12 connections of the connection cables.

Energy limitation for UL class 2 units

Many sensors require an energy-limited supply with UL class 2 approval. The limitation of energy is usually achieved via a corresponding power supply. With the AL series IO-Link master, sensors can be supplied according to UL class 2 without using an energy-limited power supply approved to UL class 2.



Advantages and customer benefits

• Sensor configuration with LR DEVICE

The intuitive software finds all IO-Link masters in the network and creates an overview of the whole plant. Besides, all sensors connected are indicated with the respective parameters. This means that parameter setting of all sensors in the system is possible from one central point.

• Easy sensor connection

The sensors and actuators are connected via standard M12 connection cables without screening. Depending on the device type, up to 4 or 8 IO-Link sensors can be connected and supplied with up to 3.6 A. With the EVC693 accessories, additional auxiliary power for the connection of IO-Link actuators can be supplied. The cable can be up to 20 m long.

• Reliable digital data



The sensor data is transferred digitally. Unlike analogue signals, contact resistance and EMC interference cannot corrupt the signals.

• Direct connection to the IT



The integrated LR AGENT EMBEDDED is capable of transmitting the process values directly to ERP systems, without detour via the PLC.

This second communication path is available in parallel to the fieldbus via the bus wiring.

Connection technology

Type	Description	Order no.
Ethernet cable (fieldbus)		
	0.5 m	E12490
	2 m	E12090
	5 m	E12491
	10 m	E12492
M12 socket 1 mm² (power)		
	2 m	EVC706
	5 m	EVC707
	10 m	EVC708
	20 m	EVC709
M12 connection cable 0.34 mm² (sensor)		
	1 m	EVC042
	2 m	EVC043
	5 m	EVC044
	10 m	EVC493

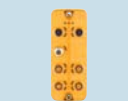

Products

Type	Description	Order no.
IO-Link master StandardLine Coolant		
	Profinet 4-port	AL1100
	EtherNet/IP 4-port	AL1120
	Profinet 8-port	AL1102
	EtherNet/IP 8-port	AL1122
IO-Link module Coolant		
	Input module 4 x 2DI	AL2400
	input module 8 x 2DI	AL2401
	Output module 6 x 2DO	AL2330

Technical data

IO-Link master StandardLine Coolant	Order no.	
	AL1100 AL1120	AL1102 AL1122
Operating voltage	[V DC]	20...30
Total current consumption	[A]	≤ 3.9
IO-Link version		1.1
Number of IO-Link ports	4 A ports	8 A ports
Number of binary inputs (IO-Link in SIO mode)	4 + 4	8 + 8
Number of binary inputs (IO-Link in SIO mode)	4	8
Parameter memory		•
Current for all ports (device supply)	[A]	≤ 3.6
Protection		IP 65, IP 67
Ambient temperature	[°C]	-25...60
Housing materials		polyamide; socket: nickel-plated brass

Accessories

Type	Description	Order no.
	LR DEVICE (supplied on USB flash drive) Software for online and offline parameter setting of IO-Link sensors and actuators	QA0011
	Y splitter, for connection of two sensors to a port, M12 connector / 2x M12 socket	EBC113
	Protective caps M12 (10 pcs)	E73004



IO-Link



IO-Link master for intelligent sensors in hygienic areas



IO-Link masters
StandardLine Food



4 or 8 IO-Link ports with full V1.1 functionality

IP 69K field module for the food industry

Master and devices configurable via the LR DEVICE software

Industry 4.0 ready via LR AGENT EMBEDDED

Voltage supply via standard M12 sensor cable, A-coded



Robust field bus modules for demanding applications

The decentralised IO-Link masters are used as gateways between intelligent IO-Link sensors and the fieldbus. Thanks to their special housing materials and high ingress resistance (IP 69K), they can be used directly in wet areas in the food industry. The materials and production methods are identical to the ifm jumper cables of the tried-and-tested EVF product series.

The ecolink technology guarantees reliable, permanently ingress-resistant M12 connections of the connection cables.

High-quality materials especially suited to the application and intensive monitoring during and after production guarantee maximum quality standards.



Advantages and customer benefits

- **Configuration of sensors with LR DEVICE**

The intuitive software finds all IO-Link masters in the network and creates an overview of the whole plant. Besides, all sensors connected are indicated with the respective parameters. This means that parameter setting of all sensors in the system is possible from one central point.

- **Use as masters for the food industry**

These masters can now also be used in hygienic applications due to the materials used and their innovative housing design.

- **Easy sensor connection**

The sensors and actuators are connected via standard M12 connection cables without screening. Depending on the device type, up to 4 or 8 IO-Link sensors can be connected and supplied with up to 3.6 A. The cable can be up to 20 m long.



- **Reliable digital data**

The sensor data is transferred digitally. Unlike analogue signals, contact resistance and EMC interference cannot corrupt the signals.



- **Direct connection to the IT**

The integrated LR AGENT EMBEDDED is capable of transmitting the process values directly to ERP systems, without detour via the PLC. This second communication path is available in parallel to the fieldbus via the bus wiring.

Connection technology

Type	Description	Order no.
Ethernet cable (fieldbus)		
	1 m	EVF530
	2 m	EVF531
	5 m	EVF532
	10 m	EVF533
M12 socket 1 mm² (power)		
	2 m	EVF480
	5 m	EVF481
	10 m	EVF482
	20 m	EVF483
M12 connection cable 0.34 mm² (sensor)		
	1 m	EVF042
	2 m	EVF043
	5 m	EVF044
	10 m	EVF045



Products

Type	Description	Order no.
IO-Link master StandardLine Food		
	Profinet 4-port	AL1101
	EtherNet/IP 4-port	AL1121
	Profinet 8-port	AL1103
	EtherNet/IP 8-port	AL1123
IO-Link-Module Food		
	Output module 6 x 2DO	AL2230

Technical data

IO-Link master StandardLine Food	Order no.	
	AL1101 AL1121	AL1103 AL1123
Operating voltage	[V DC]	20...30
Total current consumption	[A]	≤ 3.9
IO-Link version		1.1
Number of IO-Link ports	4 A ports	8 A ports
Number of binary inputs (IO-Link in SIO mode)	4 + 4	8 + 8
Number of binary inputs (IO-Link in SIO mode)	4	8
Parameter memory		•
Current for all ports (device supply)	[A]	≤ 3.6
Protection		IP 65, IP 67, IP 69K
Ambient temperature	[°C]	-25...60
Housing materials		polyamide; socket: stainless steel

Accessories

Type	Description	Order no.
	LR DEVICE (supplied on USB flash drive) Software for online and offline parameter setting of IO-Link sensors and actuators	QA0011
	Y splitter, for connection of two sensors to a port, M12 connector / 2x M12 socket	EBF006
	Protective caps M12 4 pcs., stainl. st.	E12542



IO-Link



IO-Link master with extra power

IO-Link masters
PowerLine Coolant



4 or 8 IO-Link ports with full V1.1 functionality

Feed-through of the power supply possible

Master and devices configurable via the LR DEVICE software

Industry 4.0 ready via LR AGENT EMBEDDED

Voltage supply via power cable, M12, T-coded



Robust field bus modules with safe connection

The decentralised IO-Link masters are used as gateways between intelligent IO-Link sensors and the fieldbus. They are the perfect choice, even in the most difficult environments: The materials and production methods are identical to the ifm jumper cables of the tried-and-tested EVC product series. The ecolink technology guarantees reliable, permanently ingress-resistant M12 connections of the connection cables.

Extra power

The IO-Link masters are equipped with two T-coded M12 connections for voltage supply. With this power cabling, the current path can simply be daisy-chained.

The B ports of the 8-port IO-Link master allow direct connection of IO-Link actuators, such as valve islands.



Advantages and customer benefits

• Sensor configuration with LR DEVICE

The intuitive software finds all IO-Link masters in the network and creates an overview of the whole plant. Besides, all sensors connected are indicated with the respective parameters. This means that parameter setting of all sensors in the system is possible from one central point.

• Easy sensor connection

The sensors and actuators are connected via standard M12 connection cables without screening. Depending on the device type, up to 4 or 8 IO-Link sensors can be connected and supplied with up to 3.6 A. With the EVC693 accessories, additional auxiliary power for the connection of IO-Link actuators can be supplied. The cable can be up to 20 m long.





• Direct connection to the IT

The integrated LR AGENT EMBEDDED is capable of transmitting the process values directly to ERP systems, without detour via the PLC. This second communication path is available in parallel to the fieldbus via the bus wiring.



• 12 amperes on an M12 connector

The master supply and the auxiliary power for the actuators are supplied via T-coded M12 connectors. The energy can be looped through the master (daisy chain).

Connection technology

Type	Description	Order no.
Ethernet cable (fieldbus)		
	0.5 m	E12490
	2 m	E12090
	5 m	E12491
	10 m	E12492
M12 socket 1.5 mm² (power)		
	0.5 m	E12494
	2 m	E12430
	5 m	E12495
	10 m	E12496
M12 connection cable 0.34 mm² (sensor)		
	1 m	EVC042
	2 m	EVC043
	5 m	EVC044
	10 m	EVC493
Y splitter		
	Y splitter, for connection of two sensors to a port, M12 connector / 2x M12 socket	EBC113



Products

Type	Description	Order no.
IO-Link master PowerLine coolant		
	Profinet 4-port	AL1200
	Profinet 8-port	AL1202
	EtherNet/IP 4-port	AL1220
	EtherNet/IP 8-port	AL1222
IO-Link module Coolant		
	Input module 4 x 2DI	AL2400
	Input module 8 x 2DI	AL2401
	Output module 6 x 2DO	AL2330

Technical data

IO-Link master PowerLine Coolant	Order no.	
	AL1200 AL1220	AL1202 AL1222
Operating voltage [V DC]	20...30	
Total current consumption US / UA [A]	≤ 3.9 / ≤ 3.6	
IO-Link version	1.1	
Number of IO-Link ports	4 A ports	4 A ports and 4 B ports
Number of binary inputs (IO-Link in SIO mode)	4 + 4	4 + 8
Number of binary inputs (IO-Link in SIO mode)	4	8
Parameter memory	•	
Current for all A ports (device supply) [A]	≤ 3.6	
Current for all B ports (actuator supply) [A]	≤ 3.6	
Protection	IP 65, IP 67	
Ambient temperature [°C]	-25...60	
Housing materials	polyamide; socket: nickel-plated brass	

Accessories

Type	Description	Order no.
	LR DEVICE (supplied on USB flash drive) Software for online and offline parameter setting of IO-Link sensors and actuators	QA0011
	Protective caps M12 (10 pcs)	E73004



IO-Link

Starter kit IO-Link master



IO-Link masters
StandardLine Coolant



**4-port IO-Link master with
PROFINET interface**

230V/24V plug-in power supply

**LR DEVICE (USB stick) IO-Link
parameter setting software**

**Photoelectric IO-Link distance
sensor**

Ethernet cable M12/RJ45, 0.5 m

Sensor cable M12/M12, 0.6 m



Starter kit IO-Link master

With this starter kit you can basically give the advantages of our IO-Link sensors a try directly on your desk. Transform a binary photoelectric distance sensor that only delivers a switch point 1 or 0 on a digital input card into an intelligent sensor and even measure the distance to the object. Besides the IO-Link master and the IO-Link sensor can be configured by means of the intuitive IO-Link parameter setting software. Complicated parameter setting on the display of the sensor is no longer necessary.

The decentralized IO-Link master serves as a gateway between intelligent IO-Link sensors and the fieldbus PROFINET. This means that it is also possible to set up a simple PROFINET connection e.g. to a Siemens controller.

To do this please download the "startup package" for the AL1100 from our website: www.ifm.com



Advantages and customer benefits

• Sensor configuration with LR DEVICE

The intuitive software finds all IO-Link masters in the network and creates an overview of the whole plant. In addition, all connected sensors are displayed with the respective parameters. This makes it possible to set the parameters of all sensors in the system from one central point.

• Easy sensor connection

The sensors and actuators are connected via standard M12 connection cables without screening. Depending on the device type, up to 4 or 8 IO-Link sensors can be connected and supplied with up to 3.6 A. With the EVC693 accessories, additional auxiliary power for the connection of IO-Link actuators can be supplied. The cable can be up to 20 m long.

• Reliable digital data

The sensor data is transferred digitally. Unlike analogue signals, contact resistance and EMC interference cannot corrupt the signals.

• Direct connection to the IT

The integrated LR AGENT EMBEDDED is capable of transmitting the process values directly to ERP systems, without detour via the PLC.

This second communication path is available in parallel to the fieldbus via the bus wiring.

The products

Type	Description	Order no.
Starter kit (complete set)		
	Starter kit IO-Link master	ZZ1100
Starter kit (individual components)		
	4-port IO-Link master with PROFINET interface	AL1100
	Plug-in power supply, 230 V/24 V	E30080
	LR DEVICE (USB stick), IO-Link parameter setting software	QA0011
	Photoelectric IO-Link distance sensor	O5D150
	Ethernet cable M12 / RJ45 0.5 m	E12490
	Sensor cable M12 / M12, 0.6 m	EVC041
IO-Link master StandardLine Coolant		
	Profinet 4-port	AL1100
	EtherNet/IP 4-port	AL1120
	Profinet 8-port	AL1102
	EtherNet/IP 8-port	AL1122

Further technical data

IO-Link Master StandardLine Coolant	Order no.	
	AL1100 AL1120	AL1102 AL1122
Operating voltage	[V DC]	20...30
Total current consumption	[A]	≤ 3.9
IO-Link version		1.1
Number of IO-Link ports	4 A ports	8 A ports
Number of binary inputs (IO-Link in SIO mode)	4 + 4	8 + 8
Number of binary inputs (IO-Link in SIO mode)	4	8
Parameter memory		•
Current for all ports (device supply)	[A]	≤ 3.6
Protection		IP 65, IP 67
Ambient temperature	[°C]	-25...60
Housing materials		Polyamide; socket: nickel-plated brass



IO-Link

M8 input module converts digital signals to IO-Link signals



IO-Link modules



To expand IO-Link master modules by digital inputs

Compact due to M8 sockets

Robust plastic housing in a small design for limited space

Short-circuit and overload detection



Digital inputs for IO-Link

The new IO-Link input modules provide an easy and cost-effective way to expand the IO-Link master modules for field use by digital inputs. The compact M8 version is used when digital signals have to be collected in a very small space.

Up to eight overload and short-circuit protected M8 ports are available. They collect 8 digital sensor signals in a decentralised manner and convert them to IO-Link communication. The connection to the master is established via an M12 connection cable. Fault analysis is available via IO-Link.

Robust



The robust plastic housing resists the harsh requirements in the field.

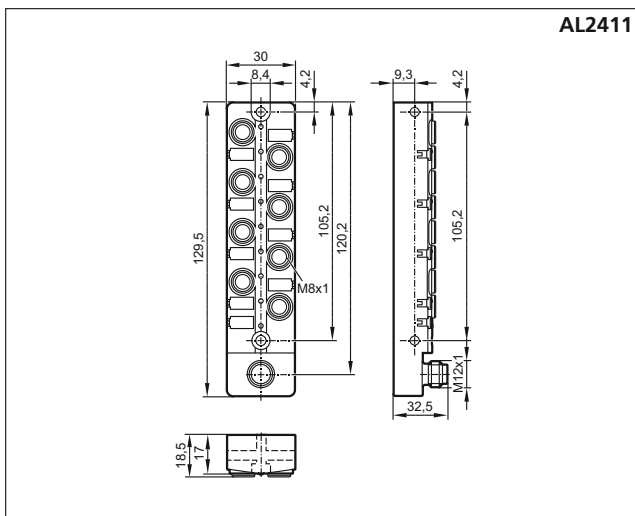
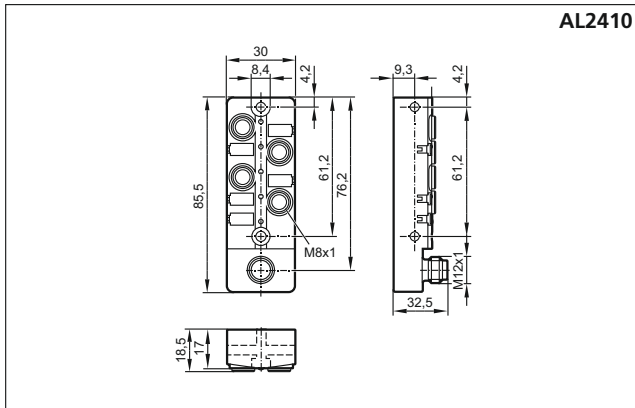

Dimensions





The products



Type	Description	Order no.
Active IO-Link input module, Coolant		
	4 x 1 inputs; IO-Link device V1.1; socket M8 x 1; O-ring; IP67	AL2410
	8 x 1 inputs; IO-Link device V1.1; socket M8 x 1; O-ring; IP67	AL2411

Further technical data	Order no.	
	AL2410	AL2411
Operating voltage [V DC]	18...30	
Max. current consumption via IO-Link [mA]	550	1050
Total current rating for all inputs [mA]	400	800
Ambient temperature [°C]	-25...70	
Housing materials	PBT; socket: nickel-plated brass; O-ring (socket): Viton	

Accessories

Type	Description	Order no.
	IO-Link master with Profinet interface	AL1100
	USB IO-Link master for parameter setting and analysis of units Supported communication protocols: IO-Link (4.8, 38.4 and 230 kBit/s)	E30390
	LR DEVICE (supplied on USB flash drive) Software for online and offline parameter setting of IO-Link sensors and actuators	QA0011

Connection technology

Type	Description	Order no.
	Connection cable M12 / M12, 0.5 m PUR cable, 4 wires, 1 mm ² , suitable for drag chains, halogen-free, silicone-free	EVC717
	Connection cable M12 / M12, 2 m PUR cable, 4 wires, 1 mm ² , suitable for drag chains, halogen-free, silicone-free	EVC719



IO-Link

IO-Link modules collect and convert digital signals



IO-Link devices



Effective connection of binary sensors to IO-Link

Adds 20 digital inputs to an IO-Link master

For use in industrial applications plus new variant for hygienic areas

**High protection rating
IP 68 / 69K**

Pre-processing of the input signals by digital input filters



Decentralised collection of digital signals via IO-Link

The new IO-Link input modules for field applications allow easy and economical adding of 20 digital inputs to IO-Link masters.

The activation of digital input filters such as debouncing, stretching or inverting allows easy optimisation of the input signals.

Applications

The module is available in two designs: The orange field module from the coolant series is resistant to oils and coolants and suited for general industrial applications.

The grey module is ideally suited for hygienic and food applications due to the material used for the housing. It has the high protection rating IP 68 / IP 69K.



Field modules with IO-Link connection

Up to 20 conventional sensors can be connected to these modules. IO-Link transfers the signals to any IO-Link master / PLC via one unscreened M12 cable.

A special feature of the modules is the pre-processing of the input signals via different filters before passing them on to IO-Link.

The following filters are available:

- debouncing (suppress noise signals)
- stretching (longer signals)
- inverting

This allows reliable detection of signals with a minimum length of 1.5 ms.

The decentralised positioning of the module reduces wiring costs and makes complex cabling obsolete. As opposed to bus systems IO-Link does not require any configuration or addressing. This simplifies installation.

Pins 2 and 4 of each M12 socket are configured as binary inputs. That means that dual sensors, normally closed or normally open, can be connected without any problem. The inputs have full overload and short-circuit protection.

Dimensions

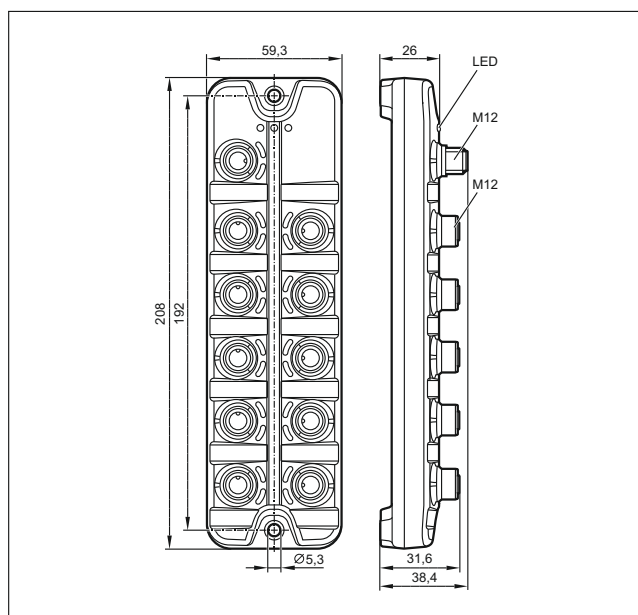

The products

Design	Description	Order no.
Active IO-Link input module, 10 x 2 inputs		
	IO-Link device V1.1; M12 connector; O-ring; stainless steel thread; IP 68, IP 69K; Food	AL2241
	IO-Link device V1.1; M12 connector; O-ring; stainless steel thread; IP 67; Coolant	AL2341*

* available from August 2018

Accessories

Design	Description	Order no.
	IO-Link master with PROFINET interface	AL1100
	USB IO-Link master for parameter setting and analysis of units Supported communication protocols: IO-Link (4.8, 38.4 and 230 Kbits/s)	E30390
	LR DEVICE (supplied on USB flash drive) Software for online and offline parameter setting of IO-Link sensors and actuators	QA0011
	Digital output module Food, IO-Link device V1.1, M12 connector, O-ring, thread: stainless steel, IP 68 / IP 69K	AL2230
	Digital output module Coolant, IO-Link device V1.1, M12 connector, O-ring, thread: nickel-plated brass, IP 67	AL2330



RFID antenna with a 200 mm range and diagnostic LED



RFID 13.56 MHz



Diagnostic and display LEDs for easy set-up

Communication to the PLC via DTE10x evaluation unit

Connection with rotatable M12 connector for standard cables of up to 20 m

Adjustable transmitting power

Extensive range of mounting accessories

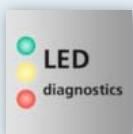
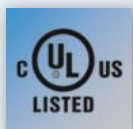

A multitude of applications with long ranges

The ANT600 antenna is ideal for long writing / reading distances.

A typical application is product tracking in the production process. The ANT600 may be used for storing e.g. production data or quality parameters on the ID tags.

In material logistics, the RFID system can easily determine whether the material and quantity of material match the production order.

In plant control, product-specific machine parameters can be read from the ID tag attached to the product.

The transmitting power can be adjusted in order to define different ranges.



Advantages of ifm's RFID solutions:

Connection to the RFID evaluation units of the DTE10x series.

The RFID antennas are designed for connection to the compact ifm evaluation unit DTE10x. This unit offers four M12 sockets for connection of up to four RFID antennas. Optionally, unused RFID inputs can also be used for the control of outputs or the detection of digital input signals.

Two digital sensors can be connected to each socket set as an input; and an actuator to each output.

For communication to the higher-level controller, the DTE10x has an EtherCAT, Profibus, Ethernet TCP/IP, EtherNet/IP or PROFINET interface, depending on the design.

The robust design with protection rating IP 67 permits use in harsh industrial environments.

Application example: RFID for detection of material during manufacture and of inflow and outflow in high-bay storage facilities

The ifm RFID solution with connection to a Siemens PLC is used as a system. The ifm components DTE 100, ANT600 and the RFID tag E80383 are used. The task consists of identifying an article marked with a 14-digit variable code and an order number.









Benefit for the customer: the indication and booking of the material inflow / outflow in real time closes the gap between the material stock in the warehouse and the stock indicated in the customer's software system. The system knows at all times the location and number of products of all types. No need for complex documentation. Lost paperwork is a thing of the past.

The transponder is firmly connected to the tank. Long distances are no problem thanks to the 200 mm writing / reading range of the RFID antenna.

Products

Description	Order no.
RFID evaluation unit	
 RFID evaluation unit, Profibus DP interface	DTE100
RFID evaluation unit, PROFINET interface	DTE101
RFID evaluation unit, EtherNet/IP interface	DTE102
RFID evaluation unit, EtherCAT interface	DTE103
RFID evaluation unit, Ethernet TCP/IP interface	DTE104

Products

Description	Order no.
RFID antenna ANT600	
RFID antenna 13.56 MHz, M12 plug	ANT600
Mounting accessories for: ANT600	
Bracket fixture	E80335
Perforated sheet fixture	E80336
Bracket rod fixture	E80337
RFID antennas	
 RFID antenna 13.56 MHz, M12 design, flush	ANT410
RFID antenna 13.56 MHz, M12 design, non-flush	ANT411
 RFID antenna 13.56 MHz, M18 design, flush	ANT420
RFID antenna 13.56 MHz, M18 design, non-flush	ANT421
 RFID antenna 13.56 MHz, M30 design, flush	ANT430
RFID antenna 13.56 MHz, M30 design, non-flush	ANT431
 RFID antenna 125 KHz	ANT512
RFID antenna 13.56 MHz, ISO 15693	ANT513
 RFID antenna 13.56 MHz, 1 m cable, M12 plug	ANT515
RFID antenna 13.56 MHz, 2 m cable, M12 plug	ANT516
Antenna adapters	
 Adapter to increase the ranges for RFID antenna type M18	E80390
 Adapter to increase the ranges for RFID antenna type KQ	E80391
 Antenna adapter for a wider sensing field for RFID antenna type KQ	E80392
RFID transponders for: ANT410, ANT411, ANT420, ANT421, ANT430, ANT431, ANT513, ANT515, ANT516, ANT600	
ID tag/51x51/06 – 13.56 MHz, 10 pcs	E80400
ID tag holder for ID tag E80400	E80401
ID tag/M5x16.5/06 – 13.56 MHz, 10 pcs	E80347
Tag fixture for workpiece carriers with ID tag E80345, 13.56 MHz, 896 bits	E80348
ID tag/34X6.0/06 – 13.56 MHz, 1024 bits, 10 pcs	E80342
ID tag/90X34x7/06 – 13.56 MHz, 896 bits, 5 pcs	E80343
ID tag/16X3/06 – 13.56 MHz, 896 bits, 10 pcs	E80344



All in one unit: RFID antenna, evaluation and CANopen interface



RFID 13.56 MHz



Reliable identification of ID tags in workpiece carriers and products

Robust housing for assembly, conveying and handling technology

Optional alignment of the sensing face in five different positions

High protection ratings IP 67 and IP 69K for use in harsh industrial environments



Easy installation and application

The DTC510 RFID read/write doesn't need a conventional evaluation unit. This device combines RFID HF antenna, electronics and CANopen interface in one compact housing. This eliminates the need for complex wiring.

The corresponding ESD file ensures fast and easy integration into higher-level control systems with a CANopen master.

The antenna face can be aligned in five different directions. This means there are no limits to mechanical mounting. Typical applications are for example product tracking, material flow control and traceability.

Besides, the robust design with protection ratings IP 67 and IP 69K permits use in harsh industrial environments.



Application examples

Product tracking

The DTC510 can for example be used to store the number of the workpiece carrier on ID tags in production control.

This ensures that the right product is in the right place at the right time.









Material flow control

The RFID system can be used to check whether the right material is available in the required quantity and quality in the right place at the right time.

Traceability

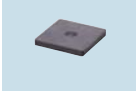
Traceability is an important tool for production control and optimisation. RFID and DTC510 provide the data that is sent to a controller or to a database.

Accessories

Type	Description	Order no.
Mounting accessories		
	Mounting plate stainless steel	E12106
	Mounting plate stainless steel	E12161
RFID tag		
	ID tag/30X2.8/03 – 13.56 Mhz, 16 Kbits – FRAM	E80370
	ID tag/30X2.5/06 – 13.56 MHz, 896 bits	E80371
	ID tag/R20X2.5/06 – 13.56 Mhz, 896 bits	E80377
	ID tag/30X2.8/03 – 13.56 MHz, 64 Kbits	E80380
	ID tag/D50X3.0/0 – 13.56 Mhz, 16 Kbits – FRAM	E80383
	ID tag/D50X3.0/0 – 13.56 MHz, 1024 bits	E80384
	ID tag/4.35X3.6/03 – 13.56 Mhz, 896 bits, 10 pcs	E80381
	ID tag/51x51/06 – 13.56 Mhz, 896 bits, 10 pcs	E80400
	ID tag/Teardrop Shape/06 – 13.56 Mhz, 896 bits, 5 pcs	E80387
	Tag fixture for workpiece carriers	E80348

The products

Type	Description	Order no.
	Read/write head, CANopen interface	DTC510

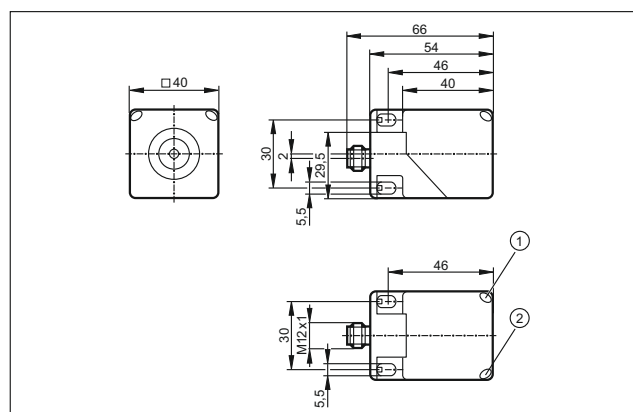

Further technical data		
Operating voltage	[V DC]	9...32
Current consumption	[mA]	≤ 50 (24 V), ≤ 80 (12 V)
Ambient temperature	[°C]	-20...60
Distance to the ID tag referred to a 30 mm disk tag	[mm]	≤ 60
Protection rating, protection class		IP 67 / IP 69K, III
Housing materials		PA, stainless steel
Connection		M12 connector; rotatable, locking

Dimensions



- 1) LED yellow
- 2) LED green
- 2) LED red

Connection technology

Type	Description	Order no.
	Socket, M12, 5 m black, PUR cable	EVC492
	Socket, M12, 10 m black, PUR cable	EVC683
	Y splitter M12 connector / 2x M12 socket	E12529



Large selection of RFID antennas with IO-Link



RFID 13.56 MHz



Nine unit versions for different applications

Flexible parameter setting, diagnostics and data handling thanks to IO-Link

Perfect for identification tasks with small data volumes

Easy visualisation of the antenna parameters with LR DEVICE or IO-Link master via the IO-Link



Applications

Thanks to the easy integration via IO-Link the new RFID antennas are suitable for a wide range of applications.

They are perfect for use for the identification of workpiece carriers in conveyor technology, as only a small amount of data needs to be transmitted.

In machine tools, magazines and moulded parts can be detected via RFID and IO-Link. This reduces cycle times and increases the production quantity.

In automotive production, body components or engines are compared to order numbers via RFID in order to control processing steps or check the final assembly.



Advantages of the RFID solutions from ifm:

ifm offers the largest product range of IO-Link sensors on the market. The new RFID antennas now complete the range.

The RFID antennas are designed for the connection to IO-Link masters. These masters offer up to eight M12 sockets for the connection of IO-Link RFID antennas.

Depending on the version, the IO-Link masters have an EtherCAT, Profibus, Ethernet TCP/IP, EtherNet/IP or PROFINET interface for communication to the PLC.

The robust design of the antennas with protection rating IP 67 and IP 69K permits use in harsh industrial environments.

All RFID tags to HF standard ISO 15693 can be used.

Data width

The process data width in the process image is 32 bytes. The user data width in the process image is 28 bytes each in the input and output.





IO-Link functions

- Upload/download of parameters for device replacement
- Reading of transponder UIDs
- Reading and writing of transponder user data

IO-Link additional functions:

- Indication of the tag presence bit
- Antenna on/off
- Data hold time adjustable

IO-Link masters

Design	Description	Order no.
StandardLine Coolant		
	Profinet 4-port	AL1100
	EtherNet/IP 4-port	AL1120
	Profinet 8-port	AL1102
	EtherNet/IP 8-port	AL1122
DataLine Coolant		
	Profinet 4-port	AL1300
	EtherNet/IP 4-port	AL1320
	EtherCat 4-port	AL1330
	Modbus TCP 4-port	AL1340
	Profinet 8-port	AL1302
	EtherNet/IP 8-port	AL1322
	EtherCat 8-port	AL1332
	Modbus TCP 8-port	AL1342

Products

Design	Description	Order no.
IO-Link RFID antennas		
	RFID antenna 13.56 MHz, M12 design, flush	DTI410
	RFID antenna 13.56 MHz, M12 design, non flush	DTI411
	RFID antenna 13.56 MHz, M18 design, flush	DTI420
	RFID antenna 13.56 MHz, M18 design, non flush	DTI421
	RFID antenna 13.56 MHz, M30 design, flush	DTI430
	RFID antenna 13.56 MHz, M30 design, non flush	DTI431
	RFID antenna 13.56 MHz, rectangular design 40 x 40 mm	DTI513
	RFID antenna 13.56 MHz, rectangular design 20 x 7 x 48 mm 1 m cable, M12 plug	DTI515
	RFID antenna 13.56 MHz, rectangular design 20 x 7 x 48 mm 2 m cable, M12 plug	DTI516
Antenna adapter		
	Adapter to increase the ranges for RFID antenna type M18	E80390
	Adapter to increase the ranges for RFID antenna type KQ	E80391
	Antenna adapter for a wider sensing field for RFID antenna type KQ	E80392
Selection RFID transponders		
	ID tag/51x51/06 – 13.56 MHz, 10 pcs	E80400
	Bracket for ID tag E80400	E80401
	ID tag/M5x16.5/06 – 13.56 MHz, 10 pcs	E80347
	Tag fixture for workpiece carriers with ID tag E80345, 13.56 MHz, 896 bits	E80348
	ID tag/34X6.0/06 – 13.56 MHz, 1024 bits, 10 pcs	E80342
	ID tag/90X34x7/06 – 13.56 MHz, 896 bits, 5 pcs	E80343
	ID tag/16X3/06 – 13.56 MHz, 896 bits, 10 pcs	E80344



Condition monitoring systems



Online condition monitoring with fieldbus interface

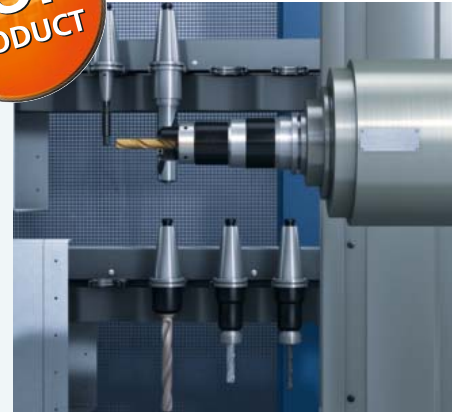

Systems for vibration monitoring and diagnostics



Fieldbus for data exchange with a PLC

Optimised condition and process monitoring

3 Ethernet ports: for separate office and machine networks

6 channels: 4x dynamic (e.g. acceleration, force), 2x analogue

Large onboard history log with real-time clock



Diagnostics



PROFINET



Laptop parameter setting

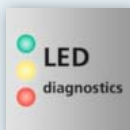

LED diagnostics



EtherNet/IP



Modbus

Extensive and customisable condition monitoring

VSE150 is a 6-channel diagnostic system designed to evaluate 4 dynamic signals (e.g. rotational acceleration) and 2 analogue inputs. The new VSE15x family provides different fieldbus interfaces to exchange data with a PLC. This makes it possible to display the measuring values directly on the control system and optimally adapt the monitoring functions to the operating states and processes of the machine. In addition to the fieldbus, 2 fast digital switching outputs (response time ≤ 1 ms) are provided for time-critical alarms.

Reduced network complexity saves time and money

The direct PLC connection via fieldbus allows auxiliary parameters (e.g. rotational speed and triggers for operating states) as well as non-time-critical alarms from condition monitoring to be exchanged over the bus. This not only reduces wiring complexity but also saves the cost of providing the corresponding inputs/outputs on the PLC.



Process-optimised condition monitoring

Machines with varying processes such as machine tools have high demands on condition monitoring systems. To recognise deterioration in quality at an early stage and avoid scrap or even damage, a process-dependent detection of even the smallest change is necessary. This can only be achieved by interlinking the operating parameters (e.g. rotational speed, power consumption, feed rate, tool) and the vibration data – ideally in the PLC. This combination of control and condition monitoring data enables process-dependent monitoring, leading to a considerable increase in quality and process reliability. The same applies to diagnosis (rolling-element bearing condition, ball screw, unbalance), where, in many cases, a high degree of diagnostic validity can only be achieved by combining the vibration monitoring data with the machine/process parameters of the PLC. Influencing process factors must be minimised and the measured data evaluated systematically. Here, too, integrating condition monitoring with the PLC is an enormous advantage and a direct fieldbus connection provides the optimal solution.

Rapid response protects machinery

If machine protection (e.g. crash monitoring) is part of the monitoring concept of a machine, a fast response is critical to minimise potential damage. Here, reaction speed is everything. For time-critical alarms, the diagnostic electronics provides two additional digital outputs. The response time of the diagnostic electronics from the time the event occurs until the switching output reacts is 1 ms. This signal can be used to initiate an immediate machine stop to protect man and machine and minimise or even completely avoid consequential damage.

Wiring diagram

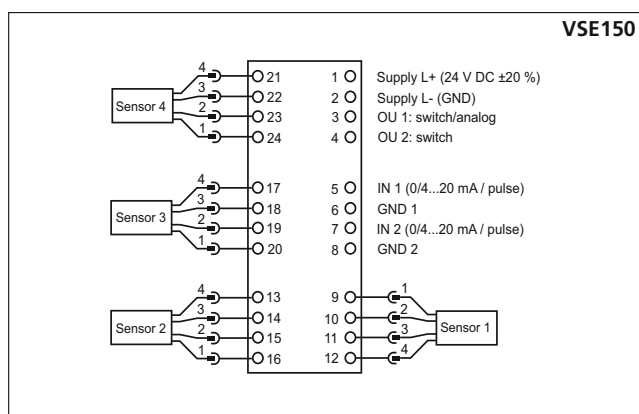



Products

Type	Description	Order no.
	Profinet IO Device Klasse C	VSE150
	Ethernet/IP	VSE151
	Modbus TCP	VSE153

Technical data		
Operating voltage	[V DC]	24, ± 20 % IEPE input 24, + 20 %
Protection rating, protection class		IP 20, III
Inputs/outputs		4 inputs dynamic, can be configured individually: 0...10 mA AC, IEPE or 0/4...20 mA DC 2 inputs static, electrically isolated: 0/4...20 mA DC or pulse (HTL) 2 digital alarm outputs (PNP 100 mA) or 1 digital output and 1 analogue output 0/4...20/22 mA
Dynamic input		16-bit resolution Frequency range 0...12,000 Hz max. sampling rate 100 kSamples/s
History memory		integrated ring memory (FIFO) with battery buffered real time clock, approx. 880,000 data sets
Ambient temperature	[°C]	0...60

Accessories

Type	Description	Order no.
	Parameter setting software	VES004
	Jumper cable Ethernet, cross-over patch cable 2 m, PVC cable, RJ45 connector / RJ45 connector	EC2080
	Jumper cable Ethernet, cross-over patch cable 5 m, PVC cable, RJ45 connector / RJ45 connector	E30112



Condition monitoring systems

Intelligent vibration monitoring – Online or handheld



Systems for vibration monitoring and diagnostics



Intelligent vibration sensor with integrated display

Measurement modi for raw data and spectral analysis

Compact design

Power supply also possible via USB

Large onboard history log with real-time clock



Diagnostics



LED

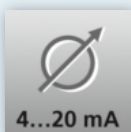

4...20 mA



IP 67



USB

New firmware with additional in-depth diagnostics using PC software

Using the new firmware for vibration sensor VN it is now possible to switch between the standard monitoring mode and the measurement mode using the PC software VES004. The measurement mode transfers the raw acceleration data to the software for analysis and recording.

It is also possible to analyse the frequency spectra (FFT, HFFT) in the software.

Compact Handheld

Using a magnet it is possible to mount the VN temporarily on the machine. The power supply from the USB interface activates the measurement mode and the measurement values (e.g. v-RMS according to ISO 10816) appear directly on the integrated display. Any deviations in the measurement values can be analysed further using the PC software on a laptop / tablet.



Online vibration monitoring

For small and average sized machines (such as motors, fans, pumps and compressors) which are often monitored manually or not at all ifm electronic now has, with the VN family, a simple and attractive alternative.

The compact VN series continually monitors the overall vibration of equipment and components according to ISO 10816. VNB211 also monitors acceleration (factory setting).

Using the analogue input it is also possible to monitor an additional process value (e.g. temperature) or a further vibration signal (VNA001).

The onboard history memory enables data logging for later trending in the PC software VES004. Parameters and limit values can be configured with the push buttons. The factory settings (basic parameters) can be changed with the PC software. In addition to online vibration monitoring the new firmware allows indepth vibration analysis.

The sensor is then switched to measurement mode granting access to the time domain (raw acceleration data). In the PC software the signal can be analysed, stored and processed further (FFT, HFFT).

This function is possible for both permanently installed units and for handheld units. In the PC software it is possible to create a tree structure which corresponds to the structure of the machine.

All measurements (history and time domain recordings) can then be assigned to the relevant measuring point using the PC software.

Wiring diagram

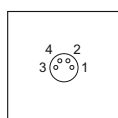

Pin 1: VCC (5 V) via USB interface
Pin 2: USB D-
Pin 3: L-
Pin 4: USB D+

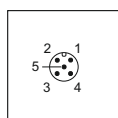

Pin 1: L+ (9.6...30 V DC)
Pin 2: Out 1 switching output or current output
0/4...20/22 mA (programmable)
Pin 3: L-
Pin 4: Out 2 switching output
Pin 5: In 0/4...20 mA

Technical data	Order no.	
	VNB001	VNB211
Operating voltage	[V DC]	9.6...30, or using USB (switching outputs not active)
Measuring range		0...500 mm/s ± 25 g
Frequency range	[Hz]	2...1000 2...6000
Accuracy (% of the final value)		± 3
Analogue input	[mA]	0/4...20 0/4...20 or VNA001
Outputs		2 switching outputs or 1 switching output and 1 analogue output (4...20 mA)
Display		4-digit alphanumeric display
Measurement principle		MEMS, capacitive
No. measurement axes		1
Data interface		USB
Ambient temperature	[°C]	-30...60
Protection rating		IP 67
History memory		Ring memory (FIFO), battery buffered real time clock, > 650.000 data records
Housing material		diecast zinc nickel-plated
Measurement method	VNB001	v-rms or v-peak, time signal
Measurement method	VNB211	vibration acceleration / vibration velocity, time signal
Parameter setting		sensor pushbuttons, PC software

Accessories

Description	Order no.
USB / M8 cable	E30136
Adapter UNF / M5	E30137
Power supply	E30080
Y connection cable, M12 plug / 2 x M12 socket	E12405
Parameter software	VES004
Acceleration sensor (for VNB211 only)	VNA001

Connection technology

Description	Order no.
Socket M12 screened, 2 m black, PUR cable, 5-pole, angled	EVC535
Socket M12 screened, 2 m black, PUR cable, 5-pole, straight	EVC532



Condition monitoring systems

New accelerometers for your machine health

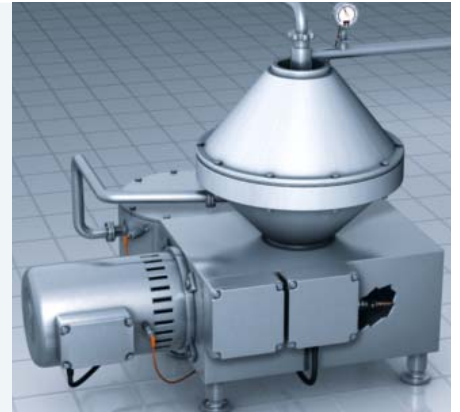

Systems for vibration monitoring and diagnostics



Piezoelectric accelerometer type VSP with IEPE interface

Wide measurement range ± 50 g

Robust designs with IP 67 or IP 68 protection rating

Also available as version for hazardous areas ATEX, IECEx

For connection to diagnostic electronics VSE



Diagnostics



IP 67



High-grade stainless steel



IP 68



Accelerometers for efficient vibration diagnostics

The acceleration signal plays an important part in the condition based monitoring of equipment and components. In contrast to other physical measurement units such as pressure and temperature it is possible to determine different characteristics which point out various symptoms (e.g. unbalance, bearing damage, cavitation, crash).

These characteristics can be evaluated and monitored in an external unit such as the ifm diagnostic electronics type VSE or other units with an IEPE (integrated electronic piezoelectric) input. IEPE is a standard interface for accelerometers and is defined using the sensitivity of the sensors, usually in mV/g (Millivolt per g, g = gravity).

The accelerometers type VSP are based on a piezoelectric measurement principle and are designed for the demanding requirements of industrial use.



Type	Measuring range [g]	Frequency range [Hz]	Protection	Ambient temperature [°C]	ATEX / IECEx approval	Order no.
------	------------------------	-------------------------	------------	-----------------------------	-----------------------	-----------

Acceleration sensors · Measuring principle: piezoelectric

	± 50	2...10,000	IP 67	-55...125	–	VSP001
	± 50	2...10,000	IP 68	-55...90	•	VSP01A
	± 50	2...10,000	IP 68	-55...90	•	VSP02A
	± 50	2...14,000	IP 67	-55...130	–	VSP003

Dimensions

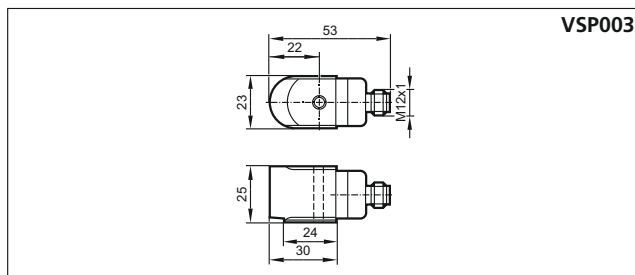

VSP003

Further technical data

Operating voltage	[V DC]	10...12
Current consumption	[mA]	0.5...8
Sensitivity	[mV/g]	100
No. measurement axes		1
Accuracy		± 5 %
Housing material		stainless steel

Wiring diagram

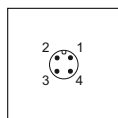



Pin 1: not used
Pin 2: L+ white
Pin 3: not used
Pin 4: 0 V black



Diagnostic electronics

Type	Description	Order no.
------	-------------	-----------

Acceleration sensors · Diagnostic electronics for vibration sensors type VSA / VSP

	Cabinet mounting; frequency selective machine monitoring of up to 4 measurement points, Ethernet interface TCP/IP, on-board time-stamped history function, 2 switching outputs or 1 switching and 1 analogue output, counter function	VSE002
	Cabinet mounting; frequency selective machine monitoring of up to 4 measurement points; Ethernet interface TCP/IP, on-board time-stamped history function, 2 switching outputs or 1 switching and 1 analogue output, 8 further freely configurable I/O, counter function	VSE100
	Cabinet mounting; frequency selective machine monitoring of up to 4 measurement points; Ethernet interface TCP/IP, on-board time-stamped history function, 2 switching outputs or 1 switching and 1 analogue output, counter function, Profinet IO	VSE150

Accessories

Type	Description	Order no.
	Safety barrier for VSP0xA	ZB0633
	Parameter setting software	VES004
	Connection cable Ethernet cross-over patch cable 5 m, PVC cable, RJ45 plug / RJ45 plug	E30112

Connection technology

Type	Description	Order no.
	Socket M12 screened, 10 m black, PUR cable, 4-pole	EVC528
	Socket M12 screened, 20 m black, PUR cable, 5-pole	EVC629
	Socket M12 screened, 30 m black, PUR cable, 5-pole	EVC561
	Socket M12 screened, 60 m black, PUR cable, 5-pole	EVC591



Systems for condition monitoring
of machines

Configurable signal lamps

TOP
PRODUCT



Systems for signalling
and indication



Perfect visibility

**Modern LED RGB technology –
long life, reduced stock-keeping**

**Different modes configurable
via IO-Link or setting menu**

**Also as standard version with
digital inputs**

Easy installation



High performance

Signal lamps are used for status indication or as warning device everywhere in factories on machines, conveyors and installations. ifm's innovative signal lamps offer several advantages over conventional signal lamps and are therefore suitable for demanding applications.

Flexible configuration

In general signal lamps must be adapted to the application. Instead of spending time and effort on screwing modules of different colours together, the new LED RGB technology makes it possible to adjust the signal lamp as needed via IO-Link or setting button (e.g. permanently on, low flash rate, high flash rate, different colours, siren). This reduces type variety and stock-keeping.



Type	Communication	Items supplied	Protection rating	Dimensions [Ø x H mm]	Order no.
5-segment signal lamp · M12 connectors					
	Digital inputs / IO-Link	Mounting base	IP 65	70 x 344	DV1500
	Digital inputs / IO-Link	Mounting base and siren	IP 54	70 x 384	DV1510
	Digital inputs / IO-Link	–	IP 65	70 x 244	DV1520
	Digital inputs / IO-Link	Siren	IP 54	70 x 284	DV1530
	IO-Link	Mounting base	IP 65	70 x 344	DV2500
	IO-Link	Mounting base and siren	IP 54	70 x 384	DV2510
	IO-Link	–	IP 65	70 x 244	DV2520
	IO-Link	Siren	IP 54	70 x 284	DV2530

Versions

The DV15xx signal lamp has digital inputs and can be configured by means of a setting button on the device. The DV25xx signal lamp can be controlled and set via IO-Link without a setting button.

For demanding environments

Neither water nor dust stick to the smooth surface of the lamp body. This prevents dirt from sticking, ensuring visibility of the signal lamp in the long run. No metallic components such as screws or connectors are exposed. This means that the lamps are particularly suited for use in the food industry and in the medical, pharmaceutical or chemical sector.

Optimum visibility

The patented technology creates a strong contrast between the light spot of the LED and the environment. This ensures optimum visibility, in particular in the event of extraneous light, for example in the vicinity of large windows.

Long life

The use of LED technology means the signal lamp has a very long life.

Adaptable

The LED RGB technology allows the signal lamp to be individualised (permanently on, low flash rate, high flash rate, different colours). This reduces type variety and stock-keeping.

The lamp can be put into different operating modes, e.g. analogue mode for level indication. 7 different signal sounds can be set for the siren.



Easy installation

A fixture is supplied with the device. In addition, a version with a mounting base is available which allows raised installation. This mounting base can be rotated by 90 degrees so that wall mounting is possible without further accessories. Moreover, accessories for pole mounting are available.



Common technical data

Operating voltage	[V DC]	18...30
Current consumption	[mA]	< 200
Ambient temperature	[°C]	-25...50
Light technology		RGB
Number of segments		5
MTTF in hours		660,000
Housing materials		ABS, PC

Accessories

Type	Description	Order no.
	Basic fixture	E89060
	Wall fixture	E89061
	Spacer pole 100 mm	E89065
	Spacer pole 300 mm	E89066
	Spacer pole 800 mm	E89067

Connection technology

Type	Description	Order no.
	Socket, M12, 8 poles, 2 m black, PUR cable	E11950
	Socket, M12, 8 poles, 5 m black, PUR cable	E11807
	Socket, M12, 8 poles, 10 m black, PUR cable	E11311
	Socket, M12, 8 poles, 15 m black, PUR cable	E11856
	Jumper M12 / M12, 1 m black, PUR cable	E12572



Systems for mobile machines

ecomatController V3 – standard and safety controller in one unit



Controllers



Powerful 32-bit triple-core controllers with large application memory in one unit

Can be used as safety controller (SIL 2 / PL d) with CANopen Safety support

Independent internal controllers with scalable I/O assignment for standard and safety applications

Two Ethernet ports with internal switch



Ethernet



CODESYS



IP 65
IP 67

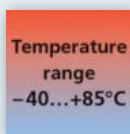

Temperature
range
-40...+85°C



SIL 2
PL d

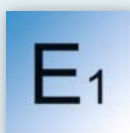

E1

Powerful standard and safety PLC in one unit

Modern vehicles and mobile machines need very powerful control electronics to process the high number of input and output signals.

That is why the new third generation ecomatController was developed. It has two independent, internal PLCs; one of them will be certified as a safety controller.

In addition to its multifunctional inputs and outputs with diagnostic capabilities, the unit features two Ethernet ports and four CAN interfaces. The CAN interfaces support all important bus protocols (CANopen, CANopen Safety and J1939) as well as the transparent and preprocessed data exchange. The control functions are easily integrated into the application program thanks to CODESYS programming (version 3.5).



Features and benefits

Sturdy mechanical design

The control electronics are integrated into a compact metal housing with front-mounted, coded central plugs for mobile use, providing all the necessary connections for inputs, outputs, communication and programming. RGB status LEDs indicate the most important system messages.

• Powerful electronics

The core of the controller, which has been designed according to the applicable standards for electronics in mobile applications, is one of the most advanced multi-core 32-bit processors with 300 MHz clock frequency. Its 6 MByte application memory includes a 1 MByte file storage system.

Two internal, independently programmable controllers allow for subdivision of the application software if required. Consequently, the safe program part can be executed without interference from the general program execution. This ensures reliable operation even with complex control functions. The controller can be used in applications up to ISO 13849 PL d and IEC 62061 SIL CL 2.*

• Configurable inputs and outputs

The inputs and outputs can be configured as digital, frequency or analogue inputs with diagnostic function or as inputs for resistance measurement. The analogue inputs enable both current and voltage measurement. The outputs can be configured as digital or PWM outputs with diagnostic capabilities, with or without current control.

All inputs and outputs can also be configured as safe channels if required. Thus, safe sensors and actuators can be directly connected and processed in the application software.

Programmable to IEC 61131-3 with CODESYS

Programming is done by means of the standardised IEC 61131-3 languages. Established and certified libraries are available for special functions and safe applications.

Maintenance, diagnosis and updates are performed using TFTP via Ethernet and the maintenance tool. Additionally, these functions can be accessed via an application interface for ifm's PDM displays and via a software development kit for customer applications.

• Interfaces with extended functionality

Besides an RS-232 interface and the Ethernet interface with internal switch, all controllers provide four CAN interfaces to ISO 11898.

All CAN interfaces support the essential bus protocols CANopen, CANopen Safety and J1939.

* Certification as safety controller in progress.

ecomatController	Order no.		
	CR711S	CR720S	CR721S
Number of inputs (can be configured)			
Analogue Multifunctional/digital	16	24	24
Frequency/digital (pos./neg. signals)	8	16	16
Resistance/digital	4	4	4
Digital	4	16	24
Sensor supply	•	•	•
Number of outputs (can be configured)			
PWMI/digital 4.0 A/ H-bridge	6	8	12
PWMI/digital 4.0 A	3	4	6
PWMI/digital 2.5 A	9	12	18
Digital 2.5 A	9	12	18
Analogue output	1	2	2

Common technical data ecomatController	
Housing	metal housing
Device connection	1 x 81-pole Tyco/AMP, 4 x M12 – CR071x 2 x 81-pole Tyco/AMP, 4 x M12 – CR072x
Protection	IP 67
Operating voltage [V DC]	8...32
Temperature range operation/storage [°C]	-40...85
Indication	8 x status LED
CAN interface	CAN ISO 11898, 20 Kbits/s...1 Mbit/s Ethernet 10/100 Mbits/s RS232 9.6...115.2 kBit/s
Protocols	CAN CANopen, SAE J 1939 or free protocol Ethernet TCP/IP, Modbus
Programming	CODESYS V 3.5
Application memory [MB]	6
Safety-related characteristics*	IEC 62061 SIL CL 2 ISO 13849-1 PL d
Standards and tests (extract)	CE, E1 (UN-ECE R10), EN 50 155

Accessories Description	Order no.
Connection cable, 58-pole, 2.5 m, plug code A	EC0710
Connection cable, 81-pole, 2.5 m, plug code A	EC0711
Connection cable, 47-pole, 2.5 m, plug code B	EC0720
Connection cable, 73-pole, 2.5 m, plug code B	EC0721
Plug unwired incl. contacts, code A	EC0701
Plug unwired incl. contacts, code B	EC0702
Ethernet cable cross-link, 2 m, M12/RJ45, PVC	E11898
CAN programming interface CANfox	EC2112
Adapter set CAN/RS232 for CANfox	EC2113



Systems for mobile machines

ioControl – rugged I/O module with integrated controller



I/O modules



I/O module for mobile use with high protection rating and DEUTSCH connectors

Can be used as independent, CODESYS-programmable mini controller

Display and keyboard interface for parameter setting

Configurable input/output function

Two CAN interfaces with CANopen and J1939 protocol

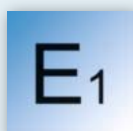
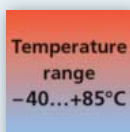

Decentralised I/O module and mini controller in one unit

ioControl is a decentralised I/O module connected to the controller via CAN bus. It is installed away from the controller on remote machine parts right where the signals are generated. The high protection rating makes it suitable for outdoor installation in wet and dirty areas.

DEUTSCH connectors, which are widely used in mobile automation, ensure an easy and safe connection of sensors and actuators. Networking of the CAN bus is effected via prewired drop cables.

ioControl can either be used as a configurable I/O module or as a mini controller in the field. CODESYS is used as a programming system.



Features and benefits

The decentralised I/O modules of the ioControl system connect binary and analogue sensors to a controller via CAN bus using the CANopen protocol. Furthermore, I/O modules provide additional functions for signal preprocessing.

The compact, glass-fibre reinforced housing features reverse-polarity protected DEUTSCH connectors suitable for mobile use, providing all the necessary connections for inputs, outputs, communication and programming. An integrated two-colour LED display with keyboard serves to indicate the most important system messages, the baud rate and the node number as well as for device configuration.

An extensive range of connection cables completes the offer.

• Configurable inputs and outputs

A high degree of flexibility is provided by the configurable inputs and outputs. There is a choice of analogue and digital inputs. The analogue inputs can be set as current inputs (0...20 mA) or voltage inputs (0...10 V / 0...32 V).

For digital and analogue I/O modules, the profile DSP 401 has been defined. The input/output functions of the module are configured via the device object directory.

• The electronics

The core of the controller, which has been designed according to the applicable standards for electronics in mobile applications, is a modern 32-bit processor. Its monitoring and protective functions enable reliable operation even under extreme operating conditions.

Programmable to IEC 61131-3 with CODESYS

Apart from their application as I/O modules, all units can also be used as freely programmable mini controllers with CANopen and J1939 among others. Programming is done via CODESYS by means of the standardised IEC 61131-3 languages, allowing the user to build the application software with ease.

In addition, libraries are available for special functions of the controller.

• Communication interfaces

ioControl is equipped with two CAN interfaces to ISO 11898 for programming and data exchange with connected modules, controllers, displays or an engine controller.

Products

ioControl	Order no.		
	CR2050	CR2051	CR2052
Number of inputs (can be configured)			
Analogue multifunctional/digital	8	–	–
Analogue multifunctional/frequency/digital	–	–	4
Frequency/digital	4	–	–
Resistance/digital	4	–	4
Number of outputs (can be configured)			
PWMi/digital 4.0 A	–	4	4
PWM/digital 4.0 A	–	4	–
PWMi/digital 2.5 A	–	4	4
PWM/digital 2.5 A	–	4	–

Common technical data ioControl		
Housing		impact-resistant polyamide
Device connection	inputs/outputs CAN interface 1 supply voltage CAN interface 2	6 poles (Deutsch DT04-6p) 6 poles (Tyco/AMP)
Protection		IP 65, IP 67
Operating voltage	[V DC]	8...32
Current consumption	[mA]	≤ 200 (without external load)
Temperature range operation/storage	[°C]	-40...85
Interfaces	CAN	2.0 A/B CiA DS 301 V4, CiA DS 401 V 1.4 ISO 11898, 20 Kbits/s...1 Mbit/s (default 250 Kbits/s)
Protocols	CAN	CANopen, SAE J 1939 or free protocol
Programming		CODESYS V 2.3
Total memory		1536 kBytes
Application memory		512 kBytes
Standards and tests (extract)		CE, E1 (UN-ECE R10), EN 50 155

Accessories

Description	Order no.
Connection cable, DT06-6P for 2 inputs, 2m	E12547
Connection cable, DT06-6P/M12 for 2 inputs, 2m	E12562
Connection cable, DT06-6P for 2 outputs, 2m	E12553
Patch cable, CAN DT06-6P/DT06-6P, 1m	EC1256
Connection cable, AMP-6P for module supply, 2m	E12565
CAN programming interface CANfox	EC2112
Adapter set CAN/RS232 for CANfox	EC2113



Connection technology



ecolink M12, A coded – now wirable for hygienic and wet areas



For use in wet areas and in the
food industry



Innovative strain relief

Highly elastic seal

**Tried-and-tested ecolink
technology**

Shock and vibration resistance

**Protection rating:
IP 65, IP 67, IP 68, IP 69K**

Easy to assemble correctly

Halogen-free and silicone-free

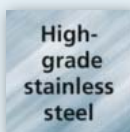
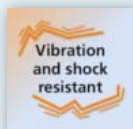

Reliably sealed – even in case of intense cable movement

A special challenge is the reliable and permanent sealing of the cable. With this innovative and patented technology, strain relief and cable seal are strictly separated from each other, the strain relief being guaranteed by means of an extremely strong three-way ball clamp that reliably clamps the cable even in case of intense tensile strain.

The highly elastic cable seal is positioned right at the cable entry so as to prevent any contamination due to penetration of dirt. The highly elastic material prevents cable sheath deformation and reliably seals even in case of intense cable movement.

Simple and safe mounting

These connectors also feature the perfectly tried-and-tested ecolink technology that allows for reliable and manual M12 connection to the device without use of tools.



Technical data:

Operating voltage:

4-pole: 250 V AC / 300 V DC

5-pole: 60 V AC / DC

Nominal current: 4 A

Protection: IP 65, IP 67, IP 68, IP 69K

In locked condition with the matching counterpart.

Protection class: II

Tightening torque threaded sleeve: 0.6...1.2 Nm

Note the maximum value of the counterpart.

For cable diameter: 3.5...6 mm

Screw terminals: 0.25 mm²...1 mm²

Ambient temperature: -25...100 °C

Materials:

Housing/moulded body: PA

Contact carrier: PA

Coupling nut: high-grade stainless steel
(316L/1.4404)

Contacts: gold-plated

Sealing ring: EPDM

Approvals:

UL approval in preparation

Applications:

Hygienic and wet areas in the food industry

Wiring diagram

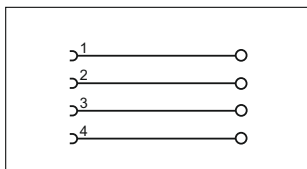

EVF565, EVF566

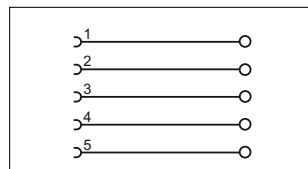

EVF569, EVF570

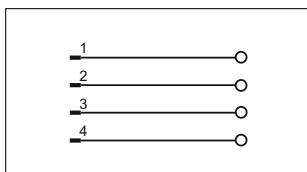

EVF567, EVF568

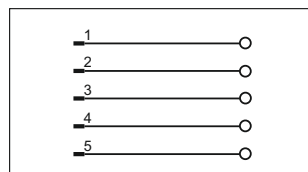

EVF571, EVF572

Products

Type	Description	Order no.
M12 socket		
	4-pole	EVF565
	5-pole	EVF569
	4-pole	EVF566
	5-pole	EVF570
M12 cable plug		
	4-pole	EVF567
	5-pole	EVF571
	4-pole	EVF568
	5-pole	EVF572

Dimensions

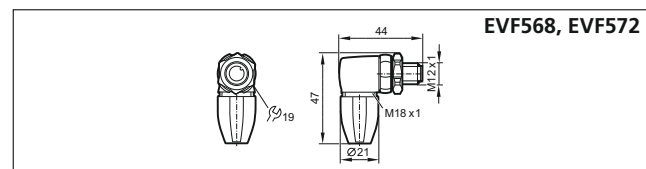
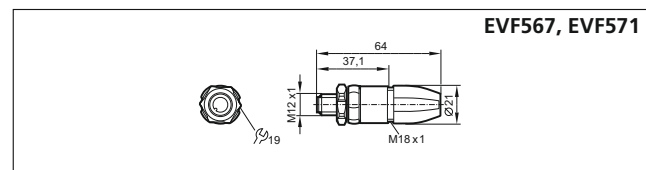
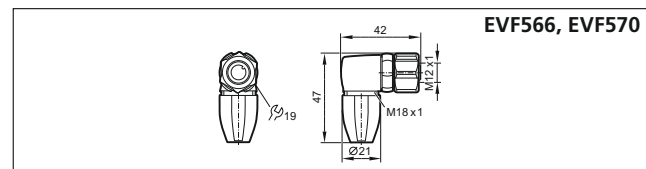
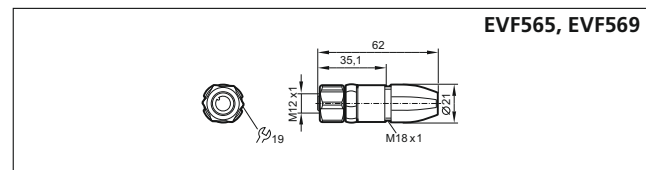



ecolink M12 cable with 1 mm² for reduced voltage drop



Use in wet areas and in the food and beverage industry



Cables with 4 x 1 mm² reduce the voltage drop

Halogen-free and silicone-free

Contoured nut with enhanced grip makes for optimum sealing even when hand tightened

The mechanical end stop protects the O-ring against destruction

Permanent vibration protection with saw tooth contour



ecolink M12 for hygienic and wet areas in the food industry

Most applications require special solutions. Only high-quality materials, safe production processes and faultless mounting lead to success in the long run.

The integrated end stop protects the O-ring against destruction caused by tightening the nut too much. Mounting and removal are carried out without tools.

The asymmetrically acting vibration protection holds the nut tight in its position, guaranteeing an optimum and permanent seal.

High-quality materials especially adapted to the application and intensive monitoring during and after production guarantee maximum quality standards.

Technical data:

Operating voltage: 250 V AC / 300 V DC
 Nominal current: 4 A
 Protection: IP 67, IP 68, IP 69K
 In locked condition with the matching counterpart.
 Tightening torque nut: 0.6...1.5 Nm
 Note the maximum value of the counterpart.
 Ambient temperature: -25...100 °C
 Vibration / shock: 750 g, 1 million cycles

Materials:

Housing / moulded body: PP
 Contact carrier: PA 6.6
 Coupling nut: high-grade stainless steel (316L / 1.4404)
 Contacts: gold-plated
 Sealing ring: EPDM
 Cable: MPPE halogen-free, silicone-free, 4 x 1 mm² (32 x Ø 0.2 mm), Ø 6.2 mm

Approvals:

cCSAus in preparation

Applications:

Hygienic and wet areas in the food industry

Dimensions

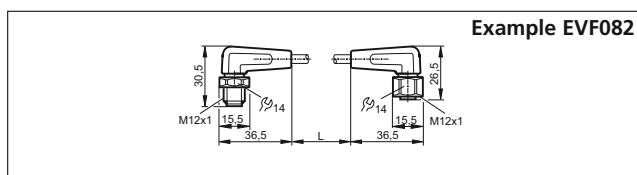
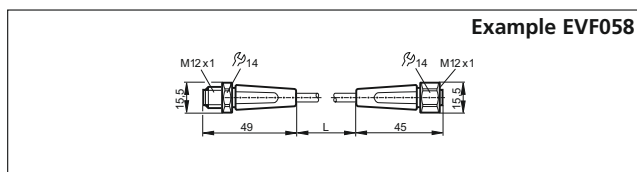

Wiring diagram

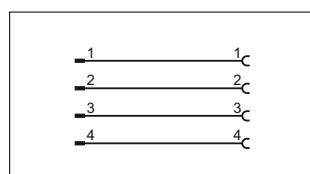
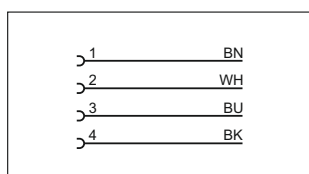

The products

Type	Description	Order no.
M12 sockets - 4-pole		
	2.0 m	EVF480
	5.0 m	EVF481
	10.0 m	EVF482
	20.0 m	EVF483
	50.0 m	EVF484
	2.0 m	EVF485
	5.0 m	EVF486
	10.0 m	EVF487
	20.0 m	EVF488
	50.0 m	EVF489
Jumper - M12 / M12 - 4-pole		
	0.25 m	EVF490
	0.5 m	EVF491
	1.0 m	EVF492
	2.0 m	EVF493
	5.0 m	EVF494
	10.0 m	EVF495
	20.0 m	EVF496
	0.25 m	EVF497
	0.5 m	EVF498
	1.0 m	EVF499
	2.0 m	EVF500
	5.0 m	EVF501
	10.0 m	EVF502
	20.0 m	EVF503
	0.25 m	EVF504
	0.5 m	EVF505
	1.0 m	EVF506
	2.0 m	EVF507
	5.0 m	EVF508
	10.0 m	EVF509
	20.0 m	EVF510
	0.25 m	EVF511
	0.5 m	EVF512
	1.0 m	EVF513
	2.0 m	EVF514
	5.0 m	EVF515
	10.0 m	EVF516
	20.0 m	EVF517



ecolink M12 Ethernet D-Code for hygienic and wet areas



Use in wet areas and in the
food and beverage industry



Halogen-free and silicone-free

Contoured nut with enhanced grip makes for optimum sealing even when hand tightened

Permanent vibration protection with saw tooth contour

**Protection rating:
IP 65, IP 67, IP 68, IP 69K**

**Ethernet CAT 5 / CAT 5e
(star quad)**

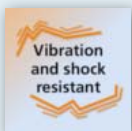

ecolink M12 for hygienic and wet areas in the food industry

Most applications require special solutions. Only high-quality materials, safe production processes and faultless mounting lead to success in the long run.

The asymmetrically acting vibration protection holds the threaded sleeve in its position, guaranteeing an optimum and permanent seal.

High-quality materials especially adapted to the application and intensive monitoring during and after production guarantee maximum quality standards.



Technical data:

Operating voltage: 50 V AC / 60 V DC
 Ethernet: M12 D-Code, CAT 5 / CAT 5e
 Nominal current: 4 A
 Protection: IP 65, IP 67, IP 68, IP 69K
 In locked condition with the matching counterpart.
 Tightening torque threaded sleeve: 0.6...1.2 Nm
 Note the maximum value of the counterpart.
 Ambient temperature: -25...80 °C
 Drag chain: > 1 million cycles

Materials:

Housing / moulded body: PP
 Contact carrier: PP
 Coupling nut: high-grade stainless steel
 (316L / (1.4404))
 Contacts: gold-plated
 Cable: MPPE halogen-free, silicone-free,
 4 x 0.34 mm² (7 x 0.25 mm), Ø 6.5 mm



Approvals:

UL approval in preparation

Applications:

Hygienic and wet areas in the food industry

The products

Type	Description	Order no.
M12 sockets - 4-pole		
	2.0 m	EVF518
	5.0 m	EVF519
	10.0 m	EVF520
	20.0 m	EVF521
	50.0 m	EVF522
Jumper - M12 / M12 - 4-pole		
	0.25 m	EVF528
	0.5 m	EVF529
	1.0 m	EVF530
	2.0 m	EVF531
	5.0 m	EVF532
	10.0 m	EVF533
	20.0 m	EVF534

Dimensions

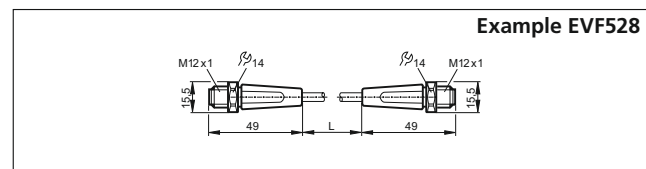
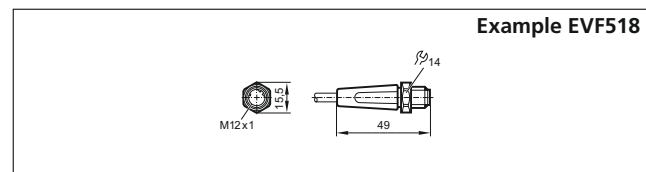

Wiring diagram

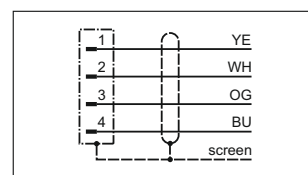

Example EVF518

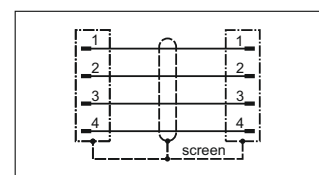

Example EVF528



ecolink M12 – new Y splitters for special applications



Use in wet areas and in the
food and beverage industry



Halogen-free and silicone-free

Contoured nut with enhanced grip makes for optimum sealing even when hand tightened

The mechanical end stop protects the O-ring against destruction

Permanent vibration protection with saw tooth contour

LEDs clearly visible even under bright lighting



Vibration
and shock
resistant



IP 67
IP 68
IP 69 K



Operating
temperature
up to
100°C

ecolink M12 for hygienic and wet areas in the food industry

Most applications require special solutions. Only high-quality materials, safe production processes and faultless mounting lead to success in the long run.

The integrated end stop protects the O-ring against destruction caused by tightening the nut too much. Mounting and removal are carried out without tools.

The asymmetrically acting vibration protection holds the nut tight in its position, guaranteeing an optimum and permanent seal.

High-quality materials especially adapted to the application and intensive monitoring during and after production guarantee maximum quality standards.



Technical data:

Operating voltage: 60 V AC / DC
with LED: 10...36 V DC

Nominal current: 4 A

Protection: IP 65, IP 67, IP 68, IP 69K
In locked condition with the matching counterpart.

Tightening torque nut: 0.6...1.5 Nm
Note the maximum value of the counterpart.

Ambient temperature: -25...100 °C

Vibration / shock: 750 g, 1 million cycles

Materials:

Housing / moulded body: PP

Contact carrier: PA 6.6

Coupling nut: high-grade stainless steel
(316L / (1.4404))

Contacts: gold-plated

Sealing ring: EPDM

Cable: MPPE halogen-free, silicone-free,
4-pole: 4 x 0.34 mm², Ø 4.9 mm
5-pole: 5 x 0.34 mm², Ø 5.1 mm

Approvals:

cCSAus in preparation

Applications:

Hygienic and wet areas in the food industry

Wiring diagram

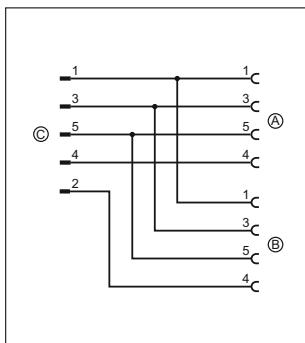

Example EVF329

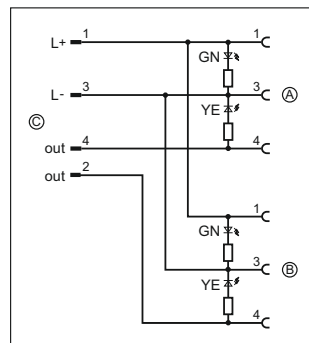

Example EVF335

The products

Type	Description	Order no.
1 x M12 male, 2 x M12 female		
	1.0 m	EVF329
	2.0 m	EVF330
	5.0 m	EVF331
	1.0 m	EVF332
	2.0 m	EVF333
	5.0 m	EVF334
	1.0 m, LED	EVF335
	2.0 m, LED	EVF336
	5.0 m, LED	EVF337

Dimensions

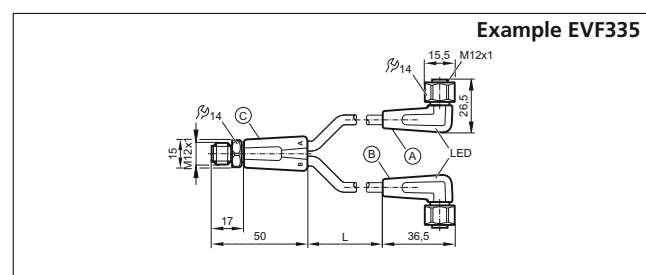
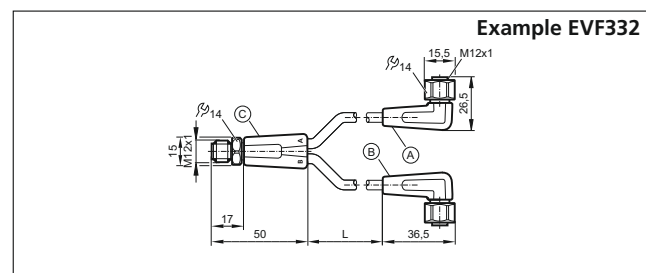
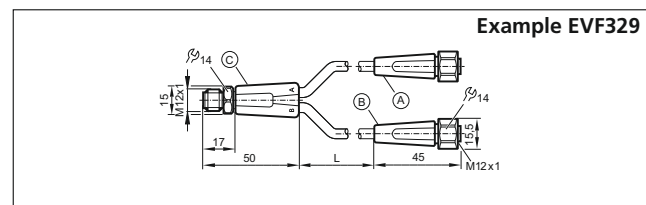

The ifm sales platform



Overview:

The ifm product range is clearly structured and the individual product platforms ensure quick orientation.

Selectors:

Choose between the most important technical data and you will get the product selection suitable for your requirements.

Compare:

You can compare the technical data of up to 3 products. Differences are marked in colour.

Search and find:

Enter the search term in the full text search and get suggestions for products, topics and product groups.

Order:

We provide a quick-order and csv import function for the shopping basket on the product pages.

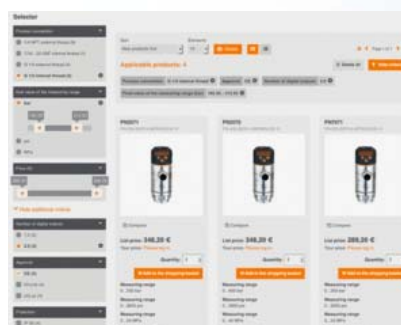

More clarity

For each product group you can make a first selection via the platforms.

A clear visual language and explanatory texts give you a first impression of the products.

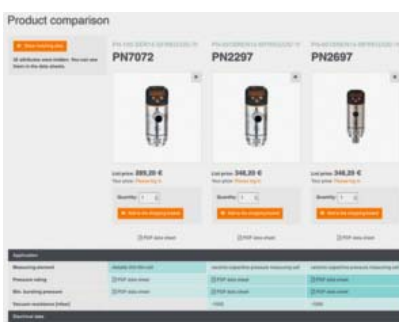

Compare products with each other

The selectors are the heart of the product search. The displayed selection criteria are adapted to each product range and the technical features of the products. The results can be displayed as tiles or lists.



Easy purchasing

You are in control of everything in the shopping basket: quantity, modes of shipment and payment. We provide you with everything you can expect from a modern shop.

Customers relying on long-standing tried-and-tested articles can quickly order by entering the article number in the shopping basket. This saves time, in particular when a product has to be quickly reordered.

Navigation in the menu structure is no longer necessary.

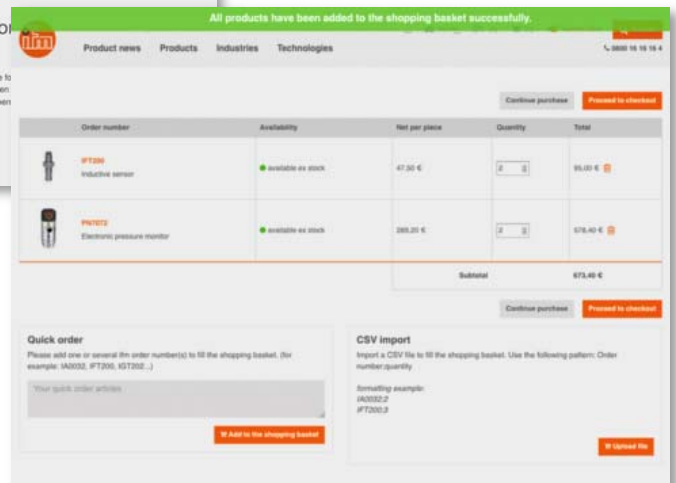
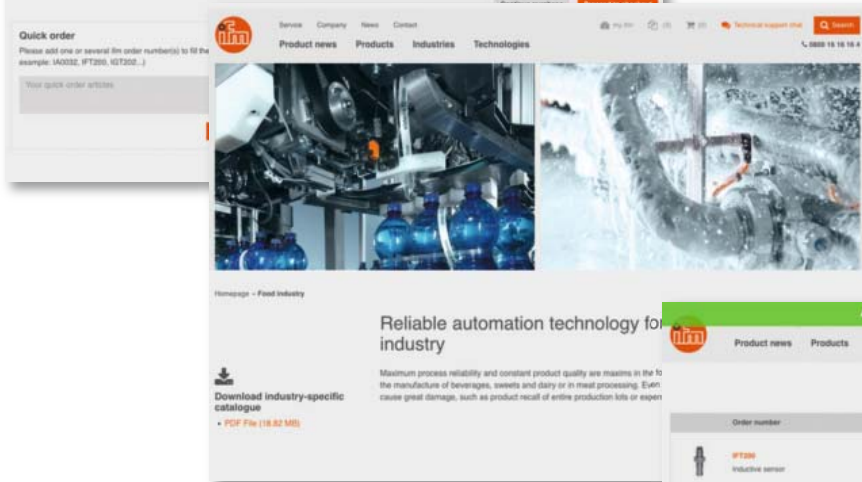

For all types of display

Whether PC, laptop, tablet or smartphone – the design of the sales platform adapts to any screen size thus increasing user-friendliness. This also makes it possible to buy products using mobile equipment such as a smartphone.

Try us.
Click here to directly get to our homepage:
www.ifm.com





Visit our website:
www.ifm.com

ifm – close to you!



Position sensors



Sensors for motion control



Industrial imaging



Safety technology



Process sensors



Industrial communication



IO-Link



Identification systems



Condition monitoring systems



Systems for mobile machines



Connection technology



Software



Power supplies



Accessories



ifm electronic gmbh
 Friedrichstraße 1
 45128 Essen
 Tel. +49 / 201 / 24 22-0
 Fax +49 / 201 / 24 22-1200
 E-mail info@ifm.com

